

# SONY®

LCD Digital Colour TV

Operating Instructions

KDL-32L40xx  
KDL-26L40xx  
KDL-19L40xx

# BRAVIA

# NOTICE FOR CUSTOMERS IN THE UNITED KINGDOM

A moulded plug complying with BS1363 is fitted to this equipment for your safety and convenience.

Should the fuse in the plug supplied need to be replaced with the same rating of fuse approved by ASTA or BSI to BS 1362 (i.e., marked with ⚡ or ⚡) must be used.

When an alternative type of plug is used it should be fitted with the same rating of fuse, otherwise the circuit should be protected by a 10 AMP FUSE at the distribution board.

If the plug supplied with this equipment has a detachable fuse cover, be sure to attach the fuse cover after you change the fuse. Never use the plug without the fuse cover. If you should lose the fuse cover, please contact your nearest Sony service station.

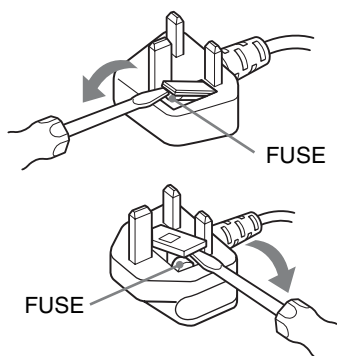

## How to replace the fuse

Open the fuse compartment with a blade screwdriver, and replace the fuse.

Please refer to the illustration that actually equipped with the product.

## Introduction

Thank you for choosing this Sony product. Before operating the TV, please read this manual thoroughly and retain it for future reference.

## Notice for Digital TV function

- Any functions related to Digital TV (DVB) will only work in countries or areas where DVB-T (MPEG2) digital terrestrial signals are broadcasted. Please confirm with your local dealer if you can receive a DVB-T signal where you live.
- Although this TV set follows DVB-T specifications, compatibility with future DVB-T digital terrestrial broadcasts cannot be guaranteed.
- Some Digital TV functions may not be available in some countries.

The manufacturer of this product is Sony Corporation, 1-7-1 Konan Minato-ku Tokyo, 108-0075 Japan. The Authorized Representative for EMC and product safety is Sony Deutschland GmbH, Hedelfinger Strasse 61, 70327 Stuttgart, Germany. For any service or guarantee matters please refer to the addresses given in separate service or guarantee documents.

## Trademark information

- DVB is a registered trademark of the DVB Project
- HDMI, the HDMI logo and High-Definition Multimedia Interface are trademarks or registered trademarks of HDMI Licensing LLC.

**HDMI**<sup>™</sup>  
HIGH-DEFINITION MULTIMEDIA INTERFACE

## About the model name in this manual

The “xx” that appears on the model name, corresponds to two numeric digits related to design or colour variation.

# Table of Contents

## Start-up Guide

4

Safety information.....	8
Precautions.....	10
Overview of the remote .....	11
Overview of the TV buttons and indicators .....	12

## Watching TV

Watching TV .....	13
Checking the Digital Electronic Programme Guide (EPG) <b>DVB</b> .....	16
Using the Digital Favourite list <b>DVB</b> .....	17

## Using Optional Equipment

Connecting optional equipment .....	18
Viewing pictures from connected equipment .....	19
Using control for HDMI .....	20

## Using MENU Functions

Navigating through menus.....	21
Picture Adjustment menu.....	22
Sound Adjustment menu.....	24
Features menu.....	25
Set-up menu .....	27
Digital Set-up menu .....	30

## Additional Information

Installing the Accessories (Wall-Mount Bracket).....	32
Specifications .....	35
Troubleshooting .....	37

**DVB** : for digital channels only

# Start-up Guide

## 1: Checking the accessories

- Remote RM-ED014 (1)
- Size AA batteries (R6 type) (2)
- Stand (1)
- Screws for stand (3)
- Cable band (1)

### To insert batteries into the remote

Push and slide to open.

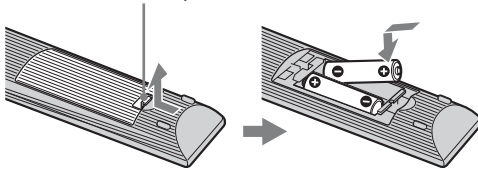

- Observe the correct polarity when inserting batteries.
- Do not use different types of batteries together or mix old and new batteries.
- Dispose of batteries in an environmentally friendly way. Certain regions may regulate disposal of batteries. Please consult your local authority.
- Handle the remote with care. Do not drop or step on it, or spill liquid of any kind onto it.
- Do not place the remote in a location near a heat source, a place subject to direct sunlight, or a damp room.

## 2: Attaching the stand

Follow the assembling steps required to place on a TV stand.

- 1 Take out the Table-Top Stand and screws from the carton. The screws are found in the accessory bag.

### KDL-32L40xx/KDL-26L40xx

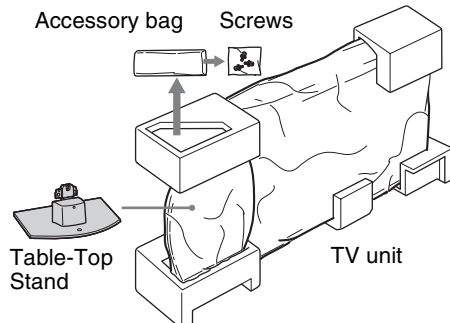

### KDL-19L40xx

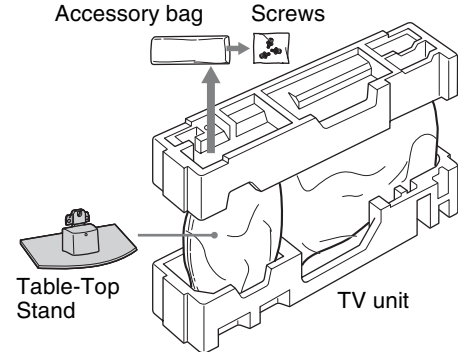

- 2 Gently slide the TV unit onto the neck of the Table-Top Stand and align the screws holes.

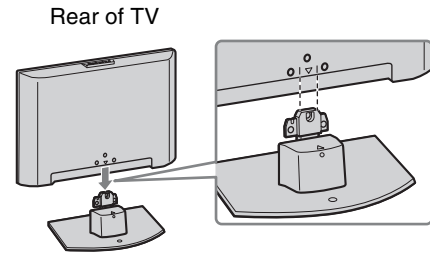

- When you carry the TV, place your hand as illustrated and hold it securely, see page 8. Do not put stress on the LCD panel and the frame around the screen.
- Be careful not to pinch your hands or the mains lead when you install the TV to the Table-Top Stand.

- 3 Use the supplied screws to attach the TV unit to the Table-Top Stand.

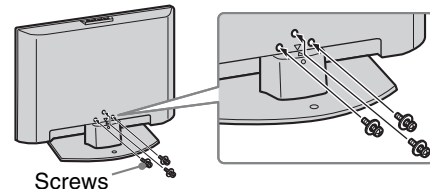

- If an electric screw driver is used, set the torque to tighten at approximately 1.5 N·m {15 kgf·cm}.
- Unless otherwise stated, illustrations here are for KDL-32L40xx.

# 3: Connecting an aerial/VCR/ DVD recorder

## Connecting an aerial only

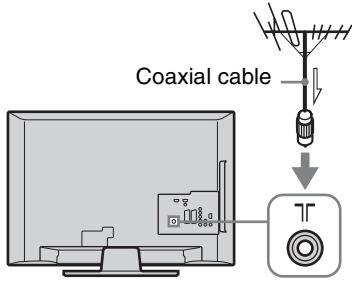

## Connecting an aerial/ VCR/ DVD recorder with SCART

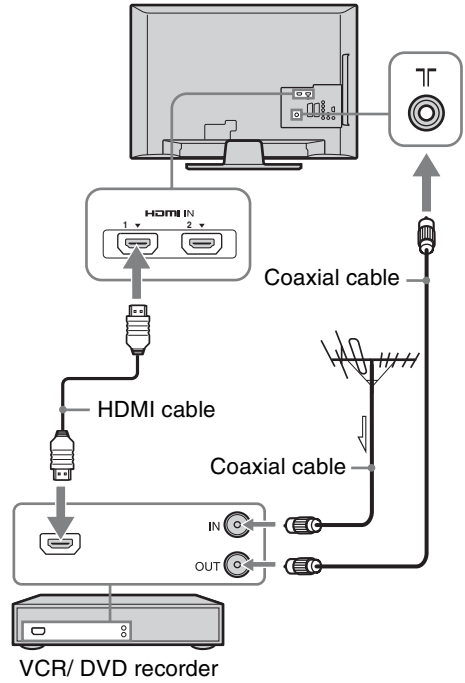
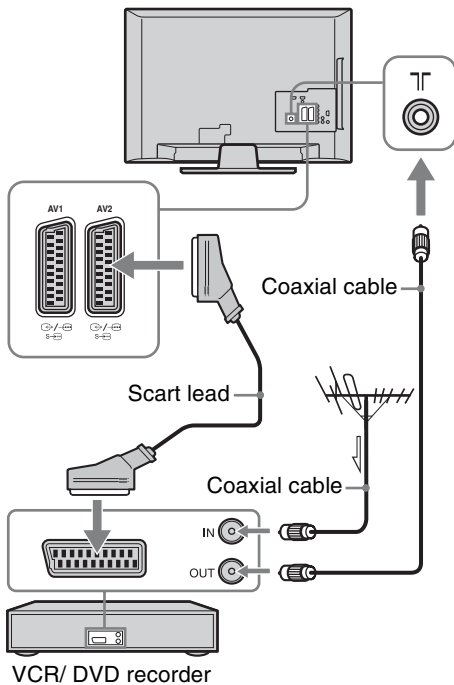

- AV1 outputs available only for analogue TV.
- AV2 outputs to the current screen (except PC, HDMI1,2, Component 1080i).

This product has been tested and found to compliant with the limits set out in the EMC Directive for using connection cables not longer than 3 meters (9.8 feet).

## 4: Preventing the TV from toppling over

KDL-32L40xx, KDL-26L40xx only

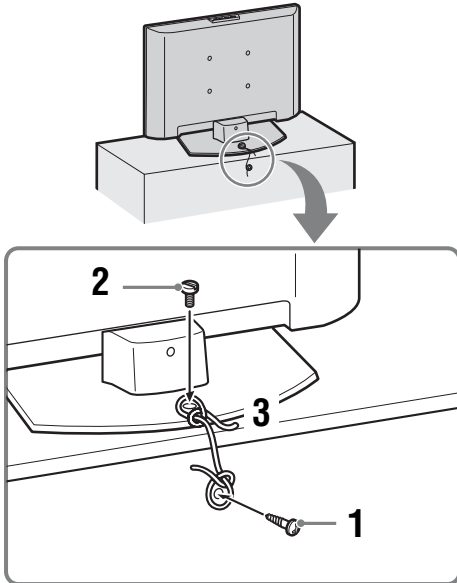

- 1 Install a wood screw (4 mm in diameter, not supplied) in the TV stand.
- 2 Install a machine screw (M6 × 12-14 mm, not supplied) into the screw hole of the TV.
- 3 Tie the wood screw and the machine screw with a strong cord.

## 5: Bundling the cables

You can bundle the connecting cables as illustrated below.

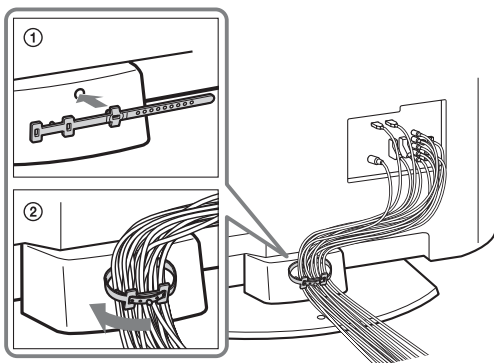

Do not bundle the mains lead with other connecting cables.

## 6: Selecting the language, country/region and location

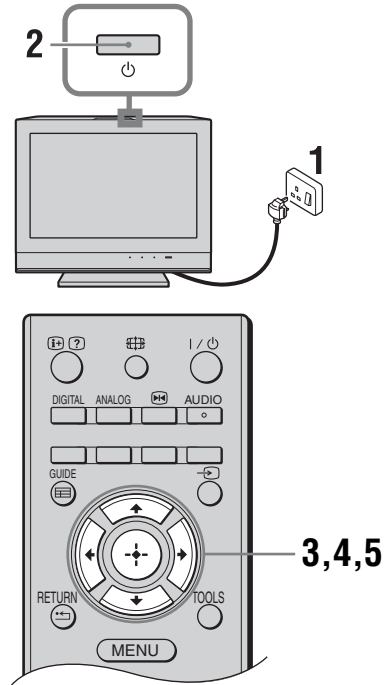

- 1 Connect the TV to your mains socket (220-240V AC, 50Hz).
- 2 Press on the top edge of the TV. When you turn on the TV for the first time, the Language menu appears on the screen.
- 3 Press to select the language displayed on the menu screens, then press .

Auto Start-up

Language	English
Country	Nederlands
Location	Français
	Italiano
	Deutsch
	Ελληνικά
	Türkçe
	Español

Select: Confirm:

- 4 Press  $\uparrow/\downarrow$  to select the country/region in which you will operate the TV, then press  $\oplus$ .

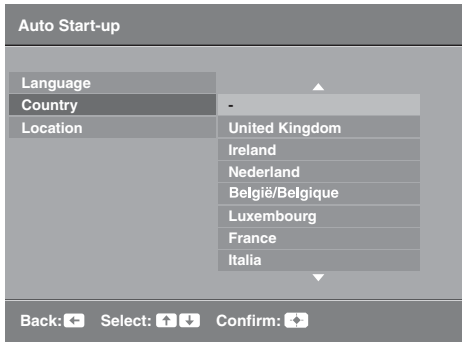

If the country/region which you want to use on the TV does not appear in the list, select “-” instead of a country/region.

- 5 Press  $\uparrow/\downarrow$  to select the location type in which you will operate the TV, then press  $\oplus$ .

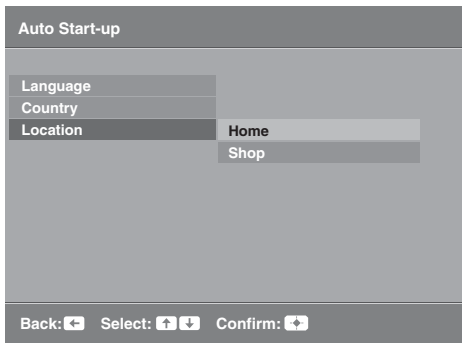

This option selects the initial picture mode appropriate for the typical lighting condition in these environments.

## 7: Auto-tuning the TV

- 1 Before you start auto-tuning the TV, insert a pre-recorded tape into the VCR connected to the TV (page 5) and start play back.  
The video channel will be located and stored on the TV during auto-tuning.  
If no VCR is connected to the TV, skip this step.

- 2 Press  $\oplus$ .

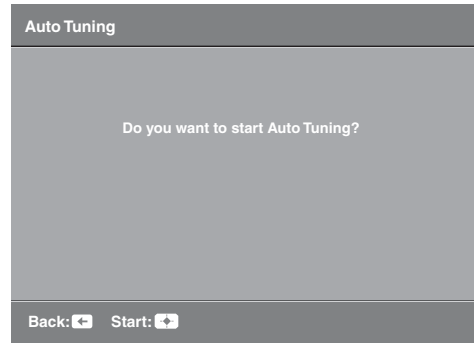

The TV starts searching for all available digital channels, followed by all available analogue channels. This may take some time, so do not press any buttons on the TV or remote while proceeding.

**If a message appears for you to confirm the aerial connection**

No digital or analogue channels were found. Check all the aerial connections and press  $\oplus$  to start auto-tuning again.

- 3 When the Programme Sorting menu appears on the screen, follow the steps of “Programme Sorting” (page 27).

If you do not change the order in which the analogue channels are stored on the TV, go to next step.

- 4 Press MENU to exit.

The TV has now tuned in all the available channels.

## Detaching the Table-Top Stand from the TV



Do not remove the Table-Top Stand for any reason other than to wall-mount the TV.

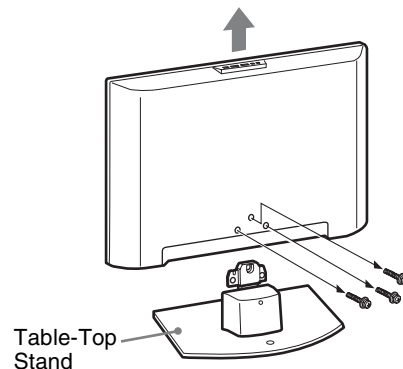

# Safety information

## Installation/Set-up

Install and use the TV set in accordance with the instructions below in order to avoid any risk of fire, electrical shock or damage and/or injuries.

### Installation

- The TV set should be installed near an easily accessible mains socket.
- Place the TV set on a stable, level surface.
- Only qualified service personnel should carry out wall installations.
- For safety reasons, it is strongly recommended that you use Sony accessories, including:

#### **KDL-32L40xx:**

- Wall-mount bracket SU-WL500

#### **KDL-26L40xx/KDL-19L40xx:**

- Wall-mount bracket SU-WL100

- Be sure to use the screws supplied with the Wall-mount bracket when attaching the mounting hooks to the TV set.

The supplied screws are designed so that they are 8 mm to 12 mm in length when measured from the attaching surface of the mounting hook.

The diameter and length of the screws differ depending on the Wall-mount bracket model. Use of screws other than those supplied may result in internal damage to the TV set or cause it to fall, etc.

8-12 mm

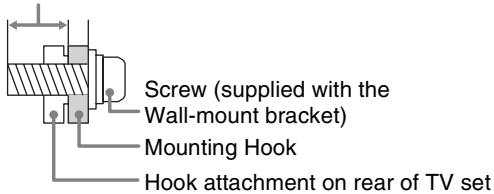

## Transporting

- Before transporting the TV set, disconnect all cables.
- Two or more people are needed to transport a large TV set.
- When transporting the TV set by hand, hold it as shown below. Do not put stress on the LCD panel and the frame around the screen.
- When lifting or moving the TV set, hold it firmly from the bottom.
- When transporting the TV set, do not subject it to jolts or excessive vibration.
- When transporting the TV set for repairs or when moving, pack it using the original carton and packing material.

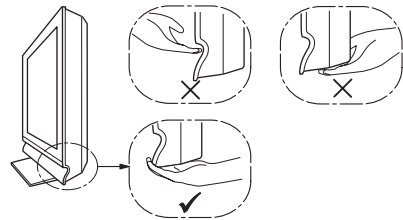
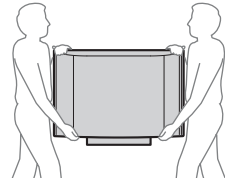

## Ventilation

- Never cover the ventilation holes or insert anything in the cabinet.
- Leave space around the TV set as shown below.
- It is strongly recommended that you use a Sony wall-mount bracket in order to provide adequate air-circulation.

### Installed on the wall

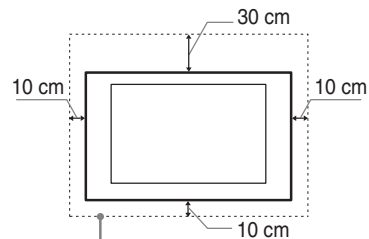

Leave at least this space around the set.

### Installed with stand

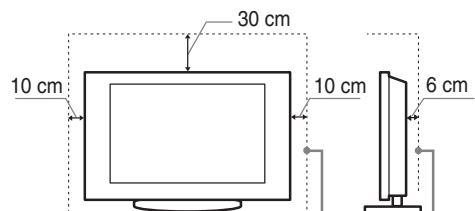

Leave at least this space around the set.



- To ensure proper ventilation and prevent the collection of dirt or dust:
  - Do not lay the TV set flat, install upside down, backwards, or sideways.
  - Do not place the TV set on a shelf, rug, bed or in a closet.
  - Do not cover the TV set with a cloth, such as curtains, or items such as newspapers, etc.
  - Do not install the TV set as shown below.

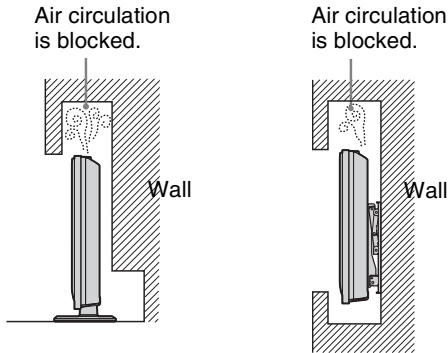

## Mains lead

Handle the mains lead and socket as follows in order to avoid any risk of fire, electrical shock or damage and/or injuries:

- Use only mains leads supplied by Sony, not other suppliers.
- Insert the plug fully into the mains socket.
- Operate the TV set on a 220-240 V AC supply only.
- When wiring cables, be sure to unplug the mains lead for your safety and take care not to catch your feet on the cables.
- Disconnect the mains lead from the mains socket before working on or moving the TV set.
- Keep the mains lead away from heat sources.
- Unplug the mains plug and clean it regularly. If the plug is covered with dust and it picks up moisture, the insulation may deteriorate, which could result in a fire.

## Notes

- Do not use the supplied mains lead on any other equipment.
- Do not pinch, bend, or twist the mains lead excessively. The core conductors may be exposed or broken.
- Do not modify the mains lead.
- Do not put anything heavy on the mains lead.
- Do not pull on the mains lead itself when disconnecting the mains lead.
- Do not connect too many appliances to the same mains socket.
- Do not use a poor fitting mains socket.

## Prohibited Usage

Do not install/use the TV set in locations, environments or situations such as those listed below, or the TV set may malfunction and cause a fire, electrical shock, damage and/or injuries.

### Location:

Outdoors (in direct sunlight), at the seashore, on a ship or other vessel, inside a vehicle, in medical institutions, unstable locations, near water, rain, moisture or smoke.

### Environment:

Places that are hot, humid, or excessively dusty; where insects may enter; where it might be exposed to mechanical vibration, near flammable objects (candles, etc).

The TV set shall not be exposed to dripping or splashing and no objects filled with liquids, such as vases, shall be placed on the TV.

### Situation:

Do not use when your hands are wet, with the cabinet removed, or with attachments not recommended by the manufacturer. Disconnect the TV set from mains socket and aerial during lightning storms.

## Broken pieces:

- Do not throw anything at the TV set. The screen glass may break by the impact and cause serious injury.
- If the surface of the TV set cracks, do not touch it until you have unplugged the mains lead. Otherwise electric shock may result.

## When not in use

- If you will not be using the TV set for several days, the TV set should be disconnected from the mains for environmental and safety reasons.
- As the TV set is not disconnected from the mains when the TV set is just turned off, pull the plug from the mains to disconnect the TV set completely.
- However, some TV sets may have features that require the TV set to be left in standby to work correctly. The instructions in this manual will inform you if this applies.

## For children

- Do not allow children to climb on the TV set.
- Keep small accessories out of the reach of children, so that they are not mistakenly swallowed.

## If the following problems occur...

**Turn off** the TV set and unplug the mains lead immediately if any of the following problems occur. Ask your dealer or Sony service centre to have it checked by qualified service personnel.

### When:

- Mains lead is damaged.
- Poor fitting of mains socket.
- TV set is damaged by being dropped, hit or having something thrown at it.
- Any liquid or solid object falls through openings in the cabinet.

# Precautions

## Viewing the TV

- View the TV in moderate light, as viewing the TV in poor light or during long period of time, strains your eyes.
- When using headphones, adjust the volume so as to avoid excessive levels, as hearing damage may result.

## LCD Screen

- Although the LCD screen is made with high-precision technology and 99.99% or more of the pixels are effective, black dots may appear or bright points of light (red, blue, or green) may appear constantly on the LCD screen. This is a structural property of the LCD screen and is not a malfunction.
- Do not push or scratch the front filter, or place objects on top of this TV set. The image may be uneven or the LCD screen may be damaged.
- If this TV set is used in a cold place, a smear may occur in the picture or the picture may become dark. This does not indicate a failure. These phenomena disappear as the temperature rises.
- Ghosting may occur when still pictures are displayed continuously. It may disappear after a few moments.
- The screen and cabinet get warm when this TV set is in use. This is not a malfunction.
- The LCD screen contains a small amount of liquid crystal. Some fluorescent tubes used in this TV set also contain mercury. Follow your local ordinances and regulations for disposal.

## Handling and cleaning the screen surface/cabinet of the TV set

Be sure to unplug the mains lead connected to the TV set from mains socket before cleaning.

To avoid material degradation or screen coating degradation, observe the following precautions.

- To remove dust from the screen surface/cabinet, wipe gently with a soft cloth. If dust is persistent, wipe with a soft cloth slightly moistened with a diluted mild detergent solution.
- Never use any type of abrasive pad, alkaline/acid cleaner, scouring powder, or volatile solvent, such as alcohol, benzene, thinner or insecticide. Using such materials or maintaining prolonged contact with rubber or vinyl materials may result in damage to the screen surface and cabinet material.
- When adjusting the angle of the TV set, move it slowly so as to prevent the TV set from moving or slipping off from its table stand.

## Optional Equipment

Keep optional components or any equipment emitting electromagnetic radiation away from the TV set. Otherwise picture distortion and/or noisy sound may occur.

## Disposal of the TV set



### Disposal of Old Electrical & Electronic Equipment (Applicable in the European Union and other European countries with separate collection systems)

This symbol on the product or on its packaging indicates that this product shall not be treated as household waste. Instead it shall be handed over to the applicable collection point for the recycling of electrical and electronic equipment. By ensuring this product is disposed of correctly, you will help prevent potential negative consequences for the environment and human health, which could otherwise be caused by inappropriate waste handling of this product. The recycling of materials will help to conserve natural resources. For more detailed information about recycling of this product, please contact your local Civic Office, your household waste disposal service or the shop where you purchased the product.



### Disposal of waste batteries (applicable in the European Union and other European countries with separate collection systems)

This symbol on the battery or on the packaging indicates that the battery provided with this product shall not be treated as household waste. On certain batteries this symbol might be used in combination with a chemical symbol. The chemical symbols for mercury (Hg) or lead (Pb) are added if the battery contains more than 0.0005% mercury or 0.004% lead. By ensuring these batteries are disposed of correctly, you will help prevent potentially negative consequences for the environment and human health which could otherwise be caused by inappropriate waste handling of the battery. The recycling of the materials will help to conserve natural resources. In case of products that for safety, performance or data integrity reasons require a permanent connection with an incorporated battery, this battery should be replaced by qualified service staff only. To ensure that the battery will be treated properly, hand over the product at end-of-life to the applicable collection point for the recycling of electrical and electronic equipment. For all other batteries, please view the section on how to remove the battery from the product safely. Hand the battery over to the applicable collection point for the recycling of waste batteries. For more detailed information about recycling of this product or battery, please contact your local Civic Office, your household waste disposal service or the shop where you purchased the product.

# Overview of the remote

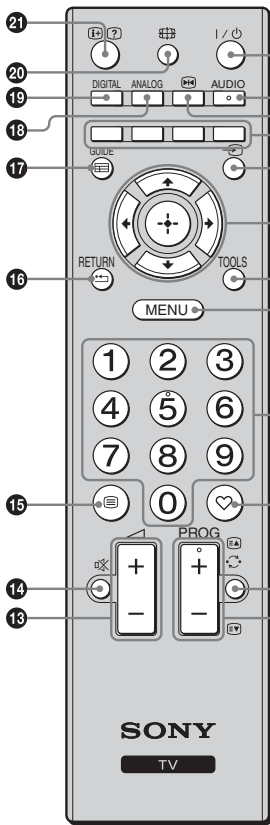

- 1** – **TV standby**  
Turns the TV on and off from standby mode.
- 2** **AUDIO**  
In analogue mode: Press to change the dual sound mode (page 24).
- 3** – **Picture freeze (page 14)**  
Freezes the TV picture.
- 4** **Coloured buttons (page 14, 17)**
- 5** – **Input select**  
Selects the input source from equipment connected to the TV sockets (page 19).
- 6**
- 7** **TOOLS (page 15, 19)**  
Enables you to access various viewing options and change/make adjustments according to the source and screen format.
- 8** **MENU (page 21)**
- 9** **Number buttons**
  - In TV mode: Selects channels. For channel numbers 10 and above, press the second and third digit in quick succession.
  - In Text mode: Enters the three digit page number to select the page.
- 10** – **Digital Favourite list**  
Press to display the Digital Favourite list that you have specified (page 17).
- 11** – **Previous channel**  
Returns to the previous channel watched.
- 12** **PROG +/-/EA/ETV**
  - In TV mode: Selects the next (+) or previous (-) channel.
  - In Text mode (page 14): Selects the next (EA) or previous (ETV) page.
- 13** – **Volume**
- 14** – **Mute the sound**
- 15** – **Text (page 14)**
- 16** **RETURN /**   
Returns to the previous screen of any displayed menu.
- 17** **GUIDE / – EPG (Digital Electronic Programme Guide) (page 16)**
- 18** **ANALOG – Analogue mode (page 13)**
- 19** **DIGITAL – Digital mode (page 13)**
- 20** – **Screen mode (page 14)**
- 21** – **Info / Text reveal**
  - In digital mode: Displays brief details of the programme currently being watched.
  - In analogue mode: Displays information such as current channel number and screen format.
  - In Text mode (page 14): Reveals hidden information (e.g. answers to a quiz).



The number 5, PROG + and AUDIO buttons have tactile dots. Use the tactile dots as references when operating the TV.

# Overview of the TV buttons and indicators

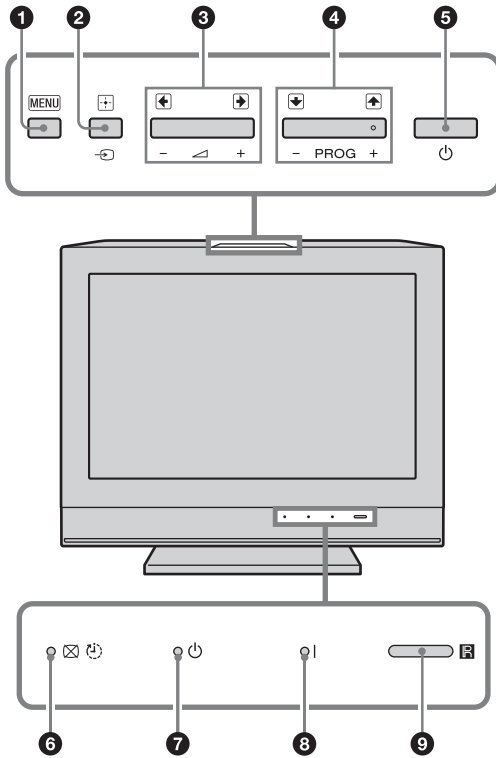

## 1 MENU (page 21)

## 2 – Input select / OK

- In TV mode: Selects the input source from equipment connected to the TV sockets (page 19).
- In TV menu: Selects the menu or option, and confirms the setting.

## 3 +/- / /

- In TV mode: Increases (+) or decreases (-) the volume.
- In TV menu: Moves through the options right () or left ()

## 4 PROG +/- / /

- In TV mode: Selects the next (+) or previous (-) channel.
- In TV menu: Moves through the options up () or down ()

## 5 – Power

Turns the TV on or off.



- To disconnect the TV completely, pull the plug from the mains.
- When you turn on the TV, the power indicator flashes in green.

## 6 – Picture Off / Sleep Timer indicator

- Lights up in green when the picture is switched off (page 25).
- Lights up in orange when the sleep timer is set (page 26).

## 7 – Standby indicator

Lights up in red when the TV is in standby mode.

## 8 – Power indicator

Lights up in green when the TV is turned on.

## 9 Remote control sensor

- Receives IR signals from the remote.
- Do not put anything over the sensor, as its function may be affected.





Make sure that the TV is completely turned off before unplugging the mains lead. Unplugging the mains lead while the TV is turned on may cause the indicator to remain lit or may cause the TV to malfunction.

# Watching TV

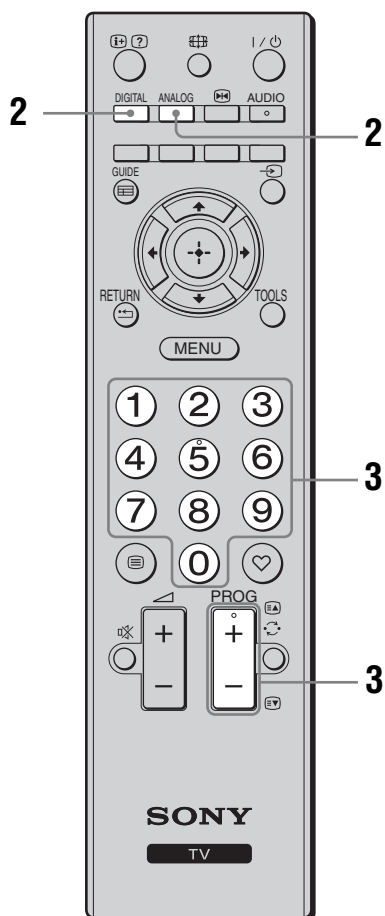
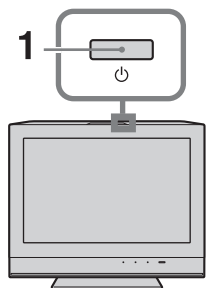
## Watching TV



- 1 Press  on the top edge of the TV to turn on the TV.

When the TV is in standby mode (the  (standby) indicator on the TV front panel is red), press  on the remote to turn on the TV.

- 2 Press DIGITAL to switch to digital mode, or ANALOG to switch to analogue mode. The channels available vary depending on the mode.









- 3 Press the number buttons or PROG +/- to select a TV channel.

To select channel numbers 10 and above using the number buttons, press the second and third digits in quick succession.





To select a digital channel using the Digital Electronic Programme Guide (EPG), see page 16.

### In digital mode

An information banner appears briefly. The following icons may be indicated on the banner.

- : Interactive service is available (MHEG Digital Text)
- : Interactive service (MHEG Digital Text) is currently disabled
- : Radio service
- : Scrambled/Subscription service
- : Multiple audio languages available
- : Subtitles available
- : Subtitles available for the hearing impaired
- : Recommended minimum age for current programme (from 4 to 18 years)
- : Parental Lock

### Additional operations

To	Do this
Adjust the volume	Press  + (increase)/ - (decrease).
Access the Programme index table (in analogue mode only)	Press  . To select an analogue channel, press  , then press  .

## To access Text

Press . Each time you press , the display changes cyclically as follows:  
Text → Text over the TV picture (mix mode) → No Text (exit the Text service)  
To select a page, press the number buttons or /  
.  
To reveal hidden information, press .



When four coloured items appear at the bottom of the Text page, Fastext is available. Fastext allows you to access pages quickly and easily. Press the corresponding coloured button to access the page.

## Picture Freeze

Freezes the TV picture (e.g. to make a note of a telephone number or recipe).

- 1 Press on the remote control.
- 2 Press again to return to normal TV mode.



Not available for Component, HDMI1, HDMI2 and PC input.

## To change the screen format manually to suit the broadcast

Press repeatedly to select the desired screen format.

### Smart\*

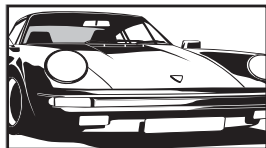

Displays conventional 4:3 broadcasts with an imitation wide screen effect. The 4:3 picture is stretched to fill the screen.

### 4/3

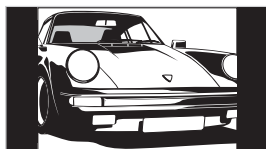

Displays conventional 4:3 broadcasts (e.g. non-wide screen TV) in the correct proportions.

### Wide (KDL-32L40xx/KDL-26L40xx only)

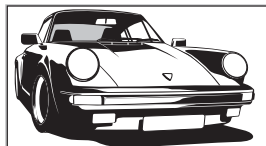

Displays wide screen (16:9) broadcasts in the correct proportions.

### Zoom\* (KDL-32L40xx/KDL-26L40xx only)

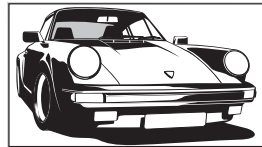

Displays cinemascopic (letter box format) broadcasts in the correct proportions.

### 14/9\*

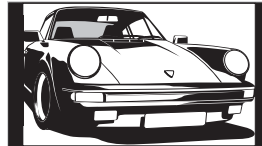

Displays 14:9 broadcasts in the correct proportions. As a result, black border areas are visible on the screen.

### Subtitle\*

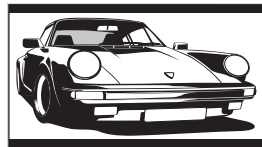

Displays cinemascopic (letter box format) broadcasts with subtitles on the screen.

### Wide (KDL-19L40xx only)

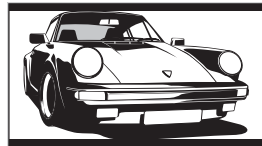

Displays 16:9 broadcasts in the correct proportions. As a result, black border areas are visible on the screen.

### Zoom (KDL-19L40xx only)

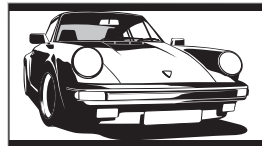

Displays 4:3 cinemascopic (letter box format) broadcasts in the correct proportions. As a result, black border areas are visible on the screen.

### Auto

- “Screen Format” is set to “Auto”, automatically changes the screen format to suit the broadcast signal.
- “Auto” is available for PAL and SECAM signals only.

\* Parts of the top and bottom of the picture may be cut off.



- Depending on the signal, some screen formats may not be selectable.
- Some characters and/or letters at the top and the bottom of the picture may not be visible in “Smart”.



You can adjust the vertical position of the picture when selecting “Smart”, “Zoom” or “14/9”. Press / to move up or down (e.g. to read subtitles).

## Using the Tools menu

Press TOOLS to display the following options when viewing a TV programme.

<b>Options</b>	<b>Description</b>
Close	Closes the Tools menu.
Picture Mode	See page 22.
Sound Effect	See page 24.
Speaker	See page 24.
Audio Language (in digital mode only)	See page 31.
Subtitle Setting (in digital mode only)	See page 31.
Sleep Timer	See page 26.
Power Saving	See page 25.
System Information (in digital mode only)	Displays the system information screen.

# Checking the Digital Electronic Programme Guide (EPG) DV3\*

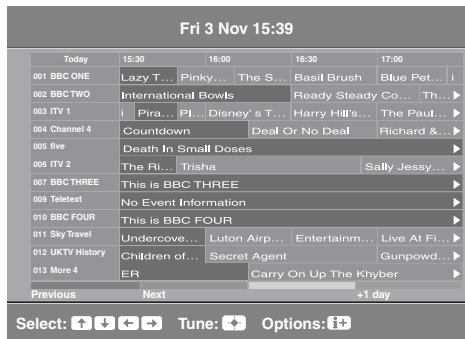

- 1 In digital mode, press GUIDE.
- 2 Perform the desired operation as shown in the following table or displayed on the screen.

## Digital Electronic Programme Guide (EPG)

\* This function may not be available in some countries/regions.

To	Do this
Watch a programme	Press $\uparrow/\downarrow/\leftarrow/\rightarrow$ to select the programme, then press $\oplus$ .
Turn off the EPG	Press GUIDE.



If an age restriction for programmes has been selected, a message asking for a PIN code will appear on the screen. For details, see “Parental Lock” on page 31.



# Using the Digital Favourite list DV3\*



Digital Favourite list

\* This function may not be available in some countries/regions.

To	Do this
Create your Favourite list for the first time	<ol style="list-style-type: none"> <li>1 Press <math>\oplus</math> to select "Yes".</li> <li>2 Press the yellow button to select the Favourite list.</li> <li>3 Press <math>\uparrow/\downarrow</math> to select the channel you want to add, then press <math>\oplus</math>. Channels that are stored in the Favourite list are indicated by a <math>\heartsuit</math> symbol.</li> <li>4 Press RETURN to finish setting up.</li> </ol>
Watch a channel	<ol style="list-style-type: none"> <li>1 Press the yellow button to navigate through your Favourite lists.</li> <li>2 Press <math>\uparrow/\downarrow</math> to select the channel, then press <math>\oplus</math>.</li> </ol>
Turn off the Favourite list	Press RETURN.
Add or remove channels in the currently edited Favourite list	<ol style="list-style-type: none"> <li>1 Press the blue button.</li> <li>2 Press the yellow button to select the Favourite list you want to edit.</li> <li>3 Press <math>\uparrow/\downarrow</math> to select the channel you want to add or remove, then press <math>\oplus</math>.</li> </ol>
Remove all channels from the current Favourite list	<ol style="list-style-type: none"> <li>1 Press the blue button.</li> <li>2 Press the yellow button to select the Favourite list you want to edit.</li> <li>3 Press the blue button.</li> <li>4 Press <math>\leftarrow/\rightarrow</math> to select "Yes", then press <math>\oplus</math> to confirm.</li> </ol>

The Favourite feature allows you to specify up to four lists of your favourite programmes.

- 1 In digital mode, press  $\heartsuit$ .
- 2 Perform the desired operation as shown in the following table or displayed on the screen.

# Using Optional Equipment

## Connecting optional equipment

You can connect a wide range of optional equipment to your TV. Connecting cables are not supplied.

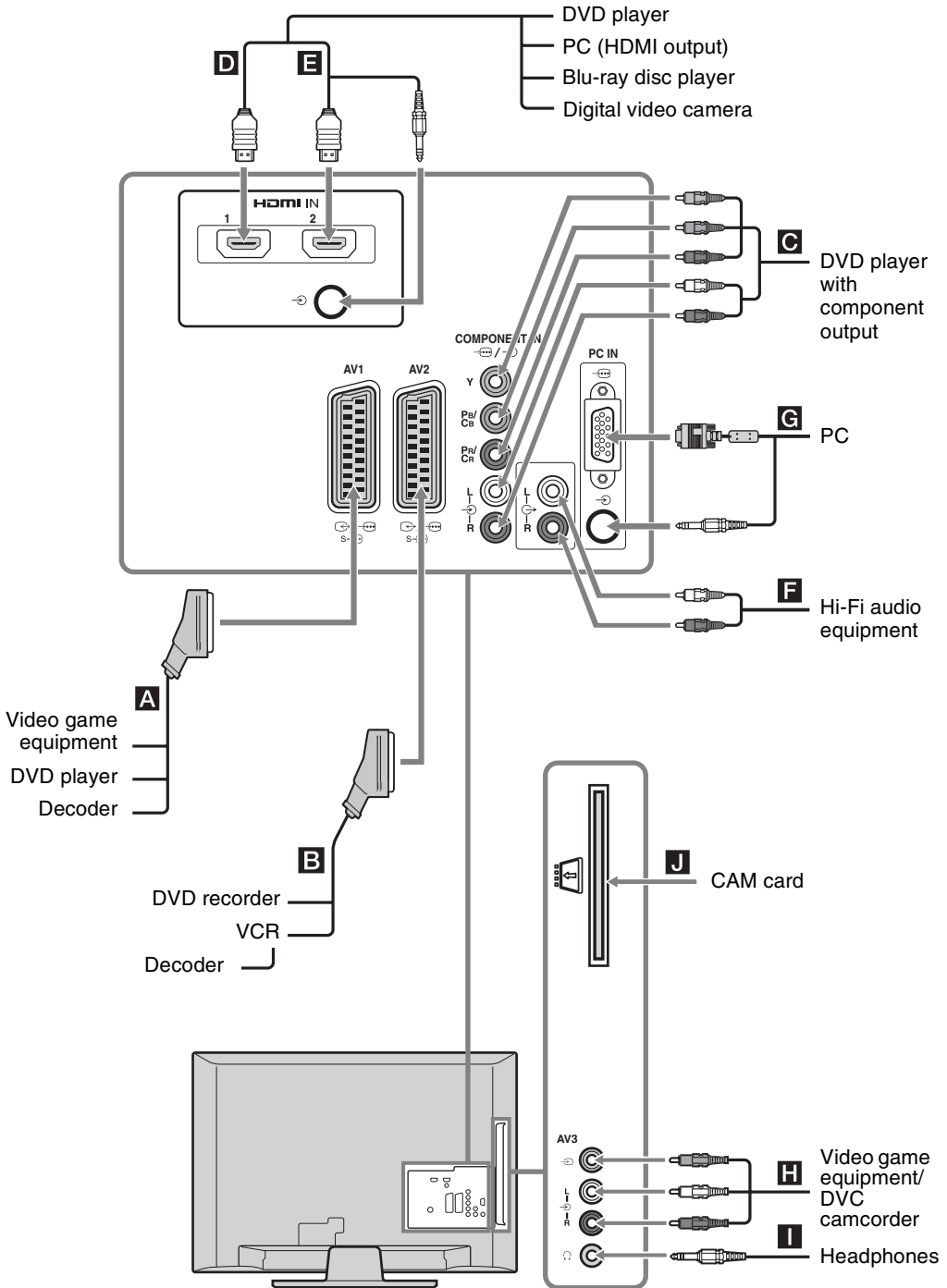

# Viewing pictures from connected equipment

Turn on the connected equipment, then perform one of the following operation.

## For an auto-tuned VCR (page 7)

In analogue mode, press PROG +/-, or the number buttons, to select the video channel.

## For other connected equipment

Press to display the connected equipment list. Press to select the desired input source, then press . (The highlighted item is selected if two seconds pass without any operation after pressing .)

Symbol on the screen	Description
AV1/ AV1	To see the equipment connected to <b>A</b> .
AV2/ AV2	To see the equipment connected to <b>B</b> .
Component	To see the equipment connected to <b>C</b> .
HDMI1	HDMI IN 1*. To see the equipment connected to <b>D</b> .
HDMI2	HDMI IN 2*. To see the equipment connected to <b>E</b> . If the equipment has a DVI socket, connect the DVI socket to the HDMI IN 2 socket through a DVI-HDMI adaptor interface (not supplied), and connect the equipment's audio out sockets to the audio in sockets in the HDMI IN 2 sockets.
AV3	To see the equipment connected to <b>F</b> .

\*

- Be sure to use only an authorized HDMI cable bearing the HDMI logo. We recommend that you use a Sony HDMI cable.
- When HDMI control compatible equipment is connected, communication with the connected equipment is supported. Refer to page 20 to set up this communication.

Symbol on the screen	Description
PC	To see the equipment connected to <b>G</b> .  It is recommended to use a PC cable with ferrites like the "Connector, D-sub 15" (ref. 1-793-504-11, available in Sony Service Centre), or equivalent.

To connect	Do this
Headphones <b>I</b>	Connect to the  socket to listen to sound from the TV on headphones.
Conditional Access Module (CAM) <b>J</b>	To use Pay Per View services. For details, refer to the instruction manual supplied with your CAM. To use the CAM, remove the "dummy" card from the CAM slot. Turn off the TV when inserting your CAM into the CAM slot. When you do not use the CAM, we recommend that the "dummy" card be inserted and kept in the CAM slot.  CAM is not supported in some countries/regions. Check with your authorized dealer.
Hi-Fi audio equipment <b>F</b>	Connect to the audio output sockets  to listen to the sound from the TV on Hi-Fi audio equipment.

## Additional operations

To	Do this
Return to normal TV mode	Press DIGITAL or ANALOG.
Access the Digital Favourites (in digital mode only)	Press . For details, see page 17.

## Using the Tools menu

Press TOOLS to display the following options when viewing pictures from connected equipment.

Options	Description
Close	Closes the Tools menu.
Picture Mode (except PC input mode)	See page 22.
Display Mode (in PC input mode only)	See page 22.
Sound Effect	See page 24.
Speaker	See page 24.

*Continued*

Options	Description
Horizontal Shift (in PC input mode only)	See page 25.
Vertical Shift (in PC input mode only)	See page 25.
Sleep Timer (except PC input mode)	See page 26.
Power Saving	See page 25.

## Using control for HDMI

The control for HDMI function enables the TV to communicate with the connected equipment that is compatible with the function, using HDMI CEC (Consumer Electronics Control). For example, by connecting Sony equipment that is compatible with control for HDMI (with HDMI cables), you can control them together.

Be sure to connect the equipment correctly, and make the necessary settings.

### To make the control for HDMI settings

The control for HDMI settings must be set on both the TV side and connected equipment side. See “HDMI Set-up” on page 28 for the TV side settings. For settings on the connected equipment, refer to the operating instructions for that equipment.

### Control for HDMI functions

- Turns the connected equipment off interlocked with the TV.
- Turns the TV on interlocked with the connected equipment and automatically switches the input to the equipment when the equipment starts to play.

# Using MENU Functions

## Navigating through menus

“MENU” allows you to enjoy various convenient features of this TV. You can easily select channels or inputs sources and change the settings for your TV.

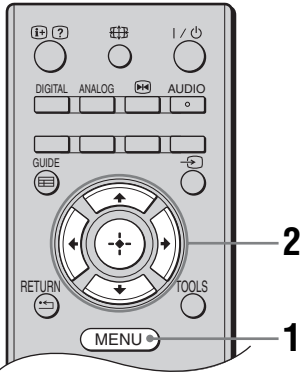

- 1 Press MENU.
- 2 Press  $\uparrow/\downarrow$  to select an option, then press  $\oplus$ .  
To exit the menu, press MENU.

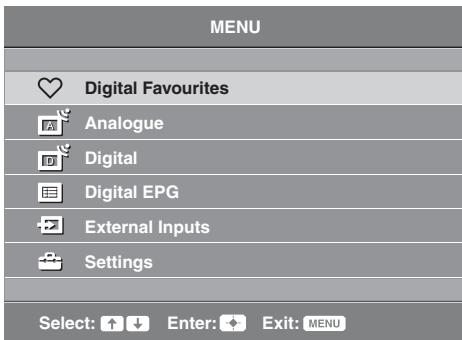

- 1 **Digital Favourites\***  
Displays the Favourite list (page 17).
- 2 **Analogue**  
Returns to the last viewed analogue channel.
- 3 **Digital\***  
Returns to the last viewed digital channel.
- 4 **Digital EPG\***  
Displays the Digital Electronic Programme Guide (EPG) (page 16).

### 5 External Inputs

Selects equipment connected to your TV.

- To watch the desired external input, select the input source, then press  $\oplus$ .

### 6 Settings

Displays the “Settings” menu where most of the advanced settings and adjustments are performed.

1 Press  $\uparrow/\downarrow$  to select a menu icon, then press  $\oplus$ .

2 Press  $\uparrow/\downarrow/\leftarrow/\rightarrow$  to select an option or adjust a setting, then press  $\oplus$ .





For details about settings, see page 22 to 31.







The options you can adjust vary depending on the situation. Unavailable options are greyed out or not displayed.

\* This function may not be available in some countries/regions.

# Picture Adjustment menu

Picture Adjustment		
	Picture Mode	Standard
	Backlight	5 <input type="text"/>
	Contrast	Max <input type="text"/>
	Brightness	50 <input type="text"/>
	Colour	50 <input type="text"/>
	Hue	0 <input type="text"/>
	Sharpness	15 <input type="text"/>
	Colour Tone	Warm
	Noise Reduction	Medium
	MPEG Noise Reduction	Medium
	Reset	

Back:  Select:   Enter:  Exit: MENU

You can select the options listed below on the “Picture Adjustment” menu. To select options in “Settings”, see “Navigating through menus” (page 21).

---

## Picture Mode

Selects the picture mode except for PC input source.

“**Vivid**”: For enhanced picture contrast and sharpness.

“**Standard**”: For standard picture. Recommended for home entertainment.

“**Cinema**”: For viewing film-based content. Most suitable for viewing in a theatre-like environment. This picture setting was developed in collaboration with Sony Pictures Entertainment to faithfully reproduce movies as intended by their creators.

## Display Mode (only in PC mode)

Selects the display mode for PC input source.

“**Video**”: For video images.

“**Text**”: For text, charts or tables.

---

## Backlight

Adjusts the brightness of the backlight.

---

## Contrast

Increases or decreases picture contrast.

---

## Brightness

Brightens or darkens the picture.

---

## Colour

Increases or decreases colour intensity.

---

## Hue

Increases or decreases the green tones and red tones.



“Hue” can only be adjusted for an NTSC colour signal (e.g., U.S.A. video tapes).

---

## Sharpness

Sharpens or softens the picture.

---

## Colour Tone

Adjusts the whiteness of the picture.

“**Cool**”: Gives the white colours a blue tint.

“**Neutral**”: Gives the white colours a neutral tint.

“**Warm**”: Gives the white colours a red tint.



“Warm” can not be selected when you set “Picture Mode” to “Vivid”.

---

---









<b>Noise Reduction</b>	Reduces the picture noise (snowy picture) in a weak broadcast signal. “ <b>High/Medium/Low</b> ”: Modifies the effect of the noise reduction. “ <b>Off</b> ”: Turns off the “Noise Reduction” feature.
<b>MPEG Noise Reduction</b>	Reduces the picture noise in MPEG-compressed video.
<b>Reset</b>	Resets all “Picture Adjustment” settings except “Picture Mode” and “Display Mode” (only in PC mode) to the factory settings.





---



“Brightness”, “Colour”, “Hue” and “Sharpness” are not available when “Picture Mode” is set to “Vivid” or when “Display Mode” is set to “text”.

# Sound Adjustment menu

Sound Adjustment		
	Sound Effect	Standard
	Surround	Off
	Treble	0 <input type="text"/>
	Bass	0 <input type="text"/>
	Balance	0 <input type="text"/>
	Reset	
	Dual Sound	Mono
	Auto Volume	On
	Speaker	TV Speaker

Back:  Select:   Enter:  Exit: MENU

You can select the options listed below on the “Sound Adjustment” menu. To select options in “Settings”, see “Navigating through menus” (page 21).

---

## Sound Effect

Selects the sound mode.

“**Standard**”: Enhances clarity, detail, and sound presence.

“**Dynamic**”: Intensifies clarity and sound presence for better intelligibility and musical realism.

“**Clear Voice**”: Makes voice sound clearer.

---

## Surround

Selects the surround mode.

“**Surround**”: For surround sound (for stereo programmes only).

“**Simulated Stereo**”: Adds a surround-like effect to mono programs.

“**Off**”: For normal stereo or mono reception.

---

## Treble

Adjusts higher-pitched sounds.

---

## Bass

Adjusts lower-pitched sounds.

---

## Balance

Emphasizes left or right speaker balance.

---

## Reset

Resets all the “Sound Adjustment” settings to the factory settings.

---

## Dual Sound

Selects the sound from the speaker for a stereo or bilingual broadcast.

“**Stereo**”, “**Mono**”: For a stereo broadcast.

“**A**”/“**B**”/“**Mono**”: For a bilingual broadcast, select “A” for sound channel 1, “B” for sound channel 2, or “Mono” for a mono channel, if available.



If you select other equipment connected to the TV, set “Dual Sound” to “Stereo”, “A” or “B”.

---

## Auto Volume

Keeps a constant volume level even when volume level gaps occur (e.g., adverts tend to be louder than programmes).

---

## Speaker

Turns on/off the TV’s internal speakers.

“**TV Speaker**”: The TV speakers are turned on in order to listen to the TV’s sound through the TV speakers.

“**Audio System**”: The TV speakers are turned off in order to listen to the TV’s sound only through your external audio equipment connected to the audio output sockets.



“Sound Effect”, “Surround”, “Treble”, “Bass”, “Balance”, “Reset” and “Auto Volume” are not available when “Speaker” is set to “Audio System”.



# Features menu

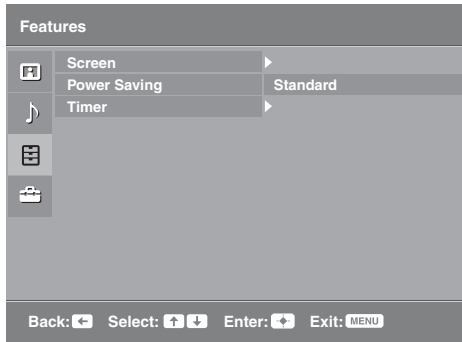

You can select the options listed below on the “Features” menu. To select options in “Settings”, see “Navigating through menus” (page 21).

## Screen

Changes the screen format.

### Screen Format

For details about the screen format, see page 14.



“Auto” is available for PAL and SECAM signals only.

“**Normal**”: Displays the picture in its original size.

“**Full**”: Enlarges the picture to fill the display area.

## Screen (only in PC mode)

## Power Saving

Selects the power saving mode to reduce the power consumption of the TV.

“**Standard**”: Default settings.

“**Reduce**”: Reduces the power consumption of the TV.

“**Picture Off**”: Switches off the picture. You can listen to the sound with the picture off.

## RGB Centre

Adjusts the horizontal picture position so that the picture is in the middle of the screen.



This option is only available if an RGB source has been connected to the Scarts connectors

 AV1 or  AV2 on the rear of the TV.

## PC Adjustment

Customizes the TV screen as a PC monitor.



This option is only available if a PC signal is received.

“**Phase**”: Adjusts the screen when a part of a displayed text or image is not clear.

“**Pitch**”: Enlarges or shrinks the screen size horizontally.

“**Horizontal Shift**”: Moves the screen to the left or to the right.

“**Vertical Shift**”: Moves the screen up or down.

“**Power Saving**”: When this is set to “On,” turns to standby mode if no PC signal is received. To return to the TV, press .

“**Reset**”: Resets to the factory settings.

Continued

---

## Timer

Sets the timer to turn off the TV.

### **Sleep Timer**

Sets a period of time after which the TV automatically switches itself into standby mode.

When the “Sleep Timer” is activated, the  (Sleep Timer) indicator on the TV front panel lights up in orange.



- When you turn off the TV and turn it on again, “Sleep Timer” is reset to “Off”.
  - A notification message appears on the screen one minute before the TV switches to standby mode.
-

# Set-up menu

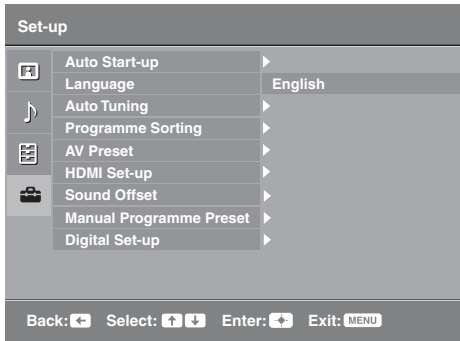

You can select the options listed below on the “Set-up” menu. To select options in “Settings”, see “Navigating through menus” (page 21).

## Auto Start-up

Starts the initial set-up to select the language, country/region and location, and tune in all available digital and analogue channels. Usually, you do not need to do this operation because the language and country/region will have been selected and channels already tuned when the TV was first installed (page 7). However, this option allows you to repeat the process (e.g., to retune the TV after moving house).

## Language

Selects the language in which the menus are displayed.

## Auto Tuning (Only in analogue mode)

Tunes in all the available analogue channels. Usually you do not need to do this operation because the channels are already tuned when the TV was first installed (page 7). However, this option allows you to repeat the process (e.g., to retune the TV after moving house, or to search for new channels that have been launched by broadcasters).

## Programme Sorting (Only in analogue mode)

Changes the order in which the analogue channels are stored on the TV.

- 1 Press  $\uparrow/\downarrow$  to select the channel you want to move to a new position, then press  $\rightarrow$ .
- 2 Press  $\uparrow/\downarrow$  to select the new position for your channel, then press  $\oplus$ .

## AV Preset

Assigns a name to any equipment connected to the side and rear sockets. The name will be displayed briefly on the screen when the equipment is selected. You can skip an input source that is not connected to any equipment.

- 1 Press  $\uparrow/\downarrow$  to select the desired input source, then press  $\oplus$ .
- 2 Press  $\uparrow/\downarrow$  to select the desired option below, then press  $\oplus$ .
  - AV1 (or AV2/AV3/HDMI1/HDMI2/Component/PC), VIDEO, DVD, CABLE, GAME, CAM, SAT: Uses one of the preset labels to assign a name to connected equipment.
  - “Edit”: Creates your own label.

1 Press  $\uparrow/\downarrow$  to select the desired letter or number (“\_” for a blank space), then press  $\rightarrow$ .

### If you input a wrong character

Press  $\leftarrow/\rightarrow$  to select the wrong character. Then, press  $\uparrow/\downarrow$  to select the correct character.

2 Repeat the procedure in step 1 until the name is completed, then press  $\oplus$ .

Continued

---

## HDMI Set-up

Allows the TV to communicate with equipment that is compatible with the control for HDMI function, and connected to the HDMI sockets of the TV. Note that communication settings must also be made on the connected equipment.

**“Control for HDMI”:** Sets whether or not to link the operations of the TV and the connected equipment that is compatible with control for HDMI.

**“Auto Devices Off”:** When this is set to “On”, the connected equipment that is compatible with control for HDMI turns off when you switch the TV to standby mode using the remote.

**“Auto TV On”:** When this is set to “On”, the TV turns on when you turn on the connected equipment that is compatible with control for HDMI.

**“Device List Update”:** Creates or updates the “HDMI Device List”. Up to 11 compatible equipment items can be connected, and up to 5 equipment items can be connected to a single socket. Be sure to update the “HDMI Device List” when you change the connections or settings.

**“HDMI Device List”:** Displays a list of connected equipment that is compatible with control for HDMI.

---

## Sound Offset

Sets an independent volume level to each equipment connected to the TV.

---

## Manual Programme Preset (Only in analogue mode)

Changes the available analogue channel setting.

Press  $\uparrow/\downarrow$  to select the programme number you want to modify. Then, press  $\oplus$ .

### System

Presets programme channels manually.

1 Press  $\uparrow/\downarrow$  to select “System”, then press  $\oplus$ .

2 Press  $\uparrow/\downarrow$  to select one of the following TV broadcast systems, then press  $\leftarrow$ .

B/G: For western European countries/regions

I: For the United Kingdom

D/K: For eastern European countries/regions

L: For France



Depending on the country/region selected for “Country” (page 6), this option may not be available.

### Channel

1 Press  $\uparrow/\downarrow$  to select “Channel”, then press  $\oplus$ .

2 Press  $\uparrow/\downarrow$  to select “S” (for cable channels) or “C” (for terrestrial channels), then press  $\rightarrow$ .

3 Tune the channels as follows:

#### If you do not know the channel number (frequency)

Press  $\uparrow/\downarrow$  to search for the next available channel. When a channel has been found, the search will stop. To continue searching, press  $\uparrow/\downarrow$ .

#### If you know the channel number (frequency)

Press the number buttons to enter the channel number of the broadcast you want or your VCR channel number.

4 Press  $\oplus$  to jump to “Confirm”, then press  $\oplus$ .

Repeat the procedure above to preset other channels manually.

### Label

Assigns a name of your choice, up to five letters or numbers, to the selected channel.

### AFT

Allows you to fine-tune the selected programme number manually if you feel that a slight tuning adjustment will improve the picture quality.

---

---

### **Audio Filter**

Improves the sound for individual channels in the case of distortion in mono broadcasts. Sometimes a non-standard broadcast signal can cause sound distortion or intermittent sound muting when watching mono programmes.

If you do not experience any sound distortion, we recommend that you leave this option set to the factory setting “Off”.



“Audio Filter” is not available when “System” is set to “L”.

### **Skip**

Skips unused analogue channels when you press PROG +/- to select channels. (You can still select a skipped channel using the number buttons.)

### **Confirm**

Saves changes made to the “Manual Programme Preset” settings.

---

# Digital Set-up menu

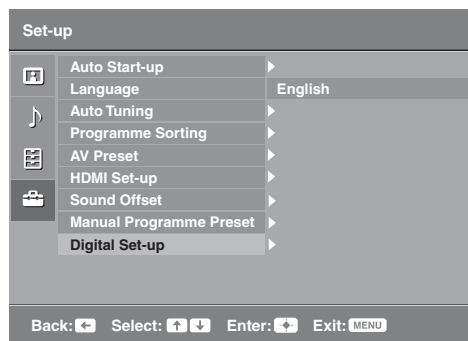

You can select the options listed below on the “Digital Set-up” menu. Then press  $\uparrow/\downarrow$  to select the “Digital Tuning” or “Digital Set-up”. To select options in “Settings”, see “Navigating through menus” (page 21).



Some functions may not be available in some countries/regions.

## Digital Tuning

### Digital Auto Tuning

Tunes in the available digital channels.

This option allows you to retune the TV after moving house, or to search for new channels that have been launched by broadcasters. Press  $\oplus$ .

### Programme List Edit

Removes any unwanted digital channels stored on the TV, and changes the order of the digital channels stored on the TV.

**1** Press  $\uparrow/\downarrow$  to select the channel you want to remove or move to a new position.

Press the number buttons to enter the known three-digit programme number of the broadcast you want.

**2** Remove or change the order of the digital channels as follows:

#### To remove the digital channel

Press  $\oplus$ . After a confirmation message appears, press  $\leftarrow$  to select “Yes”, then press  $\oplus$ .

#### To change the order of the digital channels

Press  $\rightleftarrows$ , then press  $\uparrow/\downarrow$  to select the new position for the channel and press  $\leftarrow$ .

**3** Press RETURN.

### Digital Manual Tuning

Tunes the digital channels manually.

**1** Press the number button to select the channel number you want to manually tune, then press  $\uparrow/\downarrow$  to tune the channel.

**2** When the available channels are found, press  $\oplus$  to store programmes. Repeat the above procedure to manually tune other channels.

## Digital Set-up

### Subtitle Set-up

**“Subtitle Setting”**: When “For Hard Of Hearing” is selected, some visual aids may also be displayed with the subtitles (if TV channels broadcast such information).

**“Subtitle Language”**: Selects which language subtitles are displayed in.

### Audio Set-up

**“Audio Type”**: Switches to broadcast for the hearing impaired when “For Hard Of Hearing” is selected.

**“Audio Language”**: Selects the language used for a programme. Some digital channels may broadcast several audio languages for a programme.

**“Audio Description”**: Provides audio description (narration) of visual information if TV channels broadcast such information.

**“Mixing Level”**: Adjusts the TV main audio and Audio Description output levels.



This option is only available when “Audio Description” is set to “On”.

### Banner Mode

**“Basic”**: Displays programme information with a digital banner.

**“Full”**: Displays programme information with a digital banner, and displays detailed programme information below that banner.

### Parental Lock

Sets an age restriction for programmes. Any programme that exceeds the age restriction can only be watched after a PIN Code is entered correctly.

**1** Press the number buttons to enter your existing PIN code.

If you have not previously set a PIN, a PIN code entry screen appears. Follow the instructions of “PIN Code” below.

**2** Press  $\uparrow/\downarrow$  to select the age restriction or “None” (for unrestricted watching), then press  $\oplus$ .

**3** Press RETURN.

### PIN Code

#### To set your PIN for the first time

**1** Press the number buttons to enter the new PIN code.

**2** Press RETURN.

#### To change your PIN

**1** Press the number buttons to enter your existing PIN code.

**2** Press the number buttons to enter the new PIN code.

**3** Press RETURN.



PIN code 9999 is always accepted.

### Technical Set-up

**“Auto Service Update”**: Enables the TV to detect and store new digital services as they become available.

**“Software Download”**: Enables the TV to automatically receive software updates, free through your existing aerial (when issued). Sony recommends that this option is set to “On” at all times. If you do not want your software to be updated, set this option to “Off”.

**“System Information”**: Displays the current software version and the signal level.

**“Time Zone”**: Allows you to manually select the time zone you are in, if it is not the same as the default time zone setting for your country/region.

**“Auto DST”**: Sets whether or not to automatically switch between summer time and winter time.

- “On”: Automatically switches between summer time and winter time according to the calendar.
- “Off”: The time is displayed according to the time difference set by “Time Zone”.

### CA Module Set-up

Allows you to access a pay TV service once you obtain a Conditional Access Module (CAM) and a view card. See page 18 for the location of the  (PCMCIA) socket.

## Installing the Accessories (Wall-Mount Bracket)

### To Customers:

For product protection and safety reasons, Sony strongly recommends that installing of your TV be performed by Sony dealers or licensed contractors. Do not attempt to install it yourself.

### To Sony Dealers and Contractors:

Provide full attention to safety during the installation, periodic maintenance and examination of this product.

Your TV can be installed using the Wall-Mount Bracket SU-WL500 or SU-WL100 (sold separately).

- Refer to the Instructions supplied with the Wall-Mount Bracket to properly carry out the installation.
- Refer to “Detaching the Table-Top Stand from the TV” (page 7).
- Refer to “TV installation dimensions table” (page 33).
- Refer to “Screw and Hook locations diagram/table” (page 34).



Place the TV on the Table-Top Stand, when securing the Mounting Hook.

### SU-WL500 for KDL-32L40xx

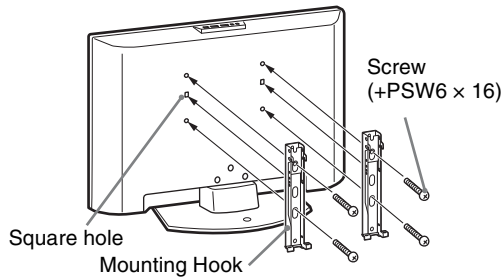

### SU-WL100 for KDL-26L40xx/KDL-19L40xx

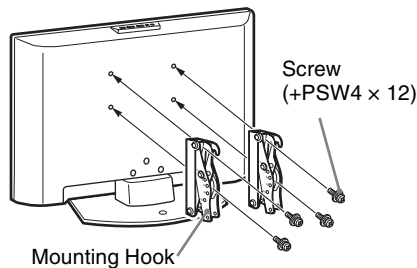

Sufficient expertise is required for installing this product, especially to determine the strength of the wall for withstanding the TV's weight. Be sure to entrust the attachment of this product to the wall to Sony dealers or licensed contractors and pay adequate attention to safety during the installation. Sony is not liable for any damage or injury caused by mishandling or improper installation.



# TV installation dimensions table

## KDL-32L40xx

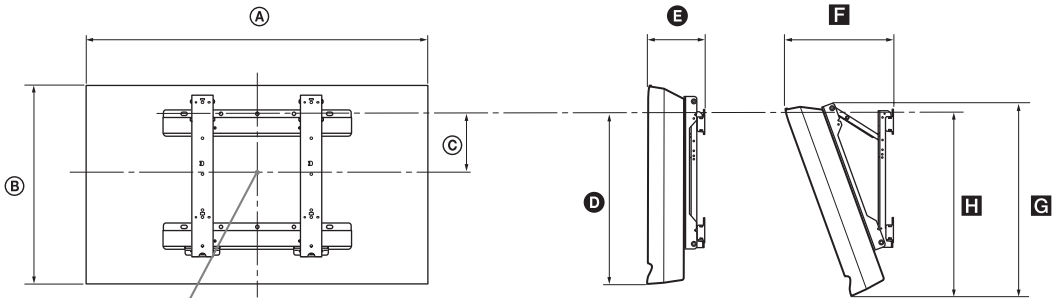

Screen centre point

## KDL-26L40xx

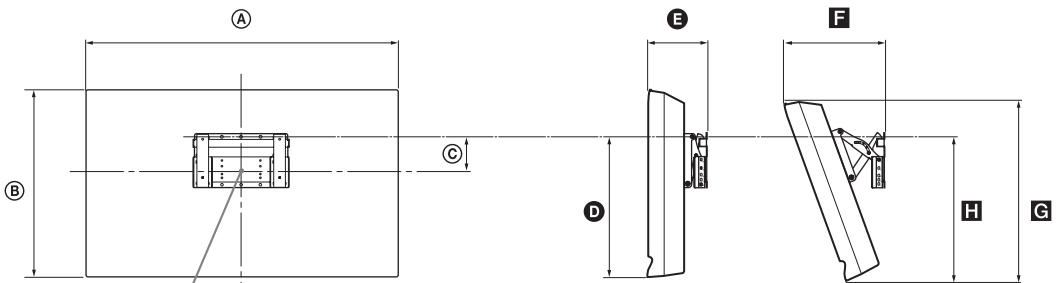

Screen centre point

## KDL-19L40xx

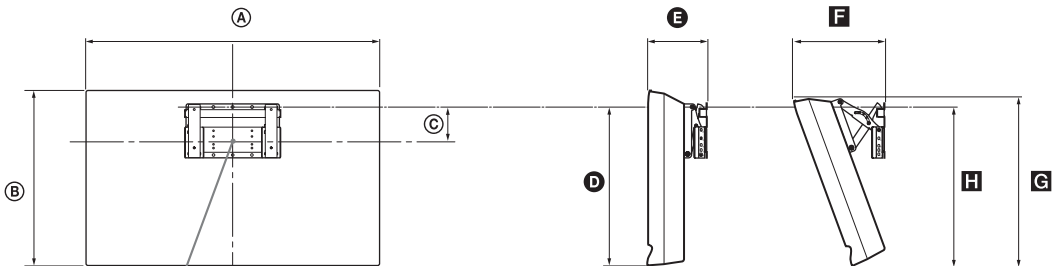

Screen centre point

Unit: mm

Model Name	Display dimensions		Screen centre dimension	Length for each mounting angle				
	A	B		Angle (0°)		Angle (20°)		
			C	D	E	F	G	H
KDL-32L40xx	807	548	172	485	167	304	532	513
KDL-26L40xx	674	470	92	352	153	258	456	357
KDL-19L40xx	479	376	125	339	136	215	362	340

Figures in the above table may differ slightly depending on the installation.

### WARNING

The wall that the TV will be installed on should be capable of supporting a weight of at least four times that of the TV. Refer to "Specifications" (page 35) for its weight.

Continued

# Screw and Hook locations diagram/table

## KDL-32L40xx

Model Name	Screw location	Hook location
KDL-32L40xx	e, g	c

\* Hook position "a" and "b" cannot be used for the model in the table above.

### Screw location

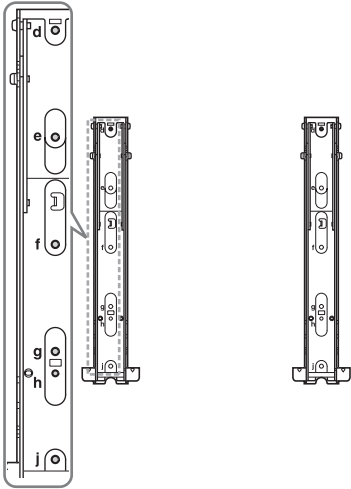

### Hook location

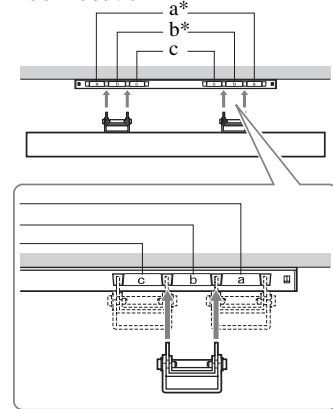





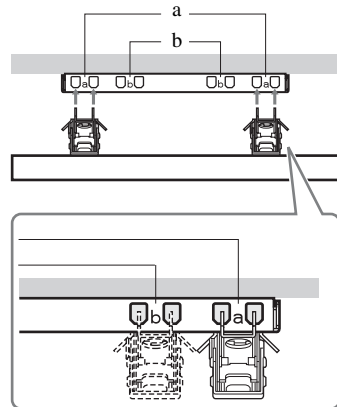



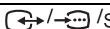
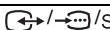

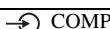
## KDL-26L40xx/KDL-19L40xx

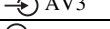
Model Name	Hook location
KDL-26L40xx	a
KDL-19L40xx	b

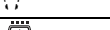

# Specifications

Model name	KDL-32L40xx	KDL-26L40xx	KDL-19L40xx	
<b>System</b>				
Panel System	LCD (Liquid Crystal Display) Panel			
TV System	Depending on your country/region selection Analogue: B/G/H, D/K, L, I Digital: DVB-T			
Colour/Video System	Analogue: PAL, SECAM, NTSC 3.58, 4.43 (only Video In) Digital: MPEG-2 MP@ML			
Channel Coverage	Analogue: 48.25 - 855.25 MHz Digital: VHF Band III (177.5 - 226.5 MHz)/UHF E21 - E69 (474 - 858 MHz)			
Sound Output	10 W + 10 W (RMS)		5 W + 5 W (RMS)	
<b>Input/Output jacks</b>				
Aerial	75 ohm external terminal for VHF/UHF			
 AV1*1	21-pin scart connector including audio/video input, RGB input, S-Video input, and Analog TV audio/video output.			
 AV2*2	21-pin scart connector including audio/video input, RGB input, S-Video input, and audio/video output.			
 COMPONENT IN	Supported formats: 1080i, 720p, 576p, 576i, 480p, 480i Y: 1 Vp-p, 75 ohms, 0.3V negative sync/Pb/Cb: 0.7 Vp-p, 75 ohms/ Pr/Cr: 0.7 Vp-p, 75 ohms			
 COMPONENT IN	Audio input (phono jacks)			
HDMI IN 1, 2	Video: 1080i, 720p, 576p, 576i, 480p, 480i Audio: Two channel linear PCM 32, 44.1 and 48 kHz, 16, 20 and 24 bits PC (see table) Analogue audio (minijack) (HDMI IN 2 only)			
 AV3	Video input (phono jack)			
 AV3	Audio input (phono jacks)			
	Audio output (Left/Right) (phono jacks)			
PC IN 	PC Input (15 Dsub) (see page 36) G: 0.7 Vp-p, 75 ohms, non Sync on Green/B: 0.7 Vp-p, 75 ohms, non Sync on Green/ R: 0.7 Vp-p, 75 ohms, non Sync on Green  PC audio input (minijack)			
	Headphones jack			
	CAM (Conditional Access Module) slot			
<b>Power and others</b>				
Power Requirements	220–240 V AC, 50 Hz			
Screen Size	32 inches (Approx. 81.3 cm measured diagonally)	26 inches (Approx. 66.1 cm measured diagonally)	19 inches (Approx. 48.1 cm measured diagonally)	
Display Resolution	1,366 dots (horizontal) × 768 lines (vertical)		1,680 dots (horizontal) × 1,050 lines (vertical)	
Power Consumption	155 W	98 W	48 W	
Standby Power Consumption*3	0.5 W or less	0.5 W or less	1 W or less	
Dimensions (w × h × d)	(with stand)	Approx. 80.7 × 58.5 × 24.2 cm	Approx. 67.4 × 51.0 × 24.2 cm	Approx. 47.9 × 41.3 × 19.1 cm
	(without stand)	Approx. 80.7 × 54.8 × 10.1 cm	Approx. 67.4 × 47.0 × 9.5 cm	Approx. 47.9 × 37.6 × 7.6 cm
Mass	(with stand)	Approx. 15.0 kg	Approx. 11.7 kg	Approx. 5.8 kg
	(without stand)	Approx. 13.0 kg	Approx. 9.5 kg	Approx. 5.3 kg
Supplied Accessories	Refer to “1: Checking the accessories” on page 4.			
Optional Accessories	See “Installing the Accessories (Wall-Mount Bracket)” on page 32.			

\*1 AV1 outputs available only analogue TV.

\*2 AV2 outputs watching screen (except PC, HDMI1,2, Component 1080i).

\*3 Specified standby power is reached after the TV finishes necessary internal processes.

Design and specifications are subject to change without notice.

### PC Input Signal Reference Chart for PC IN

Signals	Horizontal (Pixel)	Vertical (Line)	Horizontal frequency (kHz)	Vertical frequency (Hz)	Standard
VGA	640	480	31.5	60	VGA
SVGA	800	600	37.9	60	VESA Guidelines
XGA	1024	768	48.4	60	VESA Guidelines
WXGA	1280	768	47.8	60	VESA

- This TV's PC input does not support Sync on Green or Composite Sync.
- This TV's PC input does not support interlaced signals.
- This TV's PC input supports signals in the above chart with a 60 Hz vertical frequency.

### PC Input Signal Reference Chart for HDMI IN 1, 2

Signals	Horizontal (Pixel)	Vertical (Line)	Horizontal frequency (kHz)	Vertical frequency (Hz)	Standard
VGA	640	480	31.5	60	VGA
SVGA	800	600	37.9	60	VESA Guidelines
XGA	1024	768	48.4	60	VESA Guidelines
WXGA	1280	768	47.4	60	VESA
WXGA	1280	768	47.8	60	VESA
WXGA	1360	768	47.7	60	VESA

# Troubleshooting

Check whether the  (standby) indicator is flashing in red.

## When it is flashing



The self-diagnosis function is activated.  
Press  on the top edge of the TV to turn it off, disconnect the mains lead, and inform your dealer or Sony service centre.

## When it is not flashing

- 1 Check the items in the tables below.
- 2 If the problem still persists, have your TV serviced by qualified service personnel.

## Picture

### No picture (screen is dark) and no sound

- Check the aerial connection.
- Connect the TV to the mains, and press  on the top edge of the TV.
- If the  (standby) indicator lights up in red, press .

### No picture or no menu information from equipment connected to the scart connector

- Press  to display the connected equipment list, then select the desired input.
- Check the connection between the optional equipment and the TV.

### Double images or ghosting

- Check the aerial connection.
- Check the aerial location and direction.

### Only snow and noise appear on the screen

- Check if the aerial is broken or bent.
- Check if the aerial has reached the end of its serviceable life (three to five years in normal use, one to two years at the seaside).

### Distorted picture (dotted lines or stripes)

- Keep the TV away from electrical noise sources such as cars, motorcycles, hair-dryers or optical equipment.
- When installing optional equipment, leave some space between the optional equipment and the TV.
- Check the aerial connection.
- Keep the aerial cable away from other connecting cables.

### Picture or sound noise when viewing a TV channel

- Adjust “AFT” (Automatic Fine Tuning) to obtain better picture reception (page 28).

### Some tiny black points and/or bright points appear on the screen

- The picture of a display unit is composed of pixels. Tiny black points and/or bright points (pixels) on the screen do not indicate a malfunction.

### No colour on programmes



- Select “Reset” (page 23).

### No colour or irregular colour when viewing a signal from the COMPONENT IN sockets

- Check the connection of the  COMPONENT IN sockets and check if each sockets are firmly seated in their respective sockets.

## Sound

### No sound, but good picture

- Press  + or  (Mute).
- Check if the “Speaker” is set to “TV Speaker” (page 24).

## Channels

### The desired channel cannot be selected

- Switch between digital and analogue mode and select the desired digital/analogue channel.

### Some channels are blank

- Scrambled/Subscription only channel. Subscribe to the pay TV service.
- Channel is used only for data (no picture or sound).
- Contact the broadcaster for transmission details.

### Digital channels are not displayed

- Contact a local installer to find out if digital transmissions are provided in your area.
- Upgrade to a higher gain aerial.

## General

### The TV turns off automatically (the TV enters standby mode)

- Check if the “Sleep Timer” is activated (page 26).
- If no signal is received and no operation is performed in the TV mode for 15 minutes, the TV automatically switches to standby mode.

### The remote does not function

- Replace the batteries.

### HDMI equipment does not appear on “HDMI Device List”

- Check that your equipment is compatible with control for HDMI.





Instructions on “Installing the Wall-Mount Bracket” are not supplied in the form of a separate leaflet with this TV. These installation instructions are included within this TV’s instructions manual.



For useful information about Sony products

<http://www.sony-europe.com/myproduct/>

<http://www.sony.net/>

Printed in Hungary