

Ordering Information

Family	Distribution	Lamp Type	No. of Lamps	Housing	Module Length	Wiring	Voltage	Ballast	Finish
BSL	6 6 = Direct/ Indirect	H H = T5 HO	02 02 = 2 Light	CN CN = Cutout w/baffles	04 = 4' 08 = 8' 12 = 12'	1 = 1cct. 2 = 2cct. 3 = 1cct. w/EC/NL 4 = 2cct. w/EC/NL 5 = 1cct. w/EM Battery 6 = 2cct. w/EM Battery 7 = 1cct. w/Dimming 8 = 1cct. w/1cct. Thru wire 9 = 2cct. w/1cct. Thru wire Note: Please consult wiring section of spec sheets for more wiring options.	D = Dual 120V & 277V 1 = 120V 2 = 277V	E = Standard <10% THD F = Standard <10% THD w/fusing	C = Custom Color W = Standard White

Specifications

Features

1. Housing: die-formed 20ga. cold rolled steel
2. End Set: die-cast metal with baked powder coat finish
3. Lamping: two T5 HO lamps
4. Configuration: 4', 8' and 12' module lengths or continuous rows
5. Ballasts: electronic 120V or 277V

Finish

High-quality white powder coat with textured matte finish.
Custom colors available. Consult factory.

Mounting

Aircraft cable gripper is tamper-resistant and provides infinite vertical adjustment capability. Aircraft cable, crimp and cable gripper independently tested to meet stringent safety requirements.

Electrical

All luminaires are factory pre-wired to module ends with quick-wire connectors.

Joints & Intersections

Self-aligning joining system with hands-free pre-joining wire access.

Labels

UL, CSA standards.

Ordering Instructions

Individual Fixtures

1. Determine the number of individual modules required
2. Order one end set per module
3. Order one non-power mount per module
4. Order one power mount per module

Continuous Rows*

1. Determine run length
2. Order the appropriate number and length of modules for complete run
3. Order one end set for each run
4. Order one non-power mount for each module
5. Order one power mount per run
6. Order one joiner per module minus one (e.g. 3 modules requires 2 joiners)

***Note:** Some runs may require additional power mounts. Please see the 'Run Configuration' table on the next page for more details.

Job Information

Type:

Job Name:

Cat. No.:

Lamp(s):

Notes:

Lightolier a Genlyte Company

www.lightolier.com

631 Airport Road, Fall River, MA 02720 • (508) 679-8131 • Fax (508) 674-4710

We reserve the right to change details of design, materials and finish.

© 2005 Genlyte Group LLC • 0205 Rev.1

LIGHTOLIER

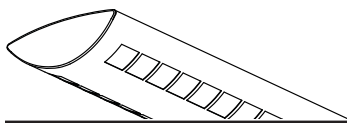

Performance

Candlepower Curve

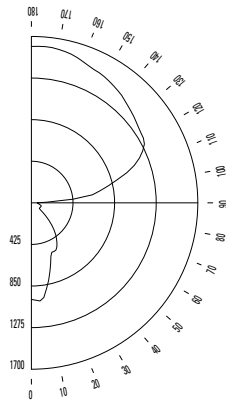

Report No: 2101640
Lamps: F54T5
Lumens per Lamp: 4650
Efficiency: 82.2%
Up: 79.4% **Down:** 20.6%

Candlepower Summary

ZONE DEG.	CANDLEPOWER				
	0	22.5	45	67.5	90
180	1598	1598	1598	1598	1598
175	1590	1592	1596	1601	1602
165	1536	1546	1557	1567	1573
155	1434	1449	1474	1493	1505
145	1286	1306	1365	1439	1461
135	1092	1123	1249	1357	1397
125	865	922	1111	1274	1338
115	613	712	988	1191	1254
105	339	524	804	847	904
95	84	222	379	363	427
90	5	34	48	61	59
85	15	33	56	63	68
75	55	54	77	91	99
65	113	131	82	96	103
55	259	254	190	101	99
45	431	338	355	266	254
35	609	510	469	445	447
25	770	726	593	533	548
15	901	915	857	745	730
5	979	981	998	999	1007
0	987	987	987	987	987

Coefficients of Utilization

	% EFFECTIVE CEILING CAVITY REFLECTANCE								
	80			70			50		
	% WALL REFLECTANCE								
	50	30	10	50	30	10	50	30	10
0	82	82	82	73	73	73	55	55	55
1	72	69	66	63	61	59	48	46	45
2	63	58	54	56	52	48	42	40	37
3	55	50	45	49	44	41	37	34	32
4	49	43	38	44	38	34	33	30	27
5	44	37	33	39	34	30	30	26	23
6	39	33	28	35	30	26	27	23	20
7	35	29	25	31	26	22	24	21	18
8	32	26	22	28	23	20	22	18	16
9	29	23	19	26	21	18	20	17	14
10	26	21	17	24	19	16	19	15	13

Zonal Lumen Summary

ZONE	LUMENS	% BARE LAMP	% LUMINAIRE
0-90	1573	16.9	20.6
90-180	6073	65.3	79.4
0-180	7646	82.2	100.0

Module Lengths & Mounting Distances

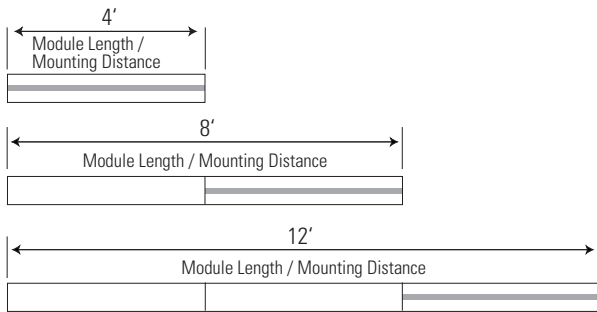

Note: Shaded area indicates locations of emergency sections (emergency wiring controls all lamps or optional battery pack controls one or two lamps).

Run Configuration

Run Length	4' Module	8' Module	12' Module	Joiner	End Set	Mount	Power Mount*
4' run	1				1	1	1
8' run		1			1	1	1
12' run			1		1	1	1
16' run		2		1	1	2	1
20' run		1	1	1	1	2	1
24' run			2	1	1	2	1
28' run		2	1	2	1	3	1
32' run		1	2	2	1	3	1

***Note:** Additional power mounts may be required for some runs with T5 HO lamping options, longer runs, and runs with wiring options that are more complex. Please consult factory for assistance.

System Components & Accessories

End Set

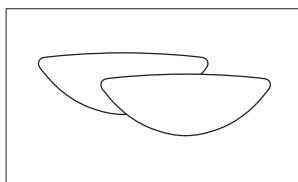

BSLESW = suspended standard white

Joiner

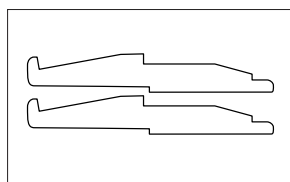

BSLJS = suspended joiner

Job Information

Type:

Lightolier a Genlyte Company www.lightolier.com
 631 Airport Road, Fall River, MA 02720 • (508) 679-8131 • Fax (508) 674-4710
 We reserve the right to change details of design, materials and finish.
 © 2005 Genlyte Group LLC • 0205 Rev.1

LIGHTOLIER®

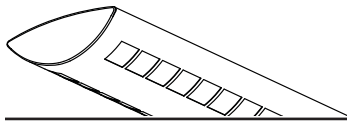

Mounting Options

Mount Type: T-Bar 15/16" (On-Grid)*

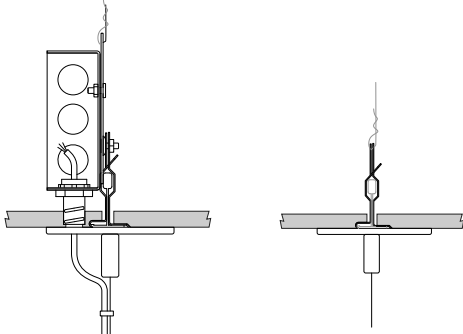

- 65 lbs maximum load
- Canopy: Diameter of 3 3/4" x 7/32"
- Cable: 7x7 stranded aircraft cable
- Supported by T-bar and secured to structure
- J-Box: 4" square (supplied by others)
- Fully adjustable vertically at fixture

1-Power Mount

Non-Power Mount



Supension Length

	2'	4'	8'	12'
1-Power Mount				
3 Conductor	BSLM6102P13	BSLM6104P13	BSLM6108P13	BSLM6112P13
4 Conductor	BSLM6102P14	BSLM6104P14	BSLM6108P14	BSLM6112P14
7 Conductor	BSLM6102P17	BSLM6104P17	BSLM6108P17	BSLM6112P17
Non-Power Mount	BSLM6102N	BSLM6104N	BSLM6108N	BSLM6112N

Mount Type: T-Bar 9/16" (On-Grid)*

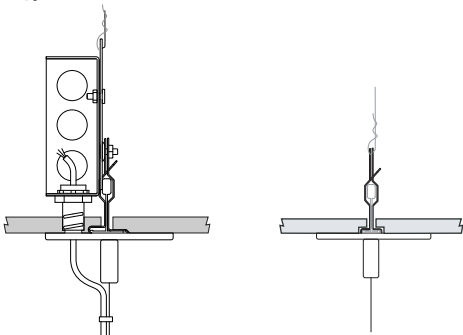

- 65 lbs maximum load
- Canopy: Diameter of 3 3/4" x 7/32"
- Cable: 7x7 stranded aircraft cable
- Supported by T-bar and secured to structure
- J-Box: 4" square (supplied by others)
- Fully adjustable vertically at fixture

1-Power Mount

Non-Power Mount



Supension Length

	2'	4'	8'	12'
1-Power Mount				
3 Conductor	BSLM6202P13	BSLM6204P13	BSLM6208P13	BSLM6212P13
4 Conductor	BSLM6202P14	BSLM6204P14	BSLM6208P14	BSLM6212P14
7 Conductor	BSLM6202P17	BSLM6204P17	BSLM6208P17	BSLM6212P17
Non-Power Mount	BSLM6202N	BSLM6204N	BSLM6208N	BSLM6212N

Mount Type: T-Bar 9/16" by 5/16" Slot Grid (On-Grid)*

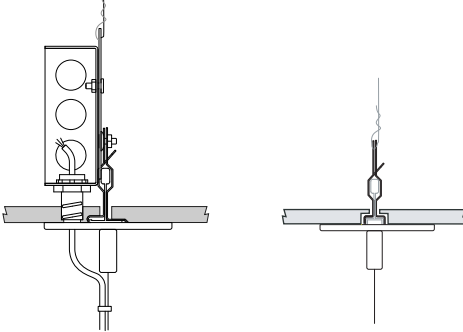

- 65 lbs maximum load
- Canopy: Diameter of 3 3/4" x 7/32"
- Cable: 7x7 stranded aircraft cable
- Supported by T-bar and secured to structure
- J-Box: 4" square (supplied by others)
- Fully adjustable vertically at fixture

1-Power Mount

Non-Power Mount



Supension Length

	2'	4'	8'	12'
1-Power Mount				
3 Conductor	BSLM6302P13	BSLM6304P13	BSLM6308P13	BSLM6312P13
4 Conductor	BSLM6302P14	BSLM6304P14	BSLM6308P14	BSLM6312P14
7 Conductor	BSLM6302P17	BSLM6304P17	BSLM6308P17	BSLM6312P17
Non-Power Mount	BSLM6302N	BSLM6304N	BSLM6308N	BSLM6312N

*Note: Standard T-bar mounts are currently not available for tegular tile ceilings, however certain tegular tile / T-bar combinations may be supported by the use of the slot-grid mount. For more information, please consult factory.

Job Information

Type:

Lightolier a Genlyte Company www.lightolier.com
 631 Airport Road, Fall River, MA 02720 • (508) 679-8131 • Fax (508) 674-4710
 We reserve the right to change details of design, materials and finish.
 © 2005 Genlyte Group LLC • 0205 Rev.1

LIGHTOLIER

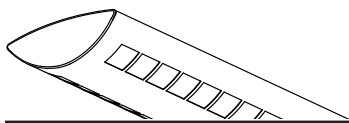

Lighting Systems **Baselyte-BSL5**

Mount Type: T-Bar Fixed Position (1/4-20 Threaded Rod)

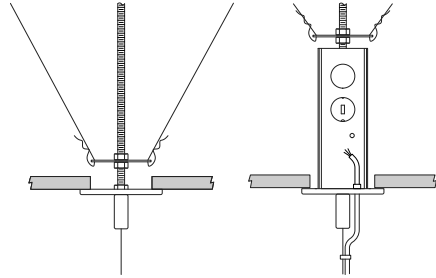

- Meets UBC, OSHPD and DSA seismic requirements
- Canopy: Diameter of 5 1/4" x 3/4" (power)
- Cable: 7x7 stranded aircraft cable
- Tile cut-out hole: Diameter of 2 1/2" (power) or 3/4" (non-power)
- J-Box: Integral J-Box supplied
- 1/4 - 20 all thread rod (supplied by others)
- Fully vertically adjustable at fixture



Supension Length

	2'	4'	8'	12'
1-Power Mount				
3 Conductor	BSLM2102P13	BSLM2104P13	BSLM2108P13	BSLM2112P13
4 Conductor	BSLM2102P14	BSLM2104P14	BSLM2108P14	BSLM2112P14
2-Power Mount				
3 Conductor	BSLM2102P23	BSLM2104P23	BSLM2108P23	BSLM2112P23
Non-Power Mount	BSLM2102N	BSLM2104N	BSLM2108N	BSLM2112N

Mount Type: T-Bar Variable Position

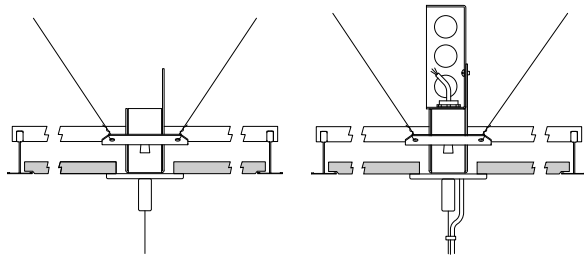

- Meets UBC, OSHPD and DSA seismic requirements
- Canopy: Diameter of 3" x 7/32"
- Cable: 7x7 stranded aircraft cable
- Tile cut-out hole: Diameter of 2 1/4"
- Aligned by T-bar and secured to structure
- J-Box 4" square (supplied by others)
- Fully vertically adjustable at fixture
- Adjusts to both 1" and 1 1/2" high T-bar systems



Supension Length

	2'	4'	8'	12'
1-Power Mount				
3 Conductor	BSLM5102P13	BSLM5104P13	BSLM5108P13	BSLM5112P13
4 Conductor	BSLM5102P14	BSLM5104P14	BSLM5108P14	BSLM5112P14
7 Conductor	BSLM5102P17	BSLM5104P17	BSLM5108P17	BSLM5112P17
2-Power Mount				
3 Conductor	BSLM5102P23	BSLM5104P23	BSLM5108P23	BSLM5112P23
Non-Power Mount	BSLM5102N	BSLM5104N	BSLM5108N	BSLM5112N

***Note:** Supports 15/16", 9/16" and slot grid ceiling types.

Mount Type: Support or Open-Joist Ceiling

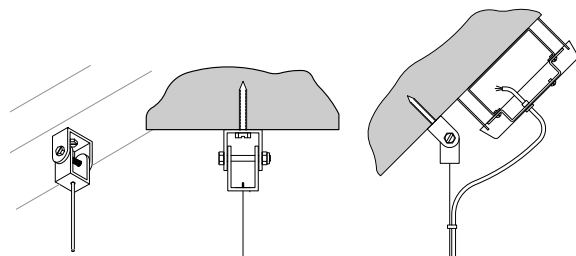

- Meets UBC, OSHPD and DSA seismic requirements
- Canopy: Diameter of 5 1/4" x 3/4" (power)
- Cable: 7x7 stranded aircraft cable
- Versatile mount, fully adjustable to accomodate open sloped ceilings
- J-Box: 4" octogonal box (supplied by others)
- Fully vertically adjustable at fixture



Supension Length

	2'	4'	8'	12'
1-Power Mount				
3 Conductor	BSLM3102P13	BSLM3104P13	BSLM3108P13	BSLM3112P13
4 Conductor	BSLM3102P14	BSLM3104P14	BSLM3108P14	BSLM3112P14
7 Conductor	BSLM3102P17	BSLM3104P17	BSLM3108P17	BSLM3112P17
2-Power Mount				
3 Conductor	BSLM3102P23	BSLM3104P23	BSLM3108P23	BSLM3112P23
Non-Power Mount	BSLM3102N	BSLM3104N	BSLM3108N	BSLM3112N

Job Information **Type:**

Lightolier a Genlyte Company www.lightolier.com
 631 Airport Road, Fall River, MA 02720 • (508) 679-8131 • Fax (508) 674-4710
 We reserve the right to change details of design, materials and finish.
 © 2005 Genlyte Group LLC • 0205 Rev.1

LIGHTOLIER

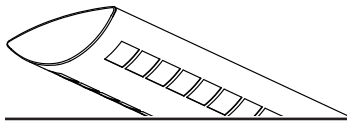

Mount Type: Non-Accessible Ceilings (concrete, gypsum etc.)

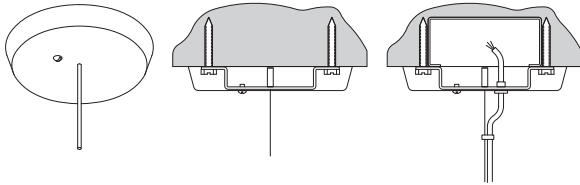

- Meets UBC, OSHPD and DSA seismic requirements
- Canopy: Diameter of 5 1/4" x 3/4" (power)
- Cable: 7x7 stranded aircraft cable
- Mountable on 0° - 15° sloped ceiling
- Optional Chicago Plenum approved version available (A4)
- J-Box: 4" octagonal box (supplied by others)
- Fully vertically adjustable at fixture



Suspension Length

	2'	4'	8'	12'
1-Power Mount				
3 Conductor	BSLM1102P13	BSLM1104P13	BSLM1108P13	BSLM1112P13
4 Conductor	BSLM1102P14	BSLM1104P14	BSLM1108P14	BSLM1112P14
7 Conductor	BSLM1102P17	BSLM1104P17	BSLM1108P17	BSLM1112P17
2-Power Mount				
3 Conductor	BSLM1102P23	BSLM1104P23	BSLM1108P23	BSLM1112P23
Non-Power Mount	BSLM1102N	BSLM1104N	BSLM1108N	BSLM1112N

Cord Types

3 Conductor

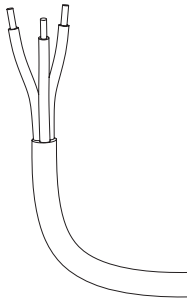

- Max. 10 amps
- Max. 300V

4 Conductor

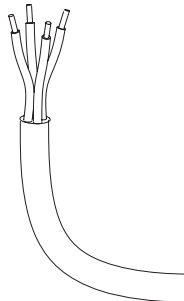

- Max. 10 amps in a 1 circuit application
- Max. 5 amps per circuit in a 2 circuit application
- Max. 300V
- Good for 2 circuit feeds or a 1 circuit feed with a battery pack hot lead
- 120V or 277V applications

7 Conductor

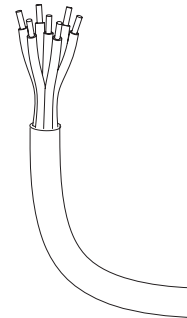

- Max. 10 amps in a 1 circuit application
- Max. 5 amps per circuit in a multi-circuit application
- Good for 3 circuit feeds or 2 circuit feeds with a battery pack hot lead
- 120V or 277V applications

Job Information

Type:

Lightolier a Genlyte Company www.lightolier.com
 631 Airport Road, Fall River, MA 02720 • (508) 679-8131 • Fax (508) 674-4710
 We reserve the right to change details of design, materials and finish.
 © 2005 Genlyte Group LLC • 0205 Rev.1

LIGHTOLIER®

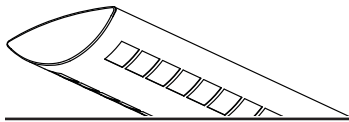

Wiring Options: 1 Circuit

1 Circuit

- Type 1:** 1cct.
- Type 8:** 1cct. w/1cct. thru wire
- Type H:** 1cct. w/2cct. thru wire
- Type 7:** 1cct. w/dimming



All lamps wired on one circuit.

1 Circuit with Emergency Circuit/Night Light (EC/NL)

- Type 3:** 1cct. w/EC/NL

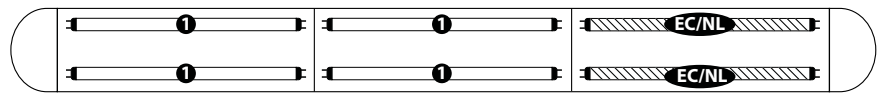

One 4' section in a one circuit fixture to be wired on a separate thru circuit. Leads for both normal circuit and EC/NL circuit wired to fixture ends. All lamps in EC/NL section to be wired together.

1 Circuit with Emergency Battery Pack (EM)

- Type 5:** Chloride standard CTP700
- Type M:** Bodine standard LP550
- Type E:** Chloride high performance CTP1300
- Type P:** Bodine high performance LP600

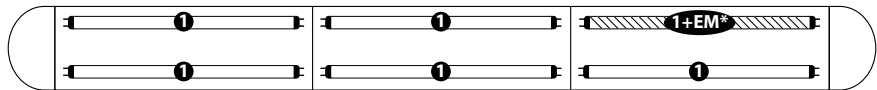

All lamps wired on one circuit, plus a battery pack is wired to one lamp. A hot lead is connected to the battery pack and would function as a 'trigger' wire when connected to a constant hot by installer. Leads for both normal circuit and battery pack are wired to fixture ends.

**Note: Multi-lamp battery packs are also available.*

1 Circuit with Emergency Circuit/Night Light and Emergency Battery Pack

- Type J:** Chloride standard CTP700

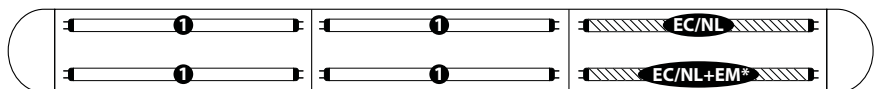

One 4' section in a one circuit fixture to be wired on a separate thru circuit, in addition, a battery pack is wired to one lamp. Installer can connect 'trigger' wire to EC hot lead if controlled together or wire separately if controlled independently. Leads for normal circuit and EM wired to fixture ends. All lamps in EC/NL section to be wired together.

**Note: Multi-lamp battery packs are also available.*

Job Information

Type:

Lightolier a Genlyte Company www.lightolier.com
 631 Airport Road, Fall River, MA 02720 • (508) 679-8131 • Fax (508) 674-4710
 We reserve the right to change details of design, materials and finish.
 © 2005 Genlyte Group LLC • 0205 Rev.1

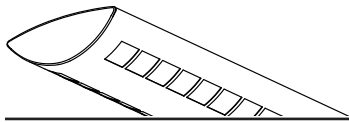

Wiring Options: 2 Circuit Left/Right Switching

2 Circuit Left/Right Switching

- Type 2:** 2cct.
- Type 9:** 2cct. w/1cct. thru wire
- Type I:** 2cct. w/2cct. thru wire

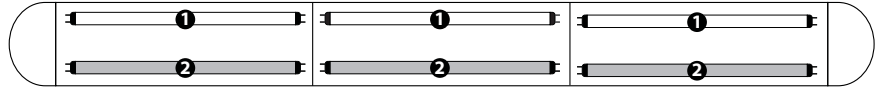

Fixture wired for two circuit. Lamps wired for left/right switching.

2 Circuit Left/Right Switching with Emergency Circuit/Night Light (EC/NL)

- Type 4:** 2cct. w/EC/NL

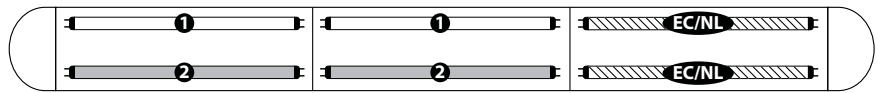

One 4' section in two circuit fixture (left/right switching) to be wired on a separate thru circuit. Leads for both normal circuit and EC/NL circuit wired to fixture ends. All lamps in EC/NL section to be wired together.

2 Circuit Left/Right Switching with Emergency Battery Pack (EM)

- Type 6:** Chloride standard
CTP700
- Type N:** Bodine standard
LP550
- Type F:** Chloride high performance
CTP1300
- Type Q:** Bodine high performance
LP600

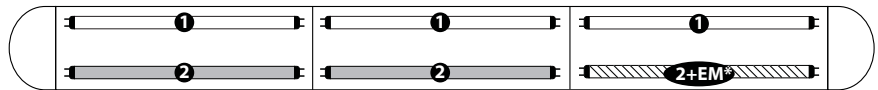

Fixture wired for two circuits (left/right switching), plus a battery pack is wired to one lamp. A hot lead is connected to the battery pack and would act as a 'trigger' wire when connected to a constant hot by installer. Leads for both normal circuit and battery pack are wired to fixture ends.

**Note: Multi-lamp battery packs are also available.*

2 Circuit Left/Right Switching with Emergency Circuit/Night Light and Emergency Battery Pack

- Type K:** Chloride standard
CTP700

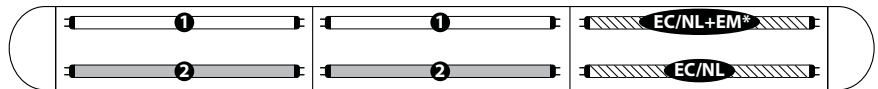

One 4' section in a two circuit fixture (left/right switching) to be wired on a separate thru circuit, in addition, a battery pack is wired to one lamp. Installer can connect 'trigger' wire to EC hot lead if controlled together or wired separately if controlled independently. Leads for both normal circuit, EC/NL and battery pack are wired to fixture ends. All lamps in EC/NL section to be wired together.

**Note: Multi-lamp battery packs are also available.*

Job Information

Type:

Lightolier a Genlyte Company www.lightolier.com
 631 Airport Road, Fall River, MA 02720 • (508) 679-8131 • Fax (508) 674-4710
 We reserve the right to change details of design, materials and finish.
 © 2005 Genlyte Group LLC • 0205 Rev.1

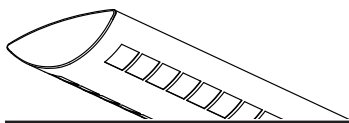

Wiring Options: 2 Circuit A/B Switching (alternate 4' sections)

2 Circuit A/B Switching (alternate 4' sections)

- Type B:** 2cct. A/B
- Type A:** 2cct. A/B w/1cct. thru wire
- Type S:** 2cct. A/B w/2cct. thru wire

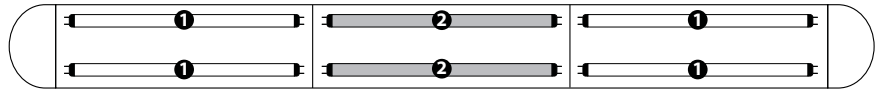

Fixture wired for two circuit. Lamps wired for A/B switching in alternate 4' sections.

2 Circuit A/B Switching (alternate 4' sections) with Emergency Circuit/Night Light (EC/NL)

- Type C:** 2cct. w/EC/NL

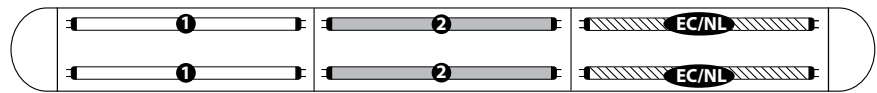

One 4' section in a two circuit fixture (A/B switching) to be wired on a separate thru circuit. Leads for both normal circuit and EC/NL circuit wired to fixture ends. All lamps in EC/NL section to be wired together.

2 Circuit A/B Switching (alternate 4' sections) with Emergency Battery Pack (EM)

- Type D:** Chloride standard
CTP700
- Type O:** Bodine standard
LP550
- Type G:** Chloride high performance
CTP1300
- Type R:** Bodine high performance
LP600

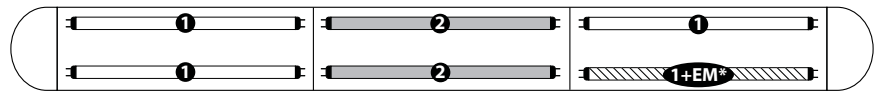

Fixture wired for two circuits (A/B switching), plus a battery pack is wired to one lamp. A hot lead is connected to the battery pack and would act as a 'trigger' wire when connected to a constant hot by installer. Leads for both normal circuit and battery pack are wired to fixture ends.

**Note: Multi-lamp battery packs are also available.*

2 Circuit A/B Switching (alternate 4' sections) with Emergency Circuit/Night Light and Emergency Battery Pack

- Type L:** Chloride standard
CTP700

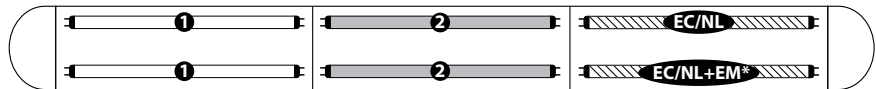

One 4' section in a two circuit fixture (A/B switching) to be wired on a separate thru circuit, in addition, a battery pack is wired to one lamp. Installer can connect 'trigger' wire to EC hot lead if controlled together or wired separately if controlled independently. Leads for normal circuit, EC/NL circuit and battery pack are wired to fixture ends. All lamps in EC/NL section to be wired together.

**Note: Multi-lamp battery packs are also available.*

Job Information

Type:

Lightolier a Genlyte Company www.lightolier.com
 631 Airport Road, Fall River, MA 02720 • (508) 679-8131 • Fax (508) 674-4710
 We reserve the right to change details of design, materials and finish.
 © 2005 Genlyte Group LLC • 0205 Rev.1

LIGHTOLIER®