

Feature Specifications – Energos Control System (For standard Energos fixtures consult appropriate EG spec sheets)

Feature Specifications

Electrical

Dedicated low voltage (24 VDC) circuit controls the Energos Control Systems. The line voltage circuits control all the standard ballast functions including A/B switching, Dimming and Emergency Battery Pack operations.



1. End Cap Sensor Mounting

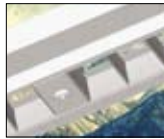

2. Mid-mounted 8' (243.84cm) Sensor Mounting

ECS occupancy sensors are available in two variations:

- Mounted in the end cap.
- The middle of an 8' (243.84cm) module.

The ECS system control-center is the Power Pack. The Power Pack, contained in each Master Module, interrupts the circuits when parameters dictate. The Power Pack can control up to 600 watts 120 VAC, and 1300 watts 277 VAC. A maximum of 10 sensors can be used on a single Power Pack. There is no limitation to the number of Power Packs that can be "daisy-chained" to a single ECS circuit.

Emergency battery packs can be used in conjunction with ECS for emergency egress lighting since all listed packs operate for a minimum of 90 minutes. EM Packs can be used as momentary lighting for emergency circuit for power transitions, and smaller packs are recommended for this purpose.

Dimming ballasts can be used in conjunction with ECS. However, the control system will only perform ON or OFF operations and will not affect the level of dimming set by the dimming ballasts.

Factory installed ballast disconnect allows the ballast to be disconnected from and reconnected to incoming power under load without turning the entire circuit off.

Serial Row Linking (SRL) provides multiple continuous row communication. For every run that SRL is required, order the appropriate SRL end set from page 2 of this Specification Sheet. Consult Energos Application Guide for more detailed definitions and examples.

Mountings

Cable suspension distances are on 48" (121.92cm) and 96" (243.84cm) centers, and consist of a 4 1/2" (11.43cm) diameter canopy finished white enamel. A 1/16" (0.16cm) diameter stainless steel aircraft cable accomplishes suspension and is adjustable from 12" (30.48cm) to 36" (91.44cm). Power feeds are 18 gauge silver braided cord with clear jacket.

Occupancy Sensors:

- Time delay is factory pre-set to 30 minutes.
- Time delay can be field adjusted from 30 minutes to a minimum of 30 seconds.
- Daylight hold-off is factory pre-set to 120 ft-candles (1291.67m-candles).
- Daylight hold-off is field adjustable from 120 ft-candles (1291.67m-candles) down to 10 ft-candles (107.64m-candles).
- Sensors are designed for a detection area (sensitivity diameter) of 16' (487.68cm) when suspended 10' (304.80cm) AFF. Lowering the sensor produces a smaller area of detection. See chart and diagram for additional information.

Coverage Diameter

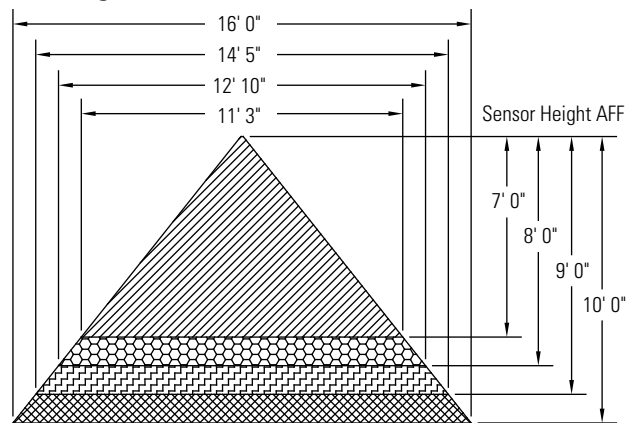

Energos Occupancy Sensor Coverage Zone Chart

Height of Sensor	Broadcast Diameter	Task Diameter
10' 0" (304.80cm)	16' 0" (487.68cm)	8' 0" (243.84cm)
9' 0" (274.32cm)	14' 5" (427.99cm)	7' 3" (214.12cm)
8' 0" (243.84cm)	12' 10" (391.16cm)	6' 5" (184.15cm)
7' 0" (213.36cm)	11' 3" (336.04cm)	5' 7" (154.18cm)

Job Information	Type:
Job Name:	
Cat. No.:	
Lamp(s):	
Notes:	

631 Airport Road, Fall River, MA 02720 • (508) 679-8131 • Fax (508) 674-4710
 We reserve the right to change details of design, materials and finish.
 www.lightolier.com © 2008 Philips Group • C0808

Control Ordering Information

Family	Series	Lamping & Distribution	Ballast	Lamp	Shielding	Length	Voltage	Finish	Options (Blank)
EC	2	3 = 3 lamp, open top 6 = 3 lamp, slotted top reflector	See Chart on Page 3	See Chart on Page 3	P = Parabolic Louver	4 = 4' (121.92cm) 8 = 8' (243.84cm)	6 = 120 Vac Master 7 = 277 Vac Master 8 = 120 Vac Slave 9 = 277 Vac Slave	A = Aluminum W = White	4 = 4 through wires 5 = 5 through wires 6 = 6 through wires D = Dual Switch T = Tandem Switch E = Emergency

Ordering Instructions

End Cap ECS Systems

- Order Master 4' (121.92cm) or 8' (243.84cm) ECS Module.
- Order Power Feed End Set.

Continuous Row Mounted ECS Systems:

- Determine run length
- Order a minimum of one master per run. Please see Application Guide for master requirements on runs that exceed 16' (487.68cm).
- Order the required remaining Master and Slave modules to complete the run.
- Order Power Feed End Set.
- Order one CABLE ASSEMBLY per MODULE minus one per run.
- Order additional Single Cable & Cord Sets for every Master Module in run.

ECS Sensor Sample Runs



4' Run: 4' (121.92cm) Master Module with Single Sensor End Set.



8' Run: 8' (243.84cm) Master Module and standard Energos End Set.



8' Run: 8' (243.84cm) Master Module and Dual Sensor End Set.



12' Run: 8' (243.84cm) Master Module, 4' (121.92cm) Slave Module, Dual Sensor End Set, and Intermediate Cable Assembly.

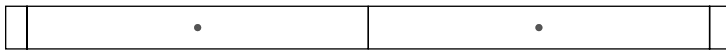

16' Run: 8' (243.84cm) Master Module, 8' (243.84cm) Slave Module, standard Energos End Set, and Intermediate Cable Assembly.

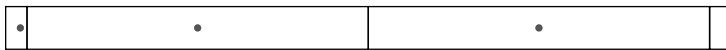

16' Run: 8' (243.84cm) Master Module, 8' (243.84cm) Slave Module, Single Sensor End Set, and Intermediate Cable Assembly.

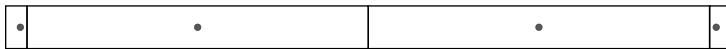

16' Run: 8' (243.84cm) Master Module, 8' (243.84cm) Slave Module, Single Sensor End Set, and Intermediate Cable Assembly.

Notes:

- See page 1 of Specification Sheet or consult Application Guide for the definition of Serial Row Linking (SRL).
- Consult the matching EG specification sheet for Luminaire related specifications (i.e. Housing materials, shielding, mounting dimensions, and photometry).

ECS End Sets

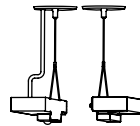

Single Sensor End Set EC2SE36W

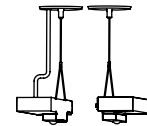

Dual Sensor End Set EC2DE36W



Single Cable & Power Cord EGCC36

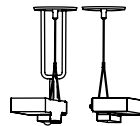

Single Sensor SRL End Set EC2SR36W

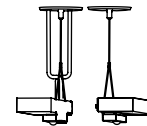

Dual Sensor SRL End Set EC2DR36W

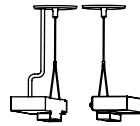

Standard End Set EG2EC36W

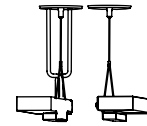

SRL Standard End Set EC2ER36W

Job Information

Type:

631 Airport Road, Fall River, MA 02720 • (508) 679-8131 • Fax (508) 674-4710
 We reserve the right to change details of design, materials and finish.
 www.lightolier.com © 2008 Philips Group • C0808

Ballast Ordering Information

Design	Lamp Type	Ballast Factor	Start Type	THD %
F	T5	1.00	Program	<10
G	T5HO	1.00	Program	<10
I	Dim T5	1.00 / .01	Program	<10
J	Dim T5HO	1.00 / .03	Program	<10

Lamp Ordering Information

Design	Lamp Type	Wattage	Rated Output (Lumens)	Color (K)
M	T5	28	2600*	3000
N	T5	28	2600*	3500
O	T5	28	2600*	4100
P	T5	54	4450*	3000
Q	T5	54	4450*	3500
R	T5	54	4450*	4100

*25°C Rating

Lamp and Ballast System Data

Design	Lamp Type (T8 or T5)	Ballast Factor (BF)	Ballast THD (%)	Lamp Rated Wattage	Lamp Rated Output	Lamp Color (Kelvin)	IES Output (lumens)	System Input Watts	System Efficacy (lum/watt)	System Lamp Life (Hours)	Start Type
FM	T5	1	<10	28	2600	3000	2600	31.0	83.87	20000	Program
FN	T5	1	<10	28	2600	3500	2600	31.0	83.87	20000	Program
FO	T5	1	<10	28	2600	4100	2600	31.0	83.87	20000	Program
GP	HO	1	<10	54	4450	3000	4450	58.5	76.07	20000	Program
GQ	HO	1	<10	54	4450	3500	4450	58.5	76.07	20000	Program
GR	HO	1	<10	54	4450	4100	4450	58.5	76.07	20000	Program
IM	T5 DIM	1.0 / .01	<10	28	2600	3000	2600 / 26	33.5 / 8	77.60	NA	Program
IN	T5 DIM	1.0 / .01	<10	28	2600	3500	2600 / 26	33.5 / 8	77.60	NA	Program
IO	T5 DIM	1.0 / .01	<10	28	2600	4100	2600 / 26	33.5 / 8	77.60	NA	Program
JP	T5HO DIM	1.0 / .03	<10	54	4450	3000	4450 / 134	63 / 12.5	70.60	NA	Program
JQ	T5HO DIM	1.0 / .03	<10	54	4450	3500	4450 / 134	63 / 12.5	70.60	NA	Program
JR	T5HO DIM	1.0 / .03	<10	54	4450	4100	4450 / 134	63 / 12.5	70.60	NA	Program

*25°C Rating

All data is per 1 lamp on a two lamp system at 277 VAC.

Data is based on Osram Sylvania specifications.

When ordering no lamps provided by Lightolier, use lamp code "Z".

Do not alter lumen values or ballast factor light losses when completing calculations using Energos IES files. Files have already been adjusted. The lumen value for the lamp (within a Lighting Design program) will be the IES Output value shown on this table.

Job Information

Type:

631 Airport Road, Fall River, MA 02720 • (508) 679-8131 • Fax (508) 674-4710

We reserve the right to change details of design, materials and finish.

www.lightolier.com © 2008 Philips Group • C0808