

# Coffaire Drop Basket Recessed Fluorescent **CDS2GPF228 or 254**

## Features

- Direct/indirect lamp shield appearance with soft contoured interior.
- Perforated mesh lamp shield with white acrylic overlay.
- 69.9% efficient (2 lamp 28W T5).
- 66.4% efficient (2 lamp 54W T5HO).
- Only 2-1/4" plenum depth.
- Same fixture fits both G and T ceiling types.
- Fits flush to face of slot grid (T) ceiling.
- Lamp shield hinges from either side.
- Wiring access plate standard.
- Optional DALI ballast iGEN TECHNOLOGY accepts digital dimming controllers, scene controllers and automatic control devices.
- Construction to meet Chicago Plenum available.
- Meets NYC Code requirements.
- Not for continuous row mounting.

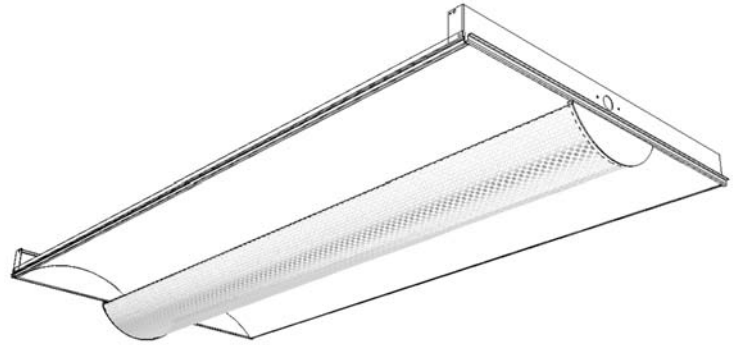

## Mounting Methods

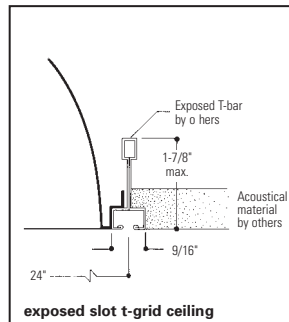
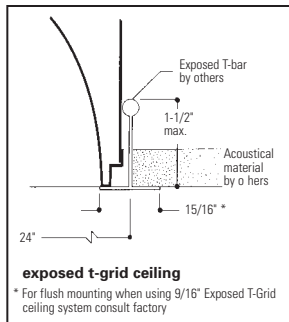

## Features

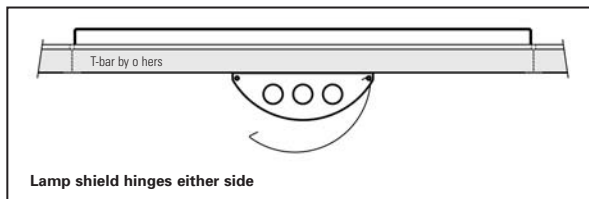
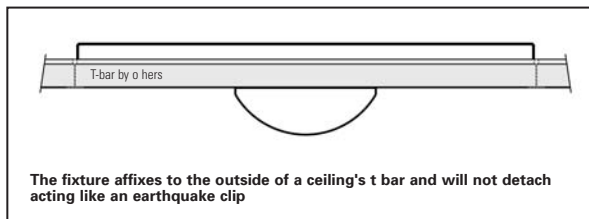

## Dimensions

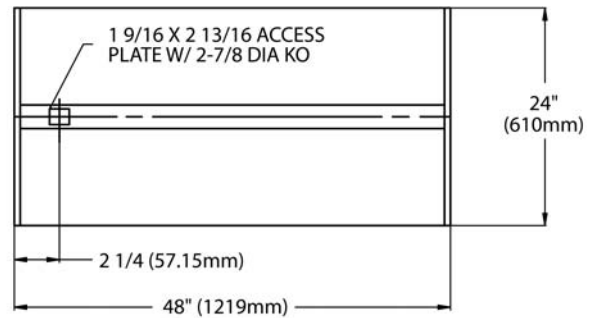
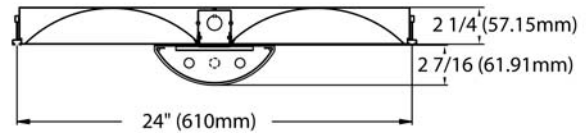

## Job Information

Type:

Job Name:

Cat. No.:

Lamp(s):

Volts/Ballast:

Lightolier a Genlyte company www.lightolier.com  
 Technical Information: (978) 657-7600 • Fax (978) 658-0595  
 631 Airport Road, Fall River, MA 02720 • (508) 679-8131 • Fax (508) 674-4710  
 We reserve the right to change details of design, materials and finish.  
 © 2007 a Genlyte company Section 5/Folio M15-82

# Coffaire Drop Basket Recessed Fluorescent **CDS2GPF228 or 254**

## Model No. CDS2GPF228UNVPG

LER = FP - 33.2 IW - 122.1 BF - 1.0  
Comparative yearly lighting ene gy cost per  
1000 lumens = \$7.29

Report Number: G2007118  
Catalog Number: CDS2GPF228UNVPG  
Lamps: (2) F28T5  
Luminaire: Coffaire Drop Basket  
Ballast: B228PUNV-D  
Report is based on 2900 Lumens per lamp.  
Efficiency: 69.9%  
CIE Type-Direct-Indirect  
Plane: 0-Deg 90-Deg  
Spacing Criteria: 1.2 1.3  
Shielding Angles: 90 90  
Plane: 0-Deg 90-Deg  
Luminous Length: 47.880 23.400

### CANDELA DISTRIBUTION

	0.0	45.0	90.0	FLUX
0	1225	1225	1225	
5	1217	1219	1222	116
15	1159	1174	1190	332
25	1055	1093	1134	504
35	907	982	1055	615
45	728	854	956	655
55	526	717	850	630
65	326	588	728	554
75	163	447	563	431
85	39	219	309	220
90	5	71	142	

### COEFFICIENTS OF UTILIZATION – ZONAL CAVITY METHOD, EFFECTIVE FLOOR CAVITY REFLECTANCE 0.20

RC	80	50	30	10
1	75	71	67	66
2	67	61	55	57
3	61	53	46	49
4	55	46	44	44
5	51	41	34	39
6	47	37	30	35
7	43	33	27	32
8	40	30	24	29
9	38	28	22	27
10	35	26	20	25

### ZONAL LUMEN SUMMARY

ZONE	LUMENS	% LAMP	% FIXT
0- 30	952	16.4	23.5
0- 40	1567	27.0	38.6
0- 60	2852	49.2	70.3
0- 90	4057	69.9	100.0
90-180	0	0.0	0.0
0-180	4057	69.9	100.0

### LUMINANCE DATA IN CANDELA/SQ. METER

AVERAGE IN DEG.	AVERAGE 0-DEG.	AVERAGE 45-DEG.	AVERAGE 90-DEG.
45	956.	958.	935.
55	747.	838.	844.
65	521.	741.	758.
75	308.	623.	636.
85	94.	365.	394.

## Model No. CDS2GPF254UNVPG

LER = FP - 54.6 IW - 121.6 BF - 1.0  
Comparative yearly lighting ene gy cost per  
1000 lumens = \$4.40

Report Number: G2007117  
Catalog Number: CDS2GPF254UNVPG  
Lamps: (2) F54T5HO  
Luminaire: Coffaire Drop Basket  
Ballast: B254PUNV-D (Universal)  
Report is based on 5000 Lumens per lamp.  
Efficiency: 66.4%  
CIE Type-Direct-Indirect  
Plane: 0-Deg 90-Deg  
Spacing Criteria: 1.2 1.3  
Shielding Angles: 90 90  
Plane: 0-Deg 90-Deg  
Luminous Length: 47.880 23.400

### CANDELA DISTRIBUTION

	0.0	45.0	90.0	FLUX
0	2020	2020	2020	
5	2007	2008	2012	191
15	1913	1934	1960	547
25	1737	1799	1865	830
35	1494	1616	1735	1011
45	1196	1402	1572	1076
55	860	1176	1394	1033
65	532	960	1188	905
75	264	724	903	698
85	60	349	490	348
90	7	113	222	

### COEFFICIENTS OF UTILIZATION – ZONAL CAVITY METHOD, EFFECTIVE FLOOR CAVITY REFLECTANCE 0.20

RC	80	50	30	10
1	71	67	64	63
2	64	58	52	54
3	58	50	44	47
4	53	44	38	41
5	48	39	33	37
6	45	35	29	33
7	41	32	26	30
8	38	29	23	28
9	36	27	21	25
10	34	25	19	23

### ZONAL LUMEN SUMMARY

ZONE	LUMENS	% LAMP	% FIXT
0- 30	1568	15.7	23.6
0- 40	2579	25.8	38.9
0- 60	4687	46.9	70.6
0- 90	6639	66.4	100.0
90-180	0	0.0	0.0
0-180	6639	66.4	100.0

### LUMINANCE DATA IN CANDELA/SQ. METER

AVERAGE IN DEG.	AVERAGE 0-DEG.	AVERAGE 45-DEG.	AVERAGE 90-DEG.
45	2222.	2539.	2776.
55	1929.	2544.	2913.
65	1564.	2681.	3158.
75	1179.	2978.	3442.
85	594.	2890.	3485.

## Ordering Information

Explanation of Catalog Number. Example: CDS2GPF228UNVPG

<b>CD</b> Coffaire Drop Basket Direct/Indirect Recessed	<b>S</b> Body Style: S = Static	<b>2</b> Fixture Width	<b>G</b> Ceiling Type: Fits both Standard Grid and Slot Grid	<b>P</b> Perforated Lamp Shield	<b>F</b> Flat White Reflector	<b>Lamp Quantity</b> 1=1 Lamp 2=2 Lamp 3=3 Lamp	<b>Lamp:</b> (By Others) 28=T5 28W 54=T5HO 54W (Nominal 48")	<b>Voltage:</b> 120, 277 or UNV=120-277	<b>Options:</b> Add appropriate suffix to catalog no., ie: (GLR)
--	---------------------------------------	------------------------------	---	--	-------------------------------------	--	--	---	---

<b>CD</b> Standard Coffaire Drop Basket	<b>YD</b> For NYC Code – Local 3 Manufactured
--	--

## Options/Accessories

**Fusing:** Internal fast blow fusing: SUFFIX: **GLR**.  
Internal slow blow fusing: SUFFIX: **GMF**.  
**Drywall Kit:** Order Catalog Number: **FK92X4**.  
**Electrical Wiring Options:** Consult factory.  
**For motion or light sensor:** See Folio OA20-10.

## Specifications

**Performance:** In an installation of 2 lamp 28W luminaires in a room cavity ratio of 1, with reflectance 80% ceiling, 50% wall, 20% floor, the C.U. shall not be less than .71. To reduce glare the average brightness at 65° shall not exceed 758 candelas per square meter. To control veiling reflections, luminaire output in the 30°-90° zone shall not be less than 76.5%.

**Materials:** Chassis parts are die-formed code gauge steel.  
**Lamp Shield:** 22 gauge steel perforated mesh lamp shield with white acrylic overlay.

## Specifications (continued)

**Finish:** Chassis exterior – baked white polyester enamel. **Cavity** – baked white polyester enamel. Rust preventative undercoating. **Reflector** – low iridescence specular aluminum 95% reflectance.

**Electrical:** Thermally protected class "P" ballast C.B.M. approved, non PCB. If K.O. is within 3" of ballast, use wire suitable for at least 90°.  
UL Listed for damp locations.

**Labels:** I.B.E.W./UL and ULc Listed.  
This product may have a mercury containing lamp. Manage in accord with Disposal Laws. See: www.lamprecycle.org

## Job Information Type:

**Lightolier** a Genlyte company www.lightolier.com  
Technical Information: (978) 657-7600 • Fax (978) 658-0595  
631 Airport Road, Fall River, MA 02720 • (508) 679-8131 • Fax (508) 674-4710  
We reserve the right to change details of design, materials and finish.  
© 2007 a Genlyte company **Section 5/Folio M15-84**