

# Calculite® HID Lensed Wall Wash C6P38MHL

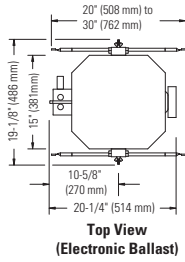

**Top View  
(Electronic Ballast)**

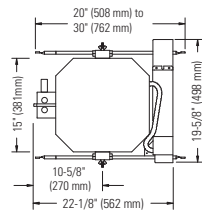

**Top View  
(Magnetic Ballast)**

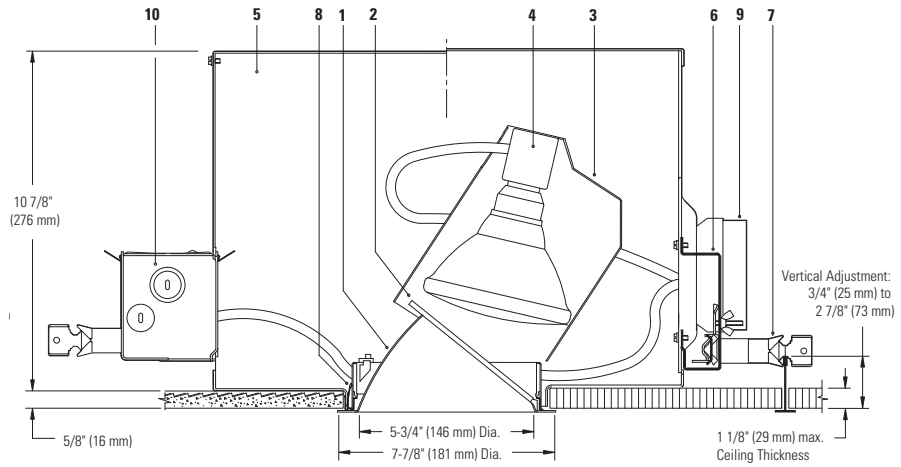

**Ceiling Cutout:** 6 9/16" (167mm) Dia.

Reflector Trim	Frame-In Kit	Lamp (Ceramic MH)
<b>C6P38MHL CLW</b> Specular Clear White Painted Flange.	<b>C6A70P38E1</b> Electronic 120V	70W PAR38 Wide Flood
<b>CLP</b> Specular Clear Matching Flange.	<b>C6A70P38E2</b> Electronic 277V	70W PAR38 Wide Flood
<b>CCDW</b> Comfort Clear Diffuse, White Painted Flange.	<b>C6A10P38E1</b> Electronic 120V	100W PAR38 Wide Flood
<b>CCDP</b> Comfort Clear Diffuse, Matching Flange.	<b>C6A10P38E2</b> Electronic 277V	100W PAR38 Wide Flood
<b>CCZW</b> Champagne Bronze, White Painted Flange.	Magnetic 120V/277V	70W PAR38 Wide Flood
<b>CCZP</b> Champagne Bronze, Matching Flange.	Magnetic 120V/277V	100W PAR38 Wide Flood

## Features

- Reflector Trim:** Low brightness, anodized aluminum; integral flange in painted white or polished to match inside of cone.
- Directional Spread Lens:** High temperature, tempered glass. Precisely fits onto cone; replaceable.
- Kick Reflector:** 0.040" (16 ga.) aluminum. Clear anodized "Kick" reflector with directional spread lens distributes light smooth for vertical surface wall washing.
- Socket:** Medium base porcelain socket with nickel plated screwshell, pulse-rated
- Frame Housing:** Steel, 0.029" (22-Ga.), matte black finish.
- Frame Vertical Adjustment Mechanism:** Accommodates mounting to virtually any ceiling system using pre-installed mounting bars, or 1/2" EMT tubing (by others). Single locking feature secures all adjustments. Alignment holes and markings allow fixture to be pre-set prior to installation. Final adjustment can be made from below from inside fixture.
- Mounting Bars:** Galvanized steel, 0.048" (18-ga.), pre-installed telescoping bars extend to 30" long and lock securely into position. Built-in locking tabs provide positive attachment to common T-bar systems. Self-centering feature simplifies installation in 24" O.C. grid systems. Attaches to steel or wood joists without accessories.
- Retention Springs:** Rust resistant springs secure trim for quick, tool-less installation.
- Ballast / Cover Assembly:** Accessible from below and removable without tools for inspection and ballast replacement.
- Junction Box:** 0.059" (16-ga.) galvanized steel. UL listed for 8 No. 12 AWG, 90°C through branch circuit conductors. Allows inspection from below.
- Thermal Protector:** (Not Shown) Meets NEC and UL requirements. Do Not install insulation above nor within 3" (76mm) of any part of the luminaire.

## Electrical

**Electronic Ballast:** 120V or 277V, 50/60 Hz. Electronic, encased, high power factor, T.H.D. <15%, thermally and transient protected, RMI/RFI complies with FCC part 18 non-consumer limits, shut-down circuit at end of lamp life, sound rating "A", -5° F minimum starting temperature, Type 1 Outdoor rating.

## Electrical (Cont.)

Ballast	ANSI Code	Voltage	Max Amps	Input Watts
70W MH	M98/M143	120/277	0.67/0.28	78
100W MH	M90/M140	120/277	0.90/0.43	110

**Magnetic Ballast:** 120V/277V Dual Voltage, 60Hz Encased and potted, H8-HPF Circuit type, high power factor, sound rating "B", -20° F minimum starting temperature, type 1 outdoor rating.

Ballast	ANSI Code	Voltage	Max Amps	Input Watts
70W MH	M98/M143	120/277	1.90/0.80	94
100W MH	M90/M140	120/277	2.40/1.10	125

## Options and Accessories

**Fuse** (magnetic ballast): Add suffix **F1** or **F2** to FIK (F1=120V F2=277V)

**Chicago Plenum:** Consult Factory.

## Labels

UL (Suitable for Damp Locations), CSA (magnetic ballast only), I.B.E.W.

Job Information	Type:
<b>Job Name:</b>	
<b>Cat. No.:</b>	
<b>Lamp(s):</b>	
<b>Notes:</b>	

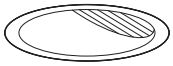

# Calculite® HID Lensed Wall Wash **C6P38MHL**

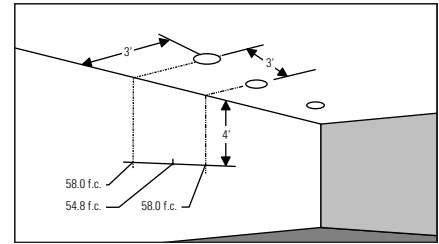

**Lighting Data - Example**  
C6P38MHLCLW illumination on the wall  
4' down from the ceiling is 58.0 f.c.  
beneath and 54.8 f.c. between fixtures.

**CANDLEPOWER DISTRIBUTION**

**70W PAR38 WIDE FLOOD PHILIPS 3K CERAMIC MH. LUMEN RATING = 4800 LMS., AROMAT, ELECTRONIC BALLAST REPORT NO. 2464FR**

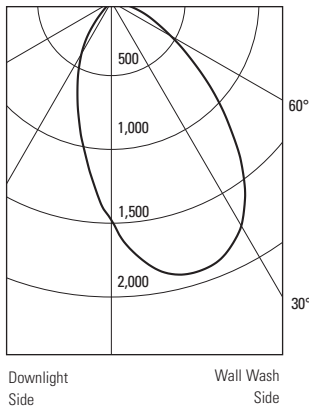

**Multiple Units - Footcandles On Wall**  
3' from Wall - 3' On Center

Distance From Ceiling in Feet	1	2	3	4	5	6	7	8	9	10	11	12	13	14
1	27.2	19.3	27.2											
2	50.8	43.2	50.8											
3	62.2	56.1	62.2											
4	58.0	54.8	58.0											
5	48.5	47.2	48.5											
6	39.1	38.4	39.1											
7	31.7	31.2	31.7											
8	26.3	25.9	26.3											
9	22.1	21.8	22.1											
10	18.9	18.7	18.9											
11	16.5	16.3	16.5											
12	14.6	14.5	14.6											
13	13.3	13.2	13.3											
14	12.5	12.4	12.5											

**Multiple Units - Footcandles On Wall**  
3' from Wall - 4' On Center

Distance From Ceiling in Feet	1	2	3	4	5	6	7	8	9	10	11	12	13	14
1	23.9	10.7	23.9											
2	43.7	26.0	43.7											
3	51.2	36.6	51.2											
4	46.4	37.3	46.3											
5	37.4	33.2	37.4											
6	29.4	27.7	29.4											
7	23.5	22.6	23.5											
8	19.2	18.7	19.1											
9	15.9	15.6	15.9											
10	13.5	13.3	13.5											
11	11.7	11.5	11.7											
12	10.3	10.2	10.3											
13	9.4	9.2	9.3											
14	8.8	8.6	8.8											

**Multiple Units - Footcandles On Wall**  
4' from Wall - 4' On Center

Distance From Ceiling in Feet	1	2	3	4	5	6	7	8	9	10	11	12	13	14
1	11.0	7.6	11.0											
2	22.3	17.7	22.3											
3	31.4	27.4	31.4											
4	35.4	32.0	35.4											
5	34.2	32.1	34.2											
6	30.5	29.4	30.5											
7	26.3	25.7	26.3											
8	22.4	22.1	22.4											
9	19.2	18.9	19.2											
10	16.6	16.4	16.6											
11	14.5	14.3	14.5											
12	12.8	12.7	12.8											
13	11.6	11.4	11.5											
14	10.7	10.6	10.7											

**100W PAR38 WIDE FLOOD PHILIPS 3K WIDE FLOOD CERAMIC MH LAMP. LUMEN RATING = 6800 LMS. AROMAT, ELECTRONIC BALLAST REPORT NO. 2465FR**

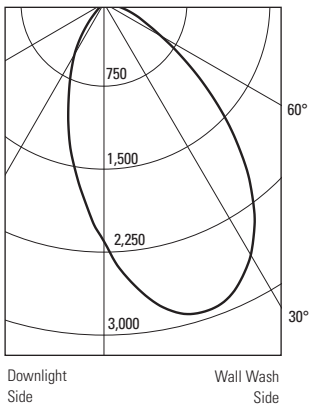

**Multiple Units - Footcandles On Wall**  
3' from Wall - 3' On Center

Distance From Ceiling in Feet	1	2	3	4	5	6	7	8	9	10	11	12	13	14
1	32.7	23.9	32.7											
2	68.2	53.9	68.2											
3	89.6	75.0	89.6											
4	83.8	77.0	83.8											
5	70.4	68.1	70.4											
6	57.2	56.0	57.2											
7	46.6	45.9	46.6											
8	38.6	38.1	38.6											
9	32.4	32.1	32.4											
10	27.7	27.4	27.7											
11	24.0	23.9	24.0											
12	21.3	21.1	21.3											
13	19.3	19.2	19.3											
14	18.1	18.1	18.1											

**Multiple Units - Footcandles On Wall**  
3' from Wall - 4' On Center

Distance From Ceiling in Feet	1	2	3	4	5	6	7	8	9	10	11	12	13	14
1	28.6	13.1	28.6											
2	59.1	32.5	59.0											
3	75.1	48.3	75.1											
4	68.0	51.6	68.0											
5	54.7	47.5	54.7											
6	43.3	40.2	43.3											
7	34.6	33.2	34.6											
8	28.3	27.5	28.2											
9	23.5	23.0	23.5											
10	19.9	19.6	19.9											
11	17.2	17.0	17.2											
12	15.1	15.0	15.1											
13	13.7	13.5	13.6											
14	12.8	12.7	12.8											

**Multiple Units - Footcandles On Wall**  
4' from Wall - 4' On Center

Distance From Ceiling in Feet	1	2	3	4	5	6	7	8	9	10	11	12	13	14
1	13.0	9.3	13.0											
2	27.7	22.0	27.7											
3	43.4	34.7	43.4											
4	50.9	42.8	50.9											
5	49.4	44.6	49.4											
6	44.1	42.0	44.1											
7	38.3	37.3	38.3											
8	32.8	32.3	32.8											
9	28.1	27.8	28.1											
10	24.4	24.1	24.4											
11	21.3	21.2	21.3											
12	18.9	18.7	18.9											
13	17.0	16.9	17.0											
14	15.7	15.6	15.7											

Lighting data above is certified, computed by LSI Program \*\*Test-Lite\*\*

**Job Information** **Type:**

Lightolier a Genlyte company [www.lightolier.com](http://www.lightolier.com)  
631 Airport Road, Fall River, MA 02720 • (508) 679-8131 • Fax (508) 674-4710  
We reserve the right to change details of design, materials and finish.  
© 2006 Genlyte Group LLC • B0406

**LIGHTOLIER®**