

## Ordering Information

Family	Distribution	Lamp Type	No. of Lamps	Housing	Module Length	Wiring	Voltage	Ballast	Finish
<b>BSL</b>	<b>3</b> 3 = Indirect	<b>H</b> H = T5 HO	<b>02</b> 02 = 2 Light	<b>EN</b> EN = Solid	<b>04</b> = 4' <b>08</b> = 8' <b>12</b> = 12'	<b>1</b> = 1cct. <b>2</b> = 2cct. <b>3</b> = 1cct. w/EC/NL <b>4</b> = 2cct. w/EC/NL <b>5</b> = 1cct. w/EM Battery <b>6</b> = 2cct. w/EM Battery <b>7</b> = 1cct. w/Dimming <b>8</b> = 1cct. w/1cct. Thru wire <b>9</b> = 2cct. w/1cct. Thru wire <b>Note:</b> Please consult wiring section of spec sheets for more wiring options.	<b>D</b> = Dual 120V & 277V <b>1</b> = 120V <b>2</b> = 277V	<b>E</b> = Standard <10% THD <b>F</b> = Standard <10% THD w/fusing	<b>C</b> = Custom Color <b>W</b> = Standard White

## Specifications

### Features

- Housing: die-formed 20ga. cold rolled steel
- End Set: die-cast metal with baked powder coat finish
- Lamping: two T5 HO lamps
- Configuration: 4', 8' and 12' module lengths or continuous rows
- Ballasts: electronic 120V or 277V

### Finish

High-quality white powder coat with textured matte finish. Custom colors available. Consult factory.

### Mounting

Aircraft cable gripper is tamper-resistant and provides infinite vertical adjustment capability. Aircraft cable, crimp and cable gripper independently tested to meet stringent safety requirements.

### Electrical

All luminaires are factory pre-wired to module ends with quick-wire connectors.

### Joints & Intersections

Self-aligning joining system with hands-free pre-joining wire access.

### Labels

UL, CSA standards.

## Ordering Instructions

### Individual Fixtures

- Determine the number of individual modules required
- Order one end set per module
- Order one non-power mount per module
- Order one power mount per module

### Continuous Rows\*

- Determine run length
- Order the appropriate number and length of modules for complete run
- Order one end set for each run
- Order one non-power mount for each module
- Order one power mount per run
- Order one joiner per module minus one (e.g. 3 modules requires 2 joiners)

\***Note:** Some runs may require additional power mounts. Please see the 'Run Configuration' table on the next page for more details.

### Job Information

### Type:

**Job Name:**

**Cat. No.:**

**Lamp(s):**

**Notes:**

Lightolier a Genlyte Company

www.lightolier.com

631 Airport Road, Fall River, MA 02720 • (508) 679-8131 • Fax (508) 674-4710

We reserve the right to change details of design, materials and finish.

© 2005 Genlyte Group LLC • 0205 Rev.1

**LIGHTOLIER**

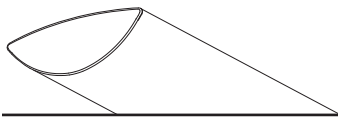

## Performance

### Candlepower Curve

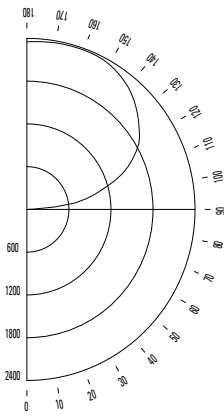

**Report No:** 2101711  
**Lamps:** F54T5  
**Lumens per Lamp:** 4650  
**Efficiency:** 96.9%  
**Up:** 100.0% **Down:** 0.0%

### Candlepower Summary

ZONE DEG.	CANDLEPOWER				
	0	22.5	45	67.5	90
180	2352	2352	2352	2352	2352
175	2339	2344	2352	2359	2363
165	2252	2281	2324	2362	2376
155	2092	2153	2252	2343	2374
145	1862	1966	2143	2269	2305
135	1572	1730	1970	2121	2163
125	1234	1460	1729	1899	1957
115	858	1119	1448	1621	1661
105	475	770	1082	1119	1139
95	113	267	458	389	406
90	5	4	13	6	8
85	0	0	0	0	0
75	0	0	0	0	0
65	0	0	0	0	0
55	0	0	0	0	0
45	0	0	0	0	0
35	0	0	0	0	0
25	0	0	0	0	0
15	0	0	0	0	0
5	0	0	0	0	0
0	0	0	0	0	0

### Coefficients of Utilization

	% EFFECTIVE CEILING CAVITY REFLECTANCE								
	80			70			50		
	% WALL REFLECTANCE								
	50	30	10	50	30	10	50	30	10
0	91	91	91	78	78	78	53	53	53
1	79	76	73	68	65	62	46	44	43
2	69	64	59	59	55	51	40	38	35
3	60	54	49	52	46	42	35	32	30
4	53	46	41	45	40	35	31	28	25
5	47	40	35	40	34	30	28	24	21
6	42	35	29	36	30	26	25	21	18
7	37	30	25	32	26	22	22	18	15
8	34	27	22	29	23	19	20	16	13
9	30	24	19	26	20	17	18	14	12
10	27	21	17	24	18	15	16	13	10

### Zonal Lumen Summary

ZONE	LUMENS	%BARE LAMP	%LUMINAIRE
0-90	0	0	0
90-180	8923	95.9	100.0
0-180	8923	95.9	100.0

## Module Lengths & Mounting Distances

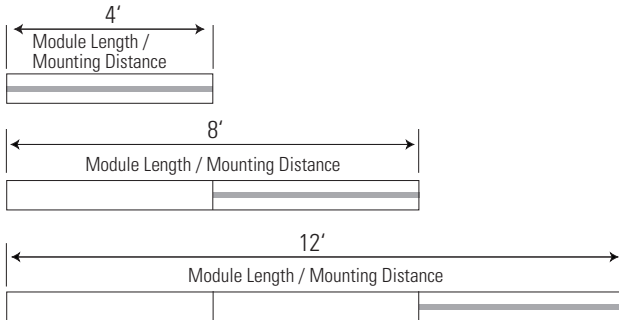

**Note:** Shaded area indicates locations of emergency sections (emergency wiring controls all lamps or optional battery pack controls one or two lamps).

## Run Configuration

Run Length	4' Module	8' Module	12' Module	Joiner	End Set	Mount	Power Mount*
4' run	1				1	1	1
8' run		1			1	1	1
12' run			1		1	1	1
16' run		2		1	1	2	1
20' run		1	1	1	1	2	1
24' run			2	1	1	2	1
28' run		2	1	2	1	3	1
32' run		1	2	2	1	3	1

**\*Note:** Additional power mounts may be required for some runs with T5 HO lamping options, longer runs, and runs with wiring options that are more complex. Please consult factory for assistance.

## System Components & Accessories

### End Set

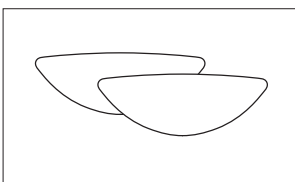

**BSLESW** = suspended standard white

### Joiner

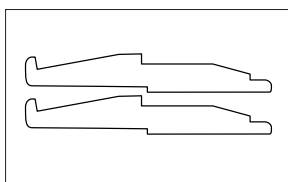

**BSLJS** = suspended joiner

### Job Information

### Type:

**Lightolier** a Genlyte Company [www.lightolier.com](http://www.lightolier.com)  
 631 Airport Road, Fall River, MA 02720 • (508) 679-8131 • Fax (508) 674-4710  
 We reserve the right to change details of design, materials and finish.  
 © 2005 Genlyte Group LLC • 0205 Rev.1

**LIGHTOLIER**

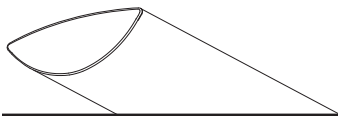

## Mounting Options

### Mount Type: T-Bar 15/16" (On-Grid)\*

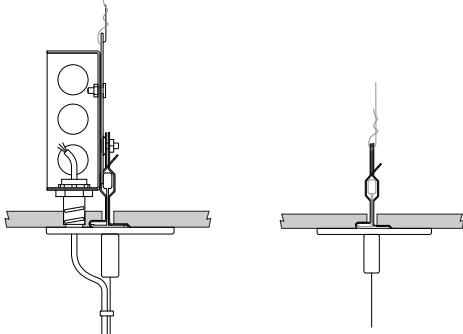

- 65 lbs maximum load
- Canopy: Diameter of 3 3/4" x 7/32"
- Cable: 7x7 stranded aircraft cable
- Supported by T-bar and secured to structure
- J-Box: 4" square (supplied by others)
- Fully adjustable vertically at fixture

1-Power Mount

Non-Power Mount



Supension Length

	2'	4'	8'	12'
1-Power Mount				
3 Conductor	<b>BSLM6102P13</b>	<b>BSLM6104P13</b>	<b>BSLM6108P13</b>	<b>BSLM6112P13</b>
4 Conductor	<b>BSLM6102P14</b>	<b>BSLM6104P14</b>	<b>BSLM6108P14</b>	<b>BSLM6112P14</b>
7 Conductor	<b>BSLM6102P17</b>	<b>BSLM6104P17</b>	<b>BSLM6108P17</b>	<b>BSLM6112P17</b>
Non-Power Mount	<b>BSLM6102N</b>	<b>BSLM6104N</b>	<b>BSLM6108N</b>	<b>BSLM6112N</b>

### Mount Type: T-Bar 9/16" (On-Grid)\*

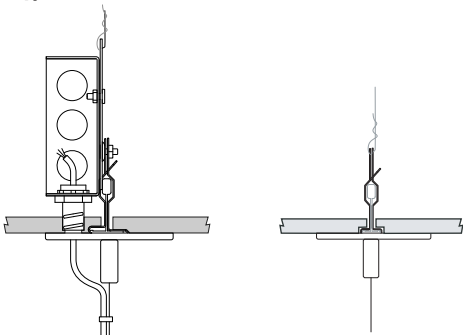

- 65 lbs maximum load
- Canopy: Diameter of 3 3/4" x 7/32"
- Cable: 7x7 stranded aircraft cable
- Supported by T-bar and secured to structure
- J-Box: 4" square (supplied by others)
- Fully adjustable vertically at fixture

1-Power Mount

Non-Power Mount



Supension Length

	2'	4'	8'	12'
1-Power Mount				
3 Conductor	<b>BSLM6202P13</b>	<b>BSLM6204P13</b>	<b>BSLM6208P13</b>	<b>BSLM6212P13</b>
4 Conductor	<b>BSLM6202P14</b>	<b>BSLM6204P14</b>	<b>BSLM6208P14</b>	<b>BSLM6212P14</b>
7 Conductor	<b>BSLM6202P17</b>	<b>BSLM6204P17</b>	<b>BSLM6208P17</b>	<b>BSLM6212P17</b>
Non-Power Mount	<b>BSLM6202N</b>	<b>BSLM6204N</b>	<b>BSLM6208N</b>	<b>BSLM6212N</b>

### Mount Type: T-Bar 9/16" by 5/16" Slot Grid (On-Grid)\*

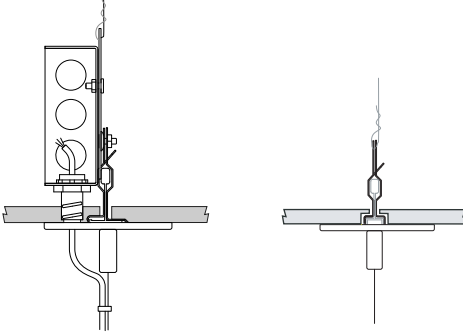

- 65 lbs maximum load
- Canopy: Diameter of 3 3/4" x 7/32"
- Cable: 7x7 stranded aircraft cable
- Supported by T-bar and secured to structure
- J-Box: 4" square (supplied by others)
- Fully adjustable vertically at fixture

1-Power Mount

Non-Power Mount



Supension Length

	2'	4'	8'	12'
1-Power Mount				
3 Conductor	<b>BSLM6302P13</b>	<b>BSLM6304P13</b>	<b>BSLM6308P13</b>	<b>BSLM6312P13</b>
4 Conductor	<b>BSLM6302P14</b>	<b>BSLM6304P14</b>	<b>BSLM6308P14</b>	<b>BSLM6312P14</b>
7 Conductor	<b>BSLM6302P17</b>	<b>BSLM6304P17</b>	<b>BSLM6308P17</b>	<b>BSLM6312P17</b>
Non-Power Mount	<b>BSLM6302N</b>	<b>BSLM6304N</b>	<b>BSLM6308N</b>	<b>BSLM6312N</b>

### Job Information

### Type:

**Lightolier** a Genlyte Company [www.lightolier.com](http://www.lightolier.com)  
 631 Airport Road, Fall River, MA 02720 • (508) 679-8131 • Fax (508) 674-4710  
 We reserve the right to change details of design, materials and finish.  
 © 2005 Genlyte Group LLC • 0205 Rev.1

\*Note: Standard T-bar mounts are currently not available for tegular tile ceilings, however certain tegular tile / T-bar combinations may be supported by the use of the slot-grid mount. For more information, please consult factory.

**LIGHTOLIER**

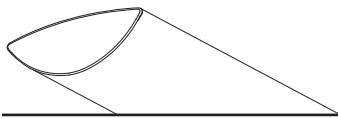

**Mount Type: T-Bar Fixed Position (1/4-20 Threaded Rod)**

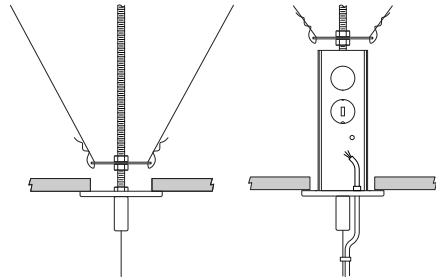

- Meets UBC, OSHPD and DSA seismic requirements
- Canopy: Diameter of 5 1/4" x 3/4" (power)
- Cable: 7x7 stranded aircraft cable
- Tile cut-out hole: Diameter of 2 1/2" (power) or 3/4" (non-power)
- J-Box: Integral J-Box supplied
- 1/4 - 20 all thread rod (supplied by others)
- Fully vertically adjustable at fixture



Supension Length

	2'	4'	8'	12'
1-Power Mount				
3 Conductor	<b>BSLM2102P13</b>	<b>BSLM2104P13</b>	<b>BSLM2108P13</b>	<b>BSLM2112P13</b>
4 Conductor	<b>BSLM2102P14</b>	<b>BSLM2104P14</b>	<b>BSLM2108P14</b>	<b>BSLM2112P14</b>
2-Power Mount				
3 Conductor	<b>BSLM2102P23</b>	<b>BSLM2104P23</b>	<b>BSLM2108P23</b>	<b>BSLM2112P23</b>
Non-Power Mount	<b>BSLM2102N</b>	<b>BSLM2104N</b>	<b>BSLM2108N</b>	<b>BSLM2112N</b>

**Mount Type: T-Bar Variable Position**

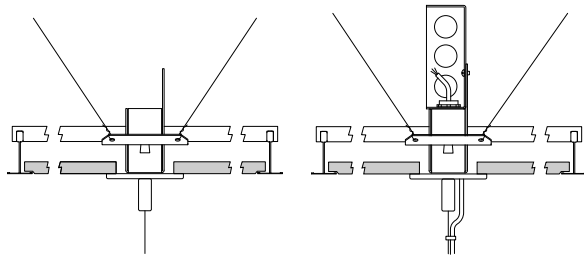

- Meets UBC, OSHPD and DSA seismic requirements
- Canopy: Diameter of 3" x 7/32"
- Cable: 7x7 stranded aircraft cable
- Tile cut-out hole: Diameter of 2 1/4"
- Aligned by T-bar and secured to structure
- J-Box 4" square (supplied by others)
- Fully vertically adjustable at fixture
- Adjusts to both 1" and 1 1/2" high T-bar systems



Supension Length

	2'	4'	8'	12'
1-Power Mount				
3 Conductor	<b>BSLM5102P13</b>	<b>BSLM5104P13</b>	<b>BSLM5108P13</b>	<b>BSLM5112P13</b>
4 Conductor	<b>BSLM5102P14</b>	<b>BSLM5104P14</b>	<b>BSLM5108P14</b>	<b>BSLM5112P14</b>
7 Conductor	<b>BSLM5102P17</b>	<b>BSLM5104P17</b>	<b>BSLM5108P17</b>	<b>BSLM5112P17</b>
2-Power Mount				
3 Conductor	<b>BSLM5102P23</b>	<b>BSLM5104P23</b>	<b>BSLM5108P23</b>	<b>BSLM5112P23</b>
Non-Power Mount	<b>BSLM5102N</b>	<b>BSLM5104N</b>	<b>BSLM5108N</b>	<b>BSLM5112N</b>

**\*Note:** Supports 15/16", 9/16" and slot grid ceiling types.

**Mount Type: Support or Open-Joist Ceiling**

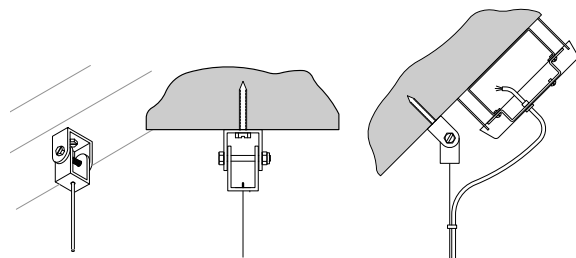

- Meets UBC, OSHPD and DSA seismic requirements
- Canopy: Diameter of 5 1/4" x 3/4" (power)
- Cable: 7x7 stranded aircraft cable
- Versatile mount, fully adjustable to accomodate open sloped ceilings
- J-Box: 4" octogonal box (supplied by others)
- Fully vertically adjustable at fixture



Supension Length

	2'	4'	8'	12'
1-Power Mount				
3 Conductor	<b>BSLM3102P13</b>	<b>BSLM3104P13</b>	<b>BSLM3108P13</b>	<b>BSLM3112P13</b>
4 Conductor	<b>BSLM3102P14</b>	<b>BSLM3104P14</b>	<b>BSLM3108P14</b>	<b>BSLM3112P14</b>
7 Conductor	<b>BSLM3102P17</b>	<b>BSLM3104P17</b>	<b>BSLM3108P17</b>	<b>BSLM3112P17</b>
2-Power Mount				
3 Conductor	<b>BSLM3102P23</b>	<b>BSLM3104P23</b>	<b>BSLM3108P23</b>	<b>BSLM3112P23</b>
Non-Power Mount	<b>BSLM3102N</b>	<b>BSLM3104N</b>	<b>BSLM3108N</b>	<b>BSLM3112N</b>

**Job Information** **Type:**

**Lightolier** a Genlyte Company [www.lightolier.com](http://www.lightolier.com)  
 631 Airport Road, Fall River, MA 02720 • (508) 679-8131 • Fax (508) 674-4710  
 We reserve the right to change details of design, materials and finish.  
 © 2005 Genlyte Group LLC • 0205 Rev.1

**LIGHTOLIER**

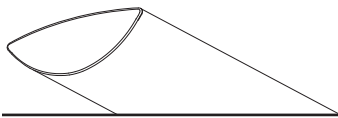

**Mount Type: Non-Accessible Ceilings (concrete, gypsum etc.)**

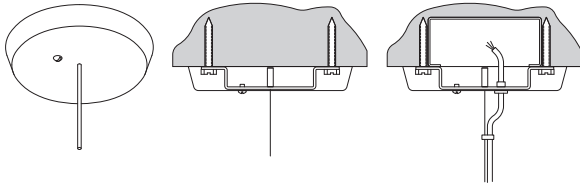

- Meets UBC, OSHPD and DSA seismic requirements
- Canopy: Diameter of 5 1/4" x 3/4" (power)
- Cable: 7x7 stranded aircraft cable
- Mountable on 0° - 15° sloped ceiling
- Optional Chicago Plenum approved version available (A4)
- J-Box: 4" octagonal box (supplied by others)
- Fully vertically adjustable at fixture



**Supension Length**

	2'	4'	8'	12'
1-Power Mount				
3 Conductor	<b>BSLM1102P13</b>	<b>BSLM1104P13</b>	<b>BSLM1108P13</b>	<b>BSLM1112P13</b>
4 Conductor	<b>BSLM1102P14</b>	<b>BSLM1104P14</b>	<b>BSLM1108P14</b>	<b>BSLM1112P14</b>
7 Conductor	<b>BSLM1102P17</b>	<b>BSLM1104P17</b>	<b>BSLM1108P17</b>	<b>BSLM1112P17</b>
2-Power Mount				
3 Conductor	<b>BSLM1102P23</b>	<b>BSLM1104P23</b>	<b>BSLM1108P23</b>	<b>BSLM1112P23</b>
Non-Power Mount	<b>BSLM1102N</b>	<b>BSLM1104N</b>	<b>BSLM1108N</b>	<b>BSLM1112N</b>

## Cord Types

**3 Conductor**

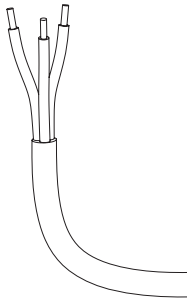

- Max. 10 amps
- Max. 300V

**4 Conductor**

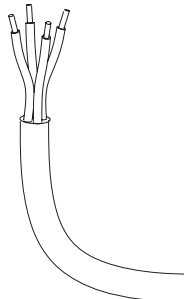

- Max. 10 amps in a 1 circuit application
- Max. 5 amps per circuit in a 2 circuit application
- Max. 300V
- Good for 2 circuit feeds or a 1 circuit feed with a battery pack hot lead
- 120V or 277V applications

**7 Conductor**

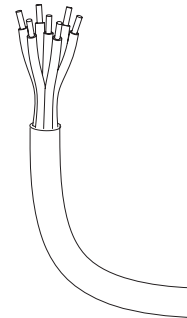

- Max. 10 amps in a 1 circuit application
- Max. 5 amps per circuit in a multi-circuit application
- Good for 3 circuit feeds or 2 circuit feeds with a battery pack hot lead
- 120V or 277V applications

**Job Information**

**Type:**

**Lightolier** a Genlyte Company [www.lightolier.com](http://www.lightolier.com)  
 631 Airport Road, Fall River, MA 02720 • (508) 679-8131 • Fax (508) 674-4710  
 We reserve the right to change details of design, materials and finish.  
 © 2005 Genlyte Group LLC • 0205 Rev.1

**LIGHTOLIER**<sup>®</sup>

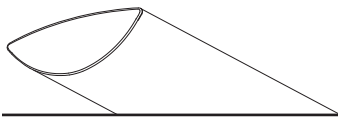

## Wiring Options: 1 Circuit

### 1 Circuit

- Type 1:** 1cct.
- Type 8:** 1cct. w/1cct. thru wire
- Type H:** 1cct. w/2cct. thru wire
- Type 7:** 1cct. w/dimming



All lamps wired on one circuit.

### 1 Circuit with Emergency Circuit/Night Light (EC/NL)

- Type 3:** 1cct. w/EC/NL

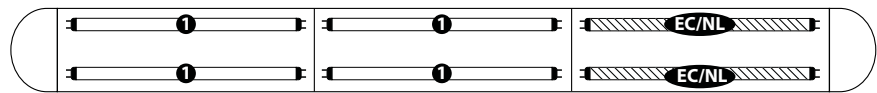

One 4' section in a one circuit fixture to be wired on a separate thru circuit. Leads for both normal circuit and EC/NL circuit wired to fixture ends. All lamps in EC/NL section to be wired together.

### 1 Circuit with Emergency Battery Pack (EM)

- Type 5:** Chloride standard CTP700
- Type M:** Bodine standard LP550
- Type E:** Chloride high performance CTP1300
- Type P:** Bodine high performance LP600

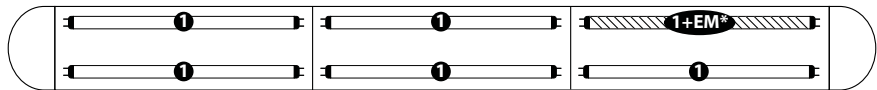

All lamps wired on one circuit, plus a battery pack is wired to one lamp. A hot lead is connected to the battery pack and would function as a 'trigger' wire when connected to a constant hot by installer. Leads for both normal circuit and battery pack are wired to fixture ends.

*\*Note: Multi-lamp battery packs are also available.*

### 1 Circuit with Emergency Circuit/Night Light and Emergency Battery Pack

- Type J:** Chloride standard CTP700

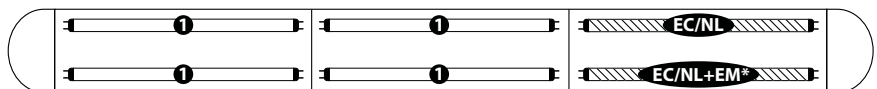

One 4' section in a one circuit fixture to be wired on a separate thru circuit, in addition, a battery pack is wired to one lamp. Installer can connect 'trigger' wire to EC hot lead if controlled together or wire separately if controlled independently. Leads for normal circuit and EM wired to fixture ends. All lamps in EC/NL section to be wired together.

*\*Note: Multi-lamp battery packs are also available.*

#### Job Information

#### Type:

Lightolier a Genlyte Company [www.lightolier.com](http://www.lightolier.com)  
 631 Airport Road, Fall River, MA 02720 • (508) 679-8131 • Fax (508) 674-4710  
 We reserve the right to change details of design, materials and finish.  
 © 2005 Genlyte Group LLC • 0205 Rev.1

# LIGHTOLIER®

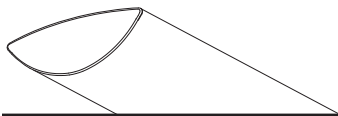

## Wiring Options: 2 Circuit Left/Right Switching

### 2 Circuit Left/Right Switching

- Type 2:** 2cct.
- Type 9:** 2cct. w/1cct. thru wire
- Type I:** 2cct. w/2cct. thru wire

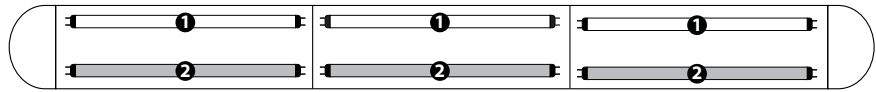

Fixture wired for two circuit. Lamps wired for left/right switching.

### 2 Circuit Left/Right Switching with Emergency Circuit/Night Light (EC/NL)

- Type 4:** 2cct. w/EC/NL

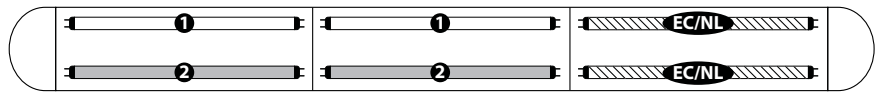

One 4' section in two circuit fixture (left/right switching) to be wired on a separate thru circuit. Leads for both normal circuit and EC/NL circuit wired to fixture ends. All lamps in EC/NL section to be wired together.

### 2 Circuit Left/Right Switching with Emergency Battery Pack (EM)

- Type 6:** Chloride standard CTP700
- Type N:** Bodine standard LP550
- Type F:** Chloride high performance CTP1300
- Type Q:** Bodine high performance LP600

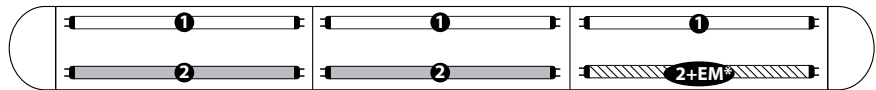

Fixture wired for two circuits (left/right switching), plus a battery pack is wired to one lamp. A hot lead is connected to the battery pack and would act as a 'trigger' wire when connected to a constant hot by installer. Leads for both normal circuit and battery pack are wired to fixture ends.

*\*Note: Multi-lamp battery packs are also available.*

### 2 Circuit Left/Right Switching with Emergency Circuit/Night Light and Emergency Battery Pack

- Type K:** Chloride standard CTP700

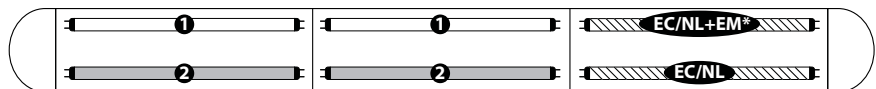

One 4' section in a two circuit fixture (left/right switching) to be wired on a separate thru circuit, in addition, a battery pack is wired to one lamp. Installer can connect 'trigger' wire to EC hot lead if controlled together or wired separately if controlled independently. Leads for both normal circuit, EC/NL and battery pack are wired to fixture ends. All lamps in EC/NL section to be wired together.

*\*Note: Multi-lamp battery packs are also available.*

## Job Information **Type:**

**Lightolier** a Genlyte Company www.lightolier.com  
 631 Airport Road, Fall River, MA 02720 • (508) 679-8131 • Fax (508) 674-4710  
 We reserve the right to change details of design, materials and finish.  
 © 2005 Genlyte Group LLC • 0205 Rev.1

# LIGHTOLIER®

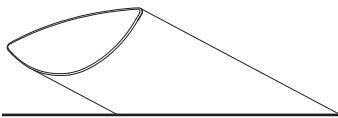

## Wiring Options: 2 Circuit A/B Switching (alternate 4' sections)

### 2 Circuit A/B Switching (alternate 4' sections)

- Type B:** 2cct. A/B
- Type A:** 2cct. A/B w/1cct. thru wire
- Type S:** 2cct. A/B w/2cct. thru wire

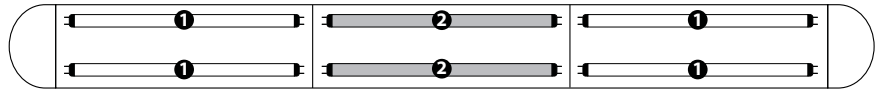

Fixture wired for two circuit. Lamps wired for A/B switching in alternate 4' sections.

### 2 Circuit A/B Switching (alternate 4' sections) with Emergency Circuit/Night Light (EC/NL)

- Type C:** 2cct. w/EC/NL

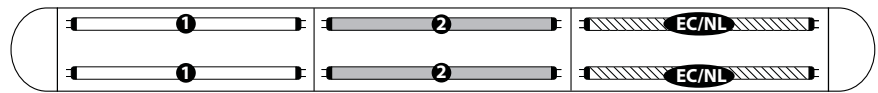

One 4' section in a two circuit fixture (A/B switching) to be wired on a separate thru circuit. Leads for both normal circuit and EC/NL circuit wired to fixture ends. All lamps in EC/NL section to be wired together.

### 2 Circuit A/B Switching (alternate 4' sections) with Emergency Battery Pack (EM)

- Type D:** Chloride standard  
CTP700
- Type O:** Bodine standard  
LP550
- Type G:** Chloride high performance  
CTP1300
- Type R:** Bodine high performance  
LP600

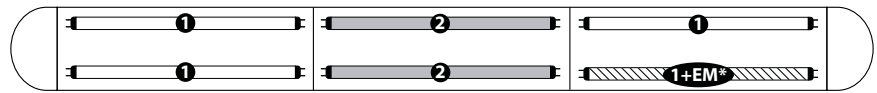

Fixture wired for two circuits (A/B switching), plus a battery pack is wired to one lamp. A hot lead is connected to the battery pack and would act as a 'trigger' wire when connected to a constant hot by installer. Leads for both normal circuit and battery pack are wired to fixture ends.

*\*Note: Multi-lamp battery packs are also available.*

### 2 Circuit A/B Switching (alternate 4' sections) with Emergency Circuit/Night Light and Emergency Battery Pack

- Type L:** Chloride standard  
CTP700

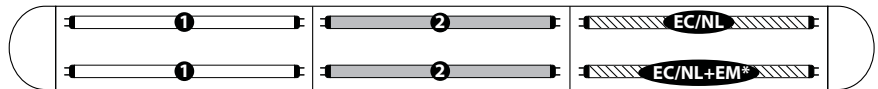

One 4' section in a two circuit fixture (A/B switching) to be wired on a separate thru circuit, in addition, a battery pack is wired to one lamp. Installer can connect 'trigger' wire to EC hot lead if controlled together or wired separately if controlled independently. Leads for normal circuit, EC/NL circuit and battery pack are wired to fixture ends. All lamps in EC/NL section to be wired together.

*\*Note: Multi-lamp battery packs are also available.*

#### Job Information

#### Type:

Lightolier a Genlyte Company [www.lightolier.com](http://www.lightolier.com)  
 631 Airport Road, Fall River, MA 02720 • (508) 679-8131 • Fax (508) 674-4710  
 We reserve the right to change details of design, materials and finish.  
 © 2005 Genlyte Group LLC • 0205 Rev.1