

# Installation Instructions / Warranty

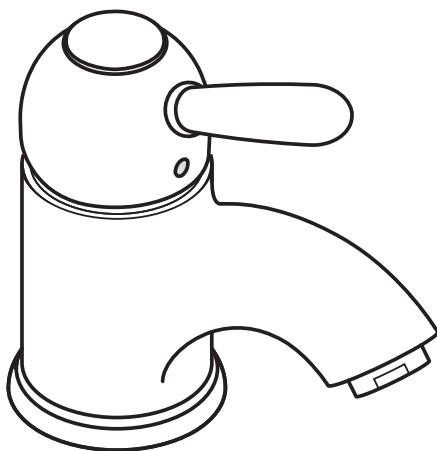

**Axor Carlton**  
17010XX1

**AXOR**<sup>®</sup>

**hansgrohe**

# Axor Carlton Single Control Lavatory Faucet 17010XX1

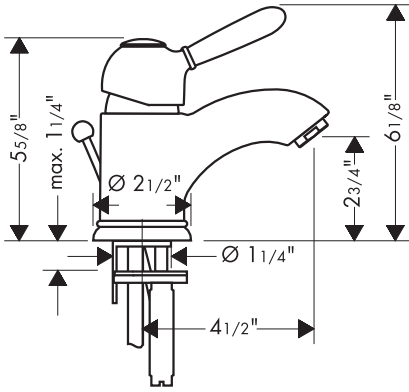

## Technical Specification

Hole size in mounting surface	Minimum 1-3/8"	Maximum 1-5/8"
Maximum mounting surface depth	1-1/4"	
Flow rate	2.2 GPM	
Maximum operating pressure	145 PSI	
Recommended operating pressure	22 - 72.5 PSI	
Recommended hot water temp	120° - 140° F*	
M3 cartridge with Boltic™ handle screw		

\*Some governing bodies require that the water heater be set to 120° F or less. Please know and follow all local codes when setting the temperature on the water heater.

## Installation Considerations

- For best results, Hansgrohe recommends installation by a licensed professional plumber.
- Large differences in pressure between the hot and cold supplies should be balanced.
- The supply hoses on this faucet require supply stops with 3/8" compression fittings (not included).
- This faucet has a high temperature limit stop. It ships from the factory on the maximum setting, but may be reset to a lower temperature if desired.

## Install the faucet

Place the faucet and sealing ring on top of the mounting surface.

Install the mounting flange over the stud. Thread the collar onto the stud until the mounting flange is firmly against the bottom of the mounting surface.

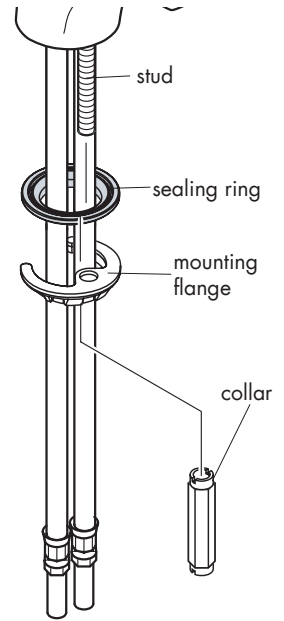

Secure the supply lines to the stop valves with the 3/8" compression fittings (not included).

Use two wrenches to insure that supply hoses do not twist.

For proper operation of the faucet, hot should be on the left, and cold should be on the right.

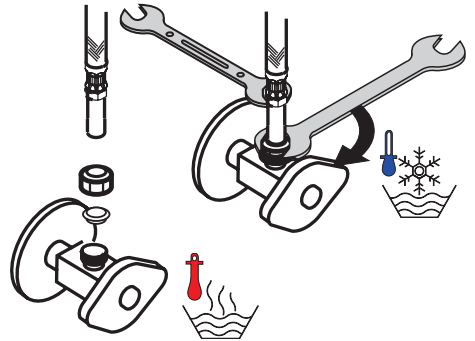

Install the drain.

Re-set the high temperature limit stop (if desired). Install the handle.

Turn on the water and check for leaks at all connections.

## Install the pop-up drain

Remove the plunger assembly.

Unscrew the drain outlet flange from the tee.

Unscrew the tailpiece from the tee. Wrap the threads with two layers of Teflon tape and replace.

Install the white, flexible sealing gasket to the flange. Place it in the sink outlet.

From under the sink, install the black mack gasket, white friction ring and retainer nut to the flange. Do not tighten the nut against the bottom of the sink at this time.

Thread the tee and tailpiece to the flange. The pivot must face the faucet. If necessary, turn the drain assembly.

Tighten the retainer nut.

Place the plunger assembly in the drain.

Install the horizontal rod so that the end goes through the loop in the bottom of the height adjuster.

Install and hand tighten the pivot ball nut.

Attach the swivel connector to the end of the horizontal rod.

Attach the swivel connector to the end of the vertical rod. Position as desired and tighten with a small, flathead screwdriver.

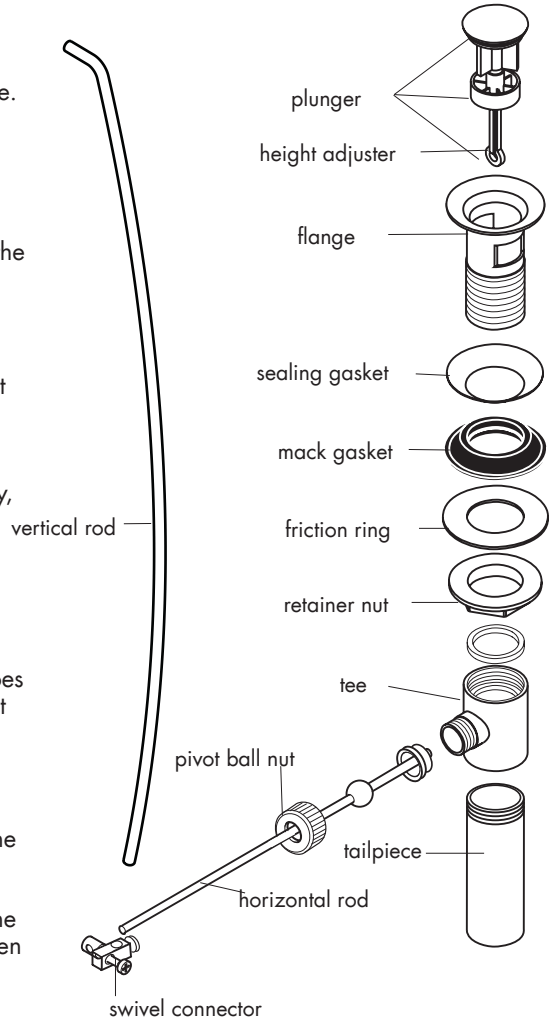

## Re-set the High Temperature Limit Stop (optional)

Close the drain OR cover it with a wash cloth.  
Use a 4 mm Allen wrench to push the screw cover into the handle. Retrieve the screw cover when the handle is removed.

Use the 4mm Allen wrench to loosen the handle screw 4 complete revolutions. Remove the handle and put it in a safe place.

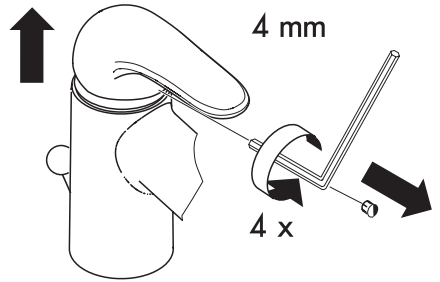

Remove the decorative nut cover and put it in a safe place.

Remove the handle screw from the stem of the cartridge. Remove the high temperature limit stop.

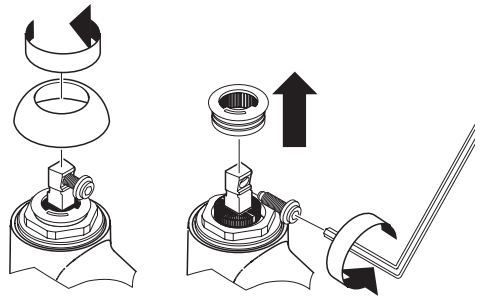

Replace the high temperature limit stop so that the pin on the cartridge is in the desired slot on the limit stop. Note: the temperatures given in the diagram assume a water heater temperature of 140° F, a cold water temperature of 50° F and a water pressure of 45 PSI.

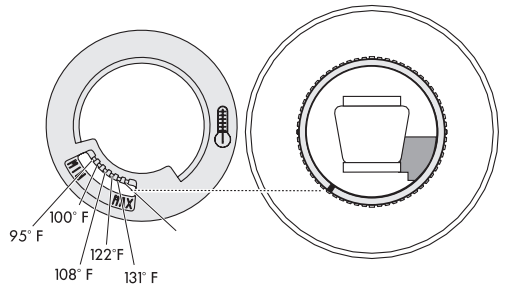

Replace the decorative nut cover. Replace the handle screw. Use the Allen wrench to turn the screw 4 revolutions.

Replace the handle. Finish tightening the handle screw. Turn on the water and test the faucet.

## User Instructions

- Push the handle up to turn the water on.
- Pivot the handle to the left for hotter water, to the right for cooler water.
- Push the handle down to turn the water off.

## Troubleshooting

Problem	Possible Cause	Solution
too little water	debris in aerator	remove and clean aerator
handle hard to turn	debris in cartridge	remove and flush cartridge, replace if necessary
faucet drips	debris in cartridge	remove and flush cartridge, replace if necessary
faucet continues to drip after cartridge is replaced	seal damaged	replace 95008000 seal
too little hot water	high temperature limit stop set incorrectly	reset high temperature limit stop

## Replacement Parts

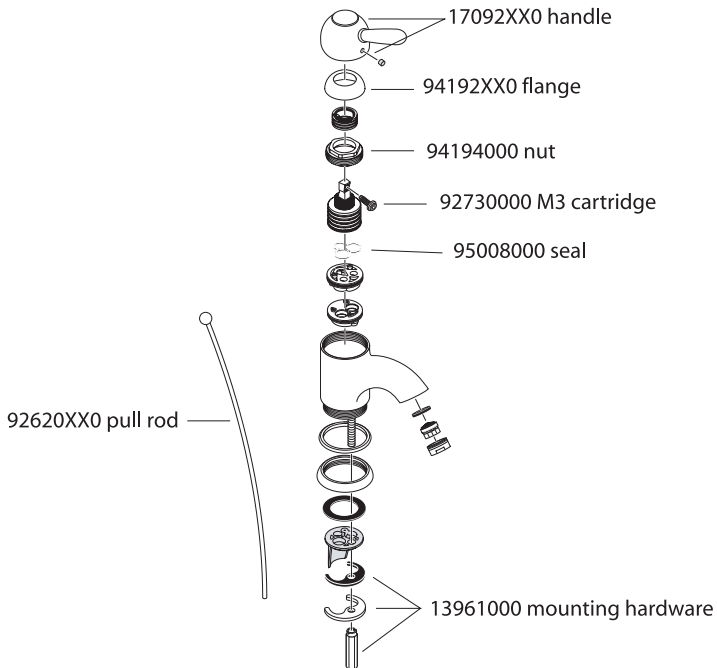

## Cleaning Recommendation for Hansgrohe Products

Modern sanitary faucetry and shower fixtures consist of very different materials to comply with the needs of the market with regard to design and functionality.

To avoid damage and returns, it is necessary to consider certain points when cleaning:

### Cleaning materials for faucets and shower products:

Acids are necessary ingredients of cleaning materials for removing lime. However, please pay attention to the following points when cleaning faucets and shower products:

- Use only cleaning materials intended for the application.
- Never use cleaning materials which contain hydrochloric, formic, or phosphoric, or acetic acid, as these can cause considerable damage.
- Do not mix one cleaning material with another.
- Do not use abrasives, such as cleaning powders, sponge pads, or microfiber cloths.

### Cleaning Instructions for Faucets and Shower Products:

Please follow the cleaning material manufacturer's instructions. In addition, please note the following:

- Clean your faucets and shower products as and when required.
- Follow the label instructions. Do not allow any cleaner to remain on the product for longer than necessary.
- Regular cleaning will prevent scale buildup and water spotting.
- When using spray cleaners, spray first onto a sponge or cloth. Do not spray directly onto the faucet or shower product as drops could enter openings or gaps and cause damage.
- After cleaning, rinse thoroughly with clear water to remove any cleaner residue.

### Important

Residues of liquid soaps, shampoos, and shower foams can also cause damage, so rinse with clean water after using.

### Please note:

- If the surface is already damaged, the effect of cleaning materials will cause further damage.
- Components with damaged surfaces must be replaced, otherwise, this could cause injury.
- Damage caused by improper treatment will not be covered by our warranty.

## Limited Lifetime Consumer Warranty

This product has been manufactured and tested to the highest quality standards by Hansgrohe, Inc. ("Hansgrohe"). This warranty is limited to Hansgrohe products which are purchased by a consumer in the United States after March 1, 1996, and installed in either the United States or Canada.

### WHO IS COVERED BY THE WARRANTY

This warranty extends to the original consumer purchaser only.

### WHAT IS COVERED BY THE WARRANTY

This warranty covers only your Hansgrohe manufactured product. Hansgrohe warrants this product against defects in material or workmanship as follows: Hansgrohe will repair at no charge for parts only or, at its option, replace any product or part of the product which proves defective because of improper workmanship and/or material, under normal installation, use, service and maintenance. If Hansgrohe is unable to provide a replacement and repair is not practical or cannot be timely made, Hansgrohe may elect to refund the purchase price in exchange for the return of the product.

### LENGTH OF WARRANTY

Replacement or repaired parts of products will be covered for the term of this warranty as stated in the following two sentences. If you are a consumer who purchased the product for use primarily for personal, family, or household purposes, this warranty extends for as long as you own the product and the home in which the product is installed. If you purchased the product for use primarily for any other purpose, including, without

limitation, a commercial purpose, this warranty extends only (i) for 1 year, with respect to Interaktiv and Retroaktiv products, and (ii) for 5 years, with respect to AXOR, ShowerPower and Pharo products.

THIS WARRANTY DOES NOT COVER, AND HANSGROHE WILL NOT PAY FOR:

- A. Conditions, malfunctions or damage not resulting from defects in material or workmanship.
- B. Conditions, malfunctions or damage resulting from (1) improper installation, improper maintenance, misuse, abuse, negligence, accident or alteration, or (2) the use of abrasive or caustic cleaning agents or "no rinse" cleaning products, or the use of the product in any manner contrary to the product instructions.
- C. Labor or other expenses for the disconnection or return of the product for warranty service, or for installation or reinstallation of the product.
- D. Accessories or related products not manufactured by Hansgrohe.

TO OBTAIN WARRANTY SERVICE

Contact your Hansgrohe retailer, or write to Technical Service at:

Hansgrohe Inc.  
1492 Bluegrass Lakes Parkway  
Alpharetta GA 30004

Or, call Hansgrohe toll-free at (800) 334-0455.

In requesting warranty service, you will need to provide

- 1. The sales receipt or other evidence of the date and place of purchase.
- 2. A description of the problem.
- 3. Delivery of the product or the defective part, postage prepaid and carefully packed and insured, to Hansgrohe Inc. 1492 Bluegrass Lakes Parkway, Alpharetta, Georgia 30004, Attention: Technical Service, if required by Hansgrohe.

When warranty service is completed, any repaired or replacement product or part will be returned to you postage prepaid.

EXCLUSIONS AND LIMITATIONS

REPAIR OR REPLACEMENT (OR, IN LIMITED CIRCUMSTANCES, REFUND OF THE PURCHASE PRICE) AS PROVIDED UNDER THIS WARRANTY IS THE EXCLUSIVE REMEDY OF THE PURCHASER. HANSGROHE NEITHER ASSUMES NOR AUTHORIZES ANY PERSON TO CREATE FOR IT ANY OBLIGATION OR LIABILITY IN CONNECTION WITH THIS PRODUCT.

HANSGROHE SHALL NOT BE LIABLE TO PURCHASER OR ANY PERSON FOR ANY INCIDENTAL, SPECIAL, OR CONSEQUENTIAL DAMAGES, ARISING OUT OF BREACH OF THIS WARRANTY OR ANY IMPLIED WARRANTY (INCLUDING MERCHANTABILITY).

Some States do not allow the exclusion or limitation of incidental or consequential damages, so the above limitation or exclusion may not apply to you.

This warranty gives you specific legal rights, and you may have other rights which vary from State to State.

You may be required by law to give us a reasonable opportunity to correct or cure any failure to comply before you can bring any action in court against us under the Magnuson-Moss Warranty Act.

PRODUCT INSTRUCTIONS AND QUESTIONS

Upon purchase or prior to installation, please carefully inspect your Hansgrohe product for any damage or visible defect. Prior to installing, always carefully study the enclosed instructions on the proper installation and the care and maintenance of the product. If you have questions at any time about the use, installation, or performance of your Hansgrohe product, or this warranty, please call or write to us at the toll-free number and address printed above.

**hansgrohe**

Hansgrohe, Inc. • 1490 Bluegrass Lakes Parkway • Alpharetta, GA 30004  
Tel. 770 360-9880 • Fax 770 360 9887

**www.hansgrohe-USA.com**