

CMY Zoom 575

User Manual

Elation Professional
4295 Charter Street
Los Angeles, Ca 90058
www.elationlighting.com

CONTENTS

- 1. General Information..... 3
 - a. Introduction..... 3
 - b. Unpacking..... 3
 - c. Customer Support..... 3
 - d. Warranty Registration..... 4
 - e. Discharge Lamp Warning..... 4
- 2. Safety Instructions..... 7
- 3. Features..... 9
- 4. General Guidelines..... 10
- 5. Lamp Installation..... 11
 - a. Lamp installation..... 11
 - b. Lamp optimization..... 12
- 6. Mounting and Installation..... 14
 - a. Mounting Positions..... 14
 - b. Mounting Points..... 15
 - c. Securing..... 16
- 7. Understanding DMX..... 17
 - a. DMX Connections..... 17
 - b. DMX Terminator..... 18
 - c. 3-Pin to 5-Pin Conversion..... 19
 - d. DMX Addressing..... 19
- 8. Display Indicators..... 21
- 9. Fixture Menu..... 22
 - a. Menu functions..... 24
- 10. DMX Channel Traits..... 39
 - a. DMX Channel Values..... 40
- 11. Error Codes..... 43
- 12. Cleaning and Maintenance..... 45
- 13. Warranty..... 46
- 14. Photometric Data..... 48
- 15. Dimensional Drawings..... 49
- 16. Circuit Schematic..... 50
- 17. Technical Specifications..... 51

1. GENERAL INFORMATION

INTRODUCTION: Congratulations, you have just purchased one of the most innovative and reliable lighting fixtures on the market today! The CMY Zoom 575,™ has been designed to perform reliably for years when the guidelines in this booklet are followed. Please read and understand the instructions in this manual carefully and thoroughly before attempting to operate this unit. These instructions contain important information regarding safety during use and maintenance.

UNPACKING: Thank you for purchasing the CMY Zoom 575™ by Elation Professional®. Every CMY Zoom 575™ has been thoroughly tested and has been shipped in perfect operating condition. Carefully check the shipping carton for damage that may have occurred during shipping. If the carton appears to be damaged, carefully inspect your unit for damage and be sure all accessories necessary to operate the unit have arrived intact. In the event damage has been found or parts are missing, please contact our customer support team for further instructions. Please do not return this unit to your dealer without first contacting customer support at the number listed below.

CUSTOMER SUPPORT: Elation Professional® provides a customer support line, to provide set up help and to answer any question should you encounter problems during your set up or initial operation. You may also visit us on the web at www.elationlighting.com for any comments or suggestions. For service related issue please contact Elation Professional®. Service Hours are Monday through Friday 9:00 a.m. to 5:00 p.m. Pacific Standard Time.

Voice: (323) 582-3322

Fax: (323) 582-3108

E-mail: support@elationlighting.com

Forum: www.ElationLighting.com/forum

Warning! To prevent or reduce the risk of electrical shock or fire, do not expose this unit to rain or moisture.

Caution! There are no user serviceable parts inside this unit. Do not attempt any repairs yourself, doing so will void your manufactures warranty.

Please do not discard the shipping carton in the trash. Please recycle whenever possible.

WARRANTY REGISTRATION: The CMY Zoom 575™ carries a two year (730 days) limited warranty. Please fill out the enclosed warranty card to validate your purchase. All returned service items whether under warranty or not, must be freight pre-paid and accompany a return authorization (R.A.) number. The R.A. number must be clearly written on the outside of the return package. A brief description of the problem as well as the R.A. number must also be written down on a piece of paper and included in the shipping container. If the unit is under warranty, you must provide a copy of your proof of purchase invoice. Items returned without a R.A. number clearly marked on the outside of the package will be refused and returned at customer's expense. You may obtain a R.A. number by contacting customer support at (323) 582-3322.

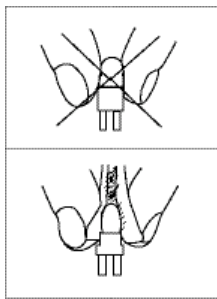

DISCHARGE LAMP WARNING: This fixture is fitted with a discharge lamp, which is highly susceptible to damage if improperly handled. Never touch the lamp with your bare hands, as the oil from your hands will shorten lamp life. Also, never move the fixture until the lamps have had ample time to cool. Remember, lamps are not covered under warranty conditions.

This fixture emits intense UV radiation, which is harmful to the eyes and skin. The intense luminance of the lamp can cause severe damage to the retina. Never operate this fixture with the protective covers removed, these covers have been specially designed to shield against UV radiation.

Epileptic Warning: *Those suffering from epilepsy should avoid looking directly into the lamp at all times.*

Avoid switching the fixture on and off repeatedly in short intervals, as this will reduce lamp life and intensity.

To achieve the intensity associated with discharge lamps, these lamps use a gas sealed in a high-pressure environment to emit a brilliant output. Due to the high pressure involved with the construction of the lamp, the lamp may explode during prolonged extensive use. This risk is increased with age; added care is encouraged when dealing with older lamps.

Thus, lamp should always be replaced at the end of their recommended duty cycle. Extreme caution should be used when operated this or any fixture fitted with a gas discharge lamp.

Never open this fixture while in use!

During the initial operation of this fixture, a light smoke or smell may emit from the interior of the fixture. This is a normal process and is caused by excess paint in the interior of the casing burning off from the heat associated with the lamp and will decrease gradually over time.

This device falls under protection-class I. Therefore it is essential that the device be grounded properly.

All electrical connections must performed by qualified personal.

Be sure the available voltage matches the voltage requirements of the unit.

Be sure the power cord is never crimped or damaged. If the power cord is damaged, replace it immediately with a new one of similar power rating.

Always disconnect from main power before performing any type of service or any cleaning procedure.

Only handle the power cord by the plug. Never pull out the plug by tugging the wire portion of the cord.

Please be aware that damages caused by manual modifications to the device are not subject to warranty.

2. SAFETY INSTRUCTIONS



The CMY Zoom 575™ is an extremely sophisticated piece of electronic equipment. To guarantee a smooth operation, it is important to follow the guidelines in this manual. The manufacturer of this device will not accept responsibility for damages resulting from the misuse of this fixture due to the disregard of the information printed in this manual.

1. Always be sure that the fan and the air inlets remain clean and are never blocked. Allow about 6" (15cm) between this fixture and other devices or a wall to allow for proper cooling.
2. Never touch the fixture during normal operation. This can cause severe personal injuries and/or damage to the fixture.
3. Be sure to unplug the CMY ZOOM 575™ from the power outlet before performing any service related issues.
4. Lamp Replacement; Allow at least 30 minutes after disconnecting main power before you open the CMY ZOOM 575™. To prevent personal injury, never touch the lamp if you are not absolutely sure it has cooled.
5. Never look directly into the lamp beam. You risk injury to your retina, which may induce blindness.
6. Be sure to track and record the lamp running time. The lamp should be changed at the end of the specified lamp life, regardless of lamp output. You may also have to change the lamp if it shows any deformations or damage. The same is with all glass components, color filters, lenses and mirrors.
7. For safe operation, follow the Installation guide described in chapter two of this manual. Operating the CMY ZOOM 575™ without suited safety aids such as safety cables or clamps can increase the risk of damage and/or personal injury.
8. Installation should only be performed by qualified and certified personal.
9. When mounting this fixture, use only the original rigging parts included with this fixture. Any structural modification will void the original manufactures warranty and

may increase the risk of damage and/or personal injury.

10. To reduce the risk of fire or shock, do not expose this fixture to rain or moisture.
11. Do not attempt to operate this fixture if the power cord has become damaged or frayed.

Important Notice: Damages resulting from the disregard of safety and general user instructions found in this user manual are not subject to any warranty claims.



CAUTION!

Never touch the device during operation!
The housing may heat up



CAUTION!

Never look directly into the light source,
as sensitive persons may suffer an epileptic shock.

3. FEATURES

- 3 operation mode:
 - DMX controlled,
 - Stand alone
 - Sound activated
- 10 Dichroic Filters (7 Colors, UV Filter, CTB 64K Filter, CTC 32K Filter, plus white)
- User selectable color change (mode 1: full colors, mode 2: split-colors)
- CMY Subtractive Color Mixing
- Strobe effect: 0~13 flashes per second or random strobe
- Bright Phillips MSR 575/2 Lamp (575w / 7200K / 1000Hrs / 49,000Lm)
- Dimmer intensity from 0%~100%
- Dual Flag Mechanical Dimming
- User Selectable Power Supply (Internal)
- Control board with 4-digit display and foil-keyboard
- Digital display can be turned 180° to fit different installation position
- RDMX (Remote DMX addressing from any DMX console)
- Auto test for all functions
- Glass Dichroic Reflector for Even Lamp Output
- Anti-Reflective Coated Lenses
- USITT DMX-512 Complaint
- Value of each DMX-channel can be displayed
- Motorized Zoom 7° ~ 28*°
- 150mm Fresnel Lens
- 8 User Assignable Program Presets - Internal Program: Edit and save programs to the incorporated EEPROM through the front control panel or external controller; you can save a maximum of 48 scenes, and run the saved programs by using the “run” menu on the front control panel

4. GENERAL GUIDELINES

This fixture is a professional lighting effect designed for use on stage, in nightclubs, in theatres, etc. Do not attempt operation or installation without a proper knowledge on how to so.

This fixture was designed for indoor use only, use of this fixture outside will void manufactures warranty.

Consistent operational breaks may ensure that the fixture will function properly for many years to come.

Do not shake the fixture around. Avoid brute force when installing or operating the device.

While choosing an installation location, please be sure that the fixture will not be exposed to extreme heat, moisture or dust. The minimum distance between the fixture and a wall or flat surface should be at least .5 meter (about 1.5ft).

Always install the fixture with an appropriate safety cable. When installing the fixture in a suspended environment always be to use mounting hardware no less than M10 x 25 mm, also be sure the hardware is insert in the pre-arranged screw holes in the base of the fixture.

Do not attempt to operate this fixture until you have familiarized yourself with its functions.

Do not permit operation by persons not qualified for operating this type of theatrical fixture, most damages are the result of operation by nonprofessionals.

Please use the original packaging to transport the fixture in for service.

5. LAMP INSTALLATION INSTRUCTIONS

Installing or replacing the lamp



CAUTION!

Only install the lamp with the device unplugged from the mains.



CAUTION!

The lamp has to be replaced when it is damaged or deformed.

Before replacing the lamp, be sure the unit has had ample time to cool. To avoid self injury, never touch the lamp when it is hot.

During the installation of the discharge lamp do not touch the glass portion of the bulb with your bare hands. Always use a cloth to handle the lamps during insertion and removal.

Do not install lamps with a higher wattage than that specified by the manufacture, they generate higher temperatures than which the device is designed to cool and may explode.

Installation Procedure:

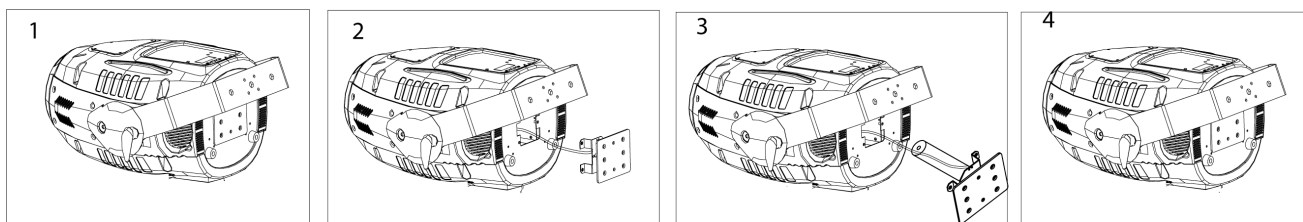

1. Lay the fixture on its' back and remove the two Phillips screws labeled "A" and "B" found on the bottom plate of the fixture.
2. Gently pull out the lamp/socket assembly to access the lamp.
3. Gently remove the old lamp by grasping it by the ceramic base.
4. Carefully insert the new lamp into the socket (Only use a MSR 575/2 GX9.5 lamp or

equivalent). Please remember there is only one way to insert the lamp and the lamp should fit completely in the lamp socket.

5. Once the lamp has been inserted into the socket, gently slide the socket assembly back into place and secure with the two Phillips screws.
6. Always be sure to optimize the lamp after lamp replacement.



CAUTION!

Do not operate this device with open cover

Lamp Optimization

The lamp orientation and optimization must be adjusted after every lamp change. This procedure centers the lamp in the reflector. Proper optimization will increase lamp life and ensure a bright crisp output. Improper optimization may add a yellow tint to the lamp output and reduce intensity. The minimum deviation amount is 1.0mm. Running the fixture within a lower deviation can cause damage to the lamp and/or lens.

The **CMY Zoom 575™** lamp holder is aligned at the factory. However, due to slight imperfections in all lamps, fine adjustments will improve light performance. Please follow the procedure below for proper lamp optimization:

1. Using either a DMX controller or the control panel on the unit (see “SPOT” in the fixture menu on page 33), strike the lamp and focus the light on a flat surface (beam open, white, no gobo, no effect).
2. Center the hot-spot (the brightest part of the beam) using the 3 adjustment screws labeled 1, 2, and 3 as illustrated on the next page. Turn one screw at a time to drag the hot-spot diagonally across the projected image. If you cannot detect a hot-spot, adjust the lamp until the light is even.
3. To reduce a hot-spot, pull the lamp in by turning all three screws clockwise a 1/4-turn at a time until the light is evenly distributed.
4. If the light is brighter around the edge than it is in the center, or if light output is low, the lamp is too far back in the reflector. “Push” the lamp out by turning each of the

adjustment screws ("1, 2, 3") counterclockwise turn until the light is bright and evenly distributed.

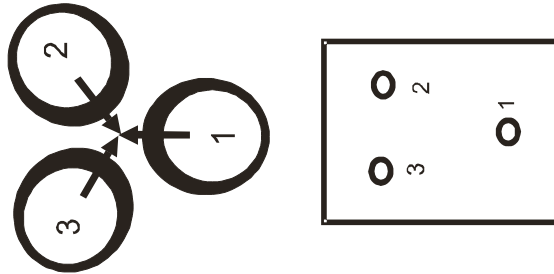

Please remember that a MSD 575/2 lamp is not a hot-restrike lamp therefore, you should wait at least 15 minutes before attempting to strike the lamp once it has been turned off.

6. MOUNTING and INSTALLATION

Cautions:

For added protection mount the fixtures in areas outside walking paths, seating areas, or in areas where the fixture might be reached by unauthorized personnel.

Before mounting the fixture to any surface, make sure that the installation area can hold a minimum point load of 10 times the device's weight.

Fixture installation must always be secured with a secondary safety attachment, such as an appropriate safety cable.

Never stand directly below the device when mounting, removing, or servicing the fixture.



CAUTION!
Before taking into operation for the first time, the installation has to be approved by an expert.



CAUTION!
When installing the device, make sure there is no highly inflammable material within a distance of min. 0,5m

Mounting

The CMY ZOOM 575™ is fully operational in three different mounting positions, hanging upside-down from a ceiling, side mounted, or set on a flat level surface (see illustration below). Be sure this fixture is kept at least 0.5m away from any flammable materials (decoration etc.). Always use and install the supplied safety cable as a safety measure to prevent accidental damage in the event of a clamp.



Refer to regulations BGV C1 (formerly VBG 70) and DIN VDE0711-217 for proper installation in Europe To ensure proper installation, only qualified staff should attempt installation.

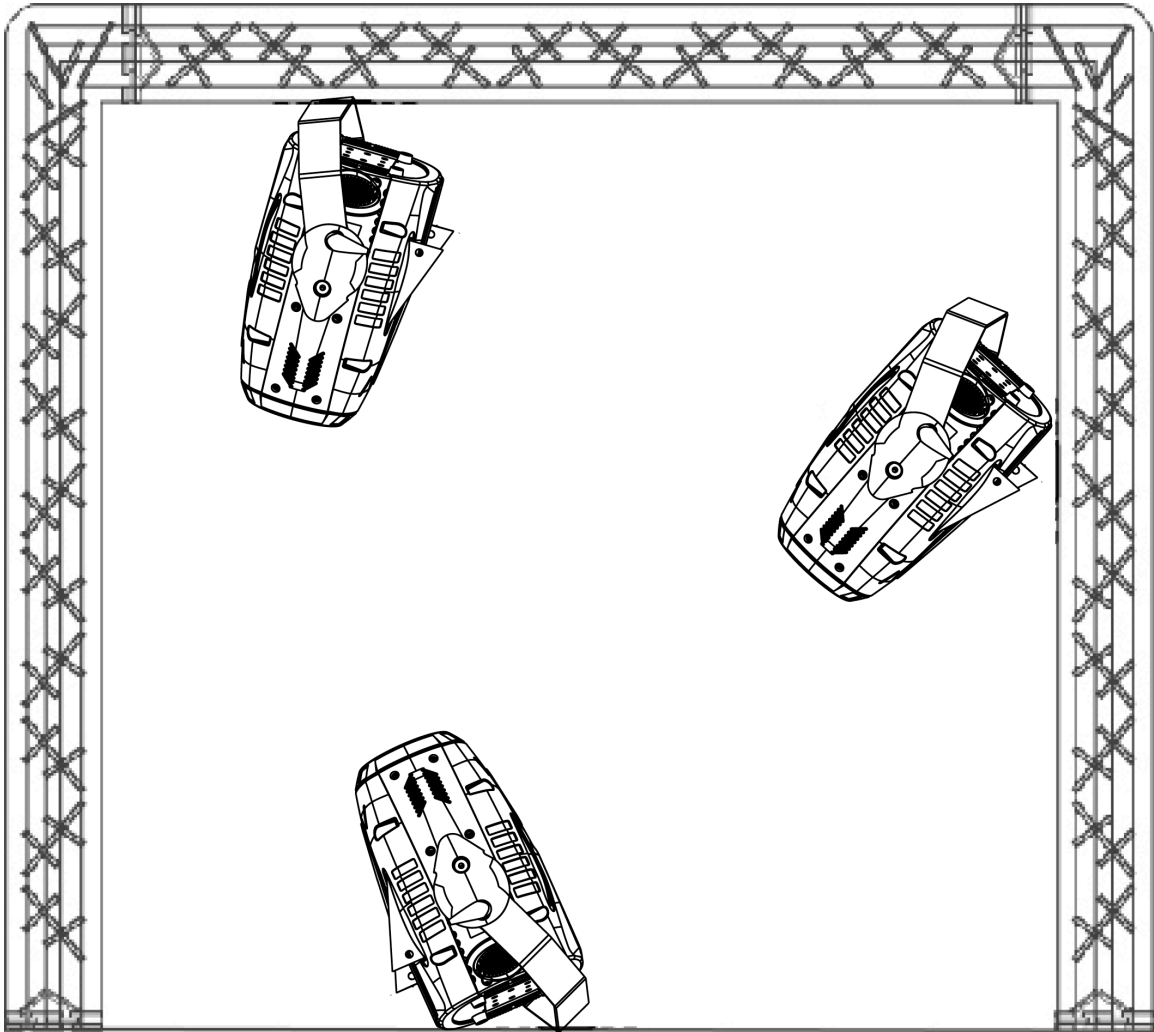

Mounting points

Overhead mounting requires extensive experience, including amongst others calculating working load limits, a fine knowledge of the installation material being used, and periodic safety inspection of all installation material and the fixture. If you lack these qualifications, do not attempt the installation yourself. Improper installation can result in bodily injury.



CAUTION!

The electric connection must only be carried out by a qualified electrician.

Be sure to complete all rigging and installation procedures before connecting the main power cord to the appropriate wall outlet.

Clamp Mounting

The CMY Zoom 575™ provides a unique mounting bracket assembly that integrates the hanging yoke as well as the safety cable rigging point in one unit (see the illustration below). When mounting this fixture to truss be sure to secure an appropriately rated clamp to the hanging yoke using a M10 screw fitted through the center hole of the hanging yoke. As an added safety measure be sure to attached at least one properly rated safety cable to the fixture using on of the safety cable rigging point integrated in the bracket assembly

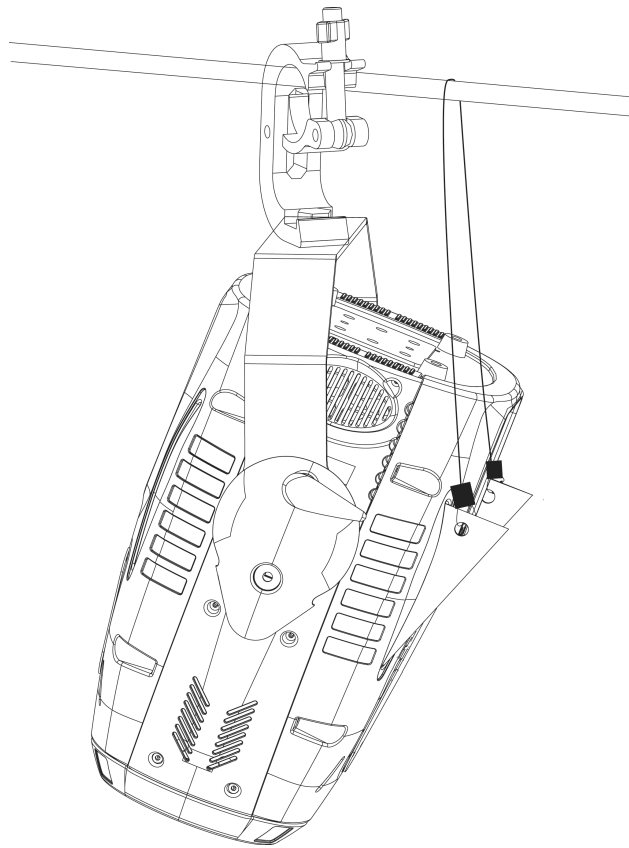

Securing the CMY ZOOM 575™

Regardless of the rigging option you choose for your CMY ZOOM 575™ always be sure to secure your fixture with a safety cable. The fixture provides a built-in rigging point for a safety cable on the hanging bracket as illustrated above. Be sure to only use the designated rigging point for the safety cable and never secure a safety cable to a carrying handle.

7. Understanding DMX

Data Cable (DMX Cable) Requirements (For DMX and Master/Slave Operation):

Your fixture and your DMX controller require a standard 3-pin XLR connector for data input and data output (see figure below). If you are constructing your own cables be sure to use two conductor shielded digital cable rated at a 120 ohms (this cable can be purchased at almost all professional sound and lighting stores). Your cables should be made with a male and female 3-pin XLR connector on either end of the cable.

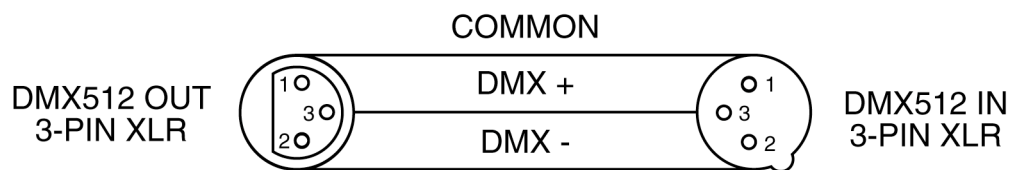

Be sure to follow the above figure when making your own cables. Do not use the ground lug on the XLR connector. Do not connect the cable's shield conductor to the ground lug or allow the shield conductor to come in contact with the XLR's outer casing. Grounding the shield could cause a short circuit and erratic behavior.

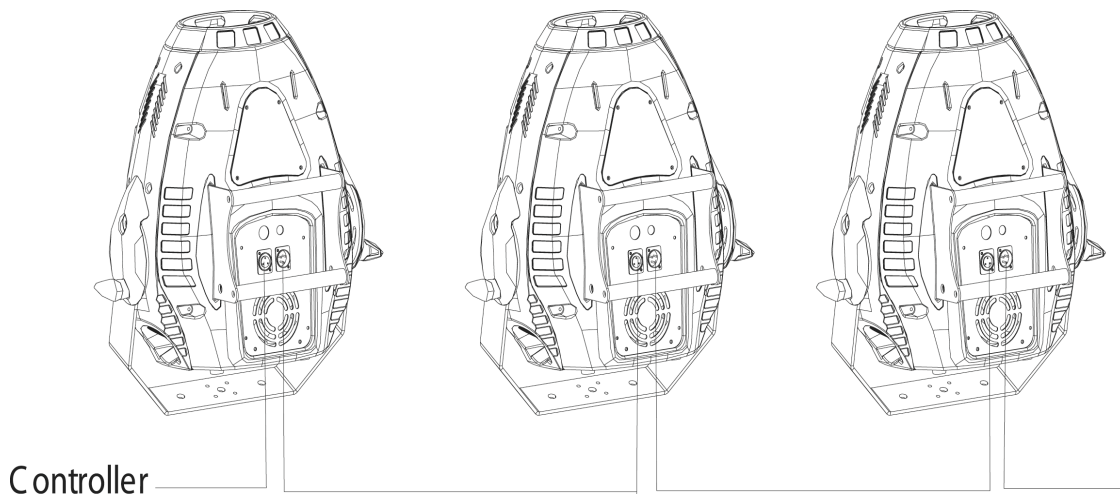

DMX-512 control connection

Connect the provided XLR cable to the female 3-pin XLR output of your controller and the

other side to the male 3-pin XLR input of the moving head (Please refer to the diagram below.). You can chain multiple moving heads together through serial linking. The cable needed should be two conductor, shielded cable with XLR input and output connectors. Always be sure daisy chain your in and out data connections, never split or “Y” your DMX connections unless you are using an approved DMX splitter such as the Elation Opto Branch 4™ or DMX Branch/4™.

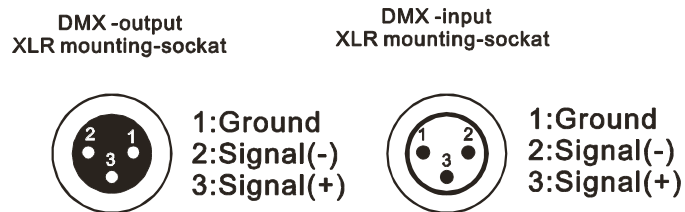

DMX-512 connection with DMX terminator

When longer runs of cable are used, you may need to use a terminator on the last fixture to avoid erratic behavior. A terminator is a 90-120 ohm 1/4 watt resistor that is connected between pins 2 and 3 of a male XLR connector (DATA + and DATA -). This fixture is inserted in the female XLR connector of the last fixture in your daisy chain to terminate the line. Using a cable terminator (Elation part number Z-DMX/T) will decrease the possibilities of erratic behavior.

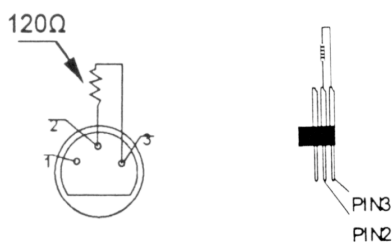

Termination reduces signal errors and avoids signal transmission problems and interference. It is always advisable to connect a DMX terminal, (Resistance 120 Ohm 1/4 W) between PIN 2 (DMX-) and PIN 3 (DMX +) of the last fixture.

5-Pin XLR DMX Connectors. Some manufactures use 5-pin XLR connectors for DATA transmission in place of 3-pin. 5-pin XLR fixtures may be implemented in a 3-pin XLR DMX line. When inserting standard 5-pin XLR connectors in to a 3-pin line a cable adaptor must be used, these adaptors are readily available at most electric stores. The following chart details a proper cable conversion.

3-Pin XLR to 5-Pin XLR Conversion		
Conductor	3-Pin XLR Female (Out)	5-Pin XLR Male (In)
Ground/Shield	Pin 1	Pin 1
Data Compliment (- signal)	Pin 2	Pin 2
Data True (+ signal)	Pin 3	Pin 3
Not Used		Pin 4 - Do Not Use
Not Used		Pin 5 - Do Not Use

Fixture DMX addressing;

All fixtures should be given a DMX starting address when using a DMX controller, so the correct fixture responds to the correct control signal. This digital starting address is the channel number from which the fixture starts to “listen” to the digital control information sent out from the DMX controller. The allocation of this starting DMX address is achieved by setting the correct DMX address on the digital display located on the head of the fixture.

You can set the same starting address for all fixtures or a group of fixtures, or set different address for each individual fixture. Be advised that setting all you fixtures to the same DMX address will subsequently control all fixtures in the same fashion, in other words, changing the settings of one channel will affect all the fixtures simultaneously.

If you set each fixture to a different DMX address, each unit will start to “listen” to the channel number you have set, based on the quantity of control channels (DMX channels) of each fixture. That means changing the settings of one channel will only affect the selected fixture.

In the case of the CMY Zoom 575™, which is a 11 channel fixture, you should set the starting DMX address of the first unit to 1, the second unit to 12 (11 + 1), the third unit to 23 (11 + 12), and so on.

Note: During start-up the CMY Zoom 575™ will automatically detect whether a DMX data signal is being received or not. If DMX data signal is being received, the display will show "**A.XXX**" (XXX representing the actual DMX address). If the fixture is not receiving a DMX

signal the display will flash "**A.XXX**" (**XXX** representing the actual DMX address).

If your fixture is connected to a DMX controller and the display is flashing (not receiving a DMX signal), please check the following:

- The 3 PIN XLR plug (cable with DMX signal from controller) is not connected or is not inserted completely into the DMX input jack.
- The DMX controller is switched off or defective.
- The DMX cable or connector is defective.
- A DMX terminator has been inserted into the last fixture in your DMX chain.

8. DISPLAY LED INDICATORS

The CMY Zoom 575™ has two LED indicators on the display. These indicators are designed to give a quick visual indication of the fixtures' status. The illustration below details the functionality of the LED indicators.

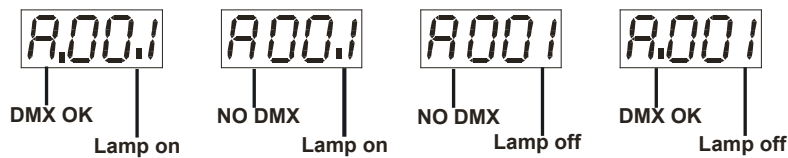

The first LED indicators represents DMX signal:

- If the indicators is on a clean DMX signal is present
- If the indicator is off there is no DMX signal present

The second LED indicator represents lamp condition:

- If the indicator is on the lamp is struck and in working condition
- If the LED indicator is off the lamp has not struck, has been turned off, or is bad.

9. FIXTURE MENU

On-Board System Menu: The CMY ZOOM 575™ comes with an easy to navigate system menu. This next section will detail the functions of each command in the system menu.

LED Control Panel: The control panel located on the top, front of the fixture allows you to access the main menu and make all necessary adjustments to the **CMY Zoom 575™**. During normal operation, tapping the “**MODE/ESC**” key once will access the fixture’s main menu. Once in the main menu you can navigate through the different functions and access the sub-menus with the **Up** and **Down** buttons. Once you reach a field that requires adjusting, tap the **ENTER** button to activate that field and use the **UP** and **Down** button to adjust the field. Tapping the **Enter** button once more will confirm your setting. Once a setting is saved the LED will briefly readout **PASS** to confirm a new setting has been made and locked into memory. You may exit the main menu at any time without making any adjustments by tapping the **MODE/ESC** button.

MODE/ESC Button - To access the main menu locate the MODE/ESC button on the front of the unit. Press this button to activate the system menu. Tap the UP button until you reach the function you wish to change. When you reach the function you wish to change tap the ENTER button once to select that menu function. When a function is selected the menu will begin to flash, use the UP or DOWN button to change the function. Once your changes are made tap the ENTER button yet again to lock the change in the system menu. To exit without making any changes tap the MODE/ESC button.

Default settings are shaded.

0	ADDR	AXXX A001		Indicate the starting DMX address A001 also is the setting for slave
1	TEST	T-01~T-XX		Automatically test the function
2	PLAY	RUN	MSTR/ALON	Runs fixture as “master” or “alone” for auto
		AUDI	MSTR/ALON	Runs fixture as “master” or “alone” for audio
		AUTO	OFF/ RUN / AUDI	Runs fixture for no DMX
3	LAMP	ON/OFF		Manually switches lamp “on” and “off”
4	RESE	ALL		Reset all motors and returns fixture to home

		COLR		Reset only motors for colors	
		SHTR		Reset only motors for shutter and/or dimmer	
		OTHR		Reset other motors	
5	TIME	LIFE	0000~9999	Displays the total fixture running time	
		LAMP	0000~9999	Displays a lamps running time	
		CLMP		Clear lamp running time	
6	MIC	M-XX M-70		Mic sensitivity	
7	DISP	VALU	D-XX D-00 (DXXX)	Display the DMX512 value of each channel	
		D ON	ON/OFF	Display turn off after 2mins	
		FLIP	ON/OFF	This function will reverse the display 180	
8	SPEC	LAAU	ON/OFF	Automatic lamp start with power	
		RDMX	ON/OFF	Change DMX address via external controller	
		DLOF	ON/OFF	Switch lamp via DMX	
		DLAY	D-XX D-05	Lamp on delay time	
		SPOT	ON/OFF	Lamp optimization	
		DFSE	ON/OFF	Resets all the fixture functions to default	
		FANS	HIGH/AUTO	Fan's mode select	
		VER	V1.0~V9.9	Software version	
		ADJU	CODE CH01~CH30	CXXX XXXX(-128~127)	Fixture code *code is "C050" Motor Fix
9	EDIT	STEP	S-01 ~S-48	Set the amount of your program	
		SCXX	C-01~C-30	0 1 XX(00~FFH) 3 0 XX(00~FFH)	Edit the channels of each scene
			TIME	T XXX(001~999)	Time for each scene
			CEDT	ON/OFF	Edit program via controller
		REC.	RE.XX		Auto Save
		RUN	ON/OFF		Program test

Main Menu Functions

0. ADDRESS MENU

Addr - **A001 - A511** (Value) - This is where you set the fixtures DMX address.

Setting/Changing the DMX Address

After applying power to the CMY ZOOM 575™ the LED will display the fixture's current DMX address immediately after the reset sequence. If the fixture is not receiving a DMX signal the display will flash continuously. To set or adjust a DMX address, please follow the procedure below:

1. Switch on the CMY ZOOM 575™ and wait for the fixture reset process to finished.
2. Press the Mode/Esc button to access the main menu. Toggle through the menu by pressing the Up and Down buttons until the display shows A001. Tap the enter button to make changes to the address, the current three digit address will immediately begin to flash.
3. While the current three-digit address is flashing, use the UP and DOWN buttons to select adjust the address. Lock your new address into the unit's memory by pressing the Enter button. After the new address has been successfully stored into the fixture's memory the LED will briefly readout PASS.

The DMX address is non-destructible and will remain in the fixture's memory even when power to the fixture has been switched off. Memory is backed-up and retained by an internal power source with a five year shelf life.

1. TEST MENU

TEST - **T-01 - T-XX** (Test) - T ests the functions of each channel. There are 10 DMX channels, and all channels except channel 3, 6, and 10 can be tested. To enter the test menu follow the procedure below:

1. Access the main menu.
2. Tap the UP button until "TEST" is displayed, press ENTER.
3. The display will show T-01. You can now press the up button and test the different channels. For example: If you press the up button until "T-03" is displayed, the unit

will test the color channel, changing the color one by one and show the rainbow effect with different speeds. Again please remember, there are 10 DMX channels, and all except channels 3, 6, and 10 can be tested

4. Press MODE/ESC to exit.

2. PLAY MENU -

RUN

 – This feature is used to run the internal preset programs in either a Master/Slave or a stand-alone operating mode. Follow the procedure below to enter the run menu:

1. Access the main menu.
2. Tap the UP or DOWN button until “PLAY” is displayed, press ENTER.
3. Tap the UP or DOWN button until “RUN” is displayed, press ENTER.
4. Tap the UP or DOWN button to select either “Master” or “Alone” and press ENTER.
5. Press MODE/ESC to return to the main menu.

AUDI

 - This feature is used to run the internal preset programs in AUDIO mode in either a Master/Slave or a stand-alone operating mode Follow the procedure below to enter the audio menu:

1. Access the main menu.
2. Tap the UP or DOWN button until “PLAY” is displayed, press ENTER.
3. Tap the UP or DOWN button until “AUDI” is displayed, press ENTER.
4. Tap the UP or DOWN button to select either “Master” or “Alone” and press ENTER.
5. Press MODE/ESC to return to the main menu.

AUTO

 – Runs the unit without any DMX signal in stand-alone mode. Follow the procedure below to enter the auto menu:

1. Access the main menu.
2. Tap the UP or DOWN button until “PLAY” is displayed, press ENTER.
3. Tap the UP or DOWN button until “AUTO” is displayed, press ENTER.

4. Tap the UP or DOWN button to select “OFF”, “RUN” or “AUDI” and press ENTER to confirm.
5. Press MODE/ESC to return to the main menu.

3. LAMP MENU -

 – This menu function will manually turn the lamp on and off. Follow the procedure below to enter the lamp menu:

1. Access the main menu.
2. Tap the UP button until “LAMP” is displayed, press ENTER.
3. The display will show “ON/OFF”.
4. Press the UP button to select “ON” to activate this function, or “OFF” to deactivate this function.
5. Press ENTER to confirm.
6. Press MODE/ESC to return to the main menu.

4. RESE (RESET) MENU -



ALL - Resets all the motors in the unit.

COLR (Color) - Resets the color motors.

GOBO - Resets the gobo motors.

SHTR - Resets the shutter motors.

OTHR - Reset all other motors

ALL

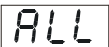
 - When you activate this reset function, the fixture will begin to reset all motors to their home position.

1. Access the main menu.
2. Tap the UP button until “RESE” is displayed, press ENTER.
3. Tap the UP button until “ALL” is displayed in the LCD then press ENTER to confirm and begin the reset process.
4. Press MODE/ESC to return to the main menu.

COLR

 - When you activate this reset function, the fixture will only reset the color wheel motor.

1. Access the main menu.
2. Tap the UP button until “RESE” is displayed, press ENTER.
3. Tap the UP button until “COLR” is displayed, then press ENTER to confirm and begin the reset process.
4. Press MODE/ESC to return to the main menu.

GOBO

- When you activate this reset function, the fixture will only reset the gobo wheel motor.

1. Access the main menu.
2. Tap the UP button until “RESE” is displayed, press ENTER.
3. Tap the UP button until “GOBO” is displayed, press ENTER to confirm and begin the reset process.
4. Press MODE/ESC to return to the main menu.

SHTR

 - When you activate this reset function, the fixture will only reset the shutter/dimmer motor.

1. Access the main menu.
2. Tap the UP button until “RESE” is displayed, press ENTER.
3. Tap the UP button until “SHTR” is displayed, then press ENTER to confirm and begin the reset process.
4. Press MODE/ESC to return to the main menu.

OTHR

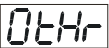
 - When you activate this reset function, the fixture will only reset any motor not specified in the previous reset commands.

1. Access the main menu.

2. Tap the UP button until “RESE” is displayed, press ENTER.
3. Tap the UP button until “OTHR” is displayed, press ENTER to confirm and begin the reset process.
4. Press MODE/ESC to return to the main menu.

5. TIME MENU -

TIME

LIFE - Displays the fixtures total running time.

LAMP - Displays the lamp running time.

CLMP - Clears the lamp running time.

LIFE

LIFE

- With this function you can display the total running time of the fixture.

1. Access the main menu.
2. Tap the UP button until “TIME” is displayed, press ENTER.
3. Tap the UP button until “LIFE” is displayed, press ENTER.
4. Press MODE/ESC to return to the main menu.

LAMP

LAMP

- With this function you can display the running time of the lamp.

1. Access the main menu.
2. Tap the UP button until “TIME” is displayed, press ENTER.
3. Tap the UP button until “LAMP” is displayed, press ENTER.
4. Press MODE/ESC to return to the main menu.

CLMP

CLMP

- With this function you can clear the running time of the lamp. **Note: Please clear the lamp time every time you replace the lamp.**

1. Access the main menu.
2. Tap the UP button until “TIME” is displayed, press ENTER.

3. Tap the UP button until “CLMP” is displayed, then press ENTER to reset the lamp running time.
4. Press MODE/ESC to return to the main menu.

6. MIC MENU

 - This function allows for electronic control of the internal microphone's sound sensitivity.

1. Access the main menu.
2. Tap the UP button until “MIC” is displayed and press ENTER.
3. The display will show “M-XX” (Where XX represents a value between 00 & 99).
4. Use the UP and DOWN button to adjust the microphone sensitivity, 99 being the highest.
5. Press ENTER to confirm and lock your new setting in place.
6. Press MODE/ESC to return to the main menu.

7. DISPLAY MENU

 - This menu function will control the various on-board display features.

 **VALU** – This function will display the DMX value of each channel as it is adjusted through the use of a DMX console.

1. Access the main menu.
2. Tap the UP button until “DISP” is displayed.
3. Press ENTER, the display will show “VALU”.
4. Press ENTER, once again “d-00” will be displayed.
5. Press ENTER to confirm.
6. Press MODE/ESC to return to the main menu.

 **D ON** – This function will turn the display of off after the unit has gone two seconds without any activity.

1. Access the main menu.

2. Tap the UP button until “DISP” is displayed.
3. Press ENTER, the display will show “VALU”.
4. Tap the UP button until ”D-ON” is displayed and tap the ENTER button.
5. Press the UP button to select “ON” to activate this function, or “OFF” to deactivate this function.
6. Press ENTER to confirm.
7. Press MODE/ESC to return to the main menu.

FLIP

FLIP – This function will reverse the display readout by 180°.

1. Access the main menu.
2. Tap the UP button until “DISP” is displayed.
3. Tap the UP button until ”FLIP” is displayed and tap the ENTER button.
4. Press the UP button to select “ON” to activate this function, or “OFF” to deactivate this function.
5. Press ENTER to confirm.
6. Press MODE/ESC to return to the main menu.

8. SPEC MENU – This menu option access all the special functions listed below.

LAAU - Automatic lamp start with power.

RDMX - Allows DMX address to be changed via and external DMX controller.

DLOF - Switch lamp off via DMX controller.

DLAY - Lamp-on delay time.

SPOT - This provides a spot beam for better lamp optimization.

DFSE (Default) - Resets the unit to all default settings.

FANS- Changes the functionality of the built-in fans.

VER (Version) - Displays the software version.

ADJU – Calibration functions

LAAU

LAAU

– This function controls the automatic lamp start feature. By default the unit will automatically ignite the lamp when unit is turned on. Use this function to turn this

feature on and off.

1. Access the main menu.
2. Tap the UP button until "SPEC" is displayed, press ENTER.
3. Tap the UP button until "LAAU" is displayed, press ENTER.
4. The display will show "ON/OFF."
5. Press the UP button to display "ON" to activate this function, or "OFF" to deactivate this function.
6. Press ENTER to confirm.
7. Press MODE/ESC to return to the main menu.

RDMX



– This function allows the DMX address to remotely be adjusted from a DMX console. This setting requires special settings for both the controller and the fixture. RDMX is on by default. Follow the procedure listed below to access the RDMX functions:

Fixture Settings:

1. Access the main menu.
2. Tap the UP button until "SPEC" is displayed, press ENTER.
3. Tap the UP button until "RDMX" is displayed, press ENTER.
4. The display will show "ON/OFF."
5. Press the UP button to display "ON" to activate this function, or "OFF" to deactivate this function.
6. Press ENTER to confirm.
7. Press MODE/ESC to return to the main menu.

Controller Settings:

1. Set the DMX value of channel 1 to a value of 7.
2. Set the DMX value of channel 2 to a value of 7 or 8. When channel 2 is set to "7" you can adjust the starting address between 1 and 255. When set to "8" you can adjust the starting address between 256 and 511.
3. Use channel 3 to set your desired DMX starting address. ***For example:*** If you want to set the starting address to 57, set channel 1 to a value of "7," set channel

2 to a value of “7” and use channel 3 to set your address to 57 by selecting a channel value of 57. Example 2: If you want to set the starting address to 420, set channel 1 to a value of “7,” channel 2 to “8” and channel 3 to “164” (256+164=420).

4. ***Wait for approximately 20 seconds for the unit to complete the address reset function.***

DLOF

dLOF

– This feature allows you to control the lamp via DMX.

1. Access the main menu.
2. Tap the UP button until “SPEC” is displayed, press ENTER.
3. Tap the UP button until “DLOF” is displayed, press ENTER.
4. The display will show “ON/OFF.”
5. Press the UP button to display “ON” to activate this function, or “OFF” to deactivate this function.
6. Press ENTER to confirm.
7. Press MODE/ESC to return to the main menu.

DLAY

dLAY

– This function allows the user to set a lamp “strike” delay time.

1. Access the main menu.
2. Tap the UP button until “SPEC” is displayed, press ENTER.
3. Tap the UP button until “DLAY” is displayed, press ENTER.
4. The display will show “D-XX.”
5. Press the UP and DOWN buttons to adjust the delay time.
6. When completed press ENTER to confirm.
7. Press MODE/ESC to return to the main menu.

SPOT

SPOE

– This function allows you to optimize the lamp without the use of an external DMX controller. In this mode, the device will not react to any control signal.

1. Access the main menu.
2. Tap the UP button until “SPEC” is displayed, press ENTER.
3. Tap the UP button until “DFSE” is displayed, press ENTER.
4. The display will show “ON/OFF.”
5. Press the UP button to display “ON” to activate this function, or “OFF” to deactivate this function.
6. Press ENTER to confirm.
7. Press MODE/ESC to return to the main menu.

DFSE

 - With this function you can restore the factory settings of the device. All settings will be set back to the default values. Any edited scenes will be lost. When restoring the factory settings the unit must be set to the address that the unit was in when you started editing. ***When you confirm this function, the fixture will begin to reload the original factory settings.***

1. Access the main menu.
2. Tap the UP button until “SPEC” is displayed, press ENTER.
3. Tap the UP button until “DFSE” is displayed, press ENTER.
4. The display will show “ON/OFF.”
5. Press the UP button to display “ON” to activate this function, or “OFF” to deactivate this function.
6. Press ENTER to confirm.
7. Press MODE/ESC to return to the main menu.

FANS

 - This function is used to change the functionality of the internal cooling fans.

Follow the procedure below to access the fan menu:

1. Access the main menu.
2. Tap the UP or DOWN button until “SPEC” is displayed, press ENTER.
3. Tap the UP or DOWN button until “FANS” is displayed, press ENTER.
4. The display will show “HIGH/AUTO”.

5. Press UP or DOWN button to select “HIGH” or “AUTO”.
6. Press ENTER to confirm.
7. Press MODE/ESC to return to the main menu.

VER

 - Use this function to display the Software version of the unit.

1. Access the main menu.
2. Tap the UP button until “SPEC” is displayed, press ENTER.
3. Tap the UP button until “VER” is displayed, press ENTER.
4. The display will show “V-1.0,” the display may also show, “V-2.0,” “V-9.9” etc.
5. Press ENTER or MODE/ESC to exit.

ADJU

 - This function is used to calibrate the various internal motors in the event the internal homing mechanism become slightly out of adjustment. This function is protected with a password to prevent unauthorized personal from tampering with the fixture. To enter the calibration menu follow the steps below:

1. Access the main menu.
2. Tap the UP or DOWN buttons until “ADJU” is displayed, then press ENTER.
3. Tap the UP or DOWN buttons until “CODE” is displayed, then press ENTER.
4. The display will show “CXXX”, were as XXX represents the calibration password. The calibration password is “C050.” Use the UP or DOWN buttons to enter the proper password.
5. Once the proper password is entered the display will read “CHXX”, were as “XX” represents the fixture channel number, in the case of the CMY Zoom 575™ 1 ~ 10.
6. Select the desired channel to be calibrated by pressing the UP or DOWN buttons and then ENTER to confirm.
7. The display will then read “xxxx”, were “xxxx” stands for the calibrate values.
8. Adjust the desired calibration value between –128 and 127 by pressing the UP and DOWN. As you scroll up and down through the calibration values you will notice slight changes in the wheel or motor you are attempting to calibrate.

9. Once you reach your desired calibration press ENTER to confirm and lock in your calibration.

9. EDIT MENU

Ed It - This menu item allows you to write a program into the fixture's memory (EEPROM) via the control panel or via an external DMX controller.

STEP (S-01 - S-48) - These are the steps slots that you write your programs into. There are a total of 48 steps.

SCXX (SC01 – SC48) - These are the scenes that are stored in your program. There are a total of 48 scenes. C-01 - C-10 (Channel 1 - Channel 10) – Represents the total fixture channels for each scene that can be edited.

TIME (Time) - Running time of the entire program.

CEDT - Edit program using an external controller.

REC – Auto save function.

RUN – Program test mode.

REC

- Records scenes automatically from any external DMX controller and stores them inside the fixtures built-in memory. These scenes can then be recalled without the use of an external controller.

1. Access the main menu.
2. Tap the UP or DOWN buttons until "EDIT" is displayed, then press ENTER.
3. Tap the UP or DOWN buttons until "REC" is displayed, then press ENTER.
4. After entering the REC function the display will read "RE.XX," where as "XX" represents the scene number in the internal memory to which the scene will be stored.
5. Press the UP or DOWN buttons to select the desired scene number.
6. When you reach the scene number you wish to store the scene to, press ENTER to confirm and lock the scene into the fixture's memory.
7. Press MODE/ESC to return to the main menu.

STEP**STEP**

- With this function you can program the number of steps in your individual Program.

1. Access the main menu.
2. Tap the UP button until “EDIT” is displayed, press ENTER.
3. Tap the UP button until “STEP” is displayed, press ENTER.
4. The display shows “S-01”, this indicates the first step of your program. You can call up to 48 scenes in “Run.” For example; if “S-05” is displayed, it means that the scene will “RUN” the first 5 scenes you saved in “Edit.”
5. Press ENTER to save and MODE/ESC to exit.

SC01**SC01**

- This function allows you to choose the total number of scenes in your internal program.

1. Access the main menu.
2. Tap the UP button until “EDIT” is displayed, press ENTER.
3. Tap the UP button until “SC01” is displayed.
4. The display indicates “SC01,” this stands for the first scene of your program. You may recall up to 48 scenes. For example, if you choose “SC05,” and then select the “Run” function, the first 5 scenes you saved in “Edit” mode will run.
5. Press ENTER to save and MODE/ESC to exit.

Editing procedure 1: Using the control board only.

1. Access the main menu.
2. Tap the UP button until “EDIT” is displayed and press ENTER.
3. The display will show “SC-01”, this stands for the scene number. For example, “SC-01” is displayed, it means you will be editing scene 1, press ENTER. You can change the scene number by tapping the UP button.
4. Press ENTER, the display will show “C-01,” this represents the channel number. If “C-01” is displayed, you will be editing the fixture’s channel 1 value of the selected scene, press ENTER. You can change the channel number by tapping the UP button.

5. The display will show the DMX value for the channel that is being edited. It will be displayed as "07XX," it stands for Channel 7 of the editing scene, the DMX value is "XX."
6. Adjust the DMX value by tapping the UP button, until you get the expected effect for this channel.
7. Press ENTER to enter the editing of the other channels of the scene.
8. Repeat steps 5-8, until you finish setting all the DMX values for all the channels of this scene, each scene can have 7 channels maximum.
9. Once all the channels are completed, the display will begin to flash "TIME," this indicates the time needed to run this scene.
10. Press ENTER to edit the time needed, the display shows "TXXX", "XXX" represents the time needed to run this scene. For example, "T002" means scene 1 needs 0.4 seconds to run, "T-15" means this scene needs 3.0 seconds to run. Note: "XX" is always 0.2 seconds not one second.
11. Adjust the time needed by tapping the UP button.
12. Press ENTER to save the settings for the scene you are editing, the display will change to the next scene automatically.
13. Repeat steps 3-12 to edit other scenes, you can edit and save 48 scenes maximum.
14. Press MODE/ESC to exit and save your edited scene into the fixtures internal memory. The number of steps can be defined under "EDIT" and the scenes can be called up under "Run." To run the scenes see page 25.

Editing procedure 2: Using an external controller.

1. Call up the first scene in your controller now.
2. Select "SC01" by pressing the UP or DOWN buttons.
3. Press MODE/ESC, the display shows "SC01".
4. Press MODE/ESC, the display shows "C-01".
5. Select "**CEDT**" by pressing the UP or DOWN buttons.
6. Press MODE/ESC, the display shows "OFF".
7. Press UP, the display will read "ON".
8. Press MODE/ESC, the display shows "SC02". You successfully downloaded

the first scene.

9. Adjust the Step-time as described above.
10. Call up the second scene in your controller now.
11. Repeat steps 5-11 until all desired scenes are downloaded.
- 12.** Press MODE/ESC to exit. The number of steps can be defined under “STEP” and the scenes can be called up under “RUN.”

RUN

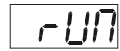

- With the function “RUN”, you can run your pre-made program. You can set the number of steps under Step (S-01- S-48). You can edit the individual scenes under Edit.

1. Access the main menu.
2. Tap the UP button until “EDIT” is displayed, press ENTER.
3. Tap the UP button until “RUN” is displayed, press ENTER.
4. The display will then read either ON or OFF.
5. Use the UP button to toggle between the “ON” and “OFF” commands.
6. Select a mode, and press ENTER to confirm.
- 7.** Press MODE/ESC to return to the main menu.

10. DMX CHANNEL TRAITS

The chart below details the channel layout for 11 DMX channels.



%	1 Color	2 C	3 M	4 Y	5 Strobe	6 Dimming	7 E ffect wheel	8 ZOOM	9 Colour And CMY Macro	10 CMY and dimmer speed	11 Auto Program
100%											
75%											
50%											
25%											
0%											

CHANNEL 1: Color Wheel

CHANNEL 2: Cyan Filter

CHANNEL 3: Magenta Filter

CHANNEL 4: Yellow Filter

CHANNEL 5: Strobe Control

CHANNEL 6: Mechanical Dimmer

CHANNEL 7: Effect Wheel (Beam Shape, Frost Filter)

CHANNEL 8: Zoom (7° ~ 28°)

CHANNEL 9: Macros

CHANNEL 10: Speed Control

CHANNEL 11: Special Functions

DMX channel function and values:**Channel 1 - Color Wheel:**

- 0-15 Open / white
- 16-31 Red
- 32-47 Blue
- 48-63 Green
- 64-79 Light Yellow
- 80-95 UV filter
- 96-111 CTB
- 112-127 CTO
- 128-189 Forwards rainbow effect from fast to slow
- 190-191 No rotation
- 192-255 Backwards rainbow effect from slow to fast

Channel 2 - Cyan Color Wheel:

- 0-255 Cyan (0-white, 255-100% Cyan)

Channel 3 - Magenta Color Wheel:

- 0-255 Magenta (0-white, 255-100% magenta)

Channel 4 - Yellow Color Wheel:

- 0-255 Yellow (0-white, 255-100% Yellow)

Channel 5 - Shutter, strobe:

- 0-31 Shutter closed
- 32-63 No function (shutter open)
- 64-95 Strobe effect slow to fast
- 96-127 No function (shutter open)
- 128-159 Pulse effect in sequences
- 160-191 No function (shutter open)
- 192-223 Random strobe effect slow to fast
- 224-255 No function (shutter open)

Channel 6 – Dimmer intensity:

- 0-255 Gradual adjustment of the dimmer intensity from 0-100%

Channel 7 - Effect wheel:

- 0-70 Full beam
- 71-230 Beam shaper
- 231-255 Frost filter

Channel 8 - Zoom:

0-255 Zoom 27 - Zoom 19

Channel 9 - Color macros - CMY and color wheel

0-7 Off

8-15 Macro1

16-23 Macro2

24-31 Macro3

32-39 Macro4

40-47 Macro5

48-55 Macro6

56-63 Macro7

64-71 Macro8

72-79 Macro9

80-87 Macro10

88-95 Macro11

96-103 Macro12

104-111 Macro13

112-119 Macro14

120-127 Macro15

128-135 Macro 16

136-143 Macro 17

144-151 Macro 18

152-159 Macro 19

160-167 Macro 20

168-175 Macro 21

176-183 Macro 22

184-191 Macro 23

192-199 Macro 24

200-207 Macro 25

208-215 Macro 26

216-223 Macro 27

224-231 Macro 28

232-239 Macro 29

240-247 Macro 30

248-255 Random CMY Color Mixing

Channel 10 - Speed Of CMY And Dimmer :0-225 Speed Max $_ >$ Min

226-235 No function

236-245 Max speed and black out by while color change

246-255 No function

Channel 11 – Lamp on/off, reset, internal programms

- 0-19 Color change normal
- 20-39 Color change to any position
- 40-59 Lamp on
- 60-79 Lamp switch off
- 80-84 All motor reset
- 85-87 No function
- 88-90 Colors motor reset
- 91-93 No function
- 94-96 Shutter & Dimmer motor reset
- 97-99 Other motor reset
- 100-119 Internal program 1
- 120-139 Internal program 2
- 140-159 Internal program 3
- 160-179 Internal program 4
- 180-199 Internal program 5
- 200-219 Internal program 6
- 220-239 Internal program 7
- 240-255 Auto program by music

11. ERROR CODES:

When power is applied, the unit will automatically enter a “reset/test” mode. This mode brings all the internal motors to a home position. If there is an internal problem with one or more of the motors an error code will flash in the display in the form of “XXEr” where XX will represent a function number. For example, when the display shows “02Er,” it means there is some type of error with the channel 2 motor. If there are multiple errors during the start-up process they will all flash in the display. For example: if the fixtures has errors on channel 1, channel 2, and channel 5 all at the same time, you will see the error message “01Er”, “02Er,” and “05Er” flash repeated 5 times.

If an error does occur during the initial start-up procedure the fixture will self-generate a second reset signal and try to realign all the motors and correct the errors, if the error persists after a second attempt a third attempt will be made.

If after a third attempt all the errors have not been corrected the fixture will make the following determinations: 1) 3 or more errors - The fixture cannot function properly with three or more errors therefore the fixture will place itself in a stand-by mode until subsequent repairs can be made. 2) Less than 3 errors - The fixture has less than 3 errors, therefore most other functions will work properly. The fixture will attempt to operate normally until the errors can be corrected by a technician. The errors in question will remain flashing in the display as a reminder of internal errors.

01Er - Color-wheel error:

The color wheel is not located in the default position after start-up or after a reset command. This message will appear after a fixture reset if the color wheel’s magnetic-indexing circuit malfunctions (sensor failed or magnet is missing) or there is a stepper motor failure (defective motor or a defective motor IC drive on the main PCB).

07Er - Focus-error

This message will appear after the reset of the fixture and if the magnetic indexing circuit malfunctions (sensor failed or magnet missing) or the stepping-motor is defective (or its driver circuit on the main PCB). The focus motor is not located in the default position after

the reset.

12. CLEANING AND MAINTENANCE

The following points have to be considered during the inspection:

1. Be sure all screws and fasteners are securely tightened at all times. Lose screws may fall out during normal operation resulting in damage or injury as larger parts could fall.
2. There must not be any deformations on the housing, color lenses, rigging hardware and rigging points (ceiling, suspension, trussing). Deformations in the housing could allow for UV radiation leakage. Damaged rigging points or unsecured rigging could cause the unit to fall and serious injure a person.
3. All mechanical parts and motors should not show any traces of serious wear and should rotate freely.
4. Electric power supply cables must not show any damage, material fatigue or sediments. Never remove the ground prong from the power cable.

Further instructions depending on the installation spot and usage have to be adhered by a skilled installer and any safety problems have to be removed.



CAUTION!

Disconnect from mains before starting maintenance operation.

We recommend a frequent cleaning of the device. Please use a moist, lint- free cloth. Never use alcohol or solvents.

There are no user serviceable parts inside this fixture with the exception of the lamp. Please refer all other service issues to an authorized Elation service technician.

Should you need any spare parts, please order genuine parts from your local dealer.

13. 2-YEAR LIMITED WARRANTY

A. Elation Professional® hereby warrants, to the original purchaser, Elation Professional® products to be free of manufacturing defects in material and workmanship for a period of two years, (730 days) from the date of purchase. This warranty shall be valid only if the product is purchased within the United States of America, including possessions and territories. It is the owner's responsibility to establish the date and place of purchase by acceptable evidence, at the time service is sought.

B. For warranty service, send the product only to the Elation Professional® factory. All shipping charges must be pre-paid. If the requested repairs or service (including parts replacement) are within the terms of this warranty, Elation Professional® will pay return shipping charges only to a designated point within the United States. If the entire instrument is sent, it must be shipped in its original package. No accessories should be shipped with the product. If any accessories are shipped with the product, Elation Professional® shall have no liability what so ever for loss of or damage to any such accessories, nor for the safe return thereof.

C. This warranty is void if the serial number has been altered or removed; if the product is modified in any manner which Elation Professional® concludes, after inspection, affects the reliability of the product; if the product has been repaired or serviced by anyone other than the Elation Professional® factory unless prior written authorization was issued to purchaser by Elation Professional®; if the product is damaged because not properly maintained as set forth in the instruction manual.

D. This is not a service contract, and this warranty does not include maintenance, cleaning or periodic check-up. During the period specified above, Elation Professional® will replace defective parts at its expense, and will absorb all expenses for warranty service and repair labor by reason of defects in material or workmanship. The sole responsibility of Elation Professional® under this warranty shall be limited to the repair of the product, or replacement thereof, including parts, at the sole discretion of Elation Professional®. All products covered by this warranty were manufactured after January 1, 1990, and bare

identifying marks to that effect.

E. Elation Professional® reserves the right to make changes in design and/or improvements upon its products without any obligation to include these changes in any products theretofore manufactured.

F. No warranty, whether expressed or implied, is given or made with respect to any accessory supplied with products described above. Except to the extent prohibited by applicable law, all implied warranties made by Elation Professional® in connection with this product, including warranties of merchantability or fitness, are limited in duration to the warranty period set forth above. And no warranties, whether expressed or implied, including warranties of merchantability or fitness, shall apply to this product after said period has expired. The consumer's and or Dealer's sole remedy shall be such repair or replacement as is expressly provided above; and under no circumstances shall Elation Professional® be liable for any loss or damage, direct or consequential, arising out of the use of, or inability to use, this product.

G. This warranty is the only written warranty applicable to Elation Professional® Products and supersedes all prior warranties and written descriptions of warranty terms and conditions heretofore published.

14. PHOTOMETRIC DATA

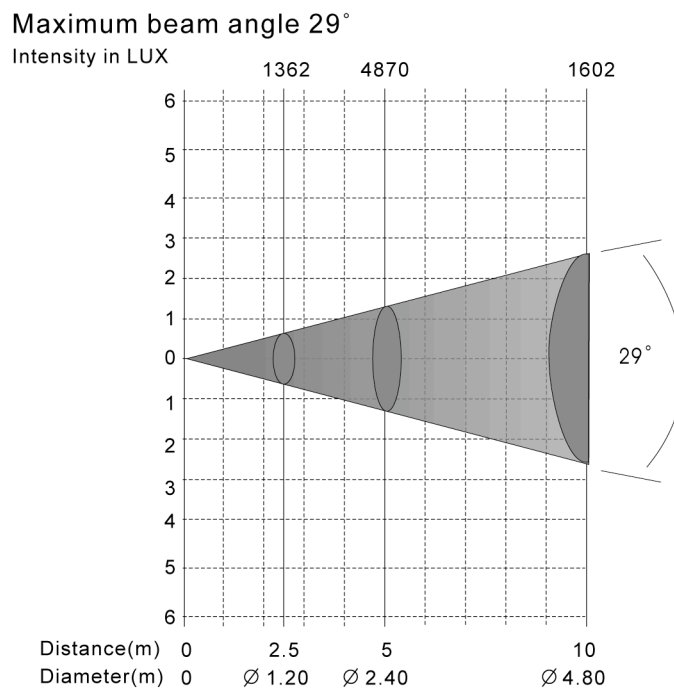
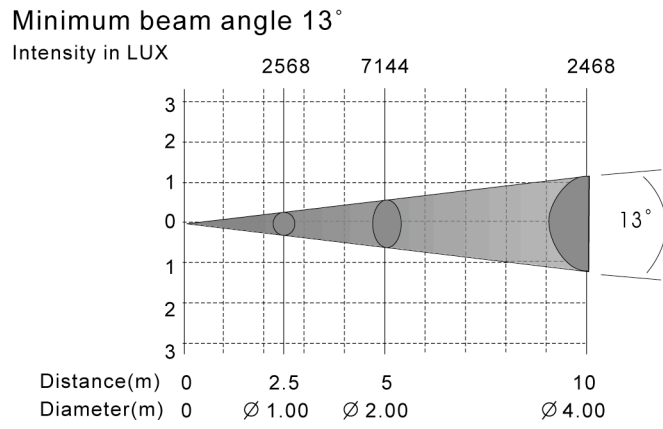

15. DIMENSIONAL DRAWINGS

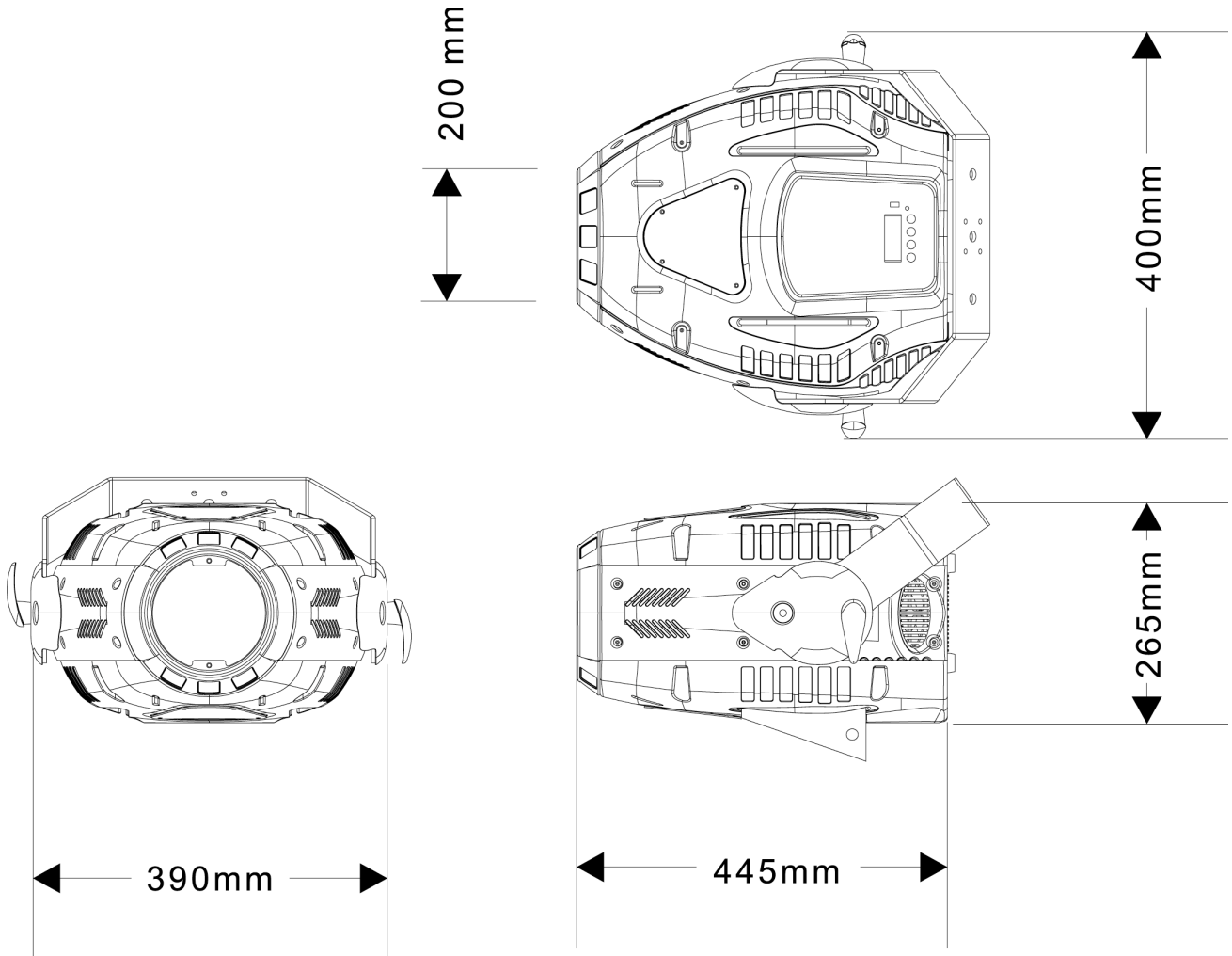

16. CIRCUIT SCHEMATIC

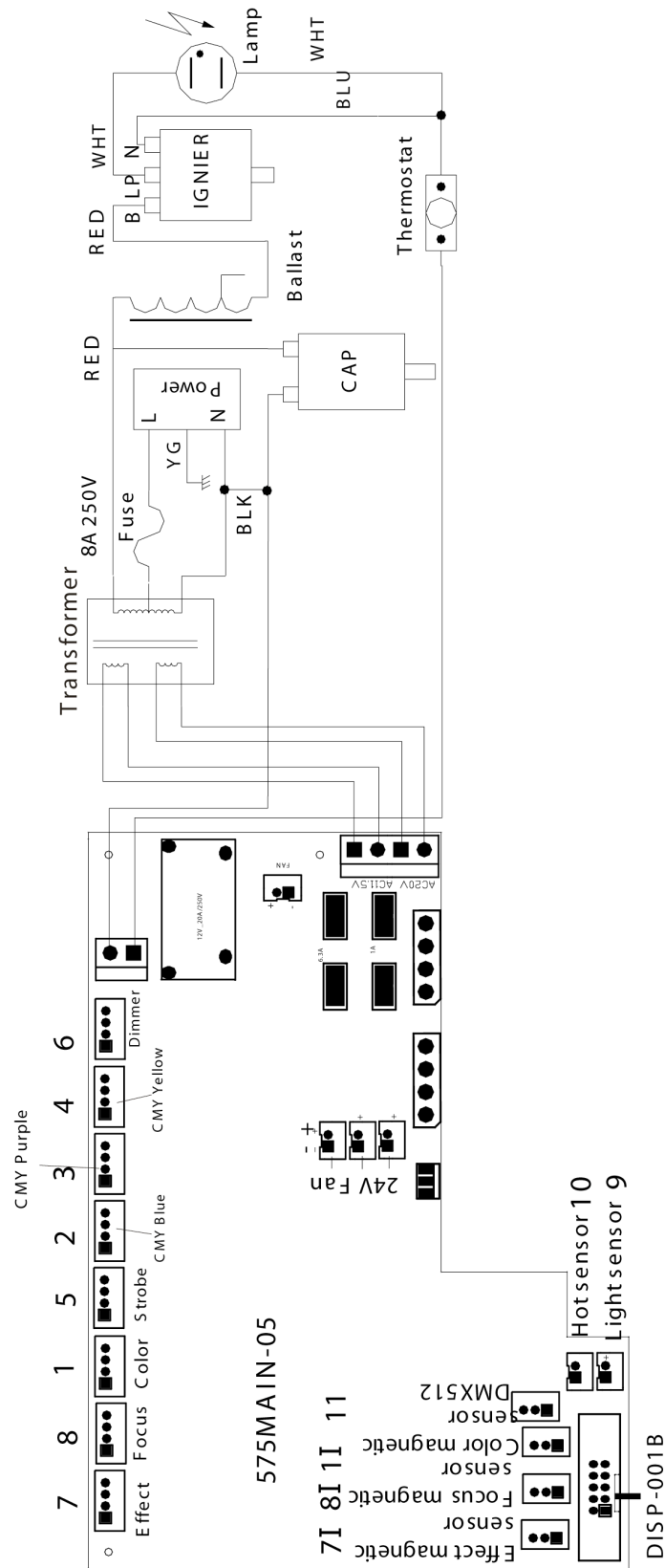

18. TECHNICAL SPECIFICATIONS

Power supply:	
Operating Voltage	_98VAC, 50Hz;_ 120VAC, 50Hz;_208VAC, 50Hz;_ 220VAC, 50Hz;_230VAC, 50Hz;_240VAC, 50Hz; or _98VAC,60Hz;_120VAC,60Hz;_208VAC,60Hz;_ 220VAC,60Hz;_230VAC,60Hz;_240VAC,60Hz;
Fuse protection	120V = 6A/250V, GMA (5x20mm fine-wire fuse) 220V = 3A/250V, GMA (5x20mm fine-wire fuse)
Power consumption	800w nominal
Lamp:	
Type	MSR 575/2 (Phillips)
Life time	1000 Hrs
Color temperature	7200° K
Luminous flux	49.000 Lm
Optical system:	
Parabolic glass reflector	
150mm Fresnel Lens	
Lens anti-reflex	
Motorized Zoom (7° ~ 28°)	
Color:	
10 Dichroic filters (7 color filters, UV Filter, CTB 64K Filter, CTC 32K Filter), plus white, half-color compatible	
Color Mixing:	
Subtractive Color Mixing with CMY Dichroic Flags	
Shutter / Strobe / Dimmer:	
Strobe-effect with variable speed 1 - 10 flashes per second	
Continuously mechanical dimmer 0 - 100%	
Focus:	
Motor driven focus from near to far away	
DMX Channels:	
11	
Drive:	
Standard DMX-512, 3 pole XLR; [+] = Pin 3 [-] = Pin 2 [Ground] = Pin 1. Starting DMX [001].	
Weights and measures:	
Dimensions	48cm (W) x 58cm (L) x 45cm (H) ~ Packing Dimensions 26.5cm (H) x 40cm (W) x 44.5cm (D) ~ Unit Dimensions (Vertical)
Weight (net)	29.5Kgs / 65Lbs

Please Note: Specifications and improvements in the design of this unit and this manual are subject to change without any prior written notice.

Elation Professional
4295 Charter Street
Los Angeles, CA. 90058
323-582-3322 / 323-582-3108 fax
www.ElationLighting.com / Info@ElationLighting.com