

DESCRIPTION

The 642 Quarter Sphere Wall Sconce features indirect illumination and is offered in two profiles. The 642/4 is ADA compliant.

Catalog #		Type
Project		
Comments		Date
Prepared by		

SPECIFICATION FEATURES

Material

Painted or plated cold-rolled steel base metal. Hexcel louver, painted black or white aluminum.

Finish

Standard: Matte White (MW) or Matte Black (MB).
Premium: Satin Chrome (SC), Polished Chrome (PC), Satin Brass (SB), Laquered Satin Aluminum (SAL), Oxidized Brass (OBRS), (NA) Natural Aluminum, (SAL) Laquered Satin Aluminum, Polished Brass (PB), Laquered Satin Chrome (SCL) and Laquered Satin Nickel (SNL) finishes only.

Optics

Refer to www.shaperlighting.com for complete photometrics.

Ballast

Integral electronic HPF, multi-volt 120/277V (347V Canada), thermally protected with end-of-life circuitry to accommodate the specified lamp wattage.

Lamp/Socket

642: One (1) 26W or 32W (GX24q-3) 4-pin triple CFL lamp or one (1) 100W A-19 lamp.
642/4: One (1) 13W (2GX7) 4-pin low wattage CFL lamp, one (1) 26W (G24q-3) quad CFL lamp or one 100W A-19 lamp CFL socket injection molded plastic. INC socket fired ceramic rated for 660W-250V. Lamps furnished by others.

Installation

Supplied with a universal circular strap for a standard 4" J-box or plaster ring.

Options

White Hexcel Louver (WHL), Black Hexcel Louver (BHL), Accent Balls (ACB), Decorative Finial (DF), Trim Ring (TR), Remote Emergency Battery (642 only) - Supplied by others (REM), MRI Applications (INC only) - Contact factory, Damp Location (DL): All Painted Finishes, Laquered Satin Chrome (SCL) and Laquered Satin Nickel (SNL) finishes only. Energy Star Rating

- Consult factory. MRI Applications (INC only) - Contact Factory.

Labels

U.L. and C.U.L approved for indoor and damp location. See options for damp location finishing requirements. 642/4 is ADA compliant.

Modifications

Shaper's skilled craftspeople with their depth of experience offer the designer the flexibility to modify standard wall luminaires for project specific solutions. Contact the factory regarding scale options, unique finishes, mounting, additional materials/colors, or decorative detailing.

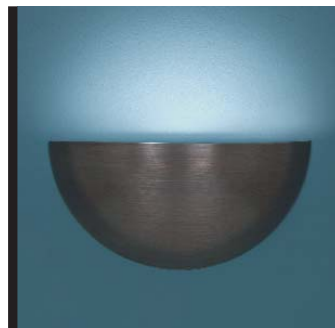

**642 SERIES
642/4 SERIES**

Interior Wall Luminaire
Indirect
Quarter Sphere



ADA AMERICAN DISABILITIES ACT (ADA)

Shaper offers a large selection of ADA interior and exterior wall luminaires. ADA requires all fixtures below 68" to have a maximum projection of 4".

SUSTAINABLE DESIGN

Shaper has a long-standing history of offering environmentally-friendly fixtures. The copper and bronze alloys used in our exterior luminaires feature up to 98% recycled content, contribute less undesirable air emissions compared to painted aluminum and are easy to recycle.

MRI MAGNETIC RESONANCE IMAGING (MRI)

Lighting fixtures for MRI facilities are specialized and unique, requiring non-ferrous construction. Fluorescent fixtures cannot be used due to the ferrous parts in ballasts and lampholders. Modified incandescent fixtures meet the requirements.

ENERGY STAR

Shaper now offers a wide variety of fixtures that can be provided with an Energy Star Rating.

QUICK SHIP (QS)

Shaper's Quick Ship program features over thirty-four fixtures with finish options such as Satin Chrome, Natural Aluminum and Satin Brass and a wide variety of lamp selections. All products ship in five days from receipt of order.

ORDERING INFORMATION

Sample Number: 642-CFL/1/26-277V-PC

Series 642 = Wall Sconce 642/4 = ADA Compliant Wall Sconce	Lamp CFL/1/13 ¹ CFL/1/26 CFL/1/32 INC/1/100	Voltage 120V 277V ² 347V ²	Finish <u>Standard</u> MB = Matte Black MW = Matte White <u>Premium</u> CC = Custom Color OBRS = Oxidized Brass PB = Polished Brass PC = Polished Chrome SAL = Laquered Satin Aluminum SB = Satin Brass SC = Satin Chrome SCL = Laquered Satin Chrome	Options TR = Trim Ring ACB = Accent Balls DL = Damp Location REM = Remote Emergency Battery ^{3, 4} DF = Decorative Finial BHL = Black Hexcel Top Louver WHL = White Hexcel Top Louver
---	---	--	--	--

Notes:

- Available with 642/4 Series.
- Available with CFL only.
- Supplied by others.
- Available with 642 Series.

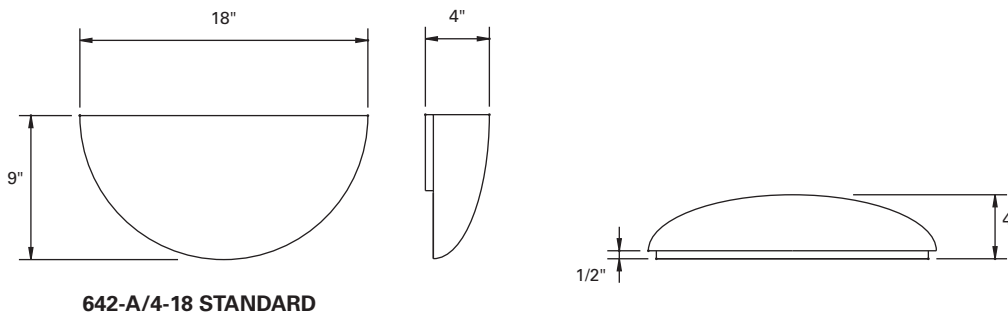
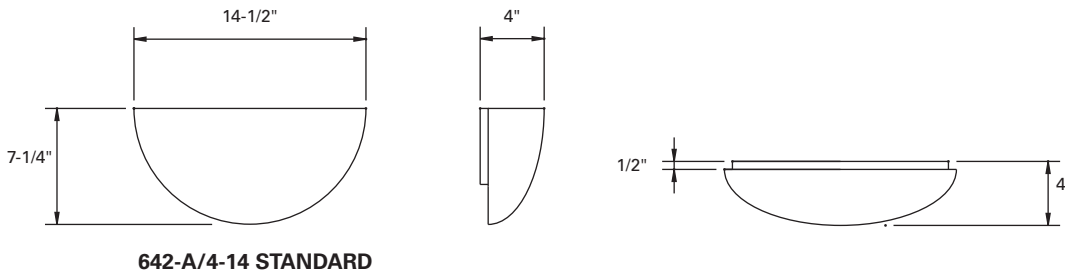
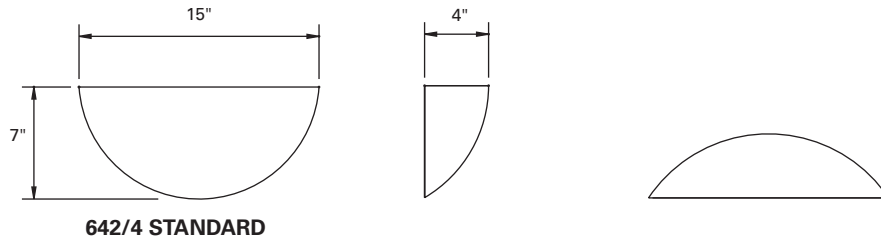
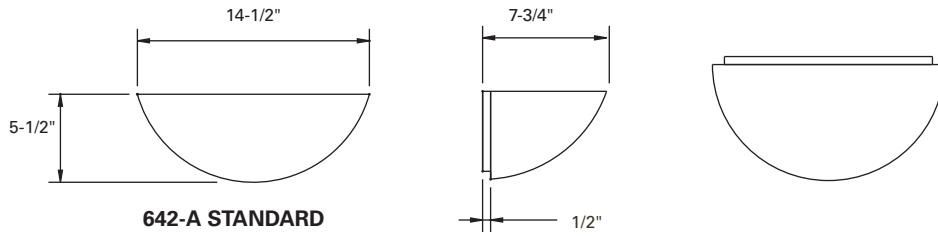
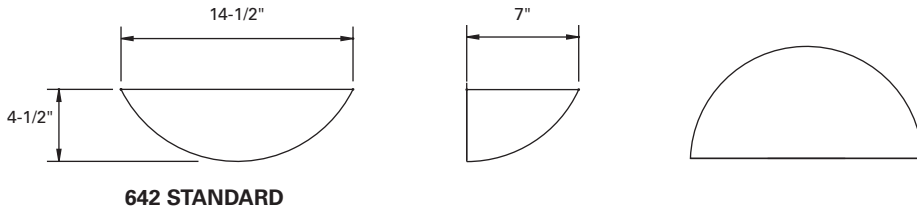

642 & 642/4 TRIM OPTIONS

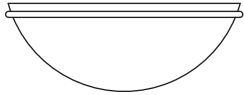

TRIM RING (TR)

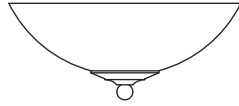

DECORATIVE FINIAL (DF)

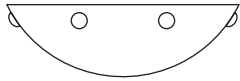

ACCENT BALLS (ACB)

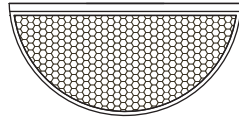

HEXCEL LOUVER WHITE (WHL) OR BLACK (BHL)