

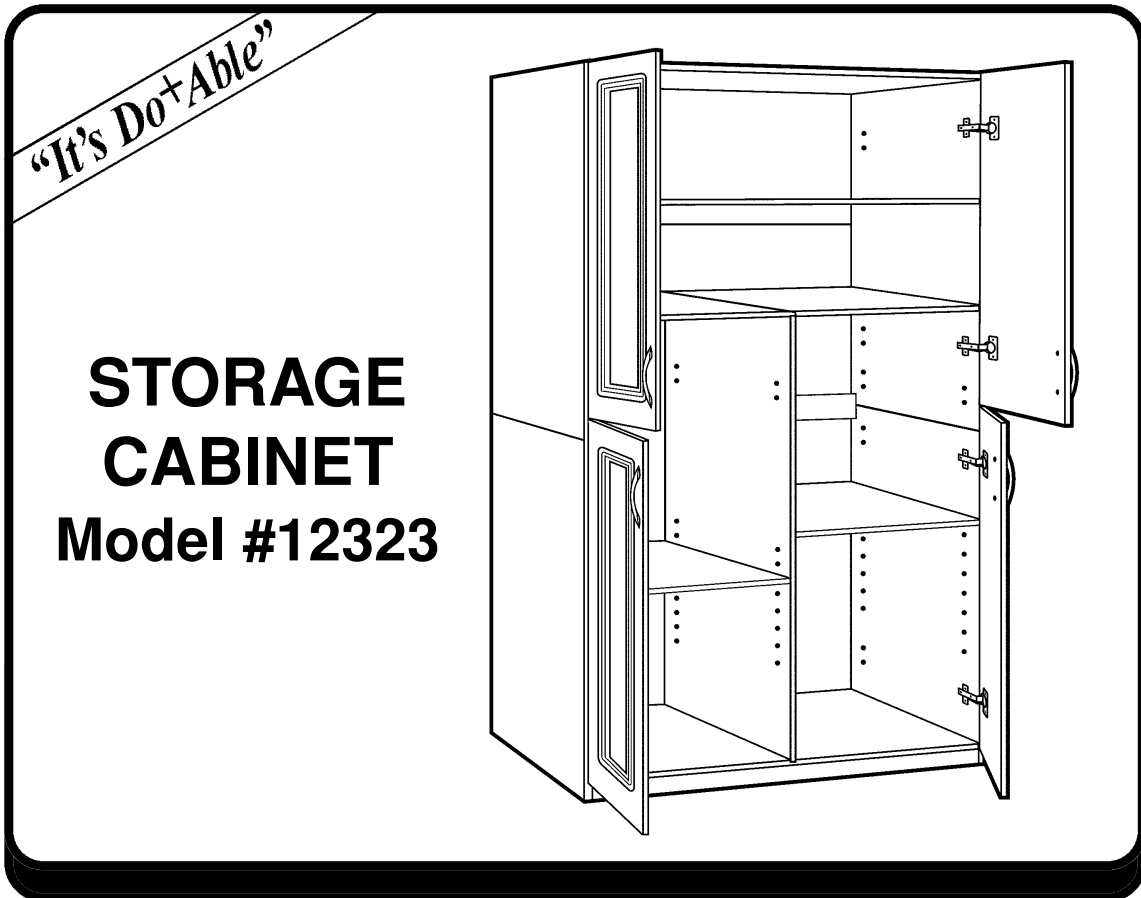

**ASSEMBLY INSTRUCTIONS
INSTRUCCIONES PARA ENSAMBLAR
DIRECTIVES D'ASSEMBLAGE**



**STORAGE
CABINET
Model #12323**

**5150 EDISON AVENUE • CHINO, CALIFORNIA 91710-5717
CUSTOMER SERVICE: (800) 829-3648
7 am to 5 pm M-F Pacific Time**

PARTS LIST / LISTA DE PIEZAS / LISTE DE PIECES

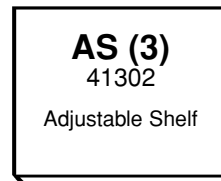
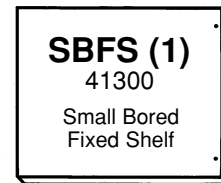
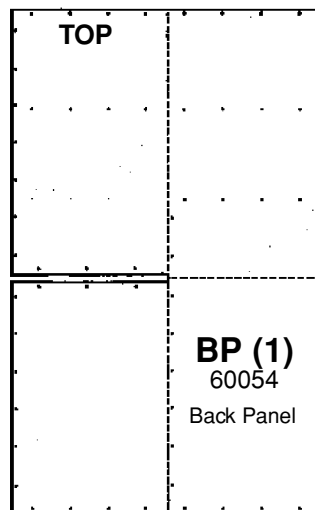
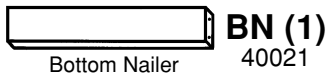
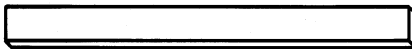
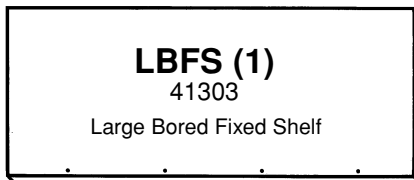
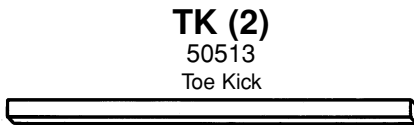
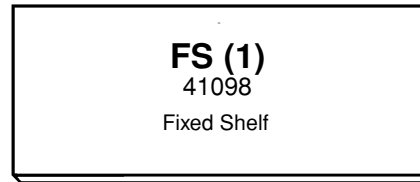
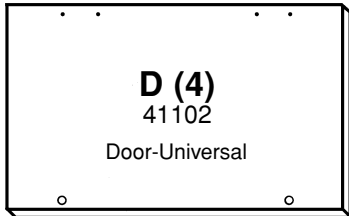
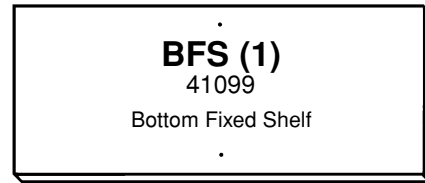
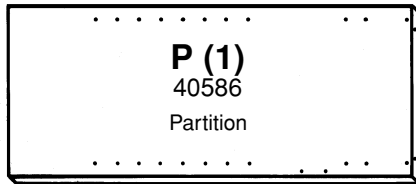
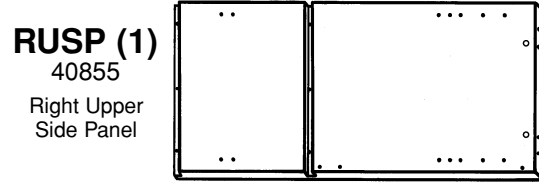
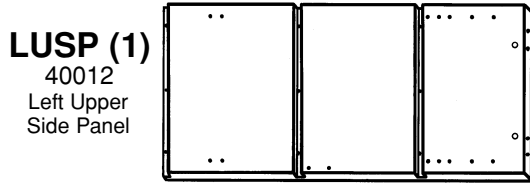
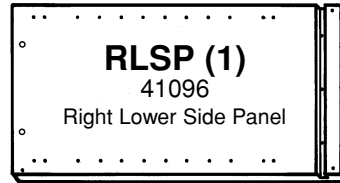
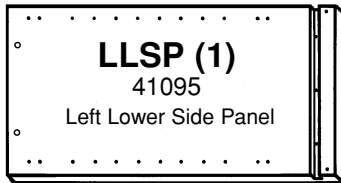

PARTS LIST / LISTA DE PIEZAS / LISTE DE PIECES

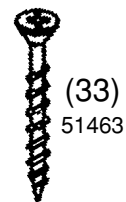
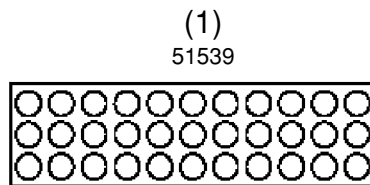
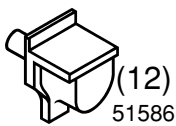
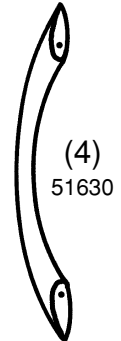
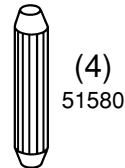
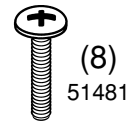
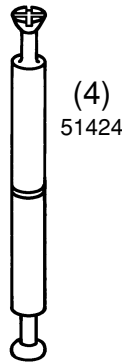
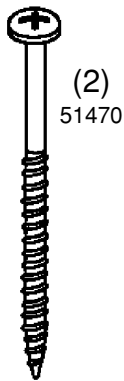
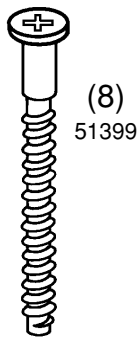
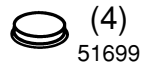
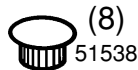
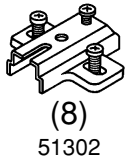
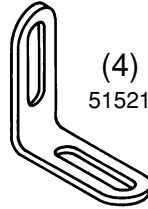
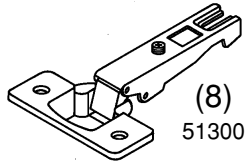
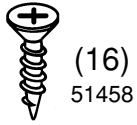

TOOLS / HERRAMIENTAS / OUTILS

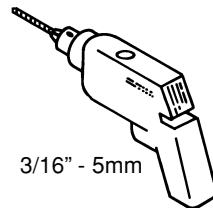
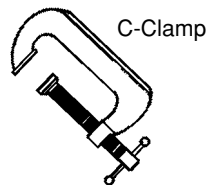
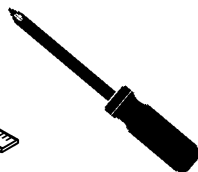
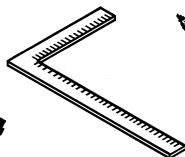
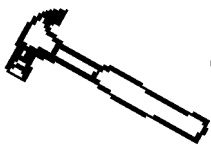

1

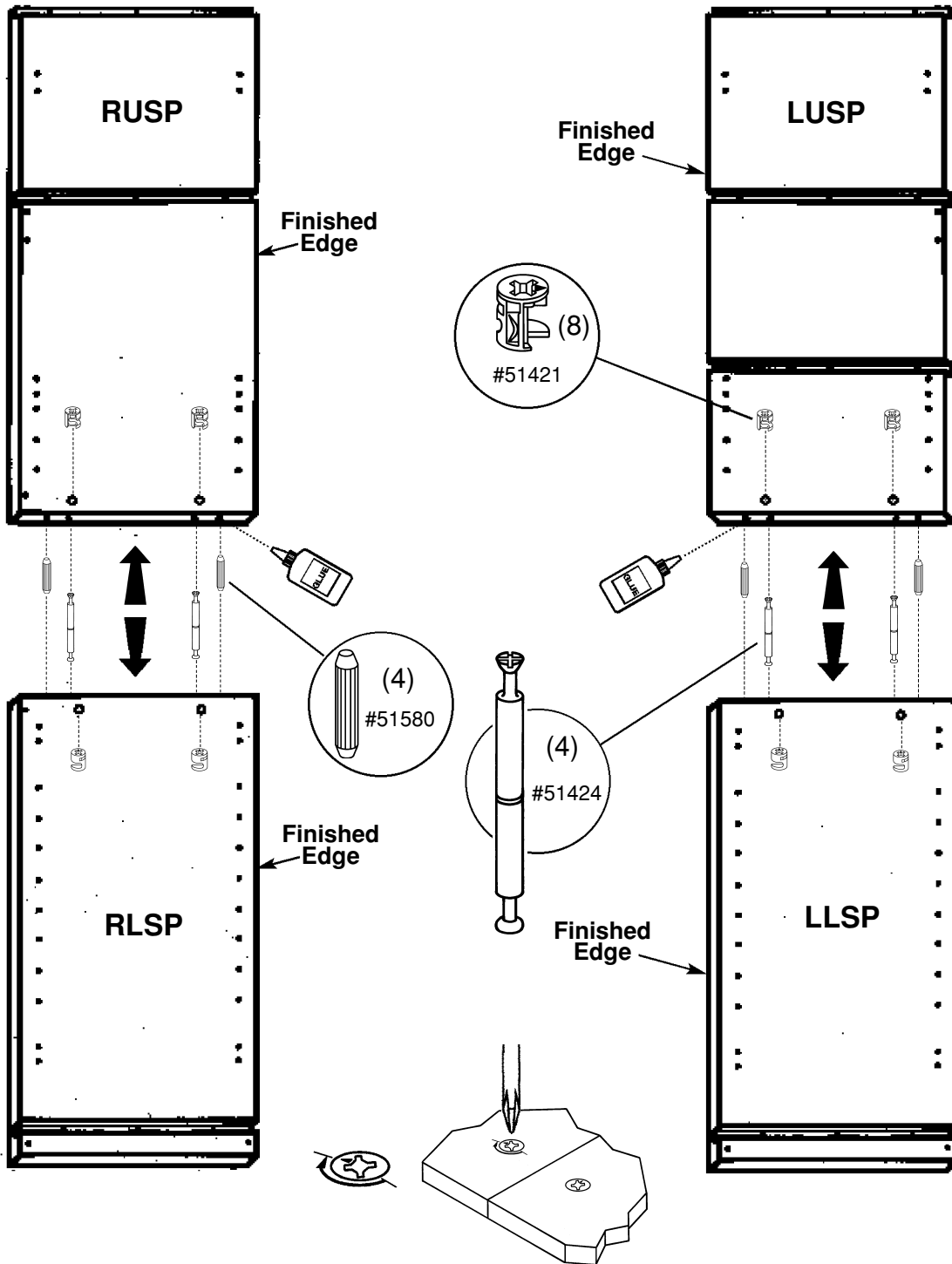

2

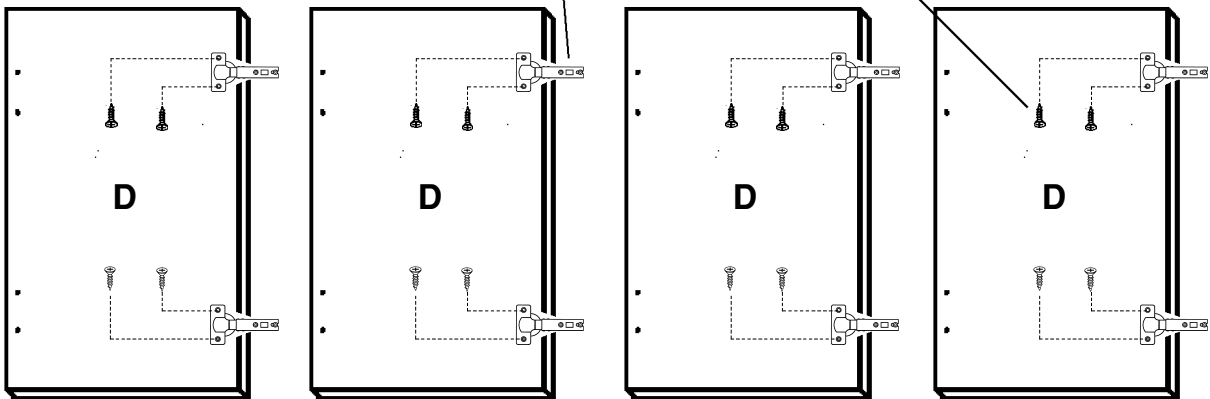
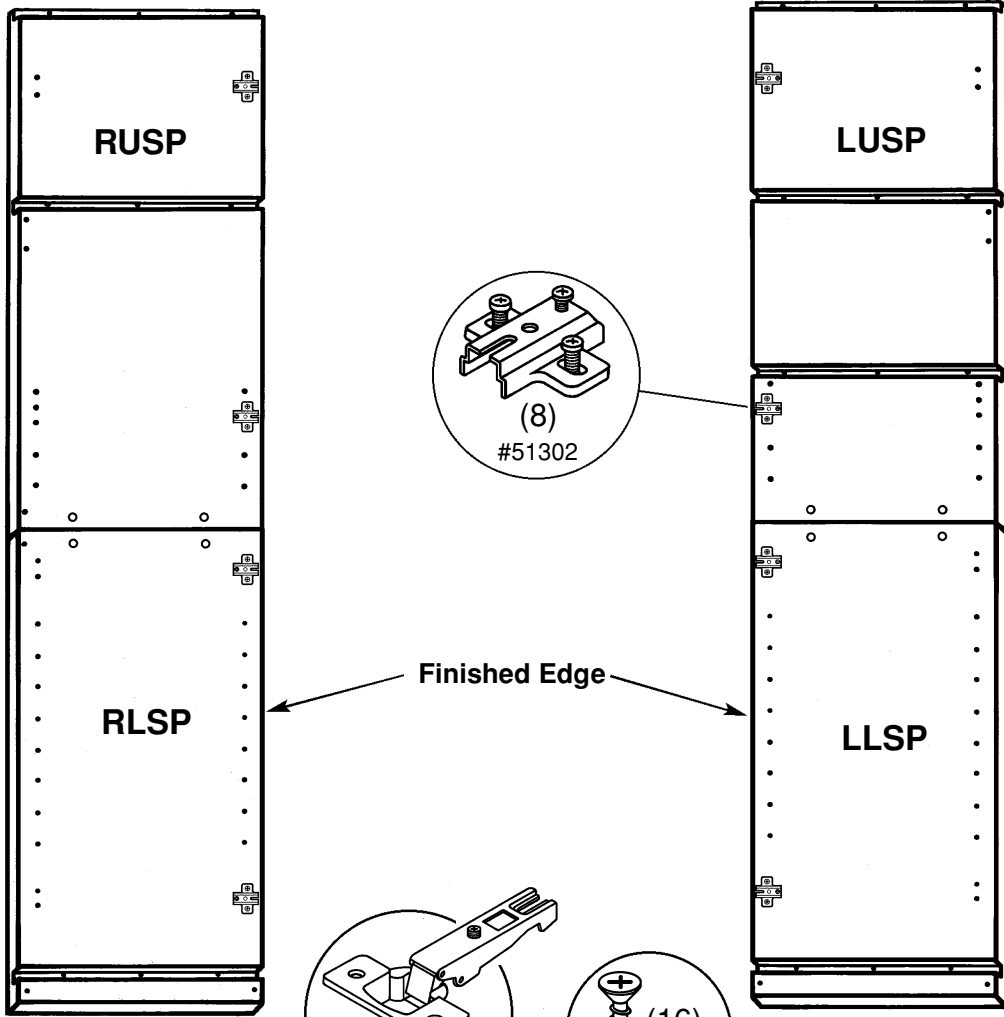

3

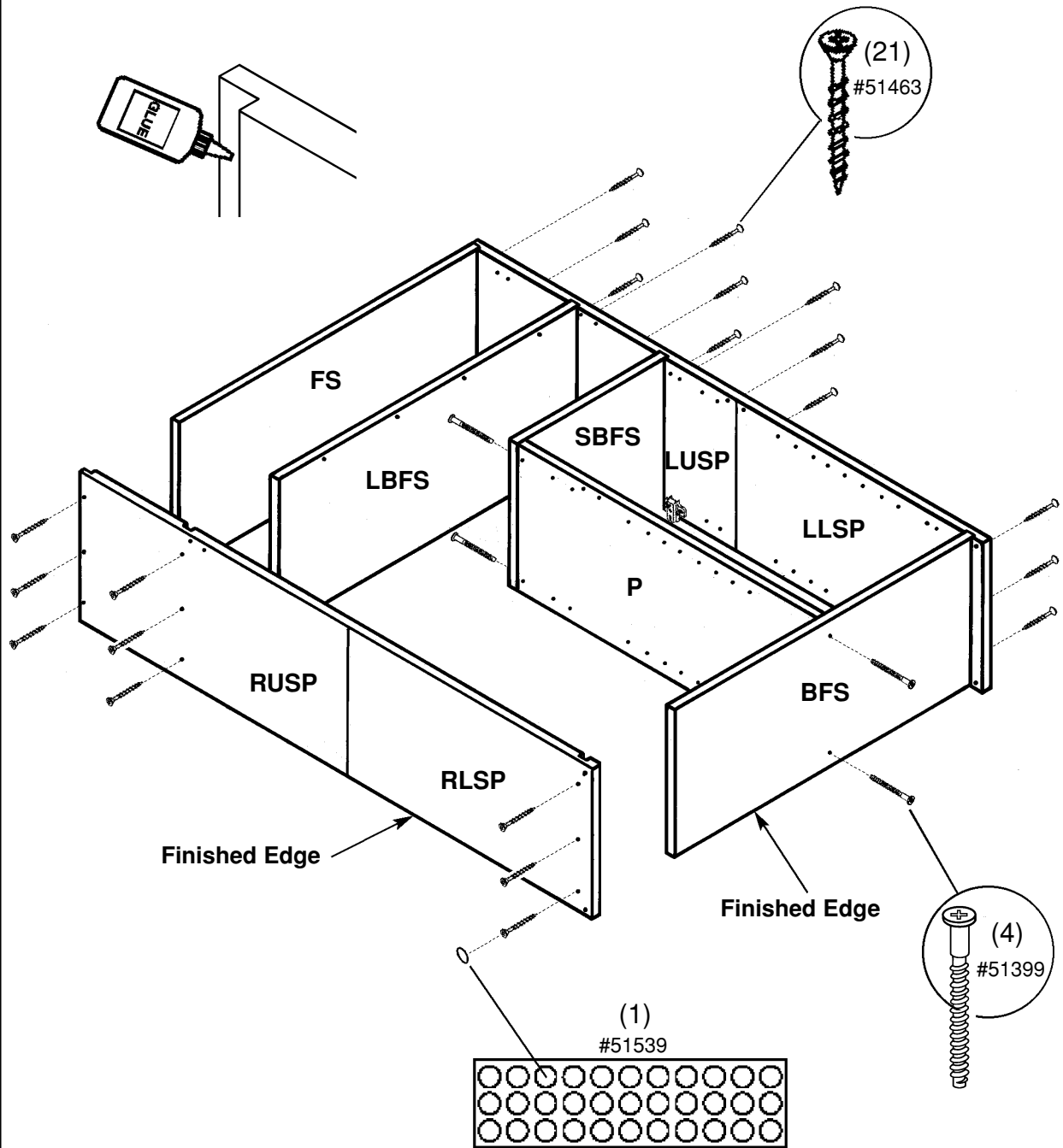

4

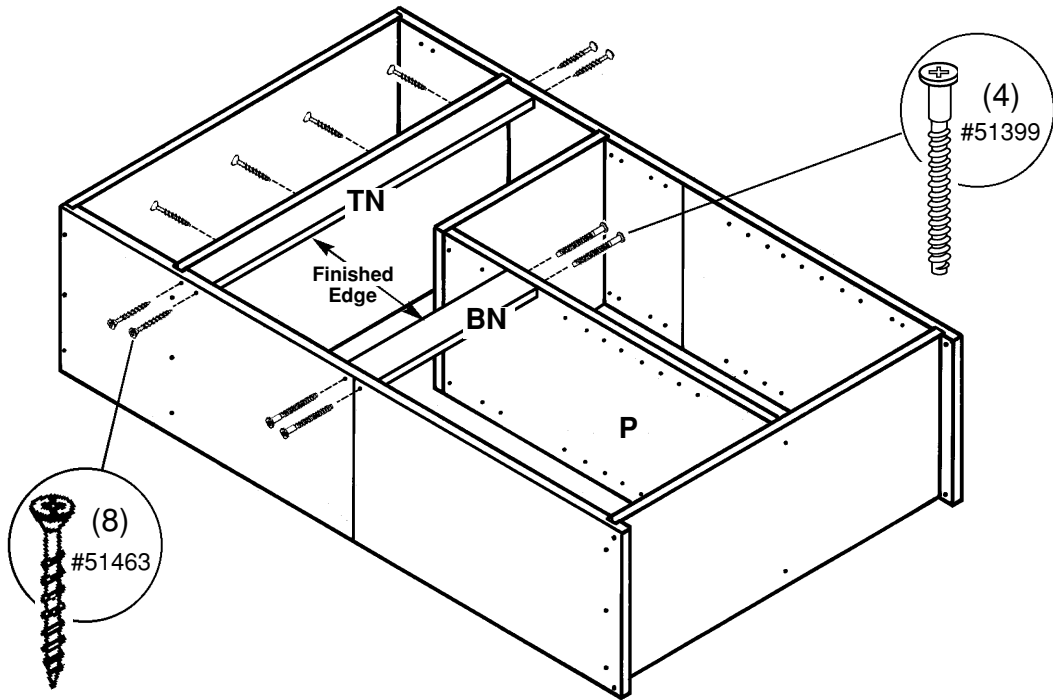

5

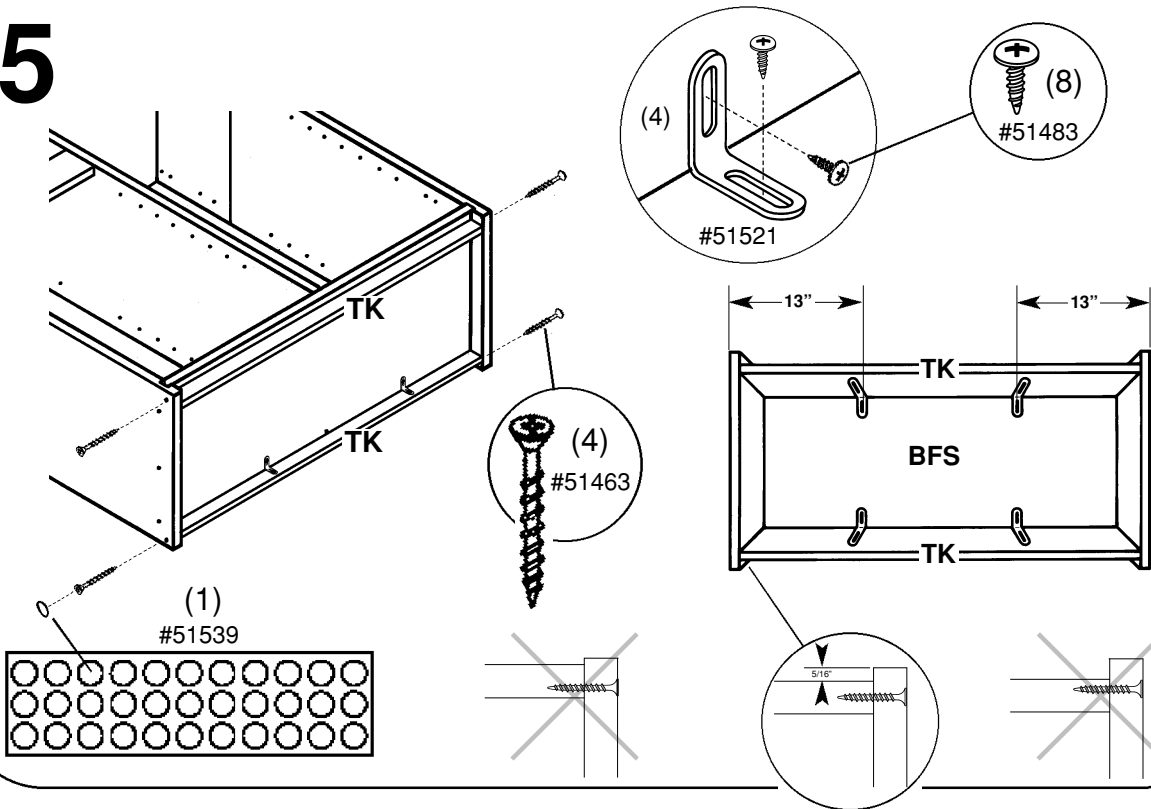

6

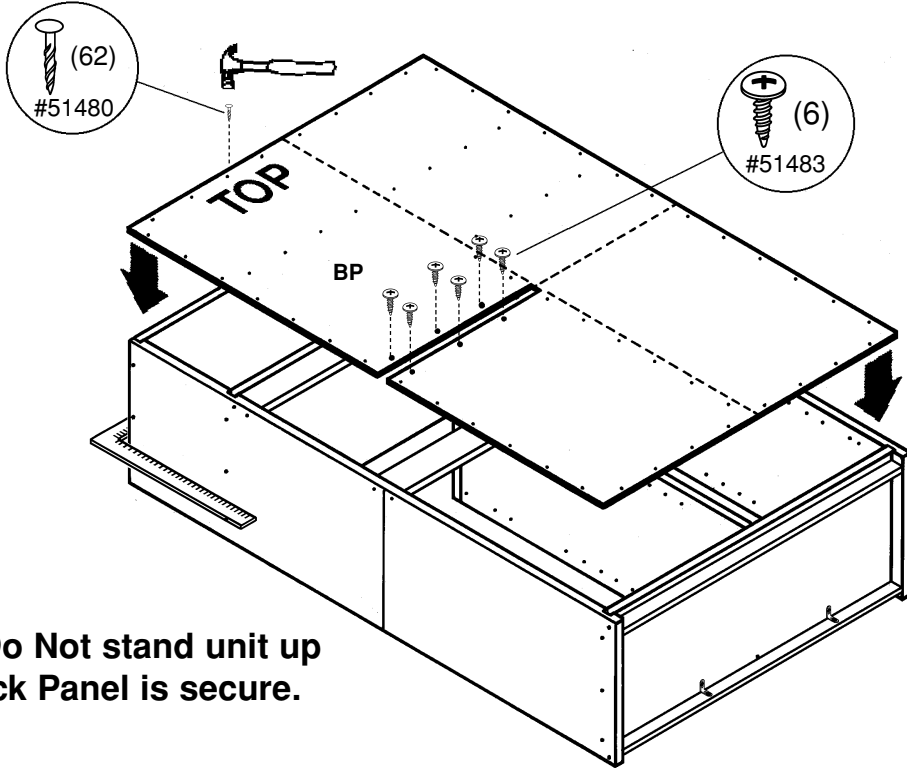

NOTE: Do Not stand unit up until Back Panel is secure.

7

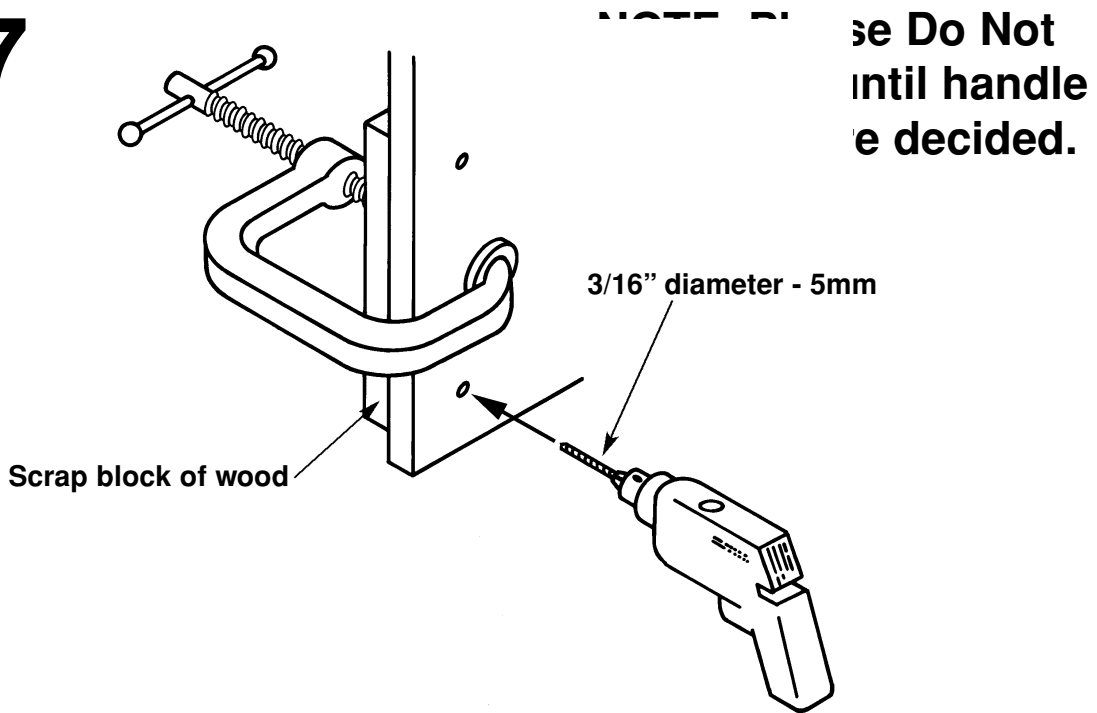

8

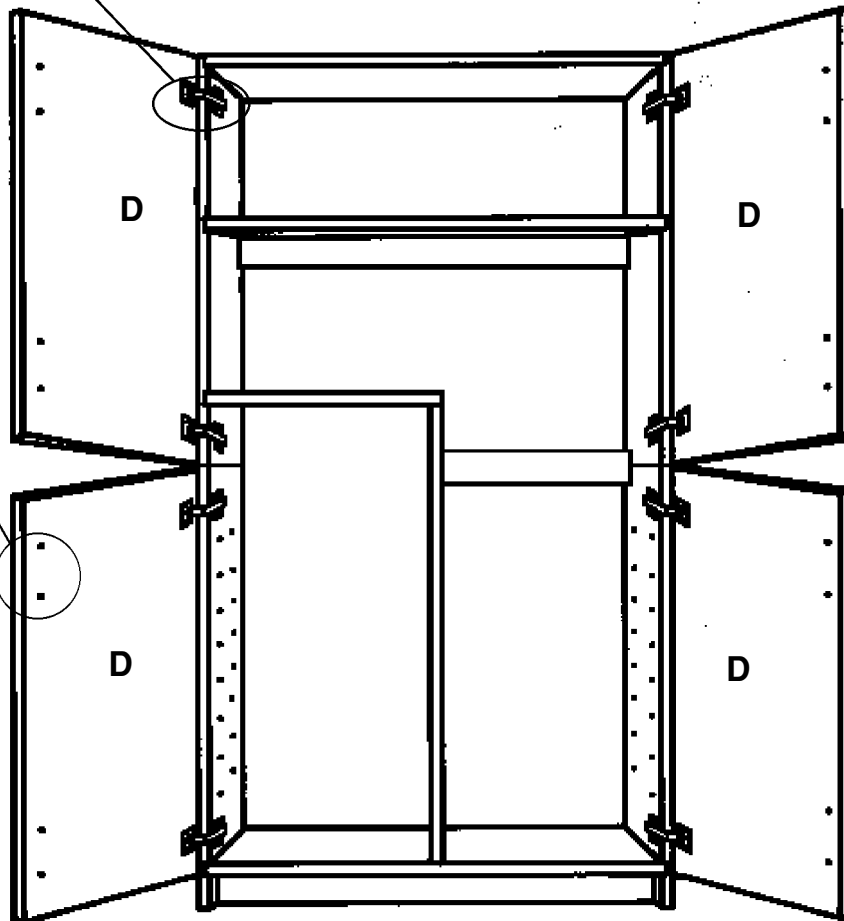
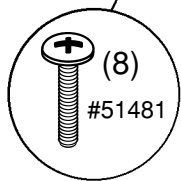
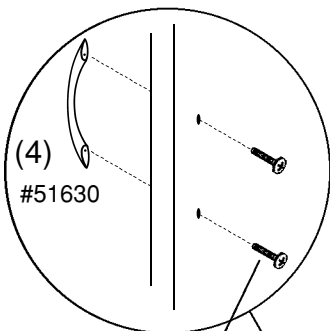
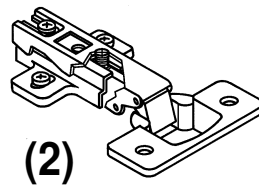
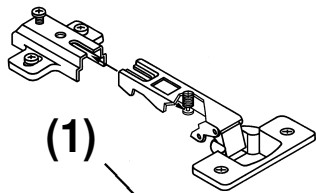

DOOR ADJUSTMENT / AJUSTES DE LA PUERTA / REGLAGE DES PORTES

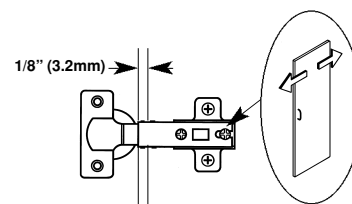
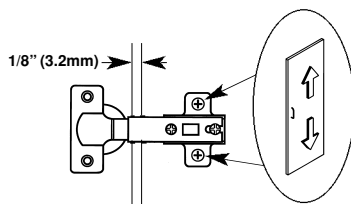
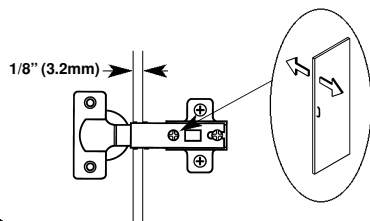

9

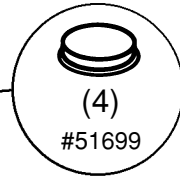
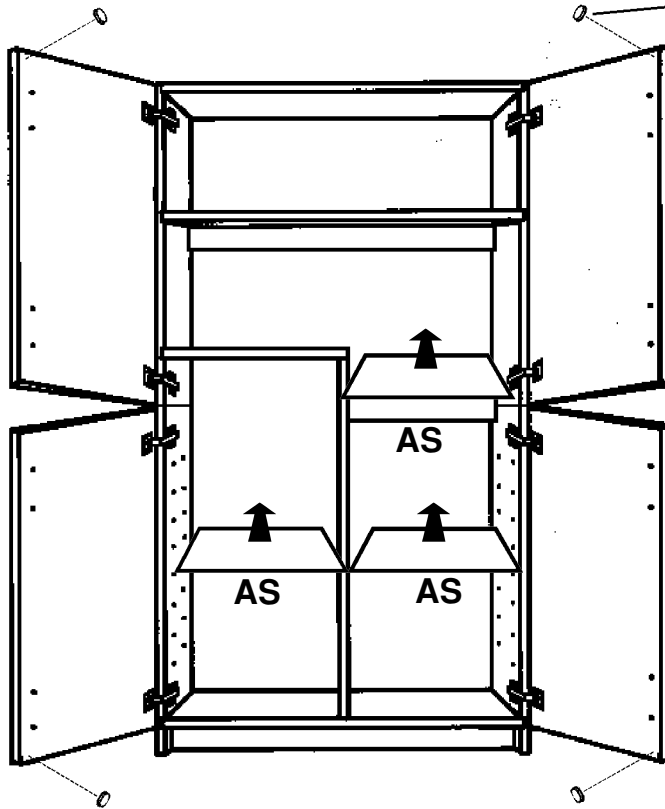
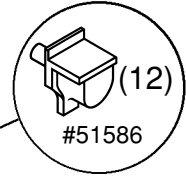
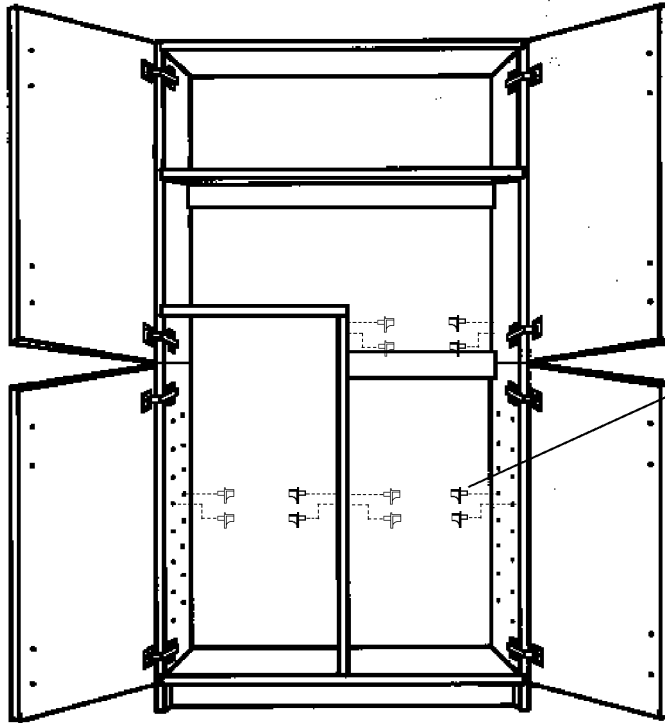

10

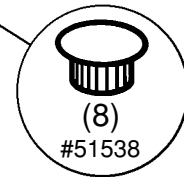
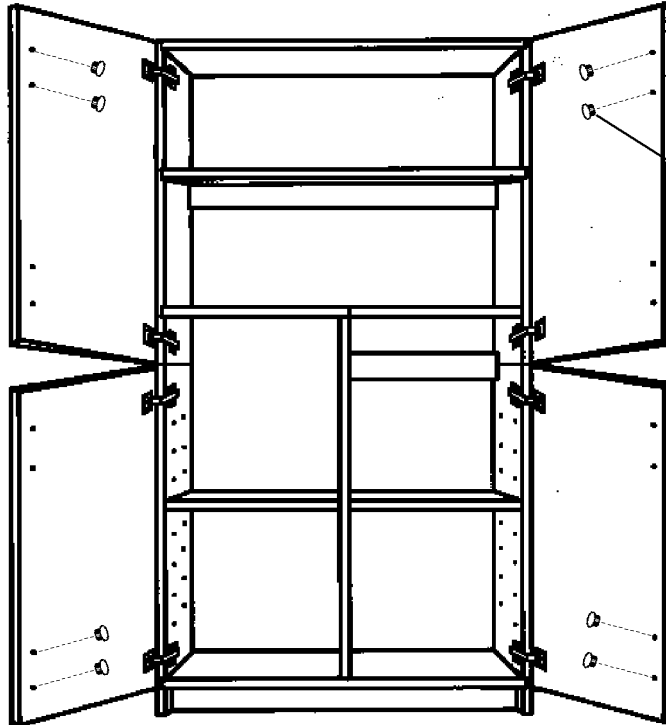

11

First, locate the studs in your wall. Fasten long wood screws securely into wall studs.

To prevent damage to cabinet, it must be attached to wall using furnished hardware.

