



# GUARDIAN PRO™ 240 SERIES

Models MLGC240B  
MLGC240W

## Features

- Turns on lighting when motion is detected.
- Automatically turns lighting off.
- Dual Light Level.
- Photocell keeps the lighting off during daylight hours.
- LED indicates motion was sensed (day or night).

This package includes:

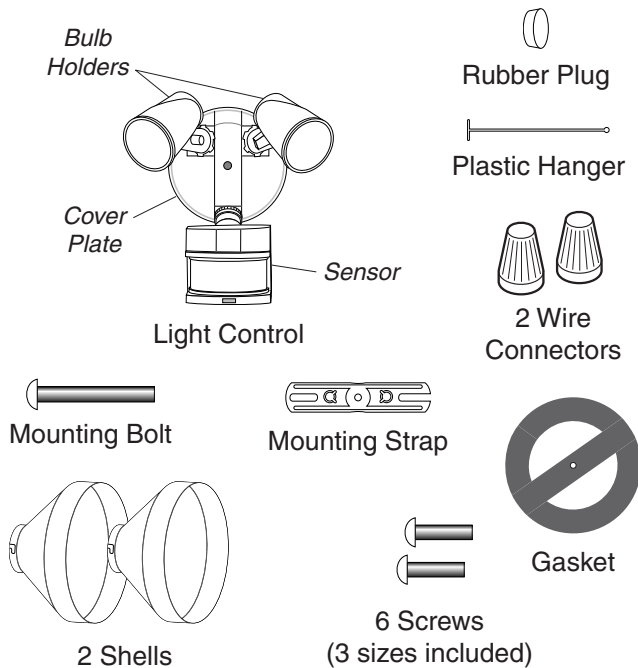

## Requirements

- The light control requires 120-volts AC.
- If you want to use Manual Mode, the control must be wired through a switch.
- **Some codes require installation by a qualified electrician.**
- This product is intended for use with the enclosed gasket and with a junction box marked for use in wet locations.

## OPERATION

| Mode:                   | On-Time          | Works: Day | Night |
|-------------------------|------------------|------------|-------|
| <b>Test</b>             | 5 Seconds        | x          | x     |
| <b>Auto</b>             | 1, 5, or 20 Min  |            | x     |
| <b>Manual</b>           | To Dawn*         |            | x     |
| <b>Dual Light Level</b> | 3, 6 Hr, to Dawn |            | x     |

\* resets to Auto Mode at dawn.

**Note:** When first turned on wait about 1 1/2 minutes for the circuitry to calibrate.

### TEST

Put ON-TIME switch on the sensor bottom to TEST and the Dual Light Level switch OFF.



### AUTO

Put the ON-TIME switch in the 1, 5, or 20 minute position.

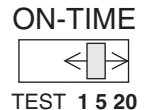

### MANUAL MODE

Manual mode only works at night because daylight returns the sensor to AUTO.

Flip the light switch off for one second then back on to toggle between AUTO and MANUAL MODE.

Manual mode works only with the ON-TIME switch in the 1, 5, or 20 position.

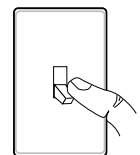

1 Second OFF then...

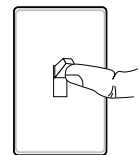

... back on.

## Mode Switching Summary

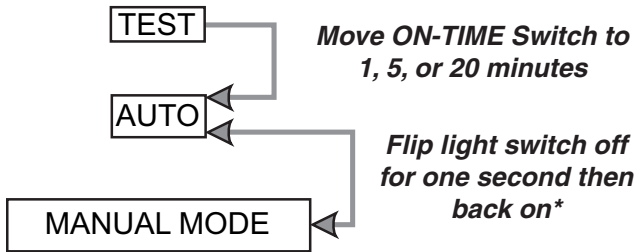

\* If you get confused while switching modes, turn the power off for one minute, then back on. After the calibration time the control will be in the AUTO mode.

## Dual Light Level Timer

Light comes on half bright for selected time after dusk (Off, 3 hr., 6 hr., until dawn). Selecting OFF disables this feature. The motion sensing features will continue to work as described in this manual. If motion is sensed, the light turns on full bright for the ON-TIME (1, 5, or 20 minutes) then returns to dim mode.

## INSTALLATION

For easy installation, select an existing light with a wall switch for replacement.

For best performance, mount the fixture about 8 ft. (2.4 m) above the ground. **NOTE:** If fixture is mounted higher than 8 ft. (2.4 m), aiming the sensor down will reduce coverage distance.

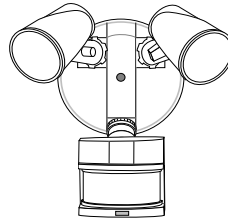

Wall Mount

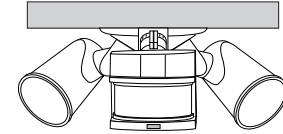

Eave Mount

**For under eave installation, the sensor head must be rotated** as shown in the next two steps for proper operation and to avoid the risk of electrical shock.

For eave mount only:

- Swing the sensor head towards the clamp screw joint.

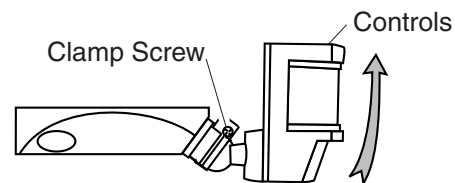

- Then rotate the sensor head clockwise 180° so the controls face down.

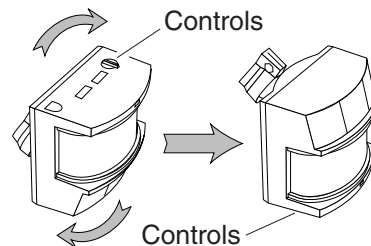

If the sensor pops out of the ball joint, loosen the clamp screw and push the sensor back into the ball joint. Tighten the clamp screw when done.

## Wire the Light Control

**⚠ WARNING: Turn power off at circuit breaker or fuse.**

- ❑ Remove the existing light fixture.
- ❑ Install the mounting strap as shown using two screws that fit your junction box.
- ❑ The plastic hanger can be used to hold the fixture while wiring. The small end of the plastic hanger can be threaded through the hole in the center of the cover plate. The small end then goes into one of the slots on the mounting strap.
- ❑ Route the light control's wires through the large gasket holes.
- ❑ Twist the junction box wires and fixture wires together as shown. Secure with wire connectors.

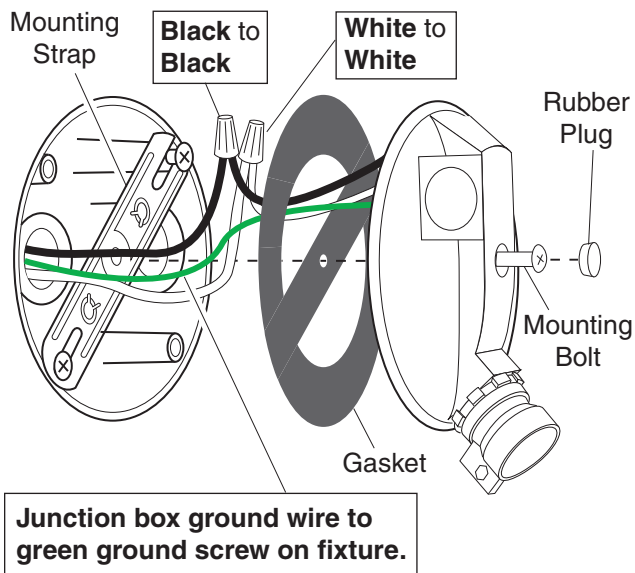

## Mount the Light Control

- ❑ Align the light control cover plate and cover plate gasket. Secure with the mounting bolt.
- ❑ Align the three slots in the decorative shell with the bulb holder pins. Push the shell in and then twist clockwise to lock. Repeat for other shell.

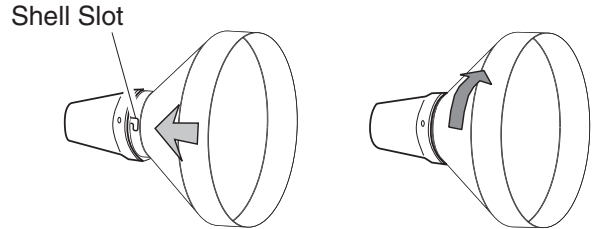

- ❑ Push the rubber plug firmly into place.
- ❑ If a wet location junction box was not used, caulk the wall plate mounting surface with silicone weather sealant.

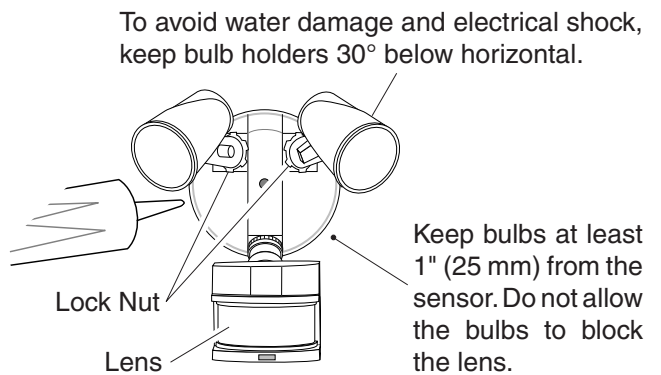

- ❑ Adjust the bulb holders by loosening the lock nuts but do not rotate the bulb holders more than 180° from the factory setting. When screwing in the floodlamps, do not overtighten.

# TEST AND ADJUSTMENT

- ❑ Turn on the circuit breaker and light switch.

**NOTE:** Sensor has a 1 1/2 minute warm up period before it will detect motion. When first turned on, wait 1 1/2 minutes.

- ❑ Turn the RANGE control to the medium position (halfway between MIN and MAX), Dual Light Level to OFF, and the ON-TIME control to the TEST position.

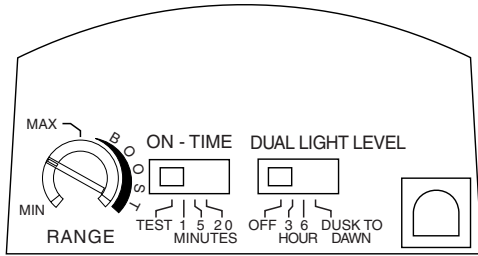

Bottom of Sensor

**Avoid aiming the control at:**

- Objects that change temperature rapidly, such as **heating vents and air conditioners**. These heat sources could cause false triggering.
- Areas where **pets or traffic** may trigger the control.
- **Nearby large, light-colored objects** reflecting light may trigger the shut-off feature. Do not point other lights at the sensor.

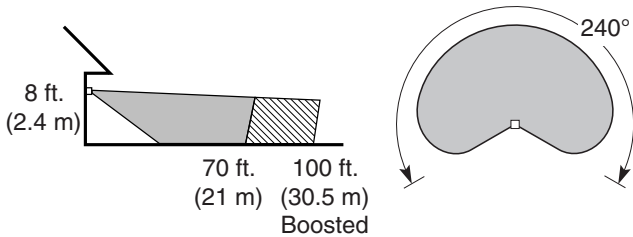

Maximum Range

Maximum Coverage Angle

**NOTE:** If fixture is mounted higher than 8 ft. (2.4 m), aiming the sensor down will reduce coverage distance. The detector is less sensitive to motion directly towards it.

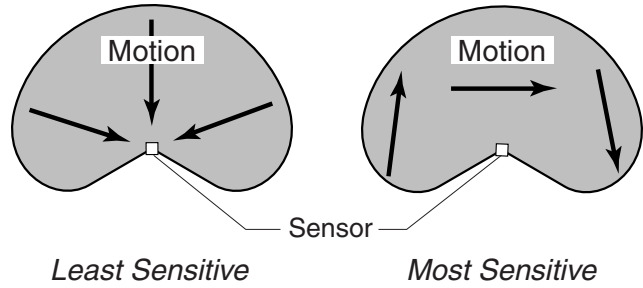

- ❑ Loosen the clamp screw in the sensor ball joint and gently rotate the sensor.
- ❑ Walk through the coverage area noting where you are when the lights turn on (also, the LED will flash several times when motion is detected). Move the sensor head up, down, or sideways to change the coverage area. **Keep the sensor at least 1" (25 mm) away from the bulbs.**
- ❑ Adjust the RANGE as needed. RANGE set too high may increase false triggering.
- ❑ **Secure the sensor head by tightening the clamp screw.** Do not overtighten the screw.
- ❑ Set the amount of TIME you want the lights to stay on after motion is detected (1, 5, or 20 minutes).
- ❑ Set the Dual Light Level switch to the amount of time after dusk you want the lights on at low level (Off, 3, 6 Hrs., Dusk-to-Dawn).

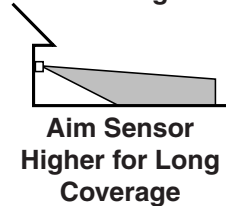
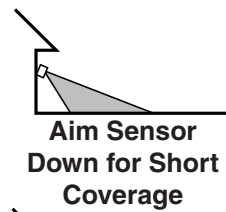
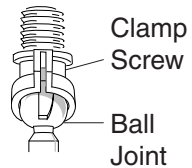

**⚠ WARNING: Risk of fire. Do not aim the bulbs at a combustible surface within 3 ft. (1 m).**

# SPECIFICATIONS

Range . . . . . Up to 70 ft. (21 m); 100 ft. (30.5m) with Range Boost. [varies with surrounding temperature]  
 Sensing Angle . . . . . Up to 240°  
 Electrical Load . . . . . Up to 300 Watt Maximum Incandescent [Up to 150 Watt maximum each bulb holder.]  
 Power Requirements . 120 VAC, 60 Hz  
 Replacement Lamp . . Up to 150 Watt Maximum PAR38 Incandescent or Halogen (Not CFL) Bulbs.

Operating Modes . . . . TEST, AUTO and MANUAL MODE  
 Time Delay . . . . . 1, 5, 20 minutes  
 Dual Light Level . . . . 3, 6 hours, Dusk-to-Dawn  
 Atlas Lighting Products, Inc. reserves the right to discontinue products and to change specifications at any time without incurring any obligation to incorporate new features in products previously sold.

# TROUBLESHOOTING GUIDE

If you experience a problem with your Light Control, first follow this guide. For additional assistance write to: Atlas Lighting Products, Inc. • Customer Service Department • P.O. Box 2348 • Burlington, NC 27216

| SYMPTOM   | POSSIBLE CAUSE   | SOLUTION  |
|---|--|---|
| Lights will not come on.                          | <ol style="list-style-type: none"> <li>1. Light switch is turned off.</li> <li>2. Flood lamp is loose or burned out.</li> <li>3. Fuse is blown or circuit breaker is turned off.</li> <li>4. Daylight turn-off is in effect.</li> <li>5. Incorrect circuit wiring, if this is a new installation.</li> <li>6. Light control aimed in wrong direction.</li> </ol>                 | <ol style="list-style-type: none"> <li>1. Turn light switch on.</li> <li>2. Check flood lamp and replace if burned out.</li> <li>3. Replace fuse or turn circuit breaker on.</li> <li>4. Recheck after dark.</li> <li>5. Verify wiring is correct.</li> <li>6. Re-aim light control to cover desired area.</li> </ol>                 |
| Lights come on in daylight.                       | <ol style="list-style-type: none"> <li>1. Light control may be installed in a relatively dark location.</li> <li>2. Light control is in TEST.</li> </ol>   | <ol style="list-style-type: none"> <li>1. The fixture is operating normally under these conditions.</li> <li>2. Set control switch to 1, 5, or 10 minutes.</li> </ol>   |
| Lights come on for no apparent reason.            | <ol style="list-style-type: none"> <li>1. Light control may be sensing small animals or automobile traffic.</li> <li>2. Range is set too high.</li> <li>3. Dual Light Level is on.</li> </ol>  | <ol style="list-style-type: none"> <li>1. Re-aim light control.</li> <li>2. Reduce range.</li> <li>3. The fixture is operating normally under these conditions.</li> </ol>  |
| Lights turn off too late in Dusk-to-Dawn setting. | Light control may be installed in a relatively dark location.  | Relocate light control, or use 3 hr. or 6 hr. setting.  |
| Lights stay on continuously.                      | <ol style="list-style-type: none"> <li>1. A flood lamp is positioned too close to the light control or pointed at nearby objects that cause heat to trigger the light control.</li> <li>2. The light control may be picking up a heat source like an air vent, dryer vent, or brightly painted, heat-reflective surface.</li> <li>3. Light control is in manual mode.</li> </ol> | <ol style="list-style-type: none"> <li>1. Reposition the flood lamp away from the light control or nearby objects.</li> <li>2. Reduce range.</li> <li>3. Switch light control to AUTO.</li> </ol>   |
| Lights flash on and off.                          | <ol style="list-style-type: none"> <li>1. Heat or light from the flood lamps may be turning the light control on and off.</li> <li>2. Heat being reflected from other objects may be turning the light control on and off.</li> <li>3. Light control is in the TEST mode and warming up.</li> <li>4. Light may be leaking through the flood lamp reflectors.</li> </ol>          | <ol style="list-style-type: none"> <li>1. Reposition the flood lamp away from the light control.</li> <li>2. Reposition light control.</li> <li>3. Flashing is normal under these conditions.</li> <li>4. Replace the flood lamps with new high quality PAR 38 lamps. (Make sure the metal lamp protectors are installed).</li> </ol> |
| Lights flash once, then stay off in manual mode.  | Light control is detecting its own lights.   | Reposition flood lamps to keep area below the light control relatively dark.  |

### **FIVE YEAR LIMITED WARRANTY**

Atlas Lighting Products, Inc. warrants against defects in materials or workmanship for a period of five years from the date of purchase for use, and agrees to repair or, at our option, replace a defective unit without charge for either parts or labor. **IMPORTANT:** This warranty does not cover damage resulting from accident, misuse of abuse, lack of reasonable care, the affixing of any attachment not provided with product, alteration of any attachments factory installed, loss of parts or subjecting the fixture to any but the specified electrical service. This warranty does not cover failure of the bulb due to accidents, abuse, misuse, vandalism, power surges, and acts of nature such as lightning damage. No responsibility is assumed for any special incidental or consequential damages. Damages occurring during transit are not covered by this warranty-including UPS shipments. To obtain warranty service, mail sales receipt as proof-of-purchase, date and a brief explanation of the nature of the defect, to the address listed below. You will receive, by mail, a Return Goods Authorization number and full instructions for returning defective merchandise. **All returned goods must be accompanied by a Return Goods Authorization number issued by Atlas Lighting Products, Inc.**

NOTE: No other warranty, written or verbal, is authorized by Atlas Lighting Products, Inc. This warranty gives you specific legal rights and you may also have other rights which vary from state to state. Some states do not allow the exclusion or limitation of incidental or consequential damages or limitations on how long an implied warranty lasts, so the above exclusion and limitations may not apply to you.

For information regarding replacement parts please write to:  
Atlas Lighting Products, Inc.  
Attn: Customer Service Department  
P.O. Box 2348  
Burlington, NC 27216



