

American Standard

ONE SPREAD LAVATORY FITTING

MODEL NUMBER

2064.801



650758-YYY0A
HANDLE ASSEMBLY

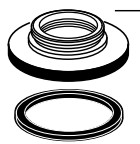

M962414-YYY0A
ESCUTCHEON KIT



918555-0070A
HANDLE SCREW



918049-0070A
HANDLE ADAPTER



994053-0070A
CARTRIDGE



M961634-0070A
VALVE MOUNTING KIT

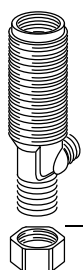

M962492-0070A
MOUNTING KIT



024220-0070A
COUPLING NUT

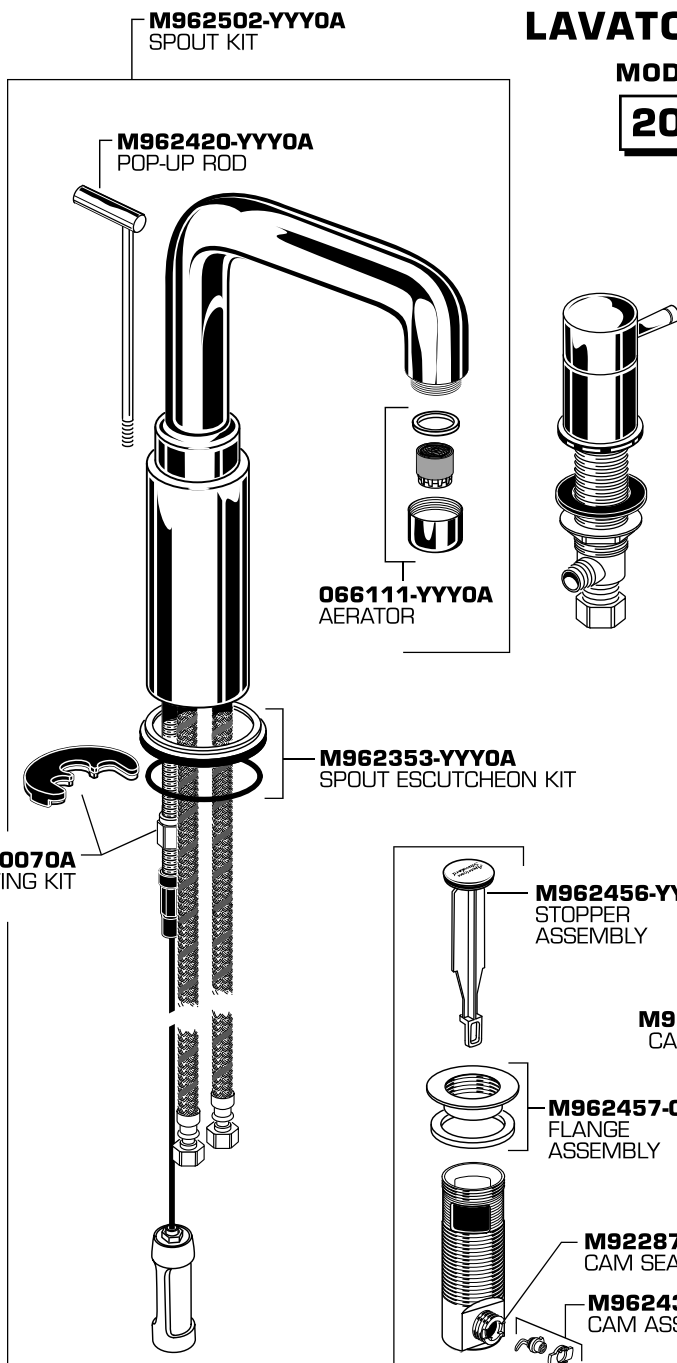

M962502-YYY0A
SPOUT KIT

M962420-YYY0A
POP-UP ROD

066111-YYY0A
AERATOR

M962353-YYY0A
SPOUT ESCUTCHEON KIT

M952425-YYY0A
DRAIN ASSEMBLY

M919660-0020A
6" TAILPIECE
(NOT INCLUDED WITH FAUCET)

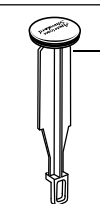

M962456-YYY0A
STOPPER ASSEMBLY

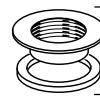

M962457-0070A
FLANGE ASSEMBLY

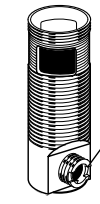

M922872-0070A
CAM SEAT INSERT



M962430-0070A
CAM ASSEMBLY



M913207-0070A
TAILPIECE INSERT

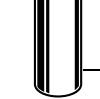

A919661-0020A
TAILPIECE



M962458-0070A
DRAIN MOUNTING KIT

M952430-0070A
CABLE ASSEMBLY

Replace the "YYY" with appropriate finish code

CHROME	002
SATIN NICKEL	295



HOT LINE FOR HELP
For toll-free information and answers to your questions, call:
1 (800) 442-1902
Weekdays 8:00 a.m. to 8:00 p.m. EST
IN CANADA 1-800-387-0369 (TORONTO 1-905-306-1093)
Weekdays 8:00 a.m. to 7:00 p.m. EST
IN MEXICO 01-800-839-12-00

Product names listed herein are trademarks of American Standard Inc.
© American Standard Inc. 2006

M968850