

Certified to comply with ANSI Z124.6
Observe local plumbing and building codes.

790760-100

Installation Instructions

CHANDLER™ KITCHEN SINK w/ DRAINBOARD

MODEL 7048.401 RIGHT HAND DRAIN BOARD
MODEL 7048.501 LEFT HAND DRAIN BOARD

Thank you for selecting American-Standard...the benchmark of fine quality for over 100 years. To ensure that your installation proceeds smoothly--please read these instructions carefully before you begin.

BEFORE YOU BEGIN... Unpack new sink and inspect carefully for damage. Replace the sink in its original packing carton to protect it until you are ready to begin installation.

Recommended Tools & Materials

- | | |
|----------------------|-----------------------------|
| Putty Knife | Basin Wrench |
| Pipe Wrench | Saber Saw |
| Channel Locks | Plumbers' Putty or Caulking |
| Phillips Screwdriver | Tubing Cutter |
| Regular Screwdriver | Tape Measure |
| Adjustable Wrench | Hacksaw |
| Drill | |

CUTOUT DIMENSIONS FOR SINK

Locate and mark center lines of sink on countertop. Provide proper clearance under the countertop for the faucet supply lines and the structural parts of the cabinet.

By using the diagram below and measuring your sink, draw the outline of the sink onto the countertop. This is not the cutting outline.

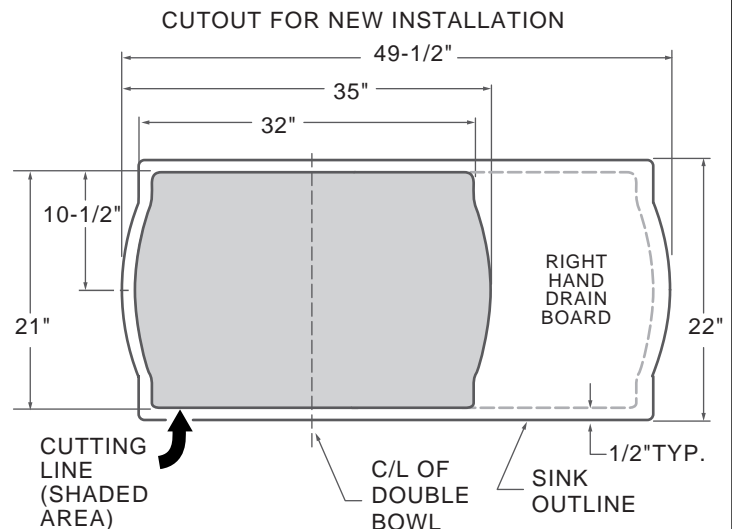

MODIFICATION REQUIRED TO FIT CHANDLER SINK INTO A STANDARD 33" X 22" SINK CUTOUT
NOTE: ALLOW ROOM ON EITHER SIDE OF SINK DEPENDING ON RIGHT OR LEFT HAND DRAIN BOARD

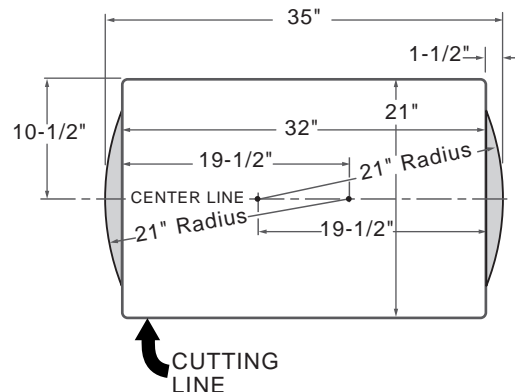

1 AFTER THE CUTOUT IS DRAWN...

Drill a clearance hole inside the cutout line as marked on the countertop.
NOTE: The drain-board is not part of the cut out and sits above the countertop.

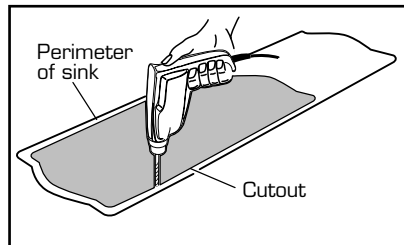

2

Cut opening on cut line inside the perimeter of bowl shape.

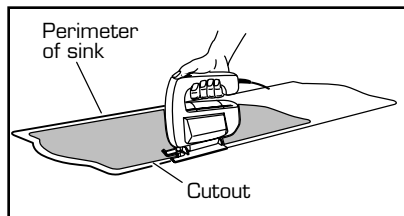

3

Mount the faucet and drain assembly on the sink following the manufacturer's instructions.

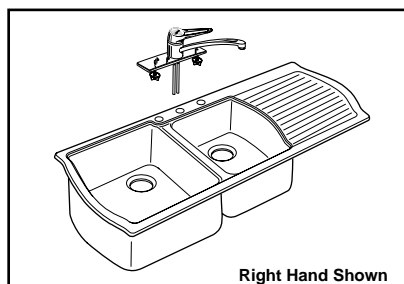

4

Before applying the sealant, place the sink temporarily into the cutout. Check for alignment and clearance, then trace around the outside edge of the sink as a guide for installation location and application of sealant. Remove sink.

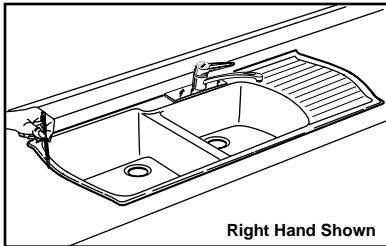

5

Apply a masking tape outline 1/8" outside traced outline as a guide for application of silicone sealant.

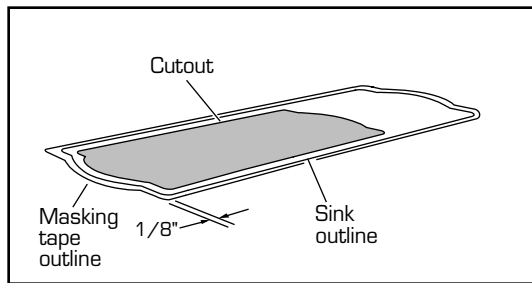

6

Apply a generous portion of silicone sealant inside line traced on countertop. Carefully lower sink into place and press down firmly. Use guidelines for proper positioning. Using water to dampen your finger, remove excess sealant for a smooth even line. Apply additional sealant if necessary to provide a uniform bead from the rim of sink to the masking tape line as shown. Carefully remove tape. Dampen finger and run it slightly over the sealant to remove any high spots.

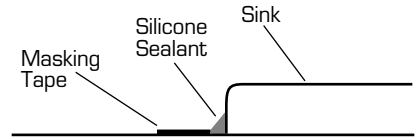

7

Connect supply lines to faucet finger tight, and carefully bend to engage with the supply stops. Tighten connections to faucet for secure seal.

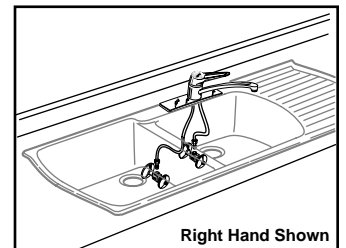

8

Connect drain assembly hand tight to check alignment. It may be necessary to cut off part of the tailpiece (area "A") or part of the horizontal leg of the trap (area "B").

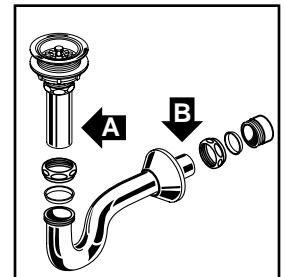

Secure joint for water-tight assembly.

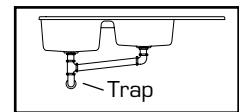

AMERICAN STANDARD TEN-YEAR LIMITED WARRANTY



CORIAN® SINK

If inspection of the Corian Sink of this American Standard product, within ten years after its initial purchase, confirms that it is defective in materials or workmanship, American Standard will repair or, at its option, exchange the product for a similar model.

This warranty applies only to the original purchaser and installation of these products. All labor and transportation costs or charges incidental to warranty service are to be borne by the original consumer-purchaser.

This limited warranty does not apply to local building code compliance. Since local building codes vary considerably, the purchaser of this product should check with a local building or plumbing contractor to insure local code compliance before installation.

This warranty shall be void if the product has been fabricated or modified in a manner inconsistent with the product as shipped by American-Standard; moved from its initial place of installation; if it has been subjected to faulty maintenance, abuse, misuse, accident or other damages; or if it was not installed in accordance with American Standard's instructions.

American Standard's option to repair or exchange the product under this warranty does not cover any labor or other costs of removal or installation, nor shall American Standard be responsible for any other incidental or consequential damages attributable to a product defect or to the repair or exchange of a defective product, all of which are expressly excluded from this warranty. (Some states or provinces do not allow the exclusion or limitation of implied warranties, so this exclusion may not apply to you.)

This warranty gives you specific legal rights. You may have other statutory rights that vary from state to state or from province to province, in which case this warranty does not affect such statutory rights.

In the United States:

American Standard Inc.,
P. O. Box 6820
Piscataway, NJ 08855
Attention: Director of Consumer Affairs

For residents of the United States, warranty information may also be obtained by calling the following toll free number: (800) 223-0068

In Mexico:

Customer Service Manager
Ideal Standard, S.A. de C.V.
Via Morelos #330
Col. Santa Clara
Ecatepec 55540 Edo. Mexico

In Canada:

American-Standard,
2480 Stanfield Road,
Mississauga, Ontario
Canada L4Y 1S2
Toll free: (800) 387-0369
Toronto Area: (905) 949-4800

Corian® Care & Maintenance Tips

Cleaning

Most dirt and stains Use soapy water or ammonia-based cleaner.

Water marks Wipe with damp cloth; towel dry.

Difficult stains Use an abrasive cleanser and a green Scotch-Brite® pad.

Disinfecting Occasionally wipe surface with diluted household bleach (1 part water/1 part bleach).

Maintenance Rub with Scotch-Brite® pad alone.

*Registered trademark of the 3M Company