

CHANDLER™ AMERICAST™ ISLAND SINK
WITH FAUCET HOLES 7182.001/7182.803
WITHOUT FAUCET HOLES 7182.000

Thank you for selecting American-Standard...the benchmark of fine quality for over 100 years.
To ensure that your installation proceeds smoothly--please read these instructions carefully before you begin.

Certified to comply with ANSI A112.19.4.M
U.S. Patent No. 4,664,982
Other patents pending.
CAN./C.S.A. B-45
Observe local plumbing and building codes.

791267-400 Rev. C

BEFORE YOU BEGIN...Unpack new sink and inspect carefully for damage. Replace the sink in its original packing carton to protect it until you are ready to begin installation.

Recommended Tools & Materials

- | | |
|----------------------|-----------------|
| Silicone Sealant | Mineral Spirits |
| Putty Knife | Basin Wrench |
| Pipe Wrench | Saber Saw |
| Channel Locks | Tubing Cutter |
| Phillips Screwdriver | Tape Measure |
| Regular Screwdriver | Hacksaw |
| Adjustable Wrench | Scissors |
| Drill | |

ISLAND SINK MODEL 7182.001/803

CUTOUT FOR NEW INSTALLATION

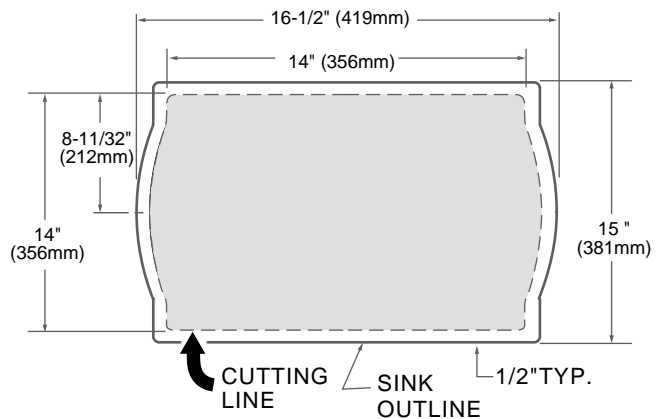

CUTOUT DIMENSIONS FOR SINK

Locate and mark center lines of sink on countertop. Provide proper clearance under the countertop for the faucet supply lines and the structural parts of the cabinet.

Cut out correct template and trace the cut line onto the countertop at the proper location.

NOTE: If replacing an existing sink be certain to shut off water supplies before removing old sink.

ISLAND SINK MODEL 7182.000

CUTOUT FOR NEW INSTALLATION

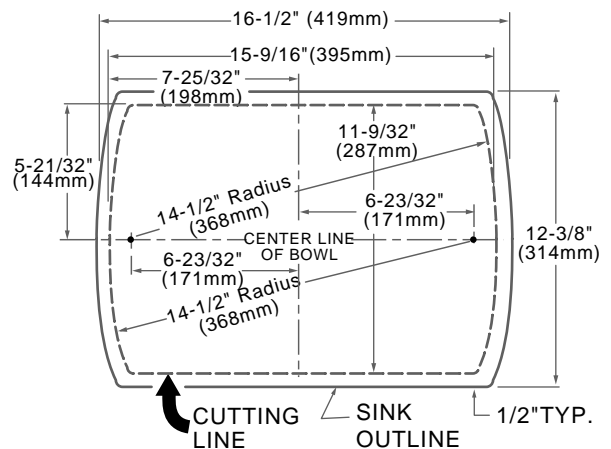

MODIFICATION REQUIRED TO FIT ISLAND SINK WITH FAUCET HOLES INTO A STANDARD 15" X 15" SINK CUTOUT

NOTE: CHANDLER ISLAND SINK WITHOUT FAUCET HOLES DOES NOT FIT INTO A STANDARD 15" X 15" SINK CUT OUT

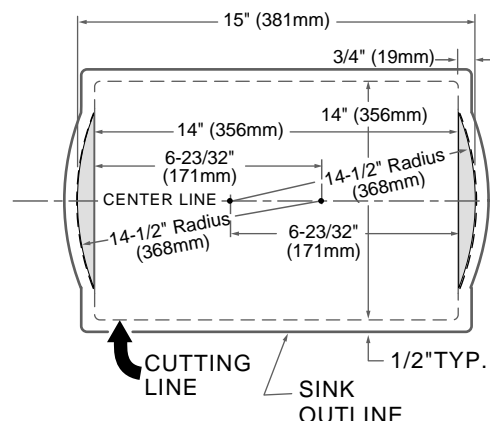

1 AFTER THE CUTOUT IS DRAWN...

Drill a clearance hole inside the cutout line as marked on the countertop.

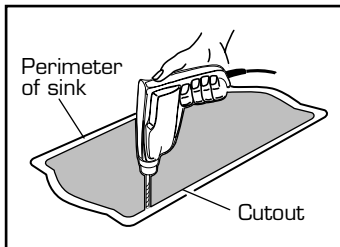

2

Cut opening on cut line inside the perimeter of sink.

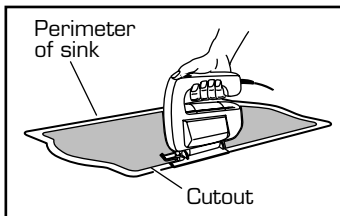

3

Mount the faucet and drain assembly on the sink following the manufacturer's instructions.

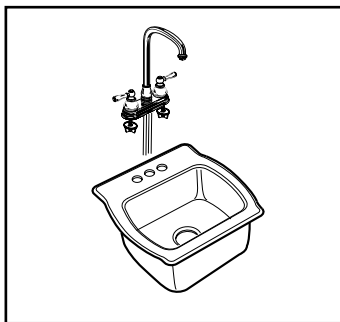

4

Before applying the sealant, place the sink temporarily into the cutout. Check for alignment and clearance, then trace around the outside edge of the sink as a guide for installation location and application of sealant. Remove sink.

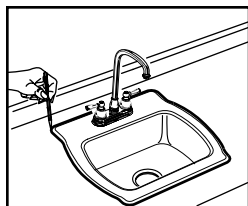

5

Apply a masking tape outline 1/8" outside traced outline as a guide for application of silicone sealant.

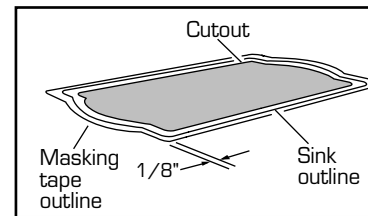

6

Apply a generous portion of silicone sealant inside line traced on countertop. Carefully lower sink into place and press down firmly. Use guidelines for proper positioning. Using water to dampen your finger, remove excess sealant for a smooth even line. Apply additional sealant if necessary to provide a uniform bead from the rim of sink to the masking tape line as shown. Carefully remove tape. Dampen finger and run it slightly over the sealant to remove any high spots. Use mineral spirits to remove excess silicone from countertop and sink.

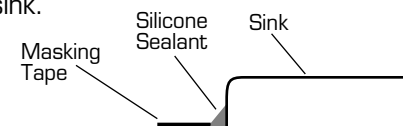

NOTE: Silicone must be removed within 10 minutes of application or a permanent residue may remain on the surfaces.

7

Connect supply lines to faucet finger tight, and carefully bend to engage with the supply stops. Tighten connections to faucet for secure seal.

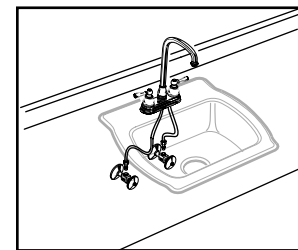

8

Connect drain assembly hand tight to check alignment. It may be necessary to cut off part of the tailpiece (area "A") or part of the horizontal leg of the trap (area "B").

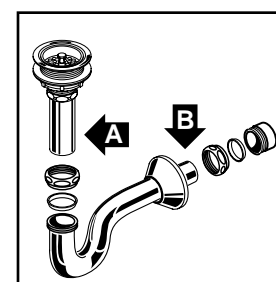

Secure joint for water-tight assembly.

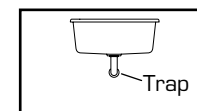

Single Bowl

AMERICAST® LIMITED LIFETIME WARRANTY

If an American-Standard Americast® brand product is found to be defective in materials or workmanship, after inspection by an authorized American-Standard representative, American-Standard will repair or, at its option, exchange the product for a similar model. This warranty extends for the lifetime of the product, so long as it remains in use in its original place of installation, except that the warranty applies to a bathing vessel's slip-resisting surface only for the first year after the product's initial installation.

This warranty applies only to the original purchaser and installation of these products.

This warranty **does not apply** to whirlpool components or to faucets, drains, mounting rims, grab bars or other accessories. If manufactured or supplied by American-Standard, such whirlpool components and accessories are covered under separate limited warranties.

This warranty **does not apply** to local building code compliance. Since local building codes vary considerably, the purchaser of this product should check with a local building or plumbing contractor to assure local code compliance before installation.

This warranty **shall be void** if the Americast® brand product has been moved from its initial place of installation; if it has been subjected to faulty maintenance, abuse, misuse, accident or other damage; if it was not installed in accordance with American-Standard's instructions; or if it was modified in a manner inconsistent with the product as shipped by American-Standard.

American-Standard's option to repair or exchange the product under this warranty does not cover any labor or other costs of removal or installation, **nor shall American-Standard be responsible for any other incidental or consequential damages attributable to a product defect or to the repair or exchange of a defective product, all of which are expressly excluded from this warranty.** (Some states or provinces do not allow the exclusion or limitation of implied warranties, so this exclusion may not apply to you.)

This warranty gives you specific legal rights. You may have other statutory rights that vary from state to state or from province to province, in which case this warranty does not affect such statutory rights.

For service under these warranties, it is suggested that a claim be made through the contractor or dealer from or through whom the product was purchased, or that a service request (including a description of the product model and of the defect) be sent to the following address:

In the United States:

American Standard Inc.,
P.O. Box 6820
Piscataway, New Jersey 08855
Attention: Director of Consumer Affairs

In Canada:

American-Standard,
2480 Stanfield Road
Mississauga, Ontario
Canada L4Y 1S2

For residents of the United States, warranty information may also be obtained by calling the following toll free number: (800) 442-1902

Toll Free: (800) 387-0369

CARE AND CLEANING...

For all porcelain enamel surfaces, regular, gentle care is best. The recommended way to preserve the finish, avoid scratches, and clean porcelain enamel fixtures is to rinse them with detergent and water. Generally, any of the light duty liquid dishwashing detergents, such as **Palmolive** or **Dawn**, work well. In areas where the water is hard, a heavy duty liquid laundry detergent such as liquid **Tide** will work better.

Product names listed herein are trademarks of American Standard Inc. unless otherwise noted. Palmolive® is a registered trademark of Colgate-Palmolive Co. Tide® and Dawn® are registered trademarks of Procter and Gamble.

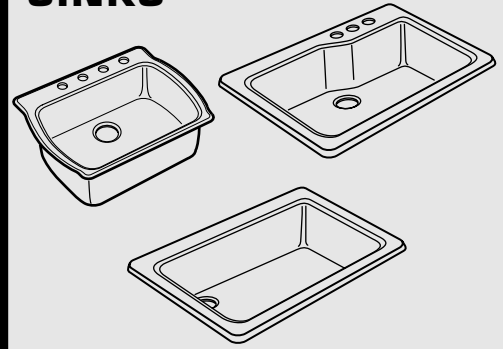

Certified to comply with ANSI A112.19.4.M
U.S. Patent No. 4,664,982
Other patents pending.
CAN/C.S.A. B-45
Observe local plumbing and building codes.

790088-100 REV. H

**UNDERCOUNTER MOUNTING FOR CHANDLER,
LAKELAND, PALISADE AND SILHOUETTE™
KITCHEN SINKS**

MODELS 7145, 7162, 7163 STANDARD, 7103, 7172, 7173, 7179,
7182, 7183, 7185, 7196, 7255

*Thank you for selecting American-Standard...the
benchmark of fine quality for over 100 years.
To ensure that your installation proceeds smoothly—please
read these instructions carefully before you begin.*

BEFORE YOU BEGIN...

Unpack new sink and inspect carefully for damage. Notify your American Standard distributor of any damage. Replace the sink in its original packing carton to protect it until you are ready to begin installation.

NOTE The kit contains two types of cutouts. One cutout is for mounting the fitting on the countertop. The second is for mounting the fitting on the sink itself, below the countertop. Use the correct instructions for your application

Recommended Tools & Materials:

- | | |
|----------------------|-----------------|
| Silicone Sealant | Drill |
| Putty Knife | Basin Wrench |
| Pipe Wrench | Saber Saw |
| Channel Locks | Tubing Cutter |
| Phillips Screwdriver | Tape Measure |
| Regular Screwdriver | Hacksaw |
| Adjustable Wrench | Mineral Spirits |

INSTALLATION A — FITTINGS MOUNTED ON COUNTERTOP

Refer to American Standard roughing-in information for specific dimensions for each model.

- CAUTION**
1. Minimum countertop thickness is 19mm (3/4) for wood and 12mm (1/2") for marble and solid surface material.
 2. Prior to cutting countertop be sure that the fitting shank has sufficient length to attach the mounting nut after the shank goes through both the countertop and sink deck. The deck is 3/8 (10mm) thick.

Below are the dimensions of each sink. Make sure this area is available to mount the sink. Unfold the template and refer to the instructions below.

SINK CUTOUTS:

- Locate and mark center lines of sink on countertop. Provide proper clearance under the countertop for the faucet supply lines and the structural parts of the cabinet. Do **not** use permanent markers to indicate the center lines.
- Cut the inner portion from the supplied template and discard.
- Attach the outer portion of the template to the countertop using masking tape. Be sure that the center lines on the template are aligned with those on the counter.

IMPORTANT: DIMENSIONS OF FIXTURES ARE NOMINAL AND MAY VARY WITHIN THE RANGE OF TOLERANCES ESTABLISHED BY A.N.S.I. AND C.S.A. STANDARDS.

SUPPORT CLIP LOCATIONS:

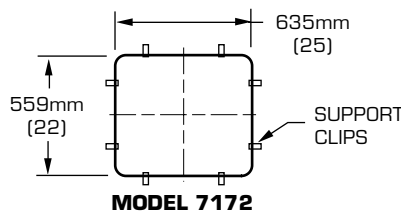
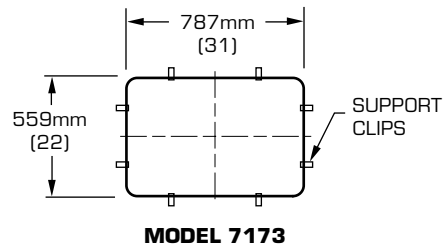
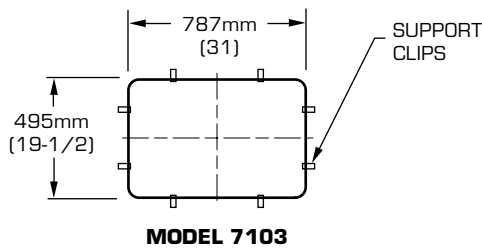
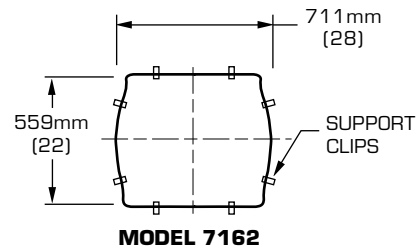
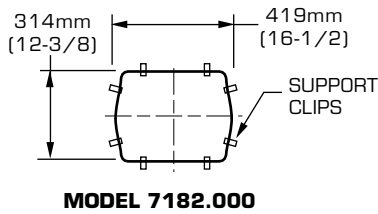
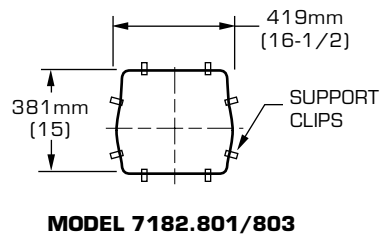
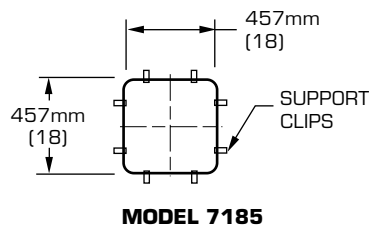
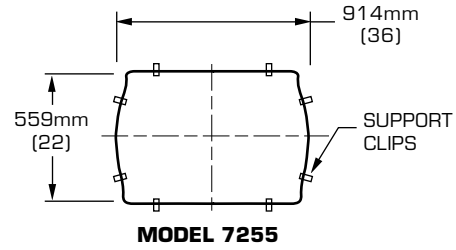
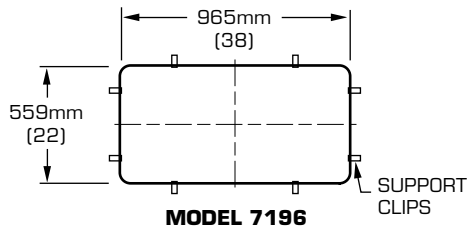
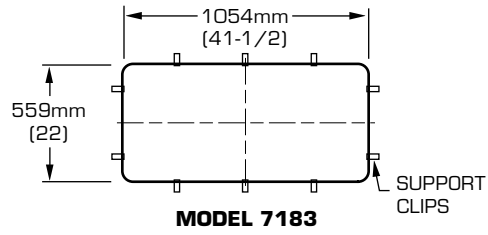
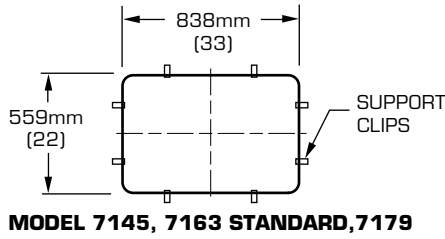

NOTE The following instructions are for countertop mounted fittings only. (Silhouette single bowl shown)

5

1

Drill a clearance hole inside the cutout line.

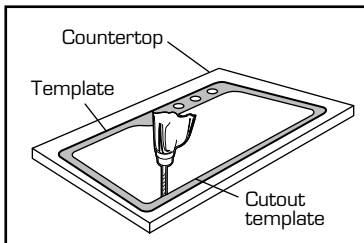

2

Cut opening on cut line of the template.
Note - Formica countertop installation only is illustrated. Contact your countertop distributor for the best method of cutting other materials such as marble, hard synthetics, etc.

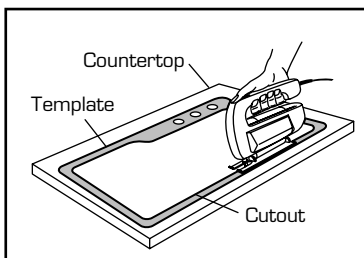

3

Cut fitting holes in the countertop and remove the template.

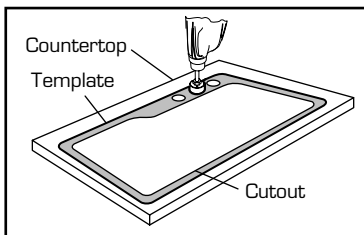

CAUTION

Prior to beveling the countertop edge, be sure that the fitting escutcheon does not extend onto the curved portion of the countertop.

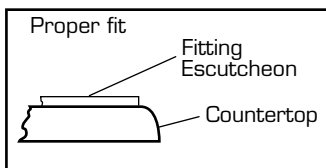

8

4

Attach at least four of the support clips to the underside of the countertop as shown below. The location of the clips should be as shown in the sink diagram. The wood screws are for use in wood, plywood, or particle board (drill appropriate pilot hole). The inserts supplied are for use in marble or hard synthetic material.

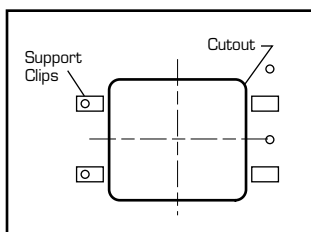

Apply a bead of sealant to the edge of the sink. Hold the sink against the under-side of the countertop and rotate the clips to hold the sink in place. Snug the screws to hold the sink. Attach all the additional clips.

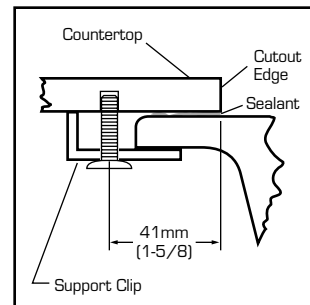

6

Mount the faucet and drain assembly following the manufacturer's instructions.

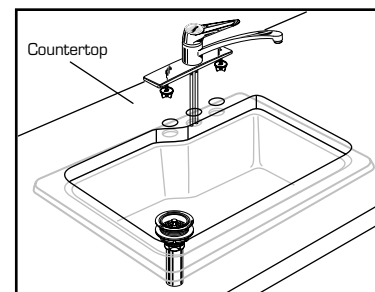

7

Connect supply lines to faucet finger tight, and carefully bend to engage with the supply stops. Tighten connections to faucet for secure seal.

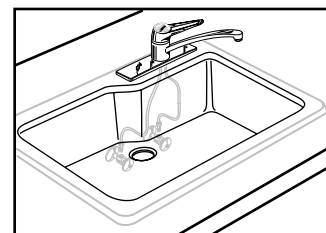

Connect drain assembly hand tight to check alignment. It may be necessary to cut off part of the tailpiece (area "A") or part of the horizontal leg of the trap (area "B").

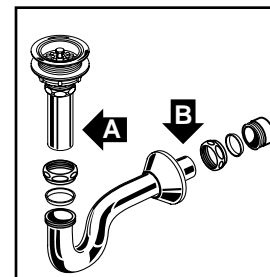

Secure joint for watertight assembly.

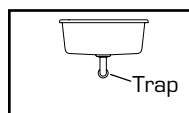

Single Bowl

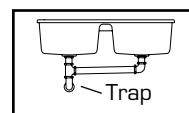

Double Bowl

END

INSTALLATION B — FITTINGS MOUNTED DIRECTLY ON SINK

Refer to American Standard roughing-in information for specific dimensions for each model.

Below are the dimensions of each sink. Make sure this area is available to mount the sink. Unfold the template and refer to the instructions below.

- CAUTION** 1. Minimum countertop thickness is 19mm (3/4) for wood and 12mm (1/2") for marble and solid surface materials.

SINK CUTOUTS:

- Locate and mark center lines of sink on countertop. Provide proper clearance under the countertop for the faucet supply lines and the structural parts of the cabinet. Do **not** use permanent markers to indicate the center lines.
- Cut the inner portion from the supplied template and discard.
- Attach the outer portion of the template to the countertop using masking tape. Be sure that the center lines on the template are aligned with those on the counter.

IMPORTANT: DIMENSIONS OF FIXTURES ARE NOMINAL AND MAY VARY WITHIN THE RANGE OF TOLERANCES ESTABLISHED BY A.N.S.I. AND C.S.A. STANDARDS.

SUPPORT CLIP LOCATIONS:

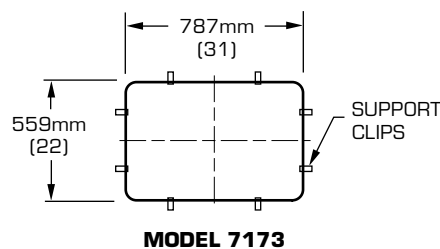
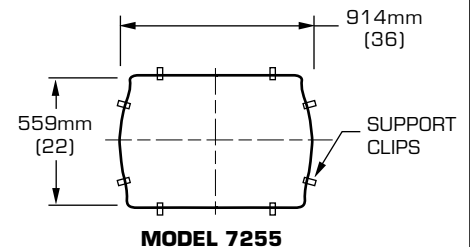
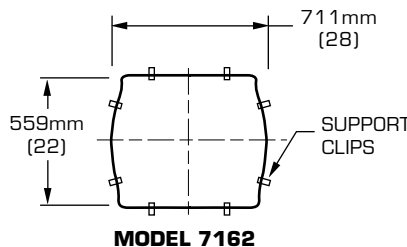
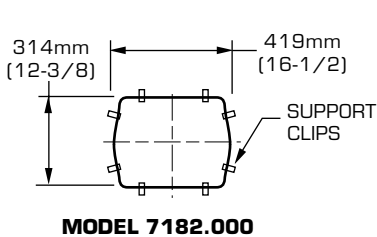
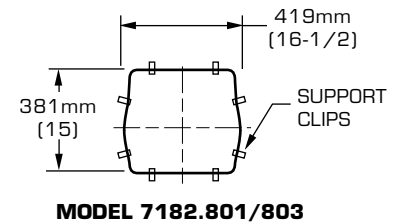
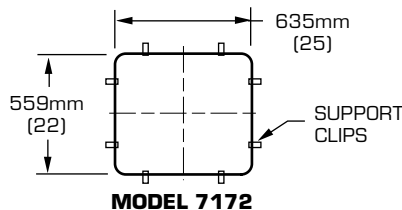
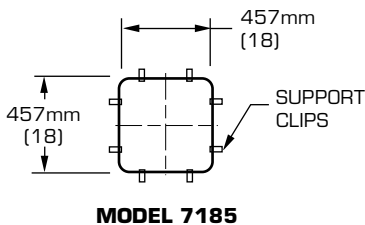
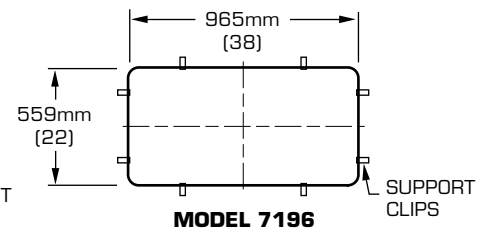
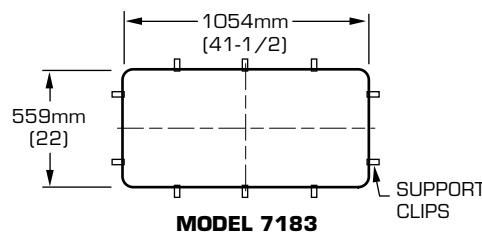
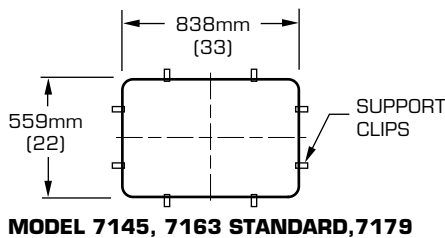

NOTE

The following instructions are for mounting fittings directly to the sink. (Silhouette single bowl shown)

1

Drill a clearance hole inside the cutout line.

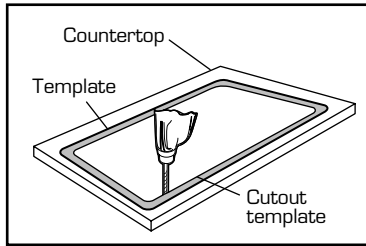
**2**

Cut opening on cut line of the template.

Note - Formica countertop installation only is illustrated. Contact your countertop distributor for the best method of cutting other materials such as marble, hard synthetics, etc.

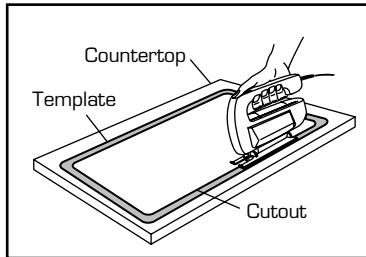
**3**

Attach at least four of the support clips to the underside of the countertop as shown below. The location of the clips should be as shown in the sink diagram. The wood screws are for use in wood, plywood, or particle board (drill appropriate pilot hole). The inserts supplied are for use in marble or hard synthetic material.

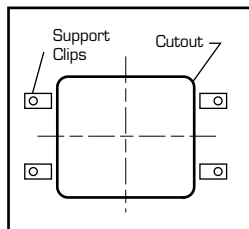
**4**

Apply a bead of sealant to the edge of the sink. Hold the sink against the under-side of the countertop and rotate the clips to hold the sink in place. Snug the screws to hold the sink. Attach all the additional clips.

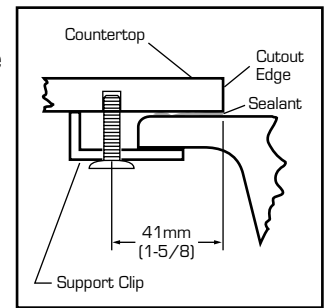
**5**

Mount the faucet and drain assembly following the manufacturer's instructions.

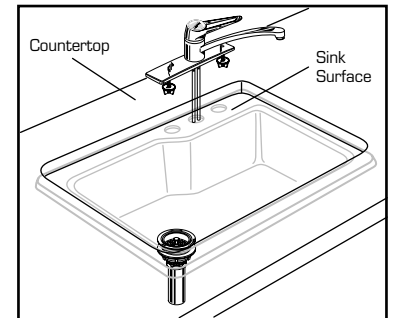
**6**

Connect supply lines to faucet finger tight, and carefully bend to engage with the supply stops. Tighten connections to faucet for secure seal.

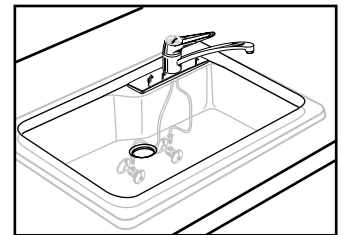
**7**

Connect drain assembly hand tight to check alignment. It may be necessary to cut off part of the tailpiece (area "A") or part of the horizontal leg of the trap (area "B").

Secure joint for watertight assembly.

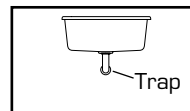
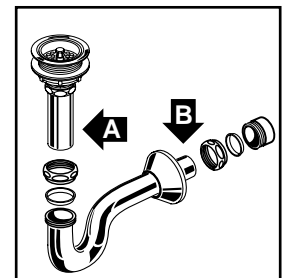

Single Bowl

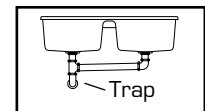

Double Bowl

AMERICAST® LIMITED LIFETIME WARRANTY

If an American-Standard Americast® brand product is found to be defective in materials or workmanship, after inspection by an authorized American-Standard representative, American-Standard will repair or, at its option, exchange the product for a similar model. This warranty extends for the lifetime of the product, so long as it remains in use in its original place of installation, except that the warranty applies to a bathing vessel's slip-resisting surface only for the first year after the product's initial installation.

This warranty applies only to the original purchaser and installation of these products.

This warranty **does not apply** to whirlpool components or to faucets, drains, mounting rims, grab bars or other accessories. If manufactured or supplied by American-Standard, such whirlpool components and accessories are covered under separate limited warranties.

This warranty **does not apply** to local building code compliance. Since local building codes vary considerably, the purchaser of this product should check with a local building or plumbing contractor to assure local code compliance before installation.

This warranty **shall be void** if the Americast® brand product has been moved from its initial place of installation; if it has been subjected to faulty maintenance, abuse, misuse, accident or other damage; if it was not installed in accordance with American-Standard's instructions; or if it was modified in a manner inconsistent with the product as shipped by American-Standard.

American-Standard's option to repair or exchange the product under this warranty does not cover any labor or other costs of removal or installation, **nor shall American-Standard be responsible for any other incidental or consequential damages attributable to a product defect or to the repair or exchange of a defective product, all of which are expressly excluded from this warranty.** (Some states or provinces do not allow the exclusion or limitation of implied warranties, so this exclusion may not apply to you.)

This warranty gives you specific legal rights. You may have other statutory rights that vary from state to state or from province to province, in which case this warranty does not affect such statutory rights.

For service under these warranties, it is suggested that a claim be made through the contractor or dealer from or through whom the product was purchased, or that a service request (including a description of the product model and of the defect) be sent to the following address:

In the United States:

American Standard Inc.,
P.O. Box 6820
Piscataway, New Jersey 08855
Attention: Director of Consumer Affairs

In Canada:

American-Standard,
2480 Stanfield Road
Mississauga, Ontario
Canada L4Y 1S2

For residents of the United States, warranty information may also be obtained by calling the following toll free number: (800) 442-1902

Toll Free: (800) 387-0369

CARE AND CLEANING...

For all porcelain enamel surfaces, regular, gentle care is best. The recommended way to preserve the finish, avoid scratches, and clean porcelain enamel fixtures is to rinse them with detergent and water. Generally, any of the light duty liquid dishwashing detergents, such as **Palmolive** or **Dawn**, work well. In areas where the water is hard, a heavy duty liquid laundry detergent such as liquid **Tide** will work better.

Product names listed herein are trademarks of American Standard Inc. unless otherwise noted. Palmolive® is a registered trademark of Colgate-Palmolive Co. Tide® and Dawn® are registered trademarks of Procter and Gamble.