

VENTURER

***SURROUND SOUND
HOME THEATER SYSTEM***

DVD
INPUT

AUX
INPUT

GAME
INPUT

Instruction Manual

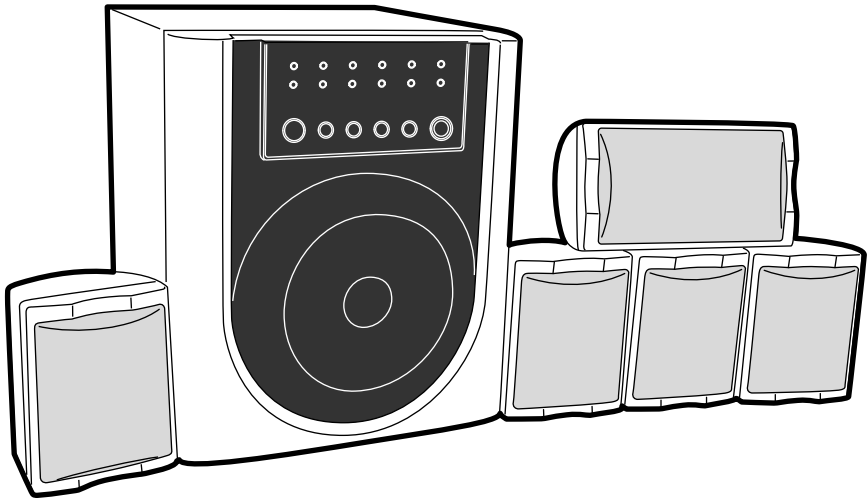

Model ASR150

Please read the instruction manual carefully before using your unit.

For support visit : www.1800customersupport.com

GENERAL

TABLE OF CONTENTS

PRECAUTIONS	2
IMPORTANT SAFETY INSTRUCTIONS	3
FUNCTION CONTROL	4
Front Panel	4
Back Panel	4
Remote Control	5
Using the remote control correctly	5
To change remote battery	5
Battery replacement	5
CONNECTIONS	6
Power connection	6
Connecting the speakers & subwoofer	6
Mounting the rear surround speakers	6
Positioning the speakers & subwoofer	7
Connection with TV	8
Connection with TV Game	8
Connection with DVD player	8
Connection with VCR	8
Connection with other equipment	8
Set up diagram	9
SOUND ADJUSTMENT	10
To adjust the master volume	10
To adjust the volume of individual speaker	10
To change the preset equalizer	10
To change the speaker channel	10
TROUBLE SHOOTING GUIDE	11
OPERATING VOLTAGE	11



INTRODUCTION



Thank you for purchasing this Surround Sound Home Theater System. Please read this instruction manual for best results.

SUPPLIED ACCESSORIES

Remote control with battery	x1
Satellite speaker	x5
Audio cable	x1
Instruction manual	x1

PRECAUTIONS

	CAUTION RISK OF ELECTRIC SHOCK DO NOT OPEN	
WARNING: TO REDUCE THE RISK OF ELECTRIC SHOCK, DO NOT REMOVE COVER (OR BACK). NO USER-SERVICEABLE PARTS INSIDE. REFER SERVICING TO QUALIFIED SERVICE PERSONNEL.		

	The lightning flash with an arrowhead symbol, within the equilateral triangle, is intended to alert the user to the presence of uninsulated "dangerous voltage" within the product's enclosure that may be of sufficient magnitude to cause an electric shock.
	The exclamation point within the equilateral triangle is intended to alert the user to the presence of important operating and maintenance (servicing) instructions in this owner manual.

WARNING: TO PREVENT FIRE OR SHOCK HAZARD, DO NOT EXPOSE THIS APPLIANCE TO RAIN OR MOISTURE.

CAUTION: TO PREVENT ELECTRIC SHOCK, MATCH WIDE BLADE OF PLUG TO WIDE SLOT, FULLY INSERT. (FOR USA AND CANADA ONLY)



The symbol for Class II (Double Insulation)

FCC Information

This device complies with Part 15 of FCC Rules.

Operation is subject to the following two conditions:

- (1) This device may not cause harmful interference, and
- (2) This device must accept any interference received, including interference that may cause undesirable operation.

Notes on Placement

- Do not use the unit in places which are extremely hot, cold, dusty, or humid.
- Place the unit on a flat and even surface.
- In a cabinet, allow about 2.5cm (1 inch) of free space around the unit for adequate ventilation.
- Do not restrict the air flow of the unit by placing it in a place with poor air flow, by covering it with a cloth, or by placing it on carpet.

Notes on Safety

- When connecting or disconnecting the AC cord, grip the plug and not the cord itself. Pulling the cord may damage it and create a hazard.
- Unplug the unit during lightning storms or when unused for a long period of time.
- Check that the rated voltage of your unit matches your local voltage before use.
- No naked flame sources, such as lighted candles, should be placed on the apparatus.
- Be sure to use it near the wall outlet. If a malfunction occurs, disconnect the plug from the wall outlet at once.
- When the AC power supply cord is connected, the power indicator on the AC Adaptor will remain on although the unit is turned off. Disconnect the AC power supply cord from the AC outlet when not in use.

Note on Condensation

- When left in a heated room where is warm and damp, water droplets or condensation may form inside the unit. When there is condensation inside, the unit may not function normally. Let the unit stand for 1 to 2 hours before turning the power on, or gradually heat the room up and dry the unit before use.

Notes on Maintenance

- Do not use volatile chemicals on this unit. Clean by lightly wiping with a soft cloth.
- Do not place a heavy object on or step on the unit. The object may fall, causing serious personal injury and serious damage to the unit.
- Protect the power cord from being walked on or pinched particularly at plugs, convenience receptacles, and the point where they exit from the unit.

WARNING:

- **Should any trouble occur, disconnect the AC power cord and refer servicing to a qualified technician.**
- **Do not place anything directly on top of the unit, it may cause damage.**

IMPORTANT SAFETY INSTRUCTIONS

1. **Read Instructions** - All the safety and operating instructions should be read before the appliance is operated.
2. **Retain Instructions** - The safety and operating instructions should be retained for future reference.
3. **Heed Warnings** - All warnings on the appliance and in the operating instructions should be adhered to.
4. **Follow Instructions** - All operating and use instructions should be followed.
5. **Water and Moisture** - The appliance should not be used near water - for example, near a bathtub, washbowl, kitchen sink, laundry tub, in a wet basement, or near a swimming pool, and the like.
6. **Carts and Stands** - The appliance should be used only with a cart or stand that is recommended by the manufacturer.
- 6A. An appliance and cart combination should be moved with care. Quick stops, excessive force, and uneven surfaces may cause the appliance and cart combination to overturn.
7. **Wall or Ceiling Mounting** - The appliance should be mounted to a wall or ceiling only as recommended by the manufacturer.
8. **Ventilation** - The appliance should be situated so that its location or position does not interfere with its proper ventilation. For example, the appliance should not be situated on a bed, sofa, rug, or similar surface that may block the ventilation openings; or, placed in a built-in installation, such as a book case or cabinet, that may impede the flow of air through the ventilation openings.
9. **Heat** - The appliance should be situated away from heat sources such as radiators, heat registers, stoves, or other appliances (including amplifiers) that produce heat.
10. **Power Sources** - The appliance should be connected to a power supply only of the type described in the operating instructions or as marked on the appliance.
11. **Grounding or Polarization** - Precautions should be taken so that the grounding or polarization means of an appliance are not defeated.
12. **Power-Cord Protection** - Power-supply cords should be routed so that they are not likely to be walked on or pinched by items placed upon or against them, paying particular attention to cords at plugs, convenience receptacles, and the point where they exit from the appliance.
13. **Cleaning** - The appliance should be cleaned only as recommended by the manufacturer.
14. **Power Lines** - An outdoor antenna should be located away from power lines.
15. **Outdoor Antenna Grounding** - If an outside antenna is connected to the receiver, be sure the antenna system is grounded so as to provide some protection against voltage surges and built up static charges. Section 810 of the National Electrical Code, ANSI/NFPA No. 70, provides information with respect to proper grounding of the mast and supporting structure, grounding of the lead-in wire to an antenna discharge unit, size of grounding conductors, location of antenna-discharge unit, connection to grounding electrodes, and requirements for the grounding electrode. See Figure 1.
16. **Non-use Periods** - The power cord of the appliance should be unplugged from the outlet when left unused for a long period of time.
17. **Object and Liquid Entry** - Care should be taken so that objects do not fall, and liquids are not spilled, into the enclosure through openings.
18. **Damage Requiring Service** - The appliance should be serviced by qualified service personnel when:
 - A. The power-supply cord or the plug has been damaged; or
 - B. Objects have fallen, or liquid has been spilled, into the appliance; or
 - C. The appliance has been exposed to rain; or
 - D. The appliance does not appear to operate normally or exhibits a marked change in performance; or
 - E. The appliance has been dropped, or the enclosure damaged.
19. **Servicing** - The user should not attempt to service the appliance beyond that described in the operating instructions. All other servicing should be referred to qualified service personnel.

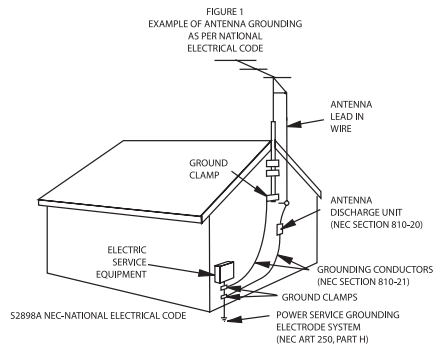

FUNCTION CONTROL

FRONT PANEL

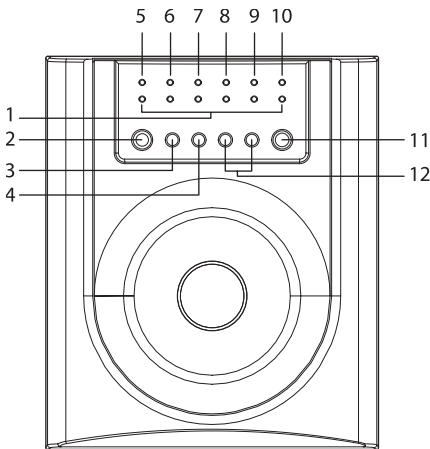

- 1. SPEAKER indicators**
Lights when the corresponding speaker is active.
- 2. STANDBY/ON button**
Turns the unit ON, or puts the unit into STANDBY mode.
- 3. INPUT SOURCE button**
Select the sound input source to AUX, GAME or DVD.
- 4. SPEAKER CHANNELS button**
Select 2.1 channel or 5.1 channel listening mode.
- 5. STANDBY indicator**
Lights when the unit is in standby mode.
- 6. DVD indicator**
Lights when the unit is in DVD mode.
- 7. GAME indicator**
Lights when the unit is in GAME mode.
- 8. AUX indicator**
Lights when the unit is in AUX mode.
- 9. 2.1 CHANNEL indicator**
Lights when the listening mode is in 2.1 channel.
- 10. 5.1 CHANNEL indicator**
Lights when the listening mode is in 5.1 channel.
- 11. Remote Control sensor**
Accepts the remote control signals.
- 12. VOLUME +/- button**
Adjust the volume or the level of all speakers.

BACK PANEL

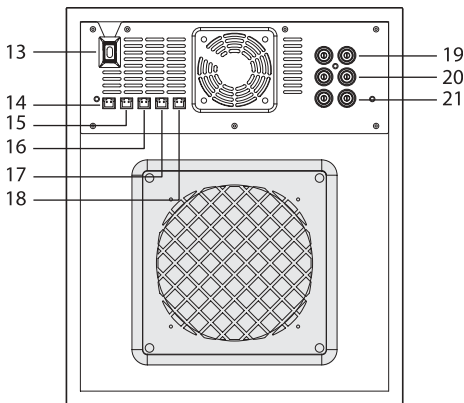

- 13. POWER CORD**
Connect the power cord to the wall outlet.
- 14. RIGHT FRONT SPEAKER JACK**
Connect the RIGHT FRONT SPEAKER to the RED jack.
- 15. RIGHT REAR SPEAKER JACK**
Connect the RIGHT REAR SPEAKER to the BLUE jack.
- 16. CENTER SPEAKER JACK**
Connect the CENTER SPEAKER to the YELLOW jack.
- 17. LEFT REAR SPEAKER JACK**
Connect the LEFT REAR SPEAKER to the GREEN jack.
- 18. LEFT FRONT SPEAKER JACK**
Connect the LEFT FRONT SPEAKER to the WHITE jack.
- 19. AUX INPUT JACK**
Connect to the audio out of other optional equipment.
- 20. GAME INPUT JACK**
Connect to the audio out of TV Game.
- 21. DVD INPUT JACK**
Connect to the audio out of DVD player.

FUNCTION CONTROL

(Continued)

REMOTE CONTROL

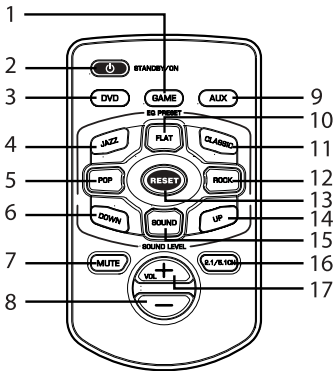

- 1. GAME button**
Press to select the GAME sound input source.
- 2. STANDBY/ON button**
Turns the unit ON, or puts the unit into STANDBY mode.
- 3. DVD button**
Press to select the DVD sound input source.
- 4. JAZZ button**
Press to select the JAZZ of equalization mode.
- 5. POP button**
Press to select the POP of equalization mode.
- 6. DOWN button**
Press to decrease the volume of individual speaker.
- 7. MUTE button**
Instantly turns off the sound. Press again to restore the sound.
- 8. VOLUME + / - button**
Adjust the volume and the level of all speakers.
- 9. AUX button**
Press to select the AUX sound input source.
- 10. FLAT button**
Press to select the FLAT of equalization mode.
- 11. CLASSIC button**
Press to select the CLASSIC of equalization mode.
- 12. ROCK button**
Press to select the ROCK of equalization mode.
- 13. RESET button**
Press to adjust all speakers to the normal level.
- 14. UP button**
Press to increase the volume of individual speaker.
- 15. SOUND button**
Press to select the speaker mode.
- 16. 2.1 / 5.1 CH button**
Press to select the listening mode in 2.1 or 5.1 channel.

USING THE REMOTE CONTROL CORRECTLY

- Point the Remote Control at the REMOTE SENSOR located on the unit.
- When there is a strong ambient light source, the performance of the infrared REMOTE SENSOR may be degraded, causing unreliable operation.
- The recommended effective distance for remote operation is about 6 meters (19 feet).

TO CHANGE REMOTE BATTERY

1. Open the battery door.

2. Insert one CR2025 (3V) size battery.

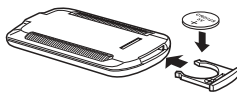

ATTENTION

Take out the PVC sheet before operating the Remote Control.

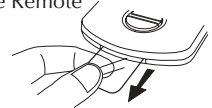

BATTERY REPLACEMENT

When battery become weak, the operating distance of the Remote Control is greatly reduced and you will need to replace the battery.

NOTE : If the Remote Control is not to be used for a long time, remove the battery to avoid damage caused by battery leakage corrosion.

WARNING : Do not dispose of batteries in fire, batteries may explode or leak.

CAUTION : Danger of explosion if battery is incorrectly replaced. Replace only with the same or equivalent type.

CONNECTIONS

POWER CONNECTION

Notes:

- Before you plug in the unit, make sure that the rated voltage of your unit matches your local voltage.
- Keep your hands dry when you are connecting the power cord to the wall outlet to avoid electric shock.
- When you are not going to use the unit for a long period of time, disconnect the power cord.
- When the player is in the standby mode, it is still consuming some power. If you wish to disconnect the unit completely from the power, unplug the power cord from the AC outlet.
- To prevent electric shock, match wide blade of plug to wide slot, fully insert. (For USA and Canada only)

CONNECTING THE SPEAKERS & SUBWOOFER

IMPORTANT : Switch off the power before connecting equipment.

The speaker cords have been color-coded to simplify connection. Just plug the speaker wire into the corresponding jacks on the rear of the unit, matching the color tube on the end of the speaker wire to the color-coded connector.

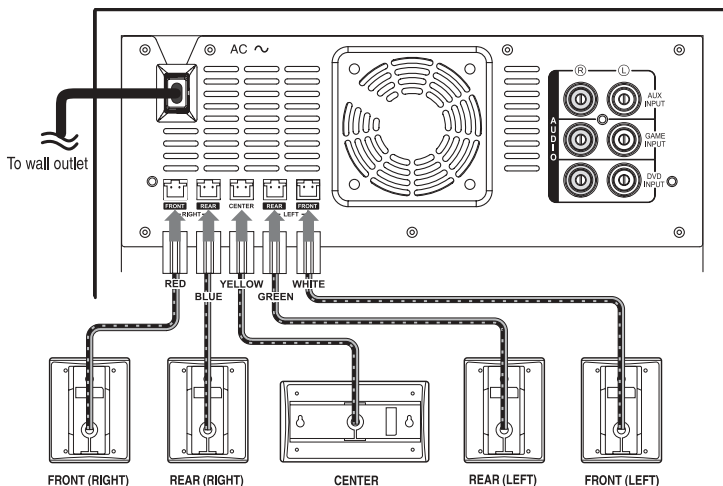

Caution:

- To prevent damage to the unit, be sure to turn off the unit before making any connection.
- Connecting speakers other than the speakers supplied with the unit may damage the unit.

MOUNTING THE REAR SURROUND SPEAKERS

1. Mark the correct mounting position on the wall.
2. Insert a fixing screw(s) at the marked position on the wall.
3. Align the slot hole(s) of the speaker over the screw and pull the speaker downward until it is firmly hooked.

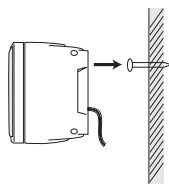

POSITIONING THE SPEAKERS & SUBWOOFER

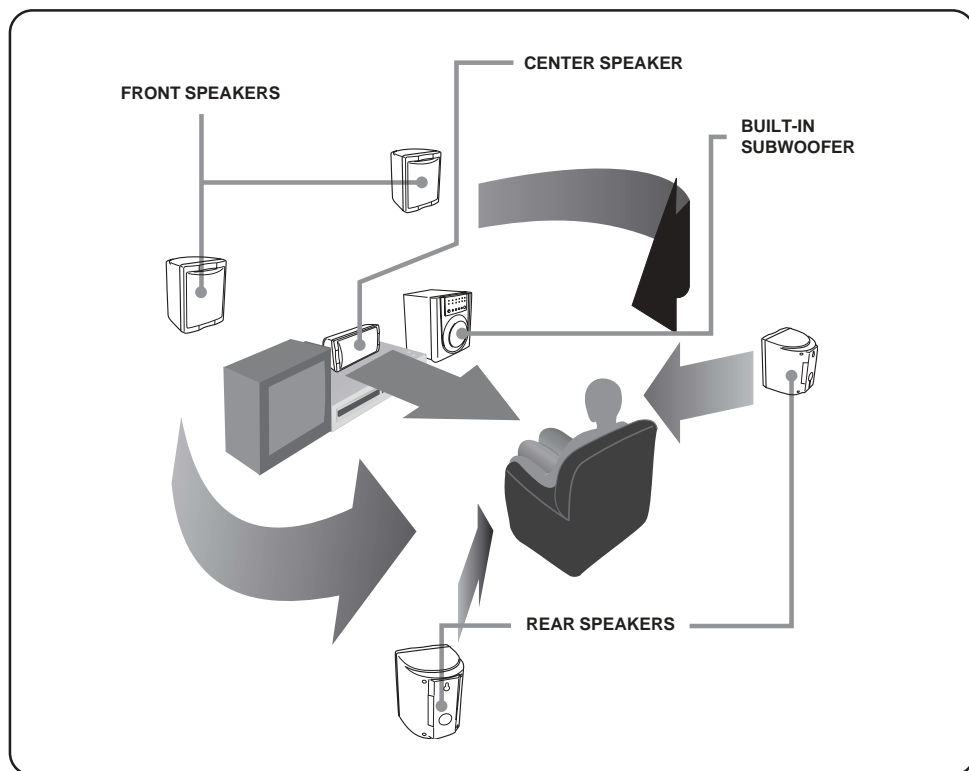

FRONT SPEAKERS

Place the front speakers on both sides of the TV, equal distances apart.

CENTER SPEAKER

Place the center speaker on the top of or below the TV.

BUILT-IN SUBWOOFER

Place the subwoofer on the floor near the TV or in any corner.

REAR SPEAKERS

Place the rear speakers on right beside or slightly behind your listening position, and a little higher than your ears.

Note : All speakers must be visible. Do not hide them behind curtains, furniture, etc, as this will affect the sound.

CONNECTIONS

(Continued)

IMPORTANT : Switch off the power before connecting equipment.

CONNECTION WITH TV (if your TV has Audio Output jacks)

- Connect the audio cable to the white jack of AUX INPUT (L) and red jack of AUX INPUT (R) on the unit, and then connect to the corresponding AUDIO OUT jacks on your TV. This will allow your TV's sound to play through the unit.
- Press the **STANDBY/ON** button on the unit or on the remote control.
- Press the **INPUT SOURCE** button until the AUX indicator lights.

CONNECTION WITH TV GAME

- Connect the audio cable to the white jack of GAME INPUT (L) and red jack of GAME INPUT (R) on the unit, and then connect to the corresponding AUDIO OUT jacks on your TV GAME. This will allow your TV GAME's sound to play through the unit.
- Press the **STANDBY/ON** button on the unit or on the remote control.
- Press the **INPUT SOURCE** button until the GAME indicator lights.

Note : Connect your TV GAME's video cable to your TV's video input jack directly.
Make sure your TV GAME is on and refer to your TV GAME's owner's manual.

CONNECTION WITH DVD player

- Connect the audio cable to the white jack of DVD INPUT (L) and red jack of DVD INPUT (R) on the unit, and then connect to the corresponding AUDIO OUT jacks on your DVD player. This will allow your DVD player's sound to play through the unit.
- Press the **STANDBY/ON** button on the unit or on the remote control.
- Press the **INPUT SOURCE** button until the DVD indicator lights.

Note : Connect your DVD player's video cable to your TV's video input jack directly.
Make sure your DVD player is on and refer to your DVD player's owner's manual.

CONNECTION WITH VCR

- Connect the audio cable to the white jack of AUX INPUT (L) and red jack of AUX INPUT (R) on the unit, and then connect to the corresponding AUDIO OUT jacks on your VCR. This will allow your VCR's sound to play through the unit.
- Press the **STANDBY/ON** button on the unit or on the remote control.
- Press the **INPUT SOURCE** button until the AUX indicator lights.

Note : Connect your VCR's video cable to your TV's video input jack directly.
Make sure your VCR is on and refer to your VCR's owner's manual.

CONNECTION WITH OTHER EQUIPMENT

- Connect the audio cable to the white jack of AUX INPUT (L) and red jack of AUX INPUT (R) on the unit, and then connect to the corresponding AUDIO OUT jacks on your equipment. This will allow your equipment's sound to play through the unit.
- Press the **STANDBY/ON** button on the unit or on the remote control.
- Press the **INPUT SOURCE** button until the AUX indicator lights.

Note : Make sure your equipment is on and refer to your equipment's owner's manual (CD player, Radio etc.)

If your CD player, radio with 3.5mm stereo jack, you may use the green 3.5mm plug and cable to connect this home theater system.

DIAGRAM OF SET UP, PLEASE SEE PAGE 9.

CONNECTIONS

(Continued)

SET UP DIAGRAM

IMPORTANT : Switch off the power before connecting equipment.

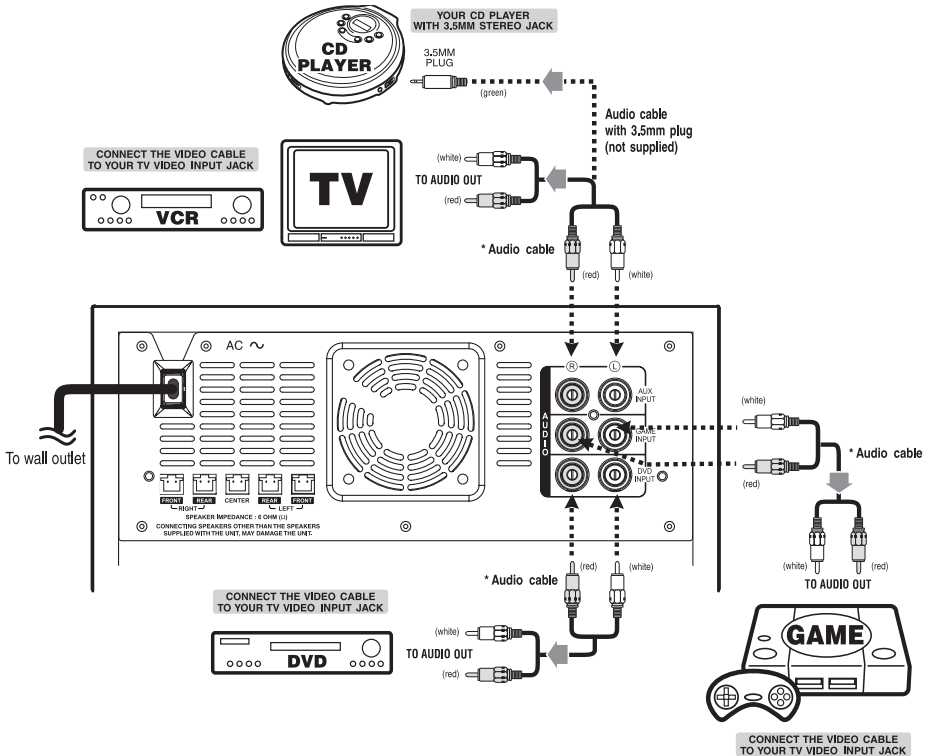

NOTE : This system improves the sound of your DVD player, VCR or TV game, please connect the video cable directly to your TV video input jack.

* One set of Audio Cable (Red & White) is supplied.

SOUND ADJUSTMENT

TO ADJUST THE MASTER VOLUME

- Press the **VOLUME +/-** button on the unit or on the remote control to adjust the volume of all speakers.

TO ADJUST THE VOLUME OF INDIVIDUAL SPEAKER

- Press the **SOUND** button on the remote control to select the speaker sound mode when the indicator will light.
- Press **UP** or **DOWN** buttons on the remote control to increase or decrease the volume.

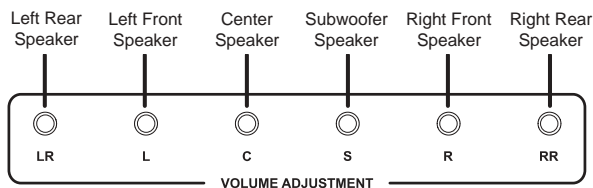

TO CHANGE THE PRESET EQUALIZER

- Press the **EQ PRESET** buttons on the remote control to select an equalization mode (POP, JAZZ, FLAT, CLASSIC, ROCK).

POP : More presence of vocals and mid range.
ROCK : Emphasizes the mid range and bass sounds.
JAZZ : Emphasizes the mid range sounds.
CLASSIC : Equalizer off
FLAT : Natural (no effect is added)

TO CHANGE THE SPEAKER CHANNEL

- Press the **SPEAKER CHANNELS** button on the unit or **2.1/5.1 CH** button on the remote control to select the listening mode.
- When the 5.1 channel indicator lights, the sound will come out of 5 speakers plus the subwoofer. When the 2.1 channel indicator lights, the sound will come out of 2 front speakers plus the subwoofer.

NOTE : Rear speakers and center speaker volume adjustments can only be made from the remote control in 5.1 channel speaker mode, not in 2.1 channel speaker mode.

NOTE : Press the **MUTE** button to turns off the sound instantly. Press again to restore the sound.

TROUBLE SHOOTING GUIDE

The following checks will assist in the correction of most problems which you may encounter with your system.

PROBLEMS	SOLUTIONS
No power.	<ul style="list-style-type: none"> • Check that the AC power cord is connected.
No sound.	<ul style="list-style-type: none"> • Press the VOLUME + button to increase volume. • Ensure the MUTE button is not pressed on the remote control. • Ensure the INPUT SOURCE selection is correct.
No sound from one channel or unbalanced left and right volume.	<ul style="list-style-type: none"> • Check the speaker connections of the inoperative channel. • Check the speaker cord connection and speaker location. • Adjust individual speaker volumes (see page 10).
Reversed left and right sound.	<ul style="list-style-type: none"> • Check the speaker connection for proper phasing.
The centre speaker or the surround speakers give no sound	<ul style="list-style-type: none"> • Check that the speaker connections are correct. • The current mode does not support surround sound.
The remote control does not function.	<ul style="list-style-type: none"> • Remove any obstacles between the remote control and the unit. • Use the remote control near the unit. • Point the remote control at the remote sensor on the unit. • Replace the battery in the remote control with new one. • If there is a clear plastic strip sticking out from the rear of the remote control, pull it out.

OPERATING VOLTAGE

Power consumption : 60W
 Power requirements : AC ~ 100V 50/60Hz (Japan)
 AC ~ 110V/120 - 220/240 50/60Hz (Other countries)
 AC ~ 120V 60Hz (USA and Canada)
 AC ~ 220V 50Hz (Hong Kong and China)
 AC ~ 230-240V 50Hz (Europe)
 AC ~ 240V 50Hz (Australia)

Specifications and external appearance are subject to change without advance notice due to continuous product improvement.