

SAMSUNG

MICRO COMPONENT SYSTEM

MP3-CD/WMA-CD/CD-R/RW PLAYBACK

MM-T6

Instruction Manual

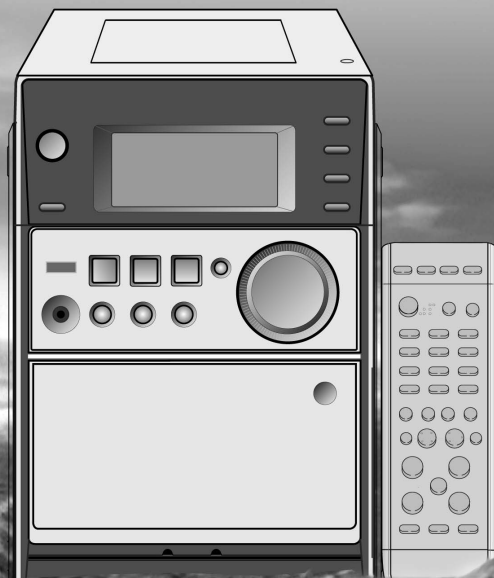

CLASS 1 LASER PRODUCT
KLASSE 1 LASER PRODUKT
LUOKAN 1 LASER LAITE
KLASS 1 LASER APPARAT
PRODUCTO LASER CLASE 1



CAUTION

RISK OF ELECTRIC SHOCK.
DO NOT OPEN



CAUTION:
 TO REDUCE THE RISK OF ELECTRIC SHOCK,
 DO NOT REMOVE REAR COVER.
 NO USER SERVICEABLE PARTS INSIDE.
 REFER SERVICING TO QUALIFIED SERVICE
 PERSONNEL.



This symbol indicates that dangerous voltage which can cause electric shock is present inside this unit.



This symbol alerts you to important operating and maintenance instructions accompanying the unit.

CLASS 1 LASER PRODUCT

This Compact Disc player is classified as a CLASS 1 LASER product.

Use of controls adjustments or performance of procedures other than those specified herein may result in hazardous radiation exposure.

CAUTION-INVISIBLE LASER RADIATION WHEN OPEN AND INTER LOCKS DEFEATED, AVOID EXPOSURE TO BEAM.

WARNING: TO REDUCE THE RISK OF FIRE OR ELECTRIC SHOCK, DO NOT EXPOSE THIS APPLIANCE TO RAIN OR MOISTURE.

CAUTION: TO PREVENT ELECTRIC SHOCK, MATCH WIDE BLADE OF PLUG TO WIDE SLOT, FULLY INSERT.

Thank you for buying this SAMSUNG micro-component system.

Please take time to read these instructions. They will allow you to operate your system with ease and take full advantage of its features.

- ◆ SAFETY WARNINGS 2
- ◆ INSTALLING YOUR MICRO-COMPONENT SYSTEM 4
 - Front Panel View 4
 - Remote Control 5
 - Rear Panel View 6
 - Where to Install your Micro-Component System 7
 - Connecting your System to the Power Supply 7
 - Inserting Remote Control Batteries 7
 - Connecting to an External Source 8
 - Speaker Connection 8
 - Connecting the AM (MW) Aerial 9
 - Connecting the FM Aerial 9
 - Demo/Dimmer Function 10
 - Setting the Clock 10
- ◆ CD-PLAYER 10
 - To replay the CD/MP3-CD 10
 - Regarding the playback of CD-R/RW 11
 - Selecting a Track 11
 - Selecting the MP3-CD album and track 11
 - Searching for a Specific Music Passage on a CD 12
 - Function to skip through 10 tracks at a time 12
 - Last Memory Function 12
 - Repeating One or All Tracks on the Compact Discs 13
 - Repeat A ↔ B Function 13
 - Programming the Order of Playback 13
 - Checking or Changing Programmed Tracks 14
- ◆ TUNER 14
 - Searching for and Storing the Radio Stations 14
 - Selecting a Stored Station 15
 - Improving Radio Reception 15
- ◆ USING USB 16
 - Playing USB 16
 - Selecting a Track from USB Device 16
 - To skip next 10 tracks 16
 - To use high speed search 16
 - To repeat 17
 - To repeat section 17
 - To use Last Memory function 17
- ◆ TAPE DECK 18
 - Listening to a Cassette 18
 - Recording a Compact Disc 18
 - Recording a Radio Program 18
- ◆ OTHER FUNCTIONS 19
 - Timer Function 19
 - Cancelling the Timer 19
 - Power Sound Function 20
 - EQ/S.BASS (Super Bass) Function 20
 - Selecting the Cassette Playback Mode 20
 - Shuffle Play Function 20
 - Sleep Timer 21
 - MUTE Function 21
 - Connecting Headphones 21
 - Microphone Function(option) 21
 - Tape Counter 21
- ◆ RECOMMENDATIONS FOR USE 22
 - Safety Precautions 22
 - Cleaning your Micro-Component System 22
 - Precautions When Using Compact Discs 23
 - Precautions When Using Audio Cassettes 23
 - Before Contacting the After-Sales Service 23
 - Technical Specifications 24



Symbols



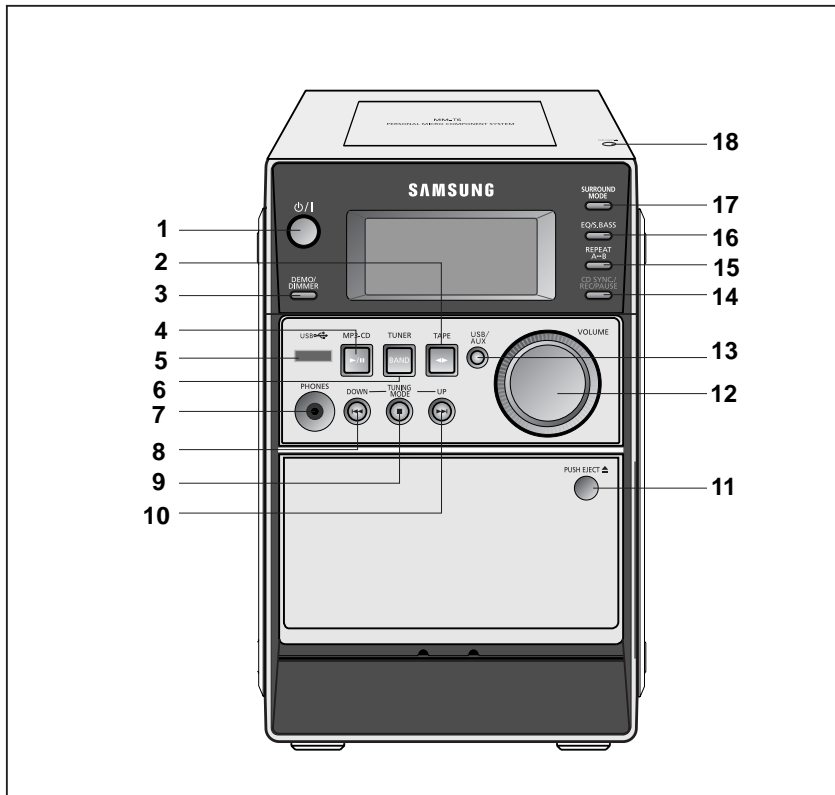

- | | |
|----------------------------|------------------------------------|
| 1. STANDBY/ON | 11. PUSH EJECT |
| 2. TAPE PLAY | (CASSETTE DOOR OPEN/CLOSE) |
| 3. DEMO/DIMMER | 12. VOLUME CONTROL |
| 4. MP3-CD PLAY/PAUSE | 13. USB/AUX |
| 5. USB JACK | 14. CD SYNC./REC/PAUSE |
| 6. TUNER / BAND | 15. CD / TAPE /USB REPEAT A ↔ B |
| 7. HEADPHONE JACK | 16. EQ/SUPER BASS |
| 8. SKIP OR SEARCH REWIND | 17. POWER SOUND |
| 9. STOP/TUNING MODE | 18. PUSH EJECT(CD DOOR OPEN/CLOSE) |
| 10. SKIP OR SEARCH FORWARD | |

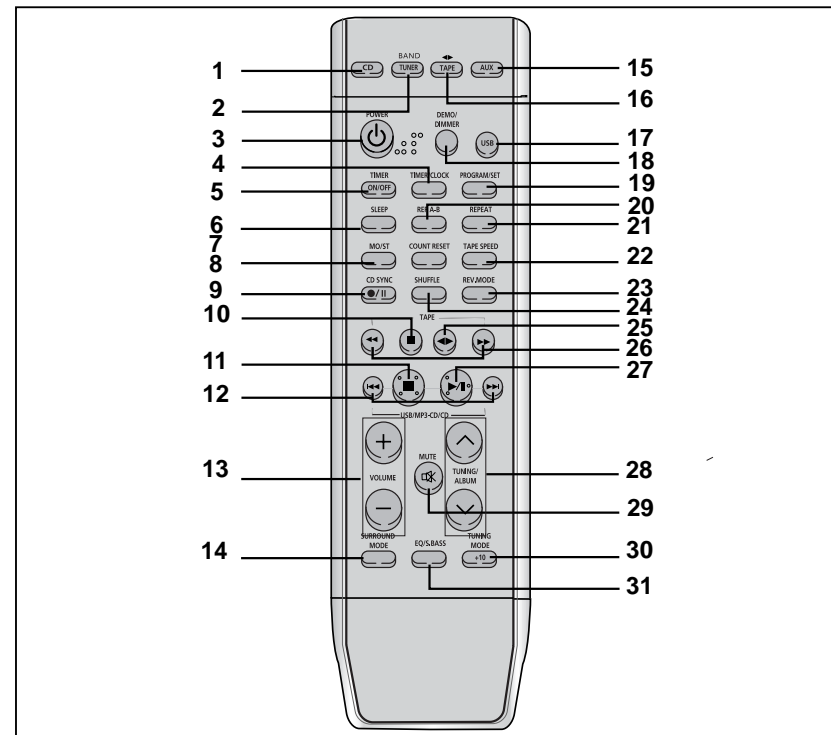

- | | |
|----------------------------------|--|
| 1. CD FUNCTION | 17. USB FUNCTION |
| 2. TUNER FUNCTION | 18. DIMMER/DEMO |
| 3. POWER | 19. PROGRAM / SET |
| 4. TIMER/CLOCK | 20. REPEAT A-B |
| 5. TIMER ON/OFF | 21. REPEAT |
| 6. SLEEP | 22. TAPE SPEED |
| 7. COUNTER RESET | 23. REVERSE MODE |
| 8. FM MONO/STEREO | 24. SHUFFLE |
| 9. CD SYNC./REC/PAUSE | 25. TAPE PLAY |
| 10. TAPE STOP | 26. TAPE REWIND/FAST-FORWARD |
| 11. USB/MP3-CD/CD STOP | 27. USB/CD PLAY/PAUSE |
| 12. USB/MP3-CD/CD SKIP OR SEARCH | 28. TUNING UP OR DOWN SEARCH/
MP3-CD/USB ALBUM SELECT |
| 13. VOLUME CONTROL | 29. MUTE |
| 14. SURROUND MODE | 30. TUNING MODE / +10 |
| 15. AUX FUNCTION | 31. EQ/SUPER BASS |
| 16. TAPE FUNCTION | |

Rear Panel View

GB

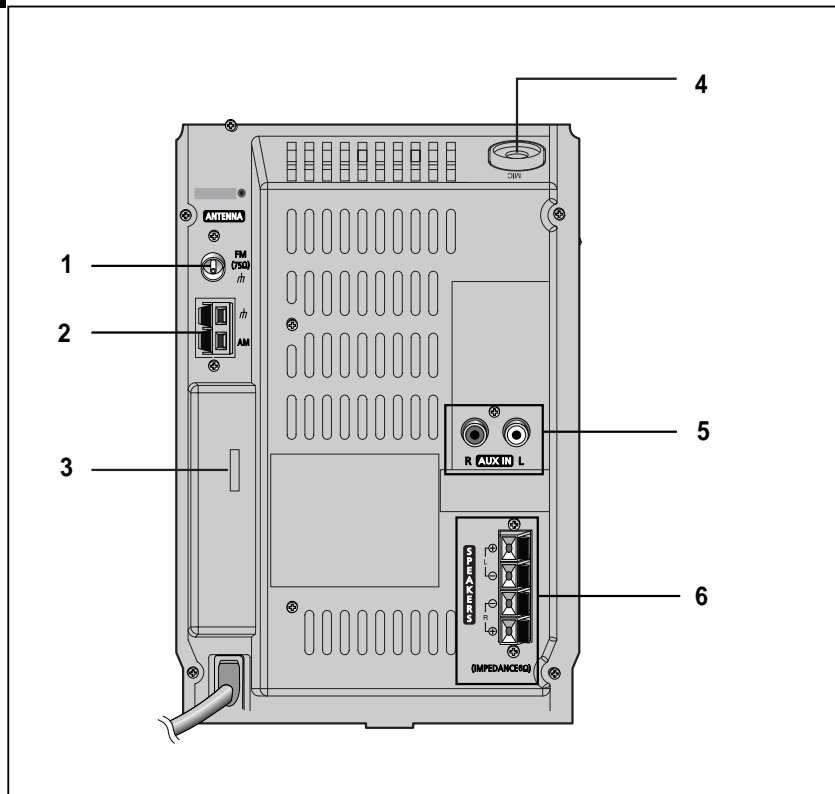

1. FM Aerial Connector Terminal
2. AM Aerial Connector Terminals
3. Voltage selector (option)
4. Microphone Jack (option)
5. AUX-Input
6. Loudspeakers Connector Terminals

Where to Install Your Micro-Component System

To take full advantage of your new micro-component system, follow these installation instructions before connecting the unit.

- ◆ Install the system on a flat, stable surface.
- ◆ Never place this unit on carpeting.
- ◆ Never place this unit in an outdoor area.
- ◆ Maintain an open space of approximately 6 inches (15 cm) on the sides and rear of the system, for ventilation purposes.
- ◆ Make sure that you have enough room to open the compact disc compartment easily.
- ◆ Place the loudspeakers at a reasonable distance on either side of the system to ensure good stereo sound.
- ◆ Direct the loudspeakers towards the listening area.
- ◆ For optimum performance, make sure that both speakers are placed at an equal distance above the floor.



Connecting your System to the Power Supply

The main lead must be plugged into an appropriate socket.

Before plugging your system into a main socket, you must check the voltage setting (OPTIONAL). If the voltage of the socket does not correspond to the setting on the rear of the unit, you may seriously damage your system.

- 1 Plug the main lead into an appropriate socket.
- 2 Press the **STANDBY/ON** button to switch your micro-component system on.

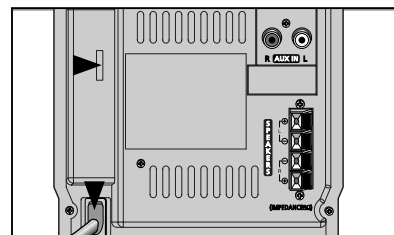

Inserting Remote Control Batteries

GB

Insert or replace remote control batteries when you:

- ◆ Purchase the micro-component system
- ◆ Find that the remote control is no longer operating correctly

When replacing the batteries, use a new set of batteries and never mix alkaline and manganese batteries.

- 1 Place your thumb on the position marked Δ on the battery compartment cover (rear of the remote control) and pull the cover in the direction of the arrow.
- 2 Insert two AAA, LR03 or equivalent batteries, taking care to respect the polarities:
 - ◆ + on the battery against + in the battery compartment
 - ◆ - on the battery against - in the battery compartment
- 3 Replace the cover by sliding it back until it clicks into position.

➤ If you will not be using the remote control for a long time, remove the batteries to prevent corrosion.

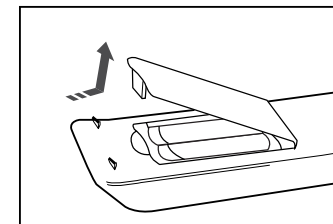

Connecting to an External Source

The auxiliary input can be used to take advantage of the sound quality of your micro-component system when listening to other sources.

- Examples:
- ◆ A television
 - ◆ A video disc player
 - ◆ A Hi-Fi stereo video cassette recorder

➤ To connect to the external source, the source must have an audio output. In addition, you need an RCA connection cable.

- 1 Set the system to standby mode and disconnect it and the external source from the main socket.
- 2 Connect the audio cable to the rear of the micro-component system.
Connect the... To the connector marked...
Red jack..... R (right)
White jack..... L (left)
➤ For optimum sound quality, do not invert the right and left channels.
- 3 Plug the system back into the main socket and press **Standby/On** (⏻ / ⏻) to switch it on.
- 4 Select the **AUX** source by pressing **AUX**.
Result: **AUX** is displayed.
- 5 Switch the external source on.
- 6 Adjust the volume and balance as required:
◆ Volume ◆ Equaliser

Example: You can watch a film and take advantage of stereo sound provided that the original sound track is in stereo (as if you were in a cinema).

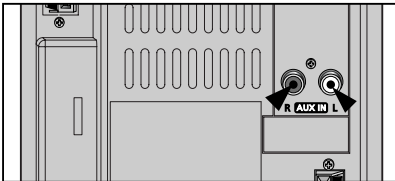

Speaker Connection

The loudspeaker connector terminals are located on the rear of the system (red and black tabs).

There are four terminals on the system:

- ◆ Two for the left speaker (marked L)
- ◆ Two for the right speaker (marked R)

To achieve the correct sound quality, connect the:

- ◆ Red wire to the + terminals
- ◆ Black wire to the - terminals

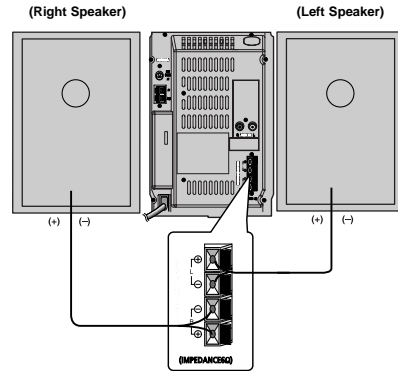

Directions in Installing Speaker

- ◆ Installation in a place near heating apparatus, under direct lay of light or with high humidity may cause performance degradation of the speaker.
- ◆ Do not install on the wall or on a high place of pole or other unstable place to prevent any safety accident caused by falling of the speaker.
- ◆ Do not take the speaker apart from TV or computer monitor. The speaker near the TV or computer monitor may influence the quality of the screen display.

Connecting the AM (MW) Aerial

The AM aerial (for long and medium waves) can be:

- ◆ Placed on a stable surface
- ◆ Fixed to the wall (you must first remove the base)

The AM aerial connector terminals are located on the rear of the system and are marked AM.

- To avoid noise interference, check that the loudspeaker wires do not run close to the aerial wires. Always keep them at least 2 inches (5 cm) away.

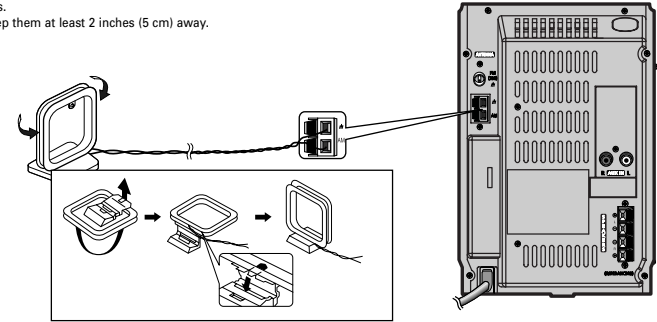

Connecting the FM Aerial

How to connect a COAXIAL TYPE aerial.

- ◆ Connect a 75Ω antenna to the FM antenna terminal.
- ◆ Plug the connector on the FM aerial supplied into the coaxial socket (75Ω) marked FM on the rear of the system.
- ◆ Follow the instructions given on **Page 14** to tune into a radio station, and determine the best position for the aerial.
- ◆ If reception is poor, you may need to install an outdoor aerial. To do so, connect an outdoor FM aerial to the FM socket on the rear of the system using a 75Ω coaxial cable (not supplied).

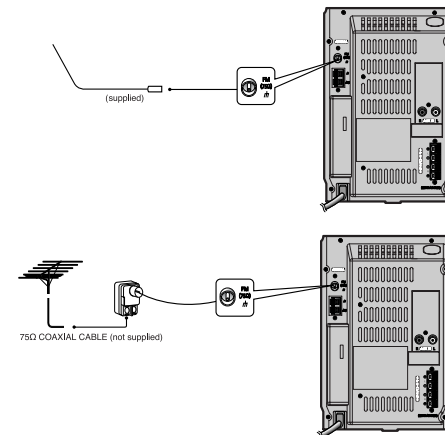

Demo/Dimmer Function

All functions available on the system can be viewed on the display and the display's brightness can be switched between "on" and "off".

- Press the **DEMO/DIMMER** button.
Result: All functions available on the system appear on the front panel display.
 - Each of these are explained in detail in this guide. Please refer to the relevant section.
 - Press the **DEMO/DIMMER** button again.
Result: The Dimmer function is selected and the display darkens.
 - Press the **DEMO/DIMMER** button once again to brighten the front panel display.
- A display brightness control can only be performed while the system power is on.



Setting the Clock

our system is equipped with a clock which allows you to turn your system on and off automatically.

You should set the clock:

- When you first purchase the micro-component system
- After a power failure
- After unplugging the unit

➤ For each step, you have a few seconds to set the required options. If you exceed this time, you must start again.

- Switch the system on by pressing **Standby/On** ($\phi/1$)
- Press **TIMER/CLOCK** twice.
Result: CLOCK is displayed.
- Press **PROGRAM /SET**.
Result: The hour flashes.
- To... Press...
Decrease the hours \downarrow
Increase the hours \uparrow
- When the correct hour is displayed, press **PROGRAM /SET**.
Result: The minutes flash.
- To... Press...
Decrease the minutes \downarrow
Increase the minutes \uparrow
- When the correct time is displayed, press **PROGRAM /SET**.
Result: The clock starts and is displayed, even when the system is in standby mode.

➤ You can display the time, even when you are using another function, by pressing **TIMER /CLOCK** once.

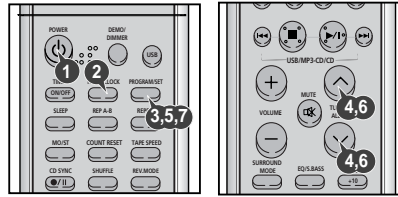

To replay the CD/MP3-CD/WMA-CD

This unit has been designed to playback the CDs: Audio CD, CD Text, CD-R, CD-RW, MP3-CD and WMA-CD.

Continued use of irregular shape CDs (heart-shape, octagonal, etc.) can damage the unit.

- Select the CD function by pressing **MP3-CD** ($\triangleright/||$) button.
- Press the **PUSH EJECT** (\blacktriangle) button.
Result: The compartment opens.
- Place your disc in the compartment, with the label on the disc facing upwards.
- Close the compartment by pressing the **PUSH EJECT** (\blacktriangle) button again until it clicks into place.
- Press the **MP3-CD** ($\triangleright/||$) button.
 - Your CD Player will take a few moments to scan through all the tracks recorded on a particular MP3-CD
 - The English name of the song may be indicated on the display only if directly downloaded from the PC or if the purchased MP3-CD is sorted according to titles(directory). (Other languages besides English may not be indicated.)
 - The English name of the track may not be indicated depending on the characteristics of the MP3-CD.
- To stop playback temporarily, press the **MP3-CD** ($\triangleright/||$) button.
 - Press **MP3-CD** ($\triangleright/||$) again to continue playing the disc.
- Press the **STOP** (\blacksquare) button when you have finished.

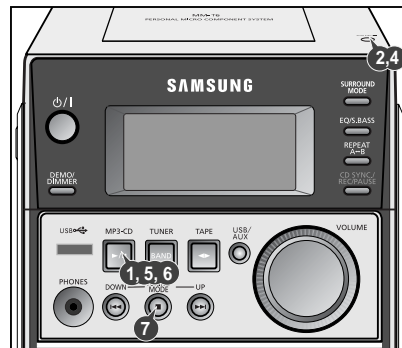

Regarding the playback of CD-R/RW

- In the case of an original CD-R(Recordable) recorded in audio CD format, CD-RW(Rewritable) and editing by the user, playback is processed on the respective completed status. (The player may not be played back according to the characteristics of the CD or recorded status.)
- The CD-RW is comparably less reflexive than CD which causes more time delay to read.

Selecting a Track

You can select the track you wish to listen to, either when the compact disc player is stopped or when a disc is playing.

To start playback at the beginning of the...	Press...
Next track	$\triangleright/ $ once
Current track	\lll once
Previous track	\lll twice
Track of your choice	\lll or $\triangleright/ $ the appropriate number of times.

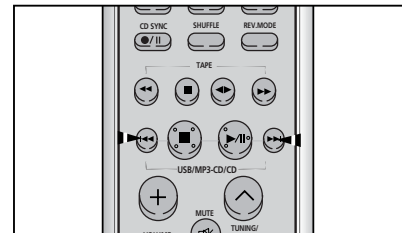

Selecting the MP3-CD album and track

The album and track of the MP3-CD desired to listen may be selected on stopping or during playbacks.

- You can select the album by pressing **TUNING/ALBUM** button on the remote control.
Result: ALBUM is displayed.
- To move the album, press the \downarrow or \uparrow button.

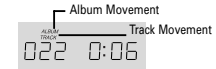

- To move the track, press the \lll $\triangleright/||$ button.
Result: TRACK is displayed and the track number is moved.

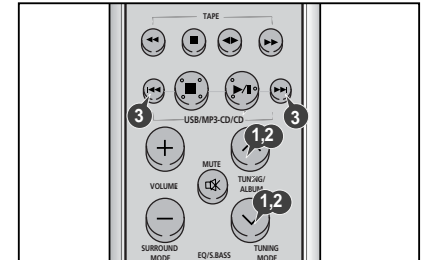

What is WMA?

WMA means Windows Media Audio, the global standard for audio signal compression technology.

What is MP3?

MP3 means MPEG1 Layer 3, the global standard for audio signal compression technology. It uses digital compression technology to compress original sound data by up to 12 times without sound quality degradation.

File Compatibility

◆ The unit will playback files created in MP3 format (Mpeg1.Layer3) with *.mp3 as their extension, and WMA files with.WMA extension can be playback.

◆ Playback will be impossible for the file of MP2 or 22KHz.

◆ ID3*tags can be shown on the display in English. *An MP3 file can contain file information called "ID3 Tag" where its album name, performer, rack title, etc. are recorded.

How many MP3 files can a CD-R or CD-RW disc record?

The maximum capacity of one CD-R or CD-RW disc is 680MB.

Normally, one MP3 file has a capacity of 4MB, therefore approximately 170 files can be recorded on a single disc.

Playback sequence of albums and tracks

- ◆ In case of Window Explorer display.
- ◆ The arrows indicates playback sequence of albums and tracks.
- ◆ Tracks with jpg, wav or doc only are not audio files and therefore will be skipped.

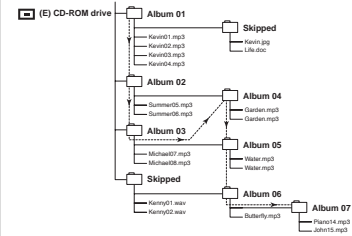

Searching for a Specific Music Passage on a CD

When listening to a compact disc, you can quickly search for a specific music passage on a track.

To search through the tracks... Press and hold down...

Forwards for at least one second

Backwards for at least one second

➤ It is recommended that you turn the volume down before using this function.



Function to skip through 10 tracks at a time

Press the **+10** button briefly while playing back a CD. The track 10 tracks after the current one will then be played back.

Example: If you want to select track 43 during playback of track 15, press the **+10** button three times, and then press the **▶▶** button three times.

15 → 20 → 30 → 40 → 41 → 42 → 43

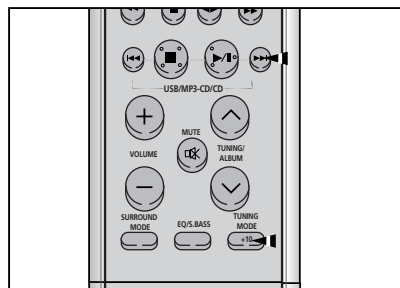

Last Memory Function

When MP3-CD playback is selected again after your CD player has been stopped or turned off, this function allows playback from the start of the track that you last listened to.

◆ Press the **PROGRAM/SET** button while your MP3-CD is being played. The **LAST ON** and **LAST OFF** may be repeatedly selected.

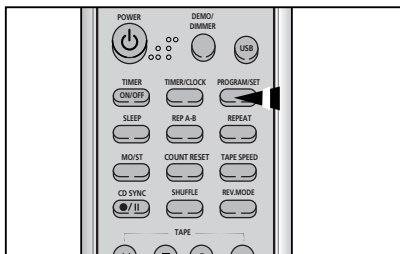

Repeating One or All Tracks on the Compact Discs

You can repeat indefinitely:

- ◆ A specific track on a compact disc.
- ◆ All tracks on the compact disc selected.

1 To repeat... Press Repeat on the remote control one or more times until...

The current track indefinitelyREPEAT 1 is displayed
All songsREPEAT ALL is displayed

2 When you wish to stop the Repeat function, press **REPEAT** button.
Result:REPEAT is no longer displayed and the function is cancelled.

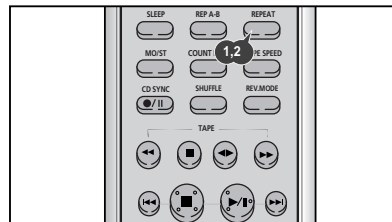

REPEAT A-B Function

(This function is not available during playback of a MP3-CD.)

When you select CD(TAPE) REPEAT A ↔ B playback, the music passages to which you were listening are repeated 3 times.

1 Press MP3-CD (▶||) or TAPE button.
Result:The CD(TAPE) player starts playing.

2 Press REPEAT A ↔ B button.
Result:The indications appear: **START**

The flashes appear: A ↔

◆ A Time is memorised.

3 Press REPEAT A ↔ B button.
Result:The indications appear: **END**

◆ B Time is memorised.

◆ Your selected passages are repeated 3 times.

4 When you have finished the Repeat playback, Press REPEAT A ↔ B.

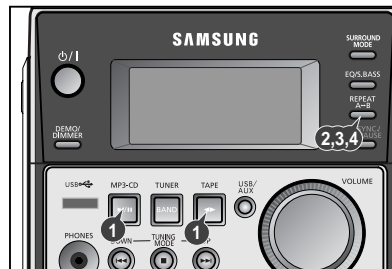

Programming the Order of Playback

(This function is only available during playback of a CD.)

You can decide for yourself:

- ◆ The order in which you listen to the tracks
- ◆ The tracks to which you do not wish to listen

➤ This feature can be combined with the CD Repeat function.

1 If necessary, stop the player by pressing **STOP** (■).

2 Press **PROGRAM / SET**.

Result: **PRO1** -- is displayed.

3 Select the required track by pressing the SKIP buttons:

- ◆ ▶▶ to move forwards through the tracks
- ◆ ◀◀ to move backwards through the tracks

4 Press **PROGRAM / SET**.

Result: **PRO2** -- is displayed.

5 To select other tracks, repeat Steps 3 and 4.

➤ You can programme up to 24 tracks.

6 When you have finished selecting the tracks, press **MP3-CD** (▶||) to start listening to the selection, in the order in which the tracks were programmed.

7 Press **STOP** (■) twice to cancel the selection when the disc is playing.

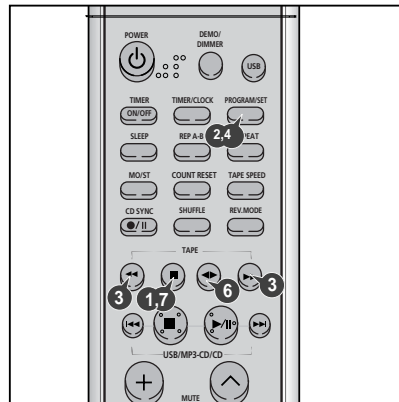

Checking and Changing Programmed Tracks

GB You can check and change your selection of tracks at any time.

GB You must have selected at least one track.

- 1 Press **STOP** (■) once if you have started listening to the selection.
- 2 Press **PROGRAM / SET**.
➤ Each time you press Program/Set, the next selection is displayed.
- 3 Press **PROGRAM / SET** one or more times until the track to be changed is displayed.

TRACK 01
PROGRAM 01

- 4 Press **◀▶** to select the new track.
- 5 Press **PROGRAM / SET**.
- 6 Press **MP3-CD** (▶/||) to start listening to the selection.
Result: The first track selected is played.

➤ You can change one or more tracks in your initial selection

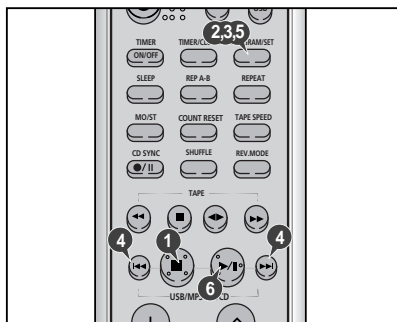

Searching for and Storing the Radio Stations

You can store up to:

- ♦ 15 FM stations
- ♦ 15 MW station

- 1 Switch the system on by pressing **Standby/On** (⏻/|).
- 2 Select the **TUNER** function by pressing **TUNER/BAND**.
- 3 Select the required frequency band by pressing **TUNER/BAND** again.
Result: The appropriate indication is displayed:
♦ **FM** Frequency Modulation
♦ **AM(MW)** Medium Wave

4 To search for a station ... Press Tuning Mode ...

Manually.....One or more times until **MANUAL** is displayed.

Automatically.....One or more times until **AUTO** is displayed.

- 5 Select the station to be stored by pressing **◀▶** on the front panel to decrease or increase the frequency respectively.
 - ♦ To scroll through the frequencies faster when searching manually, hold down the **◀▶** on the front panel.
 - ♦ The automatic search procedure may stop on a frequency that does not correspond to a radio station. If this happens, use the manual search mode.
- 6 Adjust the volume by:
 - ♦ Turning the **VOLUME** knob on the front panel or
 - ♦ Pressing the **VOLUME+**, **-** button on the remote control.
- 7 Select the **FM** stereo or mono mode by pressing **MO/ST** on the remote control.

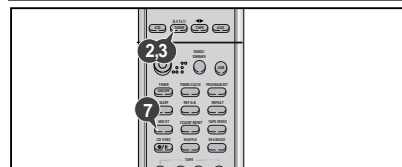
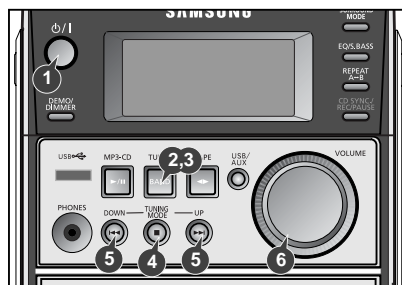

Searching for and Storing the Radio Stations(continued)

- 8 If you do not want to store the radio station found, revert to Step 4 and search for another station.

Otherwise:

- a Press **PROGRAM/SET**.
Result: The program number is displayed for a few seconds.
- b Press **TUNING** ∇ and ∆ to assign a program number between 1 and 15.
- c Press **PROGRAM/SET** to store the radio station.
Result: The program number is no longer displayed and the station is stored.

- 9 To store any other radio frequencies required, repeat Steps 3 to 6.

➤ The **PROGRAM** function can be used to assign a new station to an existing program number.

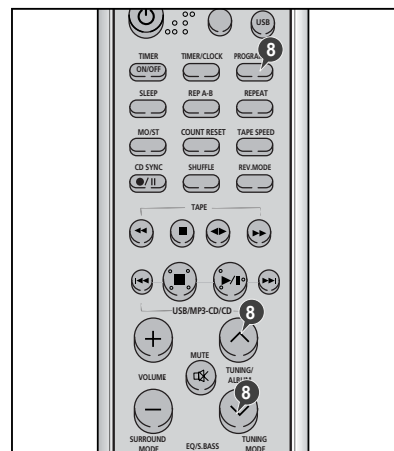

Selecting a Stored Station

GB You can listen to a stored radio station as follows:

- 1 Switch the system on by pressing **Standby/On** (⏻/|).
- 2 Select the **TUNER** function by pressing **TUNER**.
- 3 Select the required frequency band by pressing **TUNER**.
- 4 Select the radio station as follows.

To listen to ... Press ...

A stored station..... a Press the **TUNING MODE** button until **"PRESET"** is displayed.

b **TUNING** ∇ and ∆ to select the required station.

➤ Press **TUNING MODE** again to exit the stored station selection function.

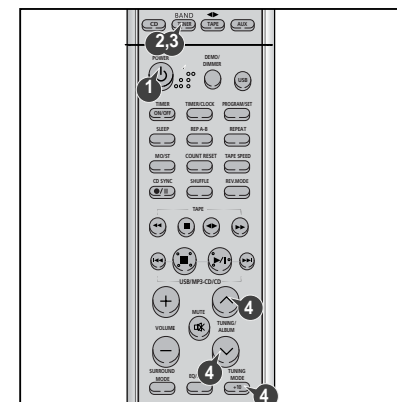

Improving Radio Reception

You can improve the quality of radio reception by:

- ♦ Rotating the **FM** or **AM(MW)** aerial
 - ♦ Testing the positions of the **FM** and **AM(MW)** aerials before fixing them permanently
- If reception from a specific FM radio station is poor, press **MO/ST** to switch from stereo mode to mono. The quality of the sound will be improved.

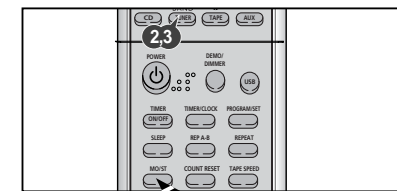

Playing USB

You can play MP3 files by connecting to various external USB storage devices such as USB flash memory or HDD. time.

- 1 Connect the external USB storage device to your player.
 - 2 Select USB function by using the **USB/AUX** button.
 - ◆ The first track of the first directory plays automatically.
- **To stop playing**
Press the Stop (■) button to stop playing.
◆ Press the Stop (■) button once to stop.



⚠ Do not connect USB charging device to the USB connection port of the player, because it may cause damage to the product.

Please be aware of the followings before using USB.

- ◆ Depending on the type of external USB storage device, it may not work even if it's connected to the player.
- ◆ With external HDD, FAT format can be played, but not NTFS format.
- ◆ With USB 2.0 HDD, connect to a separate power source. If it's not connected to a separate power source, it may not work.
- ◆ If memory of an external USB storage device is segmented into several parts, MP3 files of only the first hard disk drive can be played.
- ◆ Regarding directories, up to fourth directory can be played.
- ◆ DRM applied files are not played.
Digital Rights Management: Technology and service that protect the profit and rights of copyright owners by disallowing unauthorized use of digital contents.
- ◆ Even if the file name ends with .mp3, the file does not play if actual file format is MPEG layer 1 or 2.
- ◆ Disconnect the external USB storage device only in safe removal mode("USB REMOVE" display ON/OFF). Otherwise, internal file can be damaged.
Press the Stop (■) button more than 3 times to get into the safe removal mode.
If you want to play files in the safe removal mode, disconnect and reconnect the external USB storage device.
- ◆ USB hub will not be recognized.
- ◆ Directory names are shown up to 14 letters, and MP3 file names up to 30 letters.

Delay

- ◆ When selecting USB function, depending of the speed of the external USB storage device, reading (READ-IN) internal information can take several minutes.
- ◆ When playing a USB device, or finding next track may introduce some delay. Especially with a mass storage device such as HDD, depending on the type and the number of files, the delay might be several minutes.
- ◆ Even with the external USB storage devices of same capacity, depending on the speed of each product, the amount of operating time can vary.

Selecting a Track from USB Device

You can select a desired directory and an MP3 file during the play or when it stopped.

- Before you begin!** ◆ Connect the external USB storage device to your player.
◆ Select USB function by using the USB/AUX button.

- Press the **TUNING/ALBUM** ^ / v buttons to move the directory.
◆ Each time you press the button, it will move to the directory before or after and play.
◆ This function works only in the remote control.

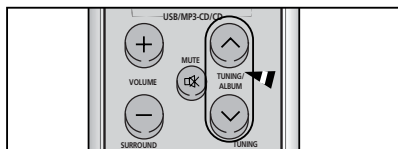

- If you want to move the file, press the ◀▶ button shortly.
◆ It moves the file within the directory.
◆ If you press the ◀▶ button more times than the number of the files in the directory, it will move over to the next directory.



To skip next 10 tracks

- Before you begin!** ◆ Connect the external USB storage device to your player.
◆ Select USB function by using the USB/AUX button.

- Press the **+10** button on the remote control shortly during the play.
◆ A track that is 10 tracks after the current track plays.

Example: If you want to select 43rd track while 15th track is playing, press the +10 button 3 times and then press the ▶▶ button 3 times.

15 → 20 → 30 → 40 → 41 → 42 → 43

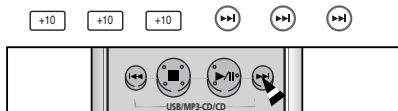

To use high speed search

- Before you begin!** ◆ Connect the external USB storage device to your player.
◆ Select USB function by using the USB/AUX button.

You can search the part you want quickly during the play

- Press and hold the ◀▶ button.
◆ Whenever you press and hold the button, you can search backward or forward 2X → SRCH OFF times quickly.



- ⚠ When you use the high speed search function, there is no sound.

To repeat

- Before you begin!** ◆ Connect the external USB storage device to your player.
◆ Select USB function by using the USB/AUX button.

- Press the **REPEAT** button during the play.
◆ REPEAT 1 : repeat play one track only.
◆ ALL 1: repeat play one directory only.
◆ REPEAT ALL : repeat play the entire directories.

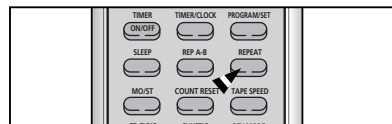

To repeat section

- Before you begin!** ◆ Connect the external USB storage device to your player.
◆ Select USB function by using the USB/AUX button.

- 1 Press the **REPA-A+B** button at the beginning of desired part.
◆ START shows.
- 2 Press the **REPA-A+B** button at the ending of desired part.
◆ END shows and section repeat is played 3 times.
Then it plays normal.

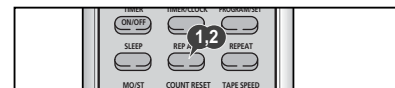

- ⚠ Section repeat function works only within one track.

To use Last Memory function

- Before you begin!** ◆ Connect the external USB storage device to your player.
◆ Select USB function by using the USB/AUX button.

Last Memory is a function that resumes playback from the last part of the previous listening when the user reselects USB function again after stopping the play, selecting another function(except CD function).

- Press the **PROGRAM/SET** button,
◆ LAST ON and LAST OFF are repeatedly selected.

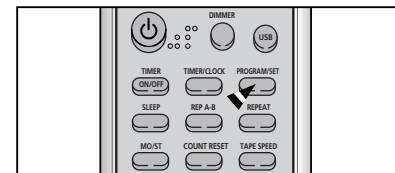

Listening to a Cassette

GB

- 1 Switch the system on by pressing **Standby/On** (⏻ / ⏻).
- 2 Select the **TAPE** function by pressing **TAPE** on the front panel.
- 3 Open the cassette deck by pushing on the corner of the cover marked **PUSH EJECT** until you hear a click and then release it.
- 4 Insert the pre-recorded cassette with the open edge of the tape facing downwards.
- 5 Close the deck by pushing on it until it clicks into place.
- 6 Press the **TAPE** (◀▶) button.
Side ATAPE (▶) once
Side BTAPE (▶) twice
Result: The cassette starts playing.

- 7 Press **TAPE SPEED** to adjust the speed of the tape playing. And each time the button is pressed, the mode changes as follows.

-10% SPEED → +10% SPEED → NORMAL

- 8 When the cassette is stopped, select one of the following functions as required.

To... Press...

Rewind the cassette..... ⏮ / ⏪

Fast-forward the cassette..... ⏭ / ⏩

> The cassette player stops

automatically when the beginning or end of the cassette is reached.

- 9 To stop the playback or search, press **Stop** (■) button.

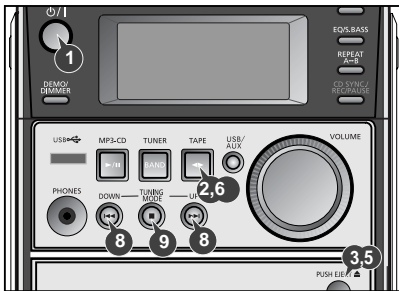

Recording a Compact Disc

Direct recording

The **direct recording mode enables you to start recording with any track on the compact disc.**

♦ You do not need to adjust the volume, as it has no effect on the recording.

- 1 Switch your system on by pressing **Standby/On** (⏻ / ⏻).
- 2 Insert a blank cassette in Deck.
- 3 Load a compact disc.
- 4 Press the **MP3-CD** (▶/||) button.
♦ Use the **CD selection** (◀◀, ▶▶) buttons to select the desired song.
- 5 Press the **REC/PAUSE** button.
Result: Recording will begin.
- 6 To stop recording, press **STOP** (■) button.

You can record a compact disc on a cassette in two different ways:

- ♦ Synchronised recording
- ♦ Direct recording

Synchronised recording

This feature enables you to synchronize the start of the recording with the start of the disc or track of your choice.

- 1 Switch the system on by pressing (⏻ / ⏻).
- 2 Insert a blank cassette in Deck.
♦ Press the **PUSH/EJECT** button (▲) to open the cassette door, insert a cassette, and then close the cassette door.
♦ Insert the cassette with the safety tabs.
- 3 Load a compact disc.
♦ Press the **PUSH/EJECT** button (▲) to open the CD door.
♦ Insert a CD and press the **PUSH/EJECT** button (▲) to close the CD door.
- 4 Press the **MP3-CD** (▶/||) button.
♦ Use the **CD selection** (◀◀, ▶▶) buttons to select the desired song.
Press and hold **CD SYNC/REC/PAUSE** button.
- 5 When stopped, press the button to start the recording from the first piece of music.
♦ Press and hold **CD SYNC/REC/PAUSE** button during the playback of CD to start the recording from the first part of the music being played.
- 6 To stop recording, press ■ button.

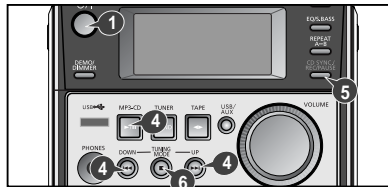

Recording a Radio Program

You can record a radio program of your choice.

♦ You do not need to adjust the volume, as it has no effect on the recording.

- 1 Switch the system on by pressing **Standby/On** (⏻ / ⏻).
- 2 Insert a blank cassette in Deck.
- 3 Select the **TUNER** function by pressing **TUNER/BAND**.
- 4 Select the radio station that you wish to record by pressing ⏮ or ⏭ button on the front panel or ∨ / ^ on the remote control.
- 5 Press **REC/PAUSE**.
Result: REC is displayed and recording starts.
- 6 To stop recording, press **STOP** (■) button.

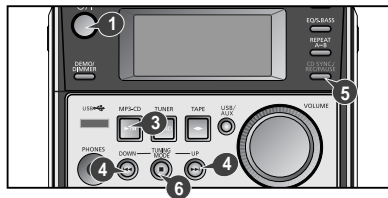

Timer Function

The timer enables you to switch the system on or off at specific times.

Example: You wish to wake up to music every morning.

- If you no longer want the system to be switched on or off automatically, you must cancel the timer.
- Before setting the timer, check that the current time is correct.
- ♦ For each step, you have a few seconds to set the required options. If you exceed this time, you must start again.

- 1 Switch the system on by pressing **Standby/On** (⏻ / ⏻).
- 2 Press **TIMER/CLOCK** until ⌚ **TIMER** is displayed.
- 3 Press **PROGRAM/SET**.
Result: **ON TIME** is displayed for a few seconds, followed by any switch-on time already set; you can set the timer switch-on time.

- 4 Set the timer switch-on time.
 - a Set the hour by pressing ∨ and ^.
 - b Press **PROGRAM/SET**.

Result: The minutes flash.
c Set the minutes by pressing ∨ and ^.
d Press **PROGRAM/SET**.

Result: **OFF TIME** is displayed for a few seconds, followed by any switch-off time already set; you can now set the timer switch-off time.

- 5 Set the timer switch-off time.
 - a Set the hour by pressing ∨ and ^.
 - b Press **PROGRAM/SET**.
 - c Set the minutes by pressing ∨ and ^.
 - d Press **PROGRAM/SET**.

Result: **VOL 10** is displayed, where 10 corresponds to the volume already set.

- 6 Press ∨ and ^ to adjust the volume level and press **PROGRAM/SET**.

Result: The source to be selected is displayed.

- 7 Press ∨ and ^ to select the source to be played when the system switches on.

If you select... You must also...

TAPE (cassette) Insert a recorded cassette in the deck.
TUNER (radio) Select the FM or AM (MW) frequency band by pressing ∨ and ^.
• Press **PROGRAM/SET**.
• Select a preset station by pressing ∨ and ^.

CD (compact disc) Load a compact disc.

USB Insert a USB.

- 8 Press **PROGRAM/SET** to confirm the timer.

- 9 Press **Standby/On** to set the system to standby mode.
Result: ⌚ is displayed on the top right of the time, indicating that the timer has been set. The system will switch on and off automatically at the required times.

➤ If the timer switch on and off times are identical, the word **ERROR** is displayed.

➤ You can use ⏮ / ⏭ button on the front panel instead of ∨ / ^ button on the remote control in step 4,5,6,7.

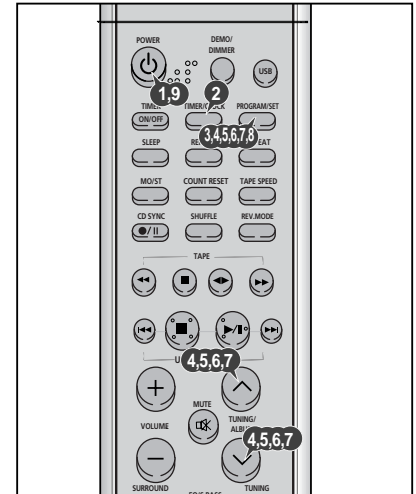

Cancelling the Timer

After having set the timer, it will start automatically as shown by the timer indication on the display. If you no longer wish to use the timer, you must cancel it.

➤ You can stop the timer at any time (system on or in standby mode).

To... Press **TIMER ON/OFF**...

Cancel the timer..... Once.
Result: ⌚ is no longer displayed.

Restart the timer..... Twice.
Result: ⌚ is displayed again.



Surround Mode function

GB

Your compact system is equipped with the function of Power Sound/Power Surround/Power Surround XT.

The Power Surround replaces conventional stereo sound with a wider and more true-to-life sound. It creates the feeling of being right at the centre of the music and being surrounded by total music sound.

The function of Power Sound amplifies bass and improves high key or bass twice as much for you to appreciate powerful real sound.

- Press **SURROUND MODE** button until the required option is selected. Each time the **SURROUND MODE** button is pressed, "PSOUND, PSURRD, PSUR XT, OFF" is selected or cancelled in this order.

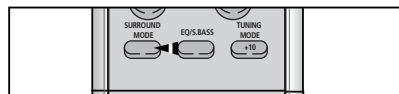

EQ/S.BASS (Super Bass) Function

Your Micro Component system has a bass amplification function and equipped with a preset equaliser that allows you to choose the most appropriate balance between treble and bass frequencies, according to the type of music you are listening to. That is called EQ/S.BASS.

This function makes the sound more powerful and real.

Press **EQ/S. BASS** on the front panel or **EQ/S. BASS** on the remote control until the required option is selected.

To obtain a...	Select...
Normal balance (linear).....	PASS
Balance suitable for pop music.....	POP
Balance suitable for rock music.....	ROCK
Balance suitable for classic music.....	CLASSIC
Balance suitable for jazz music.....	JAZZ
Balance suitable for s-bass music.....	S-BASS



Selecting the Cassette Playback Mode

Your micro component system has three cassette playback modes which enable you to listen to both sides of a cassette automatically.

Press **REV.Mode** until the appropriate symbol is displayed.

When the display indicates... The micro component system plays back...

- One side of the selected cassette and then stops.
- One side of the cassette. The other side of the cassette and then stops.
- Both sides of the cassette indefinitely until you press stop.



Shuffle Play Function

You can listen to the tracks on a compact disc in a different order each time, as the various tracks will be selected automatically in a random sequence.

- Press the **SHUFFLE** button.
 - ◆ If this button is pressed when the CD(SHUFFLE) or MP3-CD(RANDOM) is being played back or stopped, any track recorded in the CD may be selected to playback again..

- When playing tracks in a random order, you can:
 - ◆ Move on to the next track (selected at random) by pressing **SKIP**
 - ◆ Search quickly for a specific point in the current track by pressing and holding down **SKIP** more than one second.

- When you have finished the random playback, press **STOP** or press the **SHUFFLE** button again.

➤ Repeat and CD Synchro function are not available in Shuffle playing mode.

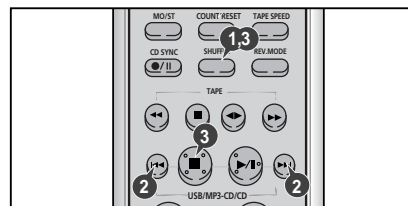

Sleep Timer

You can set the system to switch off automatically.

Example: You wish to fall a sleep to music.

- Press **SLEEP** on the remote control.

Result: The following indications are displayed:

90 MIN^{SLEEP}
- Press **SLEEP** one or more times to indicate how long the system should continue playing before it switches off:

90 MIN → 60 MIN → 45 MIN
 OFF ← 15 MIN ← 30 MIN

 - At any time, you can:
 - ◆ Check the remaining time by pressing **SLEEP**
 - ◆ Change the remaining time by repeating Steps 1 and 2
- To cancel the sleep timer function, press **SLEEP** one or more times until **OFF** is displayed and the word **SLEEP** disappears.



MUTE Function

You can turn the sound off temporarily.

Example: You wish to answer a telephone call.

- Press **MUTE**.
- To switch the sound back on (at the same volume as before), press **MUTE** again, or turn **VOLUME** button.



Connecting Headphones

You can connect a set of headphones to your micro component system so that you can listen to music or radio programs without disturbing other people in the room. The headphones must have a 3.5 mm connector or appropriate adaptor.

Connect the headphones to the Phones connector on the rear panel (or top right corner).

Result: The loudspeakers are no longer used for sound output.

➤ Prolonged use of headphones at a high volume may damage your hearing.

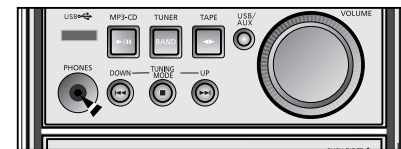

Microphone Function (option)

The microphone enables the user to mix in his or her vocals to sing-along with the music.

Preparation

Plug the microphone with a 3.5mm jack into microphone terminal.

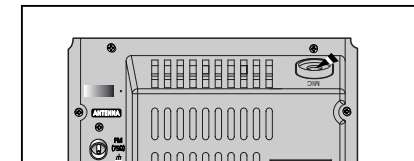

Tape Counter

When playing a cassette, a counter is displayed to enable you to take note of the counter value at the start of each track and thus start playback at the beginning of the track to which you wish to listen.

➤ The counter is only displayed when a cassette is being played.

Before starting to record a cassette for which you wish to take note of the counter values at the beginning of each track, reset the counter by pressing and holding **COUNTER RESET**.

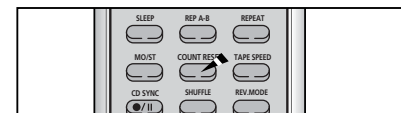

Safety Precautions

GB

The following diagrams illustrate the precautions to be taken when using or moving your micro-component system.

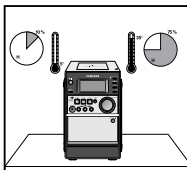

Ambient operating conditions:
Ambient temperature 5°C-35°C
Humidity 10-75%

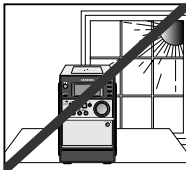

Do not expose the unit to direct sun radiation or other heat sources. This could lead to overheating and malfunction of the unit.

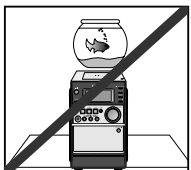

Do not place potted plants or vases on top of the unit. Moisture entering the unit could lead to dangerous electric shock and can cause equipment damage. In such events immediately disconnect the main plug from the socket.

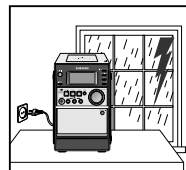

During thunderstorms, disconnect the main plug from the socket. Main voltage peaks due to lightning could damage the unit.

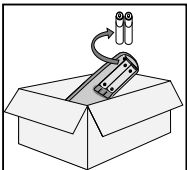

Remove the batteries from the remote control, if not used for any extended period. Leaking batteries can cause serious damage to the remote control.

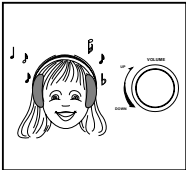

When using headphones, take care not to listen at excessive volumes. Extended use of headphones at high volumes will lead to hearing damage.

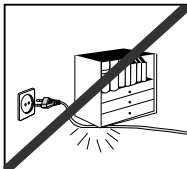

Do not place heavy items on the main lead. Main cable damage can lead to damage of the equipment (fire hazard) and can cause electric shock.

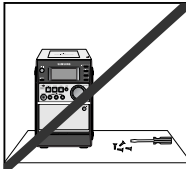

Do not remove any equipment panels. The inside of the unit contains live components, which cause electric shock.

Cleaning Your Micro-Component System

To obtain the best possible results from your micro-component system, you must clean the following elements regularly:

- ◆ The outer casing
- ◆ The compact disc player
- ◆ The cassette players (heads, rollers and drive capstans)
- ◆ Always unplug the system from the wall outlet:
 - ◆ Before cleaning it
 - ◆ If you are not going to be using it for a long time

Outer Casing

Clean the outer casing regularly using a soft cloth and a light detergent. Do not use abrasive powders, liquids or aerosol cleaners. Never let any liquids get into the system.

Compact Disc Player

- 1 Before playing a compact disc, clean it with a special CD cleaning agent. Do not use the same cleaning agents as for vinyl LP records. Carefully wipe the disc from the centre outward.
- 2 Regularly clean the player with a special cleaning disc (available from your local dealer).

Tape Decks

- 1 Press PUSH EJECT (▲) to open the cassette deck.
- 2 Use a cotton bud and a special cassette cleaning agent to clean the:
 - ◆ Head (1)
 - ◆ Rollers (2)
 - ◆ Drive capstans (3)

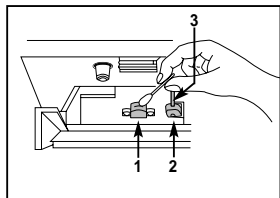

- ◆ If you will not be using the remote control for a long time, remove the batteries to prevent corrosion.
- ◆ Although your system is very hard-wearing, it should not be used in an excessively dusty environment or subjected to shocks or extreme heat (close to heating appliances or in direct sunlight, etc.).
- ◆ If the unit emits an unpleasant odour when in use, unplug it from the main supply and contact the after-sales service.

Precautions When Using Compact Discs

- ◆ Handle your compact discs with care. Always hold them by the edges to avoid leaving fingerprints on the shiny surface.
- ◆ When you have finished playing a compact disc, always put it back in its case.
- ◆ Do not fix paper or adhesive tape to the discs and do not write on the label.
- ◆ Clean them with a special-purpose cloth.
- ◆ Store your compact discs in a clean place, out of direct sunlight, where they will not be exposed to high temperatures.
- ◆ Always use compact discs marked **UDF**.

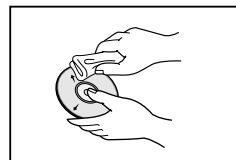

Precautions When Using Audio Cassettes

- ◆ Check that the tape in the cassette is sufficiently taut.
- ◆ To prevent erasing a cassette that you wish to keep, remove the safety tab on the upper edge of the cassette. To record a cassette, where the tab has been broken, simply cover the opening with adhesive tape.
- ◆ When you have finished playing a cassette, always put it back in its case.
- ◆ Store your cassettes in a clean place, out of direct sunlight, where they will not be exposed to high temperatures.
- ◆ Avoid using 120-minute cassettes as they place unnecessary strain on the tape mechanism.

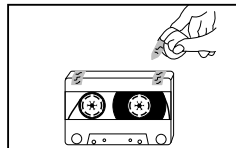
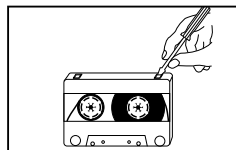
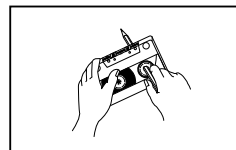

Before Contacting the After-Sales Service

GB

It always takes a little time to become familiar with a new appliance. If you have any of the problems listed below, try the solutions given. They may save you the time and inconvenience of an unnecessary service call.

Problem	Checks/Explanation
The system does not work	<ul style="list-style-type: none"> ◆ The main lead is not correctly plugged into a wall socket or the wall socket is not switched on. ◆ The remote control batteries need replacing or the polarity has not been respected. ◆ The STANDBY/ON button has not been pressed.
There is no sound	<ul style="list-style-type: none"> ◆ The volume has been completely turned down. ◆ The correct function (TUNER, MP3-CD, TAPE, AUX, USB) has not been selected. ◆ You have connected a set of earphones. ◆ The loudspeaker wires have been disconnected. ◆ The MUTE button has been pressed.
The Timer does not work	<ul style="list-style-type: none"> ◆ The timer has been stopped by pressing TIMER OFF.
In case it does not work, even the action is taken as above.	<ul style="list-style-type: none"> ◆ Press the STOP button for 5 seconds in power 'OFF' (standby), then it is returned the original position (RESET)
The compact disc player does not start playing	<ul style="list-style-type: none"> ◆ The CD function has not been selected. ◆ The disc has been inserted face down or is either dirty or scratched. ◆ The laser sensor is dirty or dusty. ◆ The system has not been installed on a flat, horizontal surface. ◆ Condensation has formed in the player; leave the system in a warm, airy room for at least one hour.
The MP-3 CD player cannot be played.	<ul style="list-style-type: none"> ◆ Use the PC to confirm if the extension is *.mp3.
The tape does not start playing	<ul style="list-style-type: none"> ◆ The TAPE function has not been selected. ◆ The cassette has not been inserted correctly. ◆ The cassette player has not been closed. ◆ The tape is either slack or broken.
The volume falls off	<ul style="list-style-type: none"> ◆ The audio heads are dirty.
The cassette is not erased correctly	<ul style="list-style-type: none"> ◆ The rollers or drive capstans are dirty.
There is excessive wow and flutter	<ul style="list-style-type: none"> ◆ The tape is worn.
Reception is poor or no radio stations are received at all	<ul style="list-style-type: none"> ◆ The TUNER function has not been selected. ◆ The radio frequency has not been correctly selected. ◆ The aerial has been disconnected or is not facing the right way. Turn it until you find the best orientation. ◆ You are in a building that blocks radio waves; you must use an outside aerial.

If the above guidelines do not allow you to solve the problem, take a note of:

- ◆ The model and serial numbers, normally printed on the rear of the system
 - ◆ Your warranty details
 - ◆ A clear description of the problem
- Then contact your local dealer or SAMSUNG after-sales service.

Technical Specifications

GB

SAMSUNG strives to improve its products at all times. Both the design specifications and these user instructions are thus subject to change without notice.

RADIO

AM (MW)

Signal/noise ratio	35 dB
Usable sensitivity	54 dB
Total harmonic distortion	2 %

FM

Signal/noise ratio	55 dB
Usable sensitivity	15 dB
Total harmonic distortion	1 %

COMPACT DISC PLAYER

Frequency range	20 Hz - 20 KHz
Signal/noise ratio	70 dB (at 1 KHz) with filter
Distortion	0.1 % (at 1 KHz)
Channel separation	45 dB
Disc sizes	Diameter: 120 or 80 mm. Thickness: 1.2 mm

TAPE DECK

Frequency range	125 Hz ~ 8 KHz
Signal/noise ratio	40 dB
Channel separation	30 dB
Erasing effect	45 dB

AMPLIFIER

Output power (6 Ω)	2 X 20 Watts RMS (total harmonic distortion : 10%)
Channel separation	40 dB
Signal/noise ratio	70 dB

GENERAL

Dimensions	145(W) x 226 (H) x 282(D) mm
------------	------------------------------

THIS APPLIANCE IS MANUFACTURED BY:



ELECTRONICS