

FCC Information

EN

This device complies with Part 15 of the FCC Rules. Operation is subject to the following two conditions: (1) This device may not cause harmful interference, and (2) this device must accept any interference received, including interference that may cause undesired operation.

This equipment has been tested and found to comply with the limits for a Class B digital device, pursuant to Part 15 of the FCC Rules. These limits are designed to provide reasonable protection against harmful interference in a residential installation. This equipment generates, uses and can radiates radio frequency energy and, if not installed and used in accordance with the instructions, may cause harmful interference to radio communications.

However, there is no guarantee that interference will not occur in a particular installation. If this equipment does cause harmful interference to radio or television reception, which can be determined by turning the equipment off and on, the user is encouraged to try to correct the interference by one or more of the following measures:

- Reorient or relocate the receiving antenna.
- Increase the separation between the equipment and receiver.
- Connect the equipment into an outlet on a circuit different from that to which the receiver is connected.
- Consult the dealer or an experienced radio/TV technician for help.

WARNING: Changes or modifications to this unit not expressly approved by the party responsible for compliance could void the user's authority to operate the equipment.

Ventilation

You must adequately ventilate the product. Make sure there is adequate space around the unit to provide proper air flow for ventilation. See diagram.

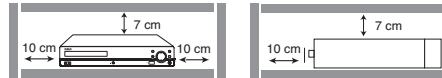

This product complies with DHHS Rules 21 CFR Subchapter J. Applicable at the date of manufacture.



This Home Theater has earned the ENERGY STAR.

Important Information

For your safety

The AC power plug is polarized (one blade is wider than the other) and only fits into AC power outlets one way. If the plug won't go into the outlet completely, turn the plug over and try to insert it the other way.

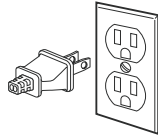

If it still won't fit, contact a qualified electrician to change the outlet, or use a different one. Do not attempt to bypass this safety feature.

Removing the power plug is the only way to completely remove power from your product. Make sure the power plug remains easily accessible.

Note:

This DVD player is designed and manufactured to respond to the Region Management Information. If the Region number of a DVD disc does not correspond to the Region number of this DVD player, this player cannot play the disc. The Region number for this DVD player is Region 1.



CAUTION: TO REDUCE THE RISK OF ELECTRIC SHOCK, DO NOT REMOVE COVER (OR BACK). NO USER-SERVICEABLE PARTS INSIDE. REFER SERVICING TO QUALIFIED SERVICE PERSONNEL.

WARNING: TO PREVENT FIRE OR ELECTRICAL SHOCK HAZARD, DO NOT EXPOSE THIS PRODUCT TO RAIN OR MOISTURE.

CAUTION: USE OF CONTROLS OR ADJUSTMENTS OR PERFORMANCE OF PROCEDURES OTHER THAN THOSE SPECIFIED MAY RESULT IN HAZARDOUS RADIATION EXPOSURE.

CAUTION: DANGER OF EXPLOSION IF BATTERY IS INCORRECTLY REPLACED. REPLACE ONLY WITH THE SAME OR EQUIVALENT TYPE.

WARNING: MAINS PLUG IS USED AS DISCONNECT DEVICE AND IT SHOULD REMAIN READILY OPERABLE DURING INTENDED USE. IN ORDER TO DISCONNECT THE MAINS PLUG FROM MAINS COMPLETELY, THE MAINS PLUG SHOULD BE DISCONNECTED FROM THE MAINS SOCKET OUTLET COMPLETELY.

THE LIGHTNING FLASH AND ARROWHEAD WITHIN THE TRIANGLE IS A WARNING SIGN ALERTING YOU OF "DANGEROUS VOLTAGE" INSIDE THE PRODUCT.

THE EXCLAMATION POINT WITHIN THE TRIANGLE IS A WARNING SIGN ALERTING YOU OF IMPORTANT INSTRUCTIONS ACCOMPANYING THE PRODUCT.

Service information

This product should be serviced only by those specially trained in appropriate servicing techniques. For instructions on how to obtain service, refer to the warranty included in this Guide.
RFC: CTM-9800723-KS5

Main plug is used as the disconnect device, it shall remain operable and should not be obstructed during intended use. To be completely disconnected the apparatus from supply mains, the main plug of the apparatus shall be disconnected from the mains socket outlet completely.

Caution

Invisible laser radiation when open. Avoid exposure to beam. Class 1 laser product. This system must be opened only by qualified technicians to prevent accidents caused by the laser beam.

DVD copy protection

In accordance with the DVD standard, your DVD player is equipped with a Copy Protection system, which can be switched on and off by the DVD disc itself, in order to make any recording of the relevant DVD disc onto a videotape of very poor picture quality, or even impossible. This product incorporates copyright protection technology that is protected by method claims of certain U.S. patents and other intellectual property rights owned by Macrovision Corporation and other rights owners. Use of this copyright protection technology must be authorized by Macrovision Corporation, and is intended for home use only unless otherwise authorized by Macrovision Corporation. Reverse engineering or disassembly is prohibited.

Important Information

EN

Important battery information

- Do not mix different types of batteries or new and old batteries. Do not use rechargeable batteries.
- In order to avoid any risk of explosion, observe the polarities indicated inside the battery compartment. Replace only with the type of batteries specified. Do not dispose of them in a fire or recharge them.
- If you are not using the remote control for a long period of time, remove the batteries.

Please respect the environment and prevailing regulations. Before you dispose of batteries or accumulators, ask your dealer whether they are subject to special recycling and if they will accept them for disposal.



Illustrations contained in this document are for representation only.

Battery shall not be exposed to excessive heat such as sunshine, fire or the like.

CAUTION

- This product utilizes a laser. Use of controls or adjustments or performance of procedures other than those specified herein may result in hazardous radiation exposure. Do not open covers and do not repair yourself. Refer servicing to qualified personnel.
- To reduce the risk of fire or electric shock, do not expose this product to rain or moisture. No objects filled with liquids, such as vases, should be placed on the apparatus.

This Class B digital apparatus complies with Canadian ICES-003.

Cet appareil numérique de la class B est conforme à la norme du NMB-003 du Canada

WARNING

To reduce the risk of fire or electric shock, do not expose this product to rain or moisture. No objects filled with liquids, such as vases, should be placed on the apparatus.

CLASS I LASER PRODUCT
LASER KLASSE I
LASERAPPARAT AV KLASSE I
AREIL A LASER DE CLASSE I
LUOKAN I LASERLAITE
LASERPRODUKT AF KLASSE I

Important Safety Instructions

Please read and save for future reference

Some of the following information may not apply to your particular product; however, as with any electronic product, precautions should be observed during handling and use.

- Read these instructions.
- Keep these instructions.
- Heed all warnings.
- Follow all instructions.
- Do not use this apparatus near water.
- Clean only with dry cloth.
- Do not block any ventilation openings. Install in accordance with the manufacturer's instructions.
- Do not install near any heat sources such as radiators, heat registers, stoves, or other apparatus (including amplifiers) that produce heat.
- Do not defeat the safety purpose of the polarized or grounding-type plug. A polarized plug has two blades with one wider than the other. A grounding type plug has two blades and a third grounding prong. The wide blade or the third prong is provided for your safety. If the provided plug does not fit into your outlet, consult an electrician for replacement of the obsolete outlet.
- Protect the power cord from being walked on or pinched particularly at plugs, convenience receptacles, and the point where they exit from the apparatus.
- Only use attachments/accessories specified by the manufacturer.
- Use only with the cart, stand, tripod, bracket, or table specified by the manufacturer, or sold with the apparatus. When a cart is used, use caution when moving the cart/apparatus combination to avoid injury from tip-over.



Portable Cart Warning

- Unplug this apparatus during lightning storms or when unused for long periods of time.
- Refer all servicing to qualified service personnel. Servicing is required when the apparatus has been damaged in any way, such as power-supply cord or plug is damaged, liquid has been spilled or objects have fallen into the apparatus, the apparatus has been exposed to rain or moisture, does not operate normally, or has been dropped.

Additional safety information

- Apparatus shall not be exposed to dripping or splashing and no objects filled with liquids, such as vases, shall be placed on the apparatus.
- Always leave sufficient space around the product for ventilation. Do not place product in or on a bed, rug, in a bookcase or cabinet that may prevent air flow through vent openings.
- Do not place lighted candles, cigarettes, cigars, etc. on the product.
- Connect power cord only to AC power source as marked on the product.
- Care should be taken so that objects do not fall into the product.
- Do not attempt to disassemble the cabinet. This product does not contain customer serviceable components.

If your product operates on batteries, adhere to the following precautions:

- A. Any battery may leak electrolyte if mixed with a different battery type, if inserted incorrectly, or if all batteries are not replaced at the same time.
- B. Any battery may leak electrolyte or explode if disposed of in fire or an attempt is made to charge a battery not intended to be recharged.
- C. Discard leaky batteries immediately. Leaking batteries can cause skin burns or other personal injury. When discarding batteries, be sure to dispose of them in the proper manner, according to your state/provincial and local regulations.

Table of Contents

EN

Connections and Setup	1
Connecting to your TV (VIDEO).....	2
Connecting to your TV (via HDMI input)	
Connecting AUDIO from external sources such as a TV (Aux-in)	4
Connecting the speakers.....	4
Positioning speakers	5
Front speaker placement	
Better surround placement	6
Test tone/Channel balance	
Overview of Controls	7
Front panel controls	
Remote control	
Remote control functions in TUNER mode	8
Using the remote to Navigate through On Screen Menus.....	9
Playing Discs – Basic Functions	9
Compatible discs/formats	
Regional coding	
Operating the DVD receiver	
Basic Playback Operations	10
Types of Menus	
The Info Menu	11
Using the Info menu	
Title/chapter (DVD)/track (audio CD)	
Time Display	12
Audio (DVD)/Subtitles (DVD)/ Camera Angle (DVD)	13
Play mode	
Creating a Program list for Play Mode	
Bookmark/Sleep/Introscan(CD)	14
Mp3/WMA Files and jpeg Files	15
Playing mp3/WMA Files or displaying jpeg files	
Radio	16
Manual Tuning	
Storing radio stations	
USB Device	17
Connecting/Disconnecting USB devices to the Main Unit	
USB Device Playback Features	
Aux-In	17
Connecting auxiliary components	
Selecting the auxiliary mode	
Sound output in the auxiliary mode	
CD Ripping	18
An overview	
Ripping CD to USB device	
Start Ripping CD	
File Names of Ripped Files	
Deleting Files	
The Setup Menu	19
General Setup	
Password	
Rating	20
Slide Time	
Default	
Language Setup.....	20
Player Menu	
Audio	
Subtitles	
Disc Menu	21
Audio Setup	21
Night Mode	
Distance	
Test Tone	22
Video Setup	22
Video	
TV Type	
HDMI Setup	
Brightness	
Additional Information	23
Troubleshooting	
Precautions	24
Compatible Formats	25
Sound Enhancement Systems.....	26
Technical Specifications.....	27
Limited Warranty	28

Connections and Setup

EN

Accessories provided



Remote control and
2 AAA batteries

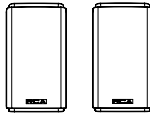

Left and right
front speakers

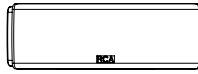

Center speaker

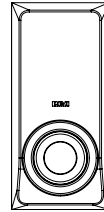

Subwoofer

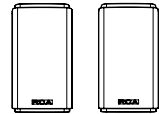

Left and right
Surround
Speakers



One external AM
loop antenna

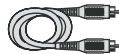

Composite
Video Cable



One Pig-Tail
antenna wire

Things to consider before you connect

- Ensure that the mains supply in your house complies with that indicated on the identification sticker located on the back of your unit.
- Install your unit horizontally, away from any source of heat (fireplace) or appliances creating strong magnetic or electric fields. The components of this unit are sensitive to heat. The maximum ambient temperature should not exceed 35°C/95°F.
- Leave enough space around the unit to allow adequate ventilation: 10 cm/4 inches on either side and above the top, and 5 cm/2 inches at the rear.
- The humidity of the room should not exceed 75%. If you have to use the unit outdoors, do not expose it to rain or splashing water. The apparatus should not be exposed to dripping or splashing and no objects filled with liquids, such as vases, should be placed on the apparatus.
- Moving the unit from a cold place to a warm one can cause condensation on some components inside the unit. Let the condensation disappear on its own before turning the unit on again.
- Before moving the unit, make sure the disc tray is empty.
- Where the mains plug or an appliance coupler is used as a disconnect device, the disconnect device shall remain readily operable.
- Other important use and cleaning information at the end of the booklet.

Connections and Setup

EN

Connecting the antennas

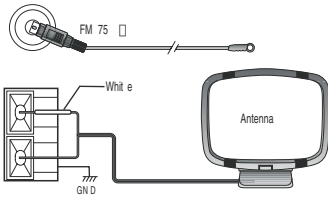

The AM and FM antennas connect to the AM and FM terminals on the system's back panel. They must be hooked up in order to receive clear reception.

AM Loop Antenna

1. Uncoil the AM Antenna wire.
2. Press down on the Antennas tab to open the terminal.
3. Make sure the white wire on the AM loop antenna is inserted into the AM loop terminal and the other wire is inserted into the ground loop terminal.

Connecting to your TV (VIDEO)

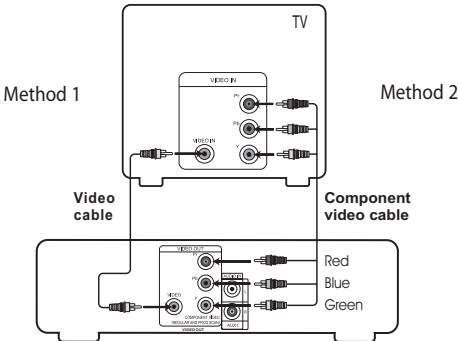

Method 1

Composite video jack (yellow)

- The basic video jack is color-coded yellow.
- Video cable (yellow) is supplied for the connection for good picture quality.
- Connect the video OUT jack on the receiver to the IN jack on your TV so the video content goes from the receiver to the screen.

Method 2

Component video jacks (Pr, Pb, Y)

- The component video jacks are color-coded green, blue and red.
- Additional component video cables (not supplied) are required to provide best picture quality. They are usually color-coded green, blue and red.
- Connect the component video OUT jacks on the receiver to the component video IN jacks on your TV so the video content goes from the receiver to the screen.

- If your television is a high definition television, use the unit's progressive scan output to get the highest possible video resolution. Set the Progressive Scan option in the Video menu to On (See page 22).
- If one of the devices is not working, check that all the cables have been inserted properly into the jacks.
- If your component has only one input for audio (mono), connect it to the left (white L/Mono) audio jack on the TV and don't connect the right audio part of the cable.



Connecting to your TV (via HDMI input)

HDMI stands for High Definition Multimedia Interface. HDMI transfers digital audio and uncompressed digital video on a single cable. Press the HDMI button on the remote control to change output signals as follows: 480p, 720p, 1080i and 1080p.

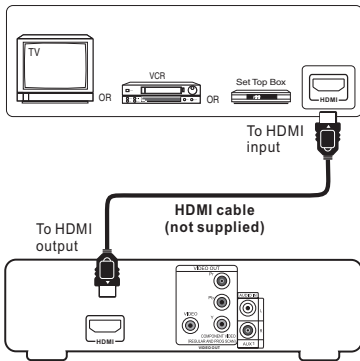

Notes:

- Refer to the owner's manual of the connected TV as well.
- When using HDMI, do not connect to other analog video outputs.

Connecting AUDIO from external sources such as TV (Aux-In)

Using AUDIO IN (AUX 1) jacks

Connect the AUDIO IN (AUX 1) jacks from the unit to the AUDIO OUT jacks on VCR, TV, Set Top Box or other component.

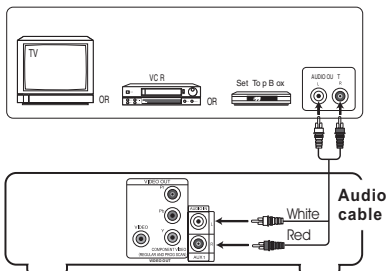

Using AUX IN 2 jacks

Connect the AUX IN 2 jacks on the front panel of the unit to the AUX OUT (AUDIO OUT) jacks on VCR, TV, Set Top Box or other component.

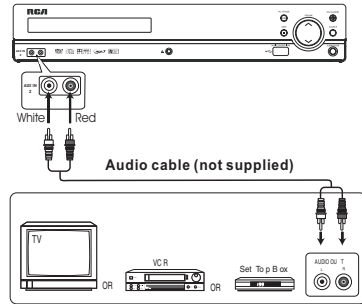

Notes:

- Audio cables (color-coded in red and white) (not included) are required.
- Press either SOURCE on the main unit or AUX1/2 on the remote control to select AUX1 IN or AUX2 IN mode.
- To listen to the audio input from the connected component, press SOURCE on the main unit or AUX on the remote control to select the AUX mode. Refer to page 17 for details.

Connecting the speakers

Speaker wires are color-coded to match the terminals. Connect the speaker wire from the back of each speaker to the corresponding color terminal at the back of the unit. Press down the tab to open the terminal and insert the wire. Release the tab to lock wire in the terminal.

EN

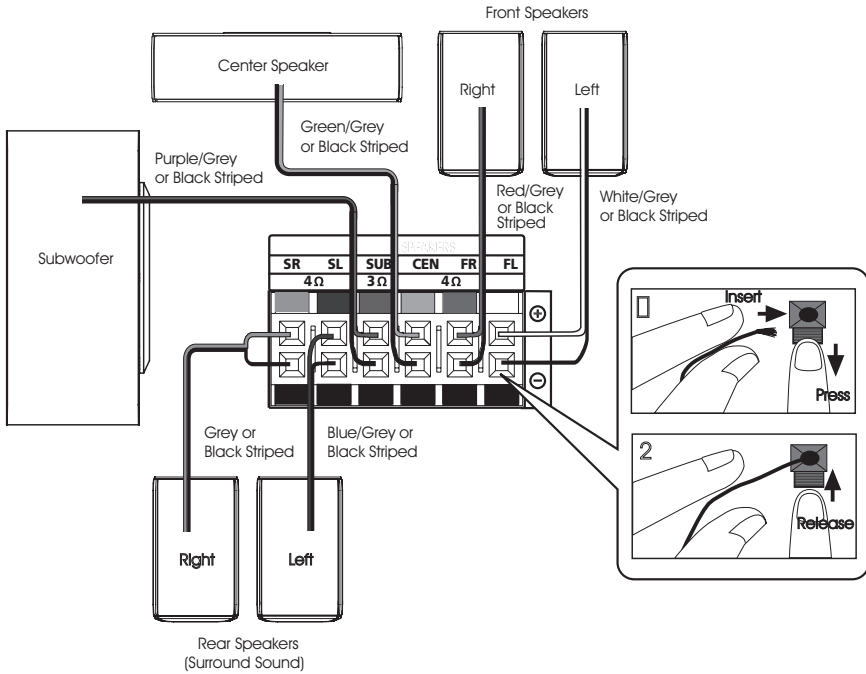

Note: When connecting the speakers, make sure the polarities ("+" speaker wire to "+" on the receiver. For example, red wire to red terminal on the receiver) of speaker wires and terminals match. If the cords are reversed, the sound will be distorted. Do not let the speaker wires touch each other, it will damage the speaker.

Connections and Setup

Positioning speakers

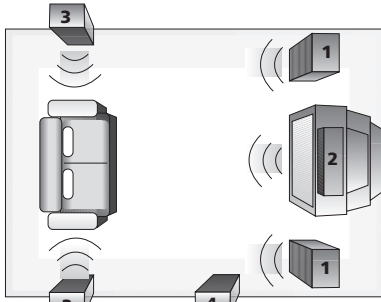

Courtesy Dolby Laboratories

1. Left, Right (Front Speakers)

Front speakers carry primarily music and sound effects.

2. Center

In surround mode, the center speaker carries most of the dialog as well as music and effects.

It should be set between the left and right speakers.

3. Surround (Rear Speakers)

The surround speakers' overall sound balance should be as close as possible to the front speakers. Proper placement is vital to establish an evenly distributed sound field.

4. Subwoofer

A subwoofer is designed to reproduce powerful low bass effects (explosions, the rumble of spaceships, etc.).



Note: Front, Center speakers provided with this unit are magnetically shielded to protect your TV set. It is not recommended to place the surround speakers and subwoofer near the TV set.

Front speaker placement

For best results, follow the speaker placement below.

Alignment

Align the center speaker evenly with (A) or slightly behind (B) (the left and right speakers), but not ahead of them.

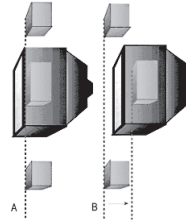

Angle

Place the left and right speakers to form a 45-degree angle with your favorite viewing position to duplicate the soundtrack mixer's perspective.

Height

The three front speakers should be as close as possible to the same height. This often requires placing the center speaker directly on top (A) or beneath (B) the TV set.

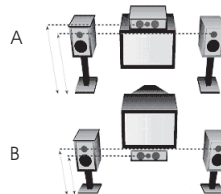

Better surround placement

Location

If possible, place surround speakers to either side of the listening area, not behind it.

EN

Height

If space permits, install surround speakers 2-3 feet above viewers. This helps to minimize localization effects.

Aiming

Aim surround speakers straight across the room, not down at viewers, to help create a more open, spacious surround sound field.

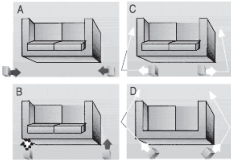

Alternative Surround Placement

Rear wall

If rear wall mounting is the only choice, aim the speakers at each other (A), towards the front (B) or towards the sidewalls (C, D). Experiment with placement until sounds seem to surround you, rather than come from behind you.

No adjacent walls

Surround speakers can go on stands facing each other to approximate sidewall mounting (A), or to the sides or rear of the viewing area, aimed upwards; they can go right on the floor, or preferably, a few feet off the floor such as on end tables (B).

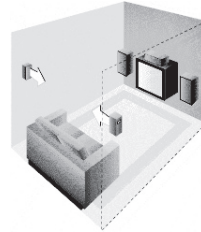

Test tone/Channel balance

Channel balance

Your receiver is equipped with a test signal generator for balancing the channels. As the signal "travels" from channel to channel, adjust the level controls until each channel plays at the same loudness level (see page 20).

Level adjustment and surround channel level expectation

Even though you adjust the surround channel to be as loud as the others on the test signal, on actual program material the surround channel is adjust the surround level; program producers use surround for subtle atmospheric and ambience, and only rarely for special effects.

Overview of Controls

Front panel controls

EN

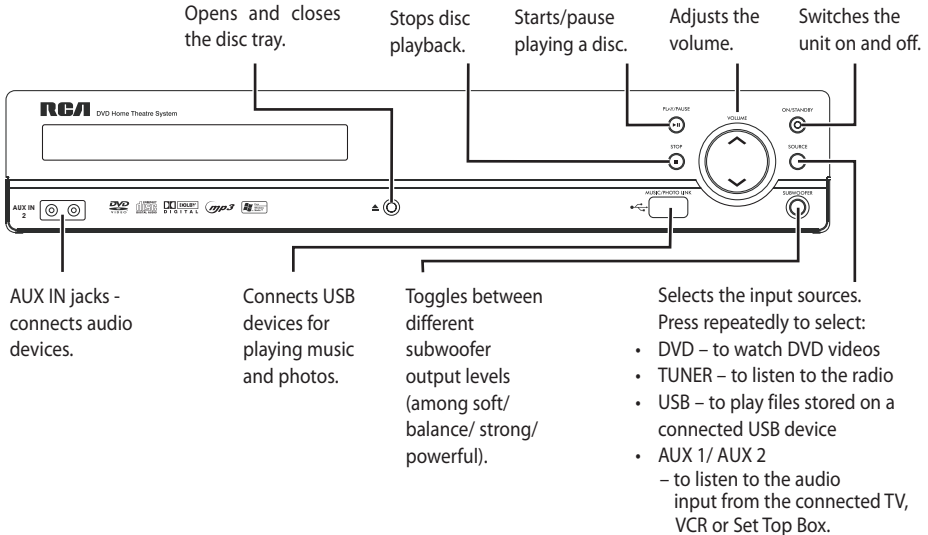

Remote control functions in DVD/CD mode

ON-OFF – Switches the unit on and off (p.9).

DVD – Selects the DVD mode (p.9).

TUNER – Selects the TUNER and selects between FM/AM (p.16).

USB – Selects the USB mode (p.17).

AUX 1/2
– Selects the Auxiliary input (for listening to audio input from connected TV, VCR or Set Top Box) (p.18).

0-9 – Number entry.

CLEAR – Quits the current setting manually from the TV screen without saving change.

INFO – Accesses the Info menu (p.11).

TITLE – Accesses the title menu of DVD discs (p.14).

DISC MENU – Accesses the disc menu during playback.

OK – Confirms your selection.

△ ▽ < > – To navigate through the menus (read page 8 for details). The left and right arrows also tune the radio frequency in the tuner mode.

MUTE – Mutes and restores the sound.

SETUP – Enters Setup menu (p.19).

RETURN – In DVD mode, returns to the previous menu.

VOL +/- – Adjusts the sound volume.

CH +/ ►►, CH -/ ◄◄ – Directly accesses the next or previous chapter (DVD) or track (CD) (p.9). Selects programmed stations in TUNER mode (p.15).

REV – Starts reverse accelerated play or reverse slow motion (p.10).

PLAY – Starts playing a disc (p.10).

FWD – Starts forward accelerated play or forward slow motion (p.10).

REC – Accesses or quits the CD Ripping menu (p.18).

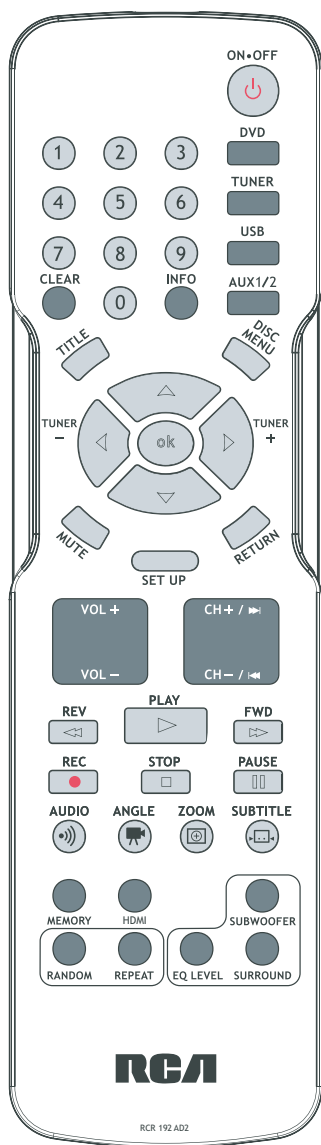

STOP – Stops playback. Press and hold to open the disc tray (p. 9, 10).

PAUSE – Freezes frame, accesses frame advance or slow motion function (p.10).

AUDIO – Accesses the audio function (p.12).

ANGLE – Accesses the camera angle function for DVD disc (p.13).

ZOOM – Accesses the Zoom function (p.10, 15).

SUBTITLE – Selects the subtitle languages or turns subtitle off (if available) (p.12).

HDMI – Changes video output signals (480p, 720p, 1080i or 1080p) (p.14).

SUBWOOFER – Selects among subwoofer output levels (soft/balance/strong/powerful).

RANDOM – Turns on/off random playback on CDDA/mp3/wma/jpeg discs.

REPEAT – Accesses the repeat function.

EQ. LEVEL – Toggles channels for different channel level settings. Adjusts the value using VOL +/-.

SURROUND – Changes the Surround sound setting. In DVD mode, press the button to select between Dolby Digital and Stereo modes (Dolby ProLogic is available if the input is Dolby 2 ch). In the Aux-In mode (analog input), press the button to select between Dolby ProLogic and Stereo modes. (Refer to page 27 for details on Dolby Digital and Dolby ProLogic.)

Remote control functions in tuner mode

TUNER – Selects the TUNER and switch between FM/AM (p.16).

VOL+/- – Adjusts the sound volume.

MUTE – Mutes and Restores the sound.

TUNER +/- – Tunes down and up the radio frequencies (p.16).

MEMORY – Stores a station (p.16).

CH+/- – Selects programmed stations (p.16).

AUDIO – Selects between Stereo and Mono mode for Tuner (FM) (p.16).

Overview of Controls

Using remote control to navigate through the on-screen menus

Use \wedge \vee \langle \rangle and OK on the remote control to navigate through the on-screen displays (the DVD player's menu, the Info Display that appears during playback, or a disc's menu).

Use \wedge \vee \langle \rangle on the remote to move through on-screen menus in the direction of the arrow button (e.g., to move right, press \rangle). The arrow buttons are used to highlight an option. Once highlighted, press OK to select the option that is highlighted.

Note:

Insert 2 "AAA" ("UM-4"/"R03") batteries to the remote control prior to use.



EN

Playing Discs - Basic Functions

Compatible discs

- DVD, DVD-R, DVD-RW, DVD+R, DVD+RW
- CD, CD-R, CD-RW

Compatible formats

- DVD, JPEG
- CD, mp3, WMA

See page 24 and 25 for more information about discs and compatible formats.

Regional coding

Your unit has been designed to process regional management information stored on DVD discs. The regional code for your unit is 1. Discs that have a different regional code will not play.

Operating the DVD receiver

1. Turn on your television set.
2. Press ON-OFF on the remote or ON/STANDBY located on the unit's front panel. Press DVD on the remote control.

Loading disc

1. Press \blacktriangle on the front panel or press and hold STOP on the remote control to open the disc tray.
2. Insert a compatible disc into the disc slot.
3. Press \blacktriangle again to close the disc tray.

Basic playback operations

Playback

Switch the unit and the TV set on.

1. After loading a disc, playback starts automatically, or the disc menu appears. If the disc menu appears, select the Play option to begin playback.
2. Press STOP to stop playback.

Accelerated play

While the disc is playing, press REVERSE or FORWARD one or more times to vary the speed and direction of the accelerated play. Press PLAY to resume normal playback.

Pause

While the disc is playing, press PAUSE once for freeze frame. Press PLAY to resume normal playback.

Frame advance

1. Press PAUSE twice. FRAME is displayed.
2. Press FWD to move forward one frame at a time.
3. Press PLAY to resume normal playback.

Variable slow motion

1. While the disc is playing, press PAUSE once. PAUSE is displayed.
2. Press REV or FWD a number of times to vary the speed.
3. Press PLAY to resume normal playback.

Changing chapter/track

While the disc is playing, press the CH+/- button to go immediately to the next or previous chapter, or to the next or previous track.

Zoom

1. While a disc is playing, press ZOOM until you reach the zoom size you want. The ZOOM button toggles through 2x, 3x, 4x and then zooms out to 1/2x, 1/3x and 1/4x, then returns to normal playback.
2. Move from one area to another (pan) using the arrow buttons.
3. To turn ZOOM off, press ZOOM until you get to the ZOOM OFF option.

Types of menu

- Disc menu — The appearance and contents of this menu varies according to the type of disc you have inserted. It is separate from the Setup menu.
- Info menu — The unit's Info menu appears at the top of the screen while the disc is playing. Press INFO on the remote to switch the Info menu on or off.



- Setup menu — Press SETUP to access this menu.

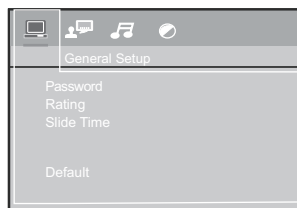

Playing Discs - Basic Functions



Notes:

- When you press STOP, the unit stores the point where playback was interrupted. If you press PLAY again, playback resumes from this point. To stop playback completely or to start again from the beginning, press STOP twice. If the unit is left in STOP mode for more than five

minutes without any user interaction, a screen saver is activated. At the end of 30 minutes without any user interaction, the unit switches off automatically.

EN

The Info Menu

Using the Info menu

1. Press INFO on the remote while a disc is playing to display the Info menu. The first banner shows title, chapter, and time display information.
2. Press INFO again for audio language, subtitles, and camera angle.
3. Press INFO a third time for play mode, bookmark and sleep timer.
4. Use the right/left arrow buttons on the remote to select an icon.
5. Use the up/down buttons to scroll through the options.



Note:

INVALID KEY will be displayed if the function you select is not available.

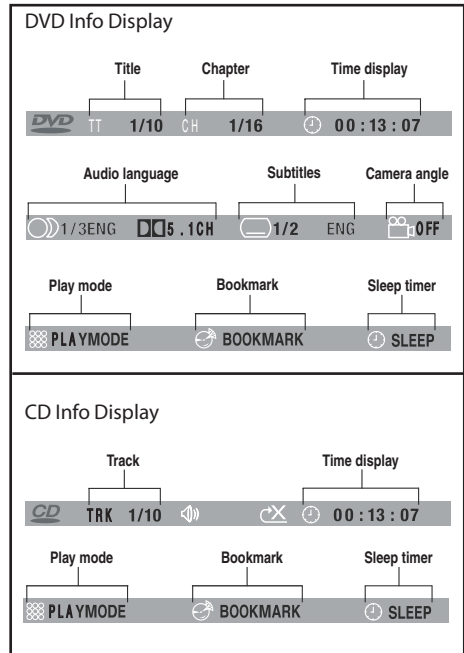

Title/chapter (DVD)/track (audio CD)

To directly access a title, chapter (DVD) or a track (audio CD), press INFO, press OK. Select the Title(TT), Track(TRK) or Chapter(CH) icon and enter a number directly with the numeric buttons. Press OK again to confirm.



Note: Many discs only have one title.

Time display

To access the Time Display, press INFO on the remote. Press the up/down buttons repeatedly to display:
DVD: Chapter elapsed time, Chapter remaining time, Title elapsed time and Title remaining time.

Audio CD: Track elapsed time, track remaining time, disc elapsed time, disc remaining time.

To directly access a location on the disc which does not correspond to the start of a title or chapter, press INFO once and press OK, highlight the Time Display icon using the arrow buttons, then enter a time with the number buttons (hh:mm:ss) and press OK.



Note: Time display function may not be available on all discs.

Audio (DVD)

Some discs have several audio tracks used for different languages or different audio formats.

To change the language or audio format during playback:

1. Press the INFO button twice.
2. Use the left/right arrow buttons to select the Audio icon, or press the AUDIO button on the remote control.
3. Choose a language or an audio format with the up/down arrow buttons.

This option is only available if the disc offers dialog languages or audio formats. When you change the dialog language using the Info menu, it only changes the dialog language of the disc being played. When you eject the disc or switch off the unit, the language will revert to the one you selected in the Language Setup menu (see page 21).

Subtitles (DVD)

Subtitles are turned off by default. Turn on Subtitles as follows:

1. While the disc is playing, press INFO twice, then select the Subtitles icon using the left/right arrow buttons.
2. Select a language using the up/down arrow buttons.
3. To turn subtitles off, select the Off option or press SUBTITLE on the remote.

When you change the language of the subtitles using the Info menu, it only applies to the disc currently being played. When you eject the disc and switch off the unit, the subtitles will default to the subtitle language you selected in the Languages menu (see page 21). This function may not be available on all discs.

The Info Menu

Camera angle (DVD)

Some discs offer different camera angles for specific scenes.

1. To change the camera angle, press the ANGLE button on the remote or press the INFO button twice and select the Camera angle icon with the left/right buttons.
2. Choose the angle with the up/down arrow buttons.

If the disc was recorded using a single camera angle, this function is not available.

Play mode (all discs except mp3/WMA/jpeg)

1. While the disc is playing, press the INFO button twice for CD and three times for DVD.
2. Select the Play Mode icon using the left/right arrow buttons.
3. Use the up/down arrow buttons to select an option.
 - DVD play modes: standard, program, A-B repeat, title repeat, chapter repeat. Program play mode is only available if a program list has been created (see below). Repeat mode is only available with discs that display elapsed time and remaining time. To repeat a sequence between points A and B, choose the A-B repeat option, and then follow the instructions for entering the two points.
 - Audio CD play modes: standard, introscan, random, program, repeat A-B, repeat disc, repeat track.
4. To stop repeat playback, select the Play Mode icon and use the up/down arrow buttons to choose the Standard option.



Note:

- For mp3 play modes, please refer to page 15.

Creating a Program List for Program Play Mode (Audio CDs and DVD discs)

To use program play mode, you must first create a program list.

1. To create a program list, press the INFO button three times. Highlight the Play Mode option and press the up arrow to select the Program option.
2. Press OK. The Program screen is displayed.
3. The first spot in the list is highlighted. Use the number buttons on the remote to enter a track number. As for DVD discs: T stands for Title while C stands for Chapter. As for Audio CDs: T stands for Track.
4. Use the arrow buttons to move to the next spot in the list. Enter the next track number.
5. Continue entering tracks until you have completed your list.
6. Highlight the Play option at the bottom of the screen and press OK or press PLAY to start playback. The program list will play in the order you programmed it.

To stop program play, press STOP or select Standard from the Play Mode option in the INFO display.

If you want to cancel the list, repeat steps 1 and 2 to select CLEAR and press OK.

Creating a program List for program play mode (mp3 CDs)

To use program play mode with an mp3 disc, you must first create a program list. You can program up to 16 songs.

1. To create a program list, press the INFO button twice. Highlight the Play Mode option and press the down arrow to select the Program option.
2. Press OK. The Program screen is displayed.
3. The F stands for Folder, and the T stands for Track. Highlight the space below the Folder indicator (F) and use the number buttons to enter the desired folder number.
4. Use the arrow buttons to move to the space beneath the Track indicator (T). Use the number buttons to enter the track number.
5. Repeat steps 3 and 4 until you have completed your list.
6. Highlight the Play option at the bottom of the screen and press OK or press PLAY to start playback. The program list will play in the order you programmed it.

To stop program play, press STOP or select Standard from the Play Mode option in the INFO display.

If you want to cancel the list, repeat steps 1 and 2 to select CLEAR and press OK.

Bookmark (DVD and audio CD)

1. Press INFO twice for CD and three times for DVD. Select the Bookmark icon with the left/right buttons, and press OK. A menu is displayed with five bookmarks.
2. The first bookmark space is highlighted. Press OK to set the bookmark. The bookmark is saved and is indicated by the number 1. You can set up to five bookmarks on a disc.
3. To start playback from a bookmark, press the PLAY button on the remote.
4. To delete a bookmark, highlight it and press CLEAR.



Note: This function is only available with discs whose elapsed time or remaining time appears in the Info menu.

Sleep

1. Press INFO twice for CD and three times for DVD. Select Sleep icon with the left/right arrow buttons.
2. Select one of the available options using the OK button or pressing the SLEEP button on the remote: Off, 30, 60, 90 or 120 minutes.



Note: This function is not available in AUX/TUNER mode.

Introscan (CD)

This option plays the first ten seconds of each track on a CD.

1. Press the INFO button twice, then select the Playmode icon with the left/right arrow buttons.
2. Press the up/down arrow buttons to select the INTRO option and press OK to start IntroScan.
3. Press STOP to stop Introskan, and press PLAY to resume normal playback.

Playing mp3/WMA files or displaying jpeg files

Mp3/WMA is an audio file format which compresses recorded music. The main advantage of the mp3/WMA format is that CD-quality music tracks can be stored on a personal computer in user friendly compressed files.

Jpeg files are image files. Make sure that they have a resolution of less than 2 megapixels.

1. Open the disc tray.
 2. Place the disc with the printed side facing up and close the disc tray.
The folders on the disc will be listed in numerical order on the left side of the screen. When you highlight a folder, the list of songs or pictures in the folder are listed in numerical order on the right side of the screen.
 3. Select a folder using the up/down arrow buttons on the remote, then press the left arrow button to move to the music/picture icons at the bottom of the screen. Use the left/right arrow buttons to select either music or picture mode.
 4. Press the up arrow button to move to the file list on the right side of the screen. Use the up/down arrow buttons to select a file. Press OK or PLAY to start playback.
- mp3/WMA file: the unit begins playing the selected file, then all the files and subfolders contained in the same folder. The unit then plays the contents of the folders at the same level as the folder containing the file selected at the start.
 - jpeg file: the unit starts the slide show with the jpeg file you have selected, then displays all the jpeg files in the same folder, then all the jpeg files in the subfolders located in the same folder. You can set the amount of time a picture remains on the screen in the General Setup menu (see page 19).

During the slide show you can use the left/right button to rotate the picture, the

up arrow button to rotate the image vertically, the down arrow button to rotate the image horizontally. Use the ZOOM button to magnify the picture. Use the CH- button to go back to the previous picture or the CH+ button to go to the next one, and the STOP button to interrupt the slide show and display the disc's contents.

5. Press INFO to display the Info menu during playback. mp3/WMA file: with the disc playing, press INFO two times and select the Play Mode icon using the left/right arrow buttons. Press the up/down arrow button to select a play mode (Standard, Random, Program, Repeat Folder, Repeat Disc and Repeat Track), and press OK.
6. When the unit has played all the files, the music or slide show stops and the disc's contents are displayed again.
7. Press STOP to end playback.



Notes:

- mp3/WMA files and jpeg files could not playback simultaneously.
- The time taken for the contents of the disc to be displayed varies according to the size and number of jpeg files on the disc. If nothing is displayed after a few minutes, the file sizes may be too large. Reduce the files' resolution and write another disc.
- Before inserting a disc, make sure it is compatible with the unit.

The unit has a built-in tuner that allows for FM radio function. The AM loop antenna allows for AM radio function.

Manual tuning

1. Connect the FM antenna and the AM loop antenna at the back of the unit. Rotate the AM loop for better reception.
2. Press TUNER.
3. Tune a station by pressing TUNER+/- repeatedly until the desired station is found. Alternatively, you can press and hold the same buttons down for about one second to activate the automatic search function. In this mode the unit will automatically tune frequencies until it finds a station.
4. Repeat step 3 to tune to another radio station.
5. Press TUNER to toggle between FM and AM.

Storing radio stations

The unit can store up to 30 radio stations in its memory. You can enter every single radio station yourself or the unit can store all available radio stations automatically in ascending order.

Automatic preset programming

1. Press TUNER to enter the Tuner mode.
2. Press and hold TUNER for two seconds to start automatic preset programming.
3. Radio frequencies will be browsed and radio stations stored automatically. When all the available radio stations are stored or all 30 memory locations are full, the auto preset programming function will stop.

Manual preset

1. Tune to a radio station (see "Manual tuning" for details).
2. Press MEMORY. While the Program Preset number is still flashing, input your desired preset number using the numeric buttons or press the CH+/- buttons, then press MEMORY to store it.

Retrieving preset stations

1. Press TUNER to enter the Tuner mode.
2. Press CH +/- to search up or down for the preset stations or directly press the numeric buttons.



Tips:

- When the FM station broadcasts Stereo sound is found, ST is displayed.
- When you manually tune into a weak FM station, press AUDIO on remote control to switch from Stereo to Mono mode. This will reduce the background noise.
- If there is any interference, change the antenna's position until ideal sound reception is obtained. TV and other electronic devices could be the cause of interference, so try to position the antenna away from them.
- A weak signal can affect the "Automatic preset programming" function's efficiency. Adjust the antenna for better reception and a more efficient search.

USB Device

An overview

This unit supports MSC devices. You can connect your own USB storage devices, then you can start playback.

Connecting/Disconnecting USB device to the Unit

Insert the USB drive's connector into the main unit's USB jack of the unit. To disconnect, unplug the drive.

USB device playback features

1. Press USB to select USB mode.
2. Playback starts automatically. Press PAUSE to pause playback and press PLAY again to resume.
3. Press STOP to end playback.
4. Press CH+/- buttons on the remote control to skip to the previous or next file.
5. You may also follow the playback instruction steps 3-7 on playing mp3/WMA files and jpeg files on P.14.



Note: The unit only support mp3/WMA/jpeg files on USB device.

EN

Aux-In

TV, VCR or Set Top Box can be connected to AUX input jacks at the back of the unit so that sound from the auxiliary component comes into the unit and out through the speakers.

Connecting auxiliary components

Refer to page 3 "Connecting to external audio sources (Aux-In)" for details on connecting the auxiliary components to the unit.

Selecting Aux-In mode

Press either SOURCE on the main unit or AUX1/2 on the remote control to select AUX1 IN or AUX2 IN mode.

Sound output in Aux-In mode

- You may change the surround setting by pressing SURROUND to select between Dolby ProLogic and Stereo modes.
- If the auxiliary audio signal is mono (e.g. TV audio), there is no output from surround speakers in either Dolby ProLogic or Stereo mode.
- Refer to page 26 for details on Dolby Digital and Dolby ProLogic.

CD Ripping

EN

An overview

CD ripping allows you to rip tracks on CD to USB device. This unit supports Mass Storage Class (MSC) devices. Connect the USB device first before ripping.

Ripping CD to USB device

1. During CD playback, press REC on the remote to activate the Ripping Menu.
2. Select one of the menu items using the up/down arrow buttons. Press the left/right arrow buttons or OK to change the setting.

Speed

High speed ripping mode can save time when ripping from CDs. Select 1x(normal speed) or 2x(double speed) by pressing the left/right arrow buttons. Press the down arrow button to move to the next menu item.

Source

You can select to rip one track(TRACK), the whole disc(ALL TRACKS) or programed tracks (PROGRAM). Press the down arrow button to move to the next menu item.

Destination

The destination of the ripped files is defaulted as USB. No selection is needed.

Start Ripping CD

Highlight START and press OK to start ripping.

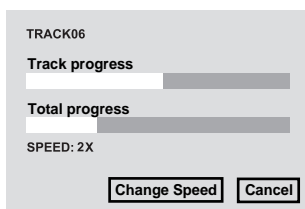

The screen above appears when ripping start. The first progress bar represents the progress percentage of the current ripping track while the second progress bar represents the total percentage. The percentage of both bars will be identical if there is only one track to rip.

To stop ripping during the process, highlight "Cancel" button and press OK.

When ripping has finished, press REC to quit the ripping menu.

File Names of Ripped Files

You can find the ripped files saved in a folder named "CDRECORD" with file name as "CDTKxx01", "CDTKxx02"...etc.



Notes:

- The USB device for CD ripping must be connected to the unit in Mass Storage Class (MSC) mode. Your device should be shown as a drive letter, instead of the name of the USB device, when connected to the computer in MSC mode.
- CD Ripping function only supports CDDA discs.
- During 1x ripping, the audio output is for monitoring purpose only. It does not represent the true audio quality recorded.
- During 2x ripping, the audio output is muted.
- CD Ripping function does not support ripping files to Multi Card Reader via USB port.
- "NO USB DEVICE" will be displayed if no USB device is connected to the unit.
- "NO PROGRAM TRACK" will be displayed if no program list is created.
- "USB DEVICE IS FULL" will be displayed if the USB device is full.
- "USB WRITE PROTECT" will be displayed if the USB device is write-protected. You should switch off the write protection first.
- You can select ripping speed even after ripping is started. Highlight the SPEED option and press the left/right arrow buttons.
- "DEVICE REMAIN" indicates the total remaining time of the USB device.

The Setup Menu

There are four options in the main setup menu: General Setup, Display Setup, Speaker Setup and Language Setup.

Press **SETUP** to bring up the main menu. Select one of the menu icons across the top of the screen using the left/right arrow buttons. The menu's options are displayed on the left side of the screen. Press the right arrow button to move to the option's choices on the right. Highlight **EXIT SETUP** and press **OK** if you want to exit setup.

General Setup

You can control access to the unit and the type of discs your family can watch with the lock function. Locking the unit prevents playback of DVDs that may not be suitable for all audiences by using the rating level encoded on the disc (not all discs are rated). If the rating level of the disc is higher than the preset level, playback is prohibited unless a password is entered.

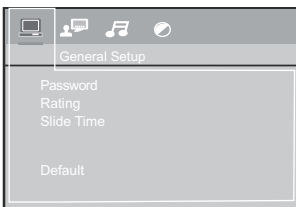

Password for Locking the Unit

1. To activate locking according to your preset rating limits, highlight the **PASSWORD** option using the up/down arrow buttons and select **LOCK** and press **OK**.
2. You are asked for a new password. Enter four digits using the number buttons and press **OK**.
3. You are asked for confirmation; enter the four digits again and press **OK**.

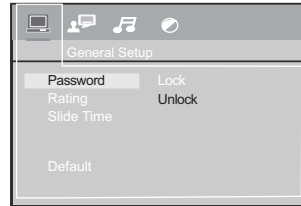

Password for Unlocking the Unit

1. To unlock the unit or set a new password, highlight the **PASSWORD** option using the up/down arrow buttons and select **UNLOCK**.
2. Enter your password and press **OK**.

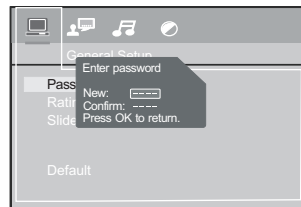

Changing the Password

When you unlock the unit, you must assign a new password the next time you lock the unit.

To change the current password, unlock the unit as described above, and then relock it.



Notes:

- Choose a password that is easy to remember, or write it down.
- Use the super password: 9688 if you have forgotten your password.

Rating Explanations

- The disc publisher is responsible for coding scenes according to the rating limits. Below is an explanation of Ratings.
- To change the rating limit, highlight the RATING option and press the right arrow button. Select the rating limit using the up/down arrow buttons and press OK.
- Rating limits take affect only when the unit is locked.

- 1 Kid safe – Kid safe; it is safe even for kids.
- 2 G – General Audience; recommended as acceptable for viewers of all ages.
- 3 PG – Parental Guidance suggested.
- 4 PG13 – Material is unsuitable for children under age 13.
- 5 PG-R – Parental Guidance-restricted; recommended that parents restrict children under age 17 from viewing or allow children to view only when supervised by a parent or adult guardian.
- 6 R – Restricted, under 17 requires accompanying parent or adult guardian.
- 7 NC-17 – NO children under age 17; not recommended viewing for children under age 17.
- 8 Adult – Mature material; should be viewed only by adults, due to graphic sexual material, violence, or language.

SlideTime

The Slide Time option lets you select the amount of time a picture is displayed in a slide show. The choices are 3 seconds, 5 seconds, or 10 seconds.

Default

This option allows you to return the unit's settings to the original factory settings. Any changes you have made to the unit's settings will be reverted back to the original settings, except the password.

Language Setup

With this menu, you can set the language for unit menus, dialog, subtitles and the disc menus.

If you chose "English" during initial set-up, any menus generated by the disc are in English, and so is the language of the dialogs (if this language is available on the disc).



1. Select the Language Setup icon in the main menu using the left/right arrow buttons.
2. Select one of the options using the up/down arrow buttons.
3. Press the right arrow button to move to the language choices.
4. Use the up/down arrow buttons to highlight the language of your choice and press OK.

Player Menu

Select the language of player menus and press OK.

Audio

Select the dialog language using up/down arrow buttons and press OK.

To change the Audio language during playback, press INFO twice for DVD and use the left/right arrow buttons to highlight the Audio icon.

Press the up/down arrow buttons or AUDIO on the remote control to select audio language.

Subtitles

Select the subtitle language using up/down arrow buttons and press OK.

To change the language of the subtitles during playback, press INFO twice for DVD and use the left/right arrow buttons to highlight the Subtitle icon. Press the up/down arrow buttons or the SUBTITLE button on the remote to select a subtitle language.

Disc Menu

To change the language of the disc menus, select the language using the up/down arrow buttons and press OK.

The language you select will only be displayed if the disc is programmed with that language.



Notes:

- If the selected language is not available on a disc, the disc's language will be used instead.
- If the language chosen is available, it is automatically selected when you display the subtitles or press SUBTITLE on the remote control. Otherwise, the subtitle language indicated on the disc is selected.

Audio Setup

You can adapt your unit to other equipment and access specific functions with the Audio Setup menu.

1. Select the Audio Setup icon in the main menu using the left/right arrow buttons.
2. Select an option using the up/down arrow buttons. Press the right arrow to move to the option's choices.

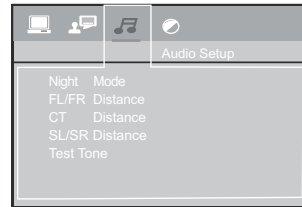

Night Mode

You can use this function to control the different sound levels via dynamic compression. It improves the quality of the sound track at a low volume, and quiets the loudest sounds. You can choose between Quiet, Moderate or Off.

Distance

Basic settings have been preset for the speakers included with your unit. However, to suit the acoustic conditions in your listening room and to make the sound more effective, you may need to delay the signal coming from some of the speakers. Channel delay compensates for center or surround speakers that are closer to the listening position than the front speakers.

1. Highlight a distance option using the up/down arrow buttons.
 - Front (FL/FR Distance)
 - Center (CT Distance)
 - Surround (SL/SR Distance)
2. Press the right arrow button to move to the default distance.
3. Press the up/down arrow buttons to adjust the distance.

Test Tone

This function is used to test the speaker setting and change the speaker level. A short noise comes successively from each speaker.

Notes:

- Night mode function is available only on DVD discs recorded in Dolby Digital.
- The receiver speaker distance default settings are as follows:

Front (FR/FL Dist.)	15 ft
Center (Cen Dist.)	15 ft
Surroudn (SR/SL Dist.)	10 ft

Video Setup

1. Select the Video icon in the main menu using the left/right arrow buttons.
2. Select a menu option using the up/down arrow buttons and press OK.

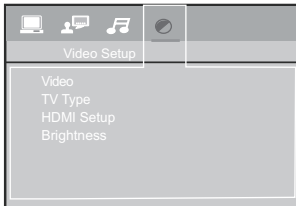

TV Type

Depending on the format of the DVD disc, you can choose the picture format (aspect ratio) best suited to the format of your TV screen:

- 4:3 PS: reproduces a 4:3 picture without distortion.
- 4:3 LB: gives best reproduction of pictures recorded in this format (i.e. with horizontal bands at the top and bottom of the screen) or in 16:9.
- 16:9 (widescreen): reproduces 16:9 format films in full on a 16x9 screen.

Video

Progressive Function provides high quality pictures with less flickering. Turn on Progressive Scan if you used the Component Video jacks of the unit to connect a TV or monitor compatible with a progressive scan signal.

Select P-Scan YPbPr and press OK to activate Progressive Scan.

HDMI Setup

This lets you select the resolution of the player's output according to the connected TV.

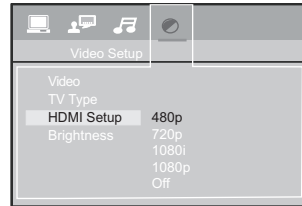

- Supported HD JPEG mode: 480p, 720p, 1080i and 1080p.

Brightness

This option lets you adjust the video brightness level on a scale of 0 to 12, with 12 being the brightest.

IMPORTANT!

Once Progressive Scan has been activated, an image will only be visible on a progressive scan TV or monitor. If you choose this option and you do not have a progressive scan TV or monitor, you may get a picture with incorrect color or no color.

Press and hold SUBWOOFER on the front panel. The video output will be restored to the standard setting and a picture will once again be visible on a conventional analog TV or monitor.

Troubleshooting

The unit does not switch on.

- Make sure it is plugged in.
- Press the ON-OFF button on the remote control or the ON/STANDBY button on the front of the unit.

The device switches off spontaneously.

- The device switches off automatically when it is in STOP mode for more than 30 minutes without any user intervention. Switch it on again.
- It might be impossible to read the disc.
- Insert the disc with the printed side facing up.
- Check that the disc can actually be played by this device (see page 25).
- Check that the disc's regional code matches the unit's regional code. This unit's regional code is 1.
- Clean the disc.

There is no picture.

- Check you have switched on the TV set.
- Check the connections (see pages 2, 21).
- Select the AV input assigned to the unit on the TV.

The picture is of poor quality (with snow or lines).

- Check the connections (see pages 2 and 21).

There is no sound or the sound is of poor quality.

- Check the connections (see page 2 and 4).
- Make sure the speakers are connected.
- Make sure the MUTE function is not on.

No surround sound.

- Check the speaker configuration in the Setup menu (See Positioning speaker on pages 4-5 or Audio Setup on page 19).

I can't find my file in the WMA/mp3/jpeg listing.

- Make sure the filename is valid (see page 25 and 26).

The remote control does not work or works only intermittently.

- Check that batteries are inserted or change them.
- Aim the remote control at the unit. The infrared beam must not be blocked or interrupted.
- Check that the remote control is configured to control the device you are trying to operate with it.

The subtitles do not appear.

- Check that the DVD disc provides subtitles.
- Refer to the section on how to display subtitles (see page 12).

The disc menu language is not the correct one.

- The disc menu language has not been set up (see page 22).
- The language of your choice is not available on the disc (see page 22).

You have forgotten your password (Parental control).

- Use the super password: 9688.

Precautions

Use

- If your unit has been stored in a cool place for any length of time, during a journey for example, wait for about 2 hours before using it.
- The openings located on the top and bottom are for ventilation and must not be obstructed.
- During thunderstorms, we recommend that you isolate the unit from the electrical supply so that it is not damaged by electrical or electromagnetic surges.
- This unit is designed for continuous use. Switching off the unit to standby mode does not disconnect it from the mains supply. To completely isolate the equipment, remove the plug from the mains jack as some components remain connected to the electrical supply.
- If you notice any burning or smoke, disconnect the unit immediately to avoid any risk of electrocution.
- Do not attempt to look inside the unit through the disk tray opening or any other opening. You may be electrocuted or exposed to laser radiation.
- This unit is for domestic use only and must not be used for industrial purposes.
- Total or partial copying of recordings protected by copyright legislation, without the explicit permission of the holder of the rights, contravenes current legislation. Copying or downloading music files for sale or any other business purpose constitutes or could constitute a violation of copyright law.

Cleaning

- Use a soft, dry, clean cloth. Regularly dust the vents at the back or sides.
- Using solvents, abrasive or alcohol-based products risks damaging the unit.
- If an object or liquid enters inside the unit, unplug it immediately and have it checked by an authorized servicer or service center.

Handling and caring for discs

- Handle your discs with care. Hold the disc with your fingers at the edges or through the hole.
- Insert the disc with the label facing up (for a single-sided disc).
- Place the disc properly into the tray in the allotted holder.
- Use a soft cloth to clean discs if necessary, always wiping from the centre to the edge.
- Always put discs back in their cases after use and store in a vertical position.
- Do not close the tray with two discs in it or with a disc not sitting correctly in the holder.
- Do not play cracked, chipped or warped discs nor try to repair them with adhesive tape or glue.
- Do not write on a disc.
- Do not move the unit when a disc is being played.
- Do not scratch discs or store them in places exposed to direct sunlight, high humidity or high temperatures.
- Do not use aerosol cleaners, benzene, anti-static liquids or any other solvent for cleaning discs. When cleaning, wipe gently with a soft damp (water only) cloth from the centre to the edge, avoiding circular motions, which could cause scratches and interference during playback.

Additional Information

Compatible Formats

In order to ensure playback, discs must conform with DVD or CD standards. This unit may not play some recordings or files due to differences in recording formats, software used and disc types.

DVD-Video

Digital video discs - 12 cm, single or double sided, single or dual layer. DVDs are high density optical discs on which high quality picture and audio are recorded by means of digital signals.



DVD-R, DVD-RW, DVD+R, DVD+RW

Most DVD-R and DVD+R (one recording only), DVD-RW and DVD+RW discs (rewritable), depending on the DVD writer and discs used. Recordings using DVD-R and DVD-RW discs must be made in Video DVD mode. Recordings using DVD+RW discs must be made in accordance with the specifications for DVD+RW discs with a 4.7 GB capacity.



Audio CDs

Audio CDs (12 cm).



CD-R, CD-RW

Most CD-R (one recording only) and CD-RW discs (rewritable).



CD-Rs written during a multisession recording can be played, provided that the session has ended before the disc is played (depending on the write software).

However, depending on the condition of the CD-writer, computer and the disc used, you may find that not all discs will play. When playing a CD-R disc, it is normal for the unit to take up to 20 seconds to recognize the disc before starting to play.

If the disc is not recognized after a period of 20 seconds, remove the disc, and insert it again.

- Do not use its full capacity.
- CD-Rs should be preferably used instead of CD-RWs (rewritable CDs) as, in certain cases, CD-RW playback may be faulty.
- Use reliable, good-quality CD write software.
- Close all other applications on the computer to ensure reliable CD-R disc recording.

Mp3 files

CD-R and CD-RW discs containing audio files in mp3 format. For CD-R mp3 discs, please follow all the recommendations for CD-R, along with the comments below:



- Your mp3 files should be ISO 9660 or JOLIET format. ISO 9660 format and Joliet mp3 files are compatible with Microsoft's DOS and Windows, as well as with Apple Mac.
- Mp3 filenames should not exceed 8 characters, and should end with the ".mp3" extension. General name format: Title.mp3. When composing your title, use 10 characters or less, no spaces, and avoid the use of special characters including (, , / , \, =, +).
- The total number of files on a disc should be less than 400.
- Use a decompression transfer rate of at least 128 kB/sec (kilobytes/second) when recording mp3 files. Sound quality with mp3 files basically depends on the rate of compression/ decompression you choose. Obtaining audio CD quality sound requires an analog/digital sampling rate, that is conversion to mp3 format, of at least 128 kB/sec and up to 160 kB/sec. Choosing higher rates, such as 192 kB/sec or more, only rarely produces even better sound quality. Conversely, files with sampling rates below 128 kB/sec will not play properly.

- Do not record copyright-protected mp3 files. "Securized" files are encrypted and code protected to prevent illegal copying.

jpeg files

CD-R and CD-RW with jpeg files. Certain jpeg files, including progressive jpeg files, cannot be read by this unit.



IMPORTANT!

The above recommendations do not guarantee that the unit will play mp3 recordings, or as an assurance of sound quality. Certain technologies and methods for mp3 file recording on CD-Rs prevent optimal playback of these files on your unit (i.e. degraded sound quality and in some cases, inability of the unit to read the file).

The total number of files and folders on the disc should be less than 650. Make sure that files have the ".jpg" extension. Files without the ".jpg" extension will not be able to be read by the unit — even though the files are shown as jpeg images on your computer.

WMA files

CD-R and CD-RW discs containing audio files in WMA (Windows Media Audio) format. Please follow all the recommendations for CD-R above.



Sound Enhancement Systems

This receiver is equipped with several built-in sound enhancement systems.



Manufactured under license from Dolby Laboratories. "Dolby", "Pro Logic", and the double-D symbol are trademarks of Dolby Laboratories.

Dolby Prologic

The Pro Logic mode uses the built-in circuit to steer the Left, Center, Right and Mono Surround channel audio signals and uses all five speakers to play both stereo and Dolby Pro Logic program source, such as TV and VCR.

You can use this mode with any stereo program source (such as VCR/TV) to enjoy multi-channel sound experience.

Dolby Digital

The Dolby Digital mode lets you enjoy full digital surround from software processed in the Dolby Digital format. Dolby Digital provides better sound quality and a more powerful presence than conventional Dolby Surround. This unit is equipped with Dolby Digital 5.1-channel so that you can enjoy enhanced full digital surround sound. Different from Dolby Pro Logic in that only four channels (Front Left, Front Right, Centre and Rear) are used, the new system provides stereo separation of the rear speakers (Rear-Right, Rear-Left). Adding the to the 5 channels the subwoofer channel for bass sounds (counted as 0.1 channel) results in 5.1 channels (or 6 Channels) that bring you the most sophisticated Dolby Digital sound enjoyment.

Additional Information

Technical Specifications:

Amplifier Section:

RMS Output Power: Dolby Digital Mode with 10% Total Harmonic Distortion

Rear Channels: 40Watts
channel (1KHz, 4Ohm)

Front and Center Channel: 40 Watts
per channel (1KHz, 4Ohm)

Subwoofer Channel: 50Watts
(100Hz, 3Ohm)

Total RMS Output Power, Dolby Digital
mode: 250Watts

FTC Output Power: Dolby Digital Mode with 10% Total Harmonic Distortion

Front Channels (L and R): 20 Watts per
Channel (1KHz, 4Ohm)

Rear Channels (L and R): 20 Watts per
Channel (1KHz, 4Ohm)

Center Channel: 30 Watts (1KHz, 4Ohm)

Subwoofer Channel: 35 Watts
(100Hz, 3Ohm)

Total FTC Output Power, Dolby Digital mode:
145 Watts

Muting Attenuation: 70 dB

Frequency Response: 200Hz – 20KHz/3dB,
1KHz ref.

Subwoofer Frequency Response:

20Hz – 200Hz/-3dB, 100Hz ref.

Signal to Noise Ratio: 70 dB

(Dolby digital mode)

AM Tuner Section:

Frequency Response: 2kHz +/-3dB, 400Hz ref.

Usable Sensitivity: 3000uV/m @ S/N 20dB

Signal to Noise: 38dB

IF Rejection: 35dB

FM Tuner Section:

Frequency Response: 15kHz +/-3dB, 1kHz ref.

Quieting: 24dB

Signal to Noise: 62dB(stereo) / 65dB(mono)

IF Rejection: 70dB

Dimensions (H x W x D mm) :

Unit: 66 x 360 x 294

Front Speakers: 214 x 78 x 68

Center Speaker: 78 x 291 x 68

Rear Speakers: 214 x 78 x 68

Subwoofer: 311 x 145 x 270

Limited warranty

AVC MULTIMEDIA ("AVC") makes the following limited warranty. This limited warranty extend to the original consumer purchaser and is limited to non-commercial use of the product.

One Year Parts & Labor Warranty

AVC products purchased in the United States are warranted to be free from defects in materials or workmanship for a period of one year from the date of their original retail purchase. If the unit fails to conform to this warranty, we will service the product using new or refurbished parts and products, at **AVC's** sole discretion.

During a period of one year from the effective warranty date, **AVC** will provide, when needed, service labor to repair a manufacturing defect at its designated Service Center. To obtain warranty service in the Untied States, you must first call our **Customer Support Center at 1-866-444-5746 or 1-800-252-6123, during the hours listed in the box below.** The determination of service will be made by **AVC** Customer Support. **PLEASE DO NOT RETURN YOUR UNIT TO AVC WITHOUT PRIOR AUTHORIZATION.** New or remanufactured replacements for defective parts or products will be used for repairs by **AVC** at its designated Service Center for one year from the effective warranty date. Such replacement parts or products are warranted for an additional one year from the date of repair or replacement. The Customer will be required to ship the unit to the Service Center indicated at the time Customer Support is contacted to make the necessary repairs. The customer is responsible for all transportation charges to the service facility.

Packaging and Shipping Instruction

When you send the product to the **AVC** service facility you must use the original carton box and packing material or an equivalent as designated by **AVC.**

LIMITED WARRANTY

Your Responsibility

- 1) You must retain the original sale receipt to provide proof of purchase.
- 2) These warranties are effective only if the product is purchased and operated in the U.S.A. or Canada.
- 3) Warranties extend only to defects in material or workmanship, and do not extend to any product or parts which have been lost or discarded, or damage to product or parts caused by misuse, accident, improper operation or maintenance, or use in violation of instructions provided with the product, or to product which has been altered or modified without authorization of **AVC,** or to products or parts thereof which have had the serial number removed or changed.

Out of Warranty

In the event your product requires repair after the limited warranty period has expired, please contact our Customer Support Center at **1-866-444-5746, 1-800-252-6123 or www.1800customersupport.com/RCA**
Hours: Monday–Thursday: 9am–7pm, Friday: 9am–5pm, Saturday: 9am–NOON Eastern time.

Important:

You are responsible for any transportation, shipping or insurance relative to the return of product to our Product Returns Center.

All warranties implied by state law, including the implied warranties of merchantability and fitness for a particular purpose, are expressly limited to the duration of the limited warranties set forth above. With the exception of any warranties implied by state law as hereby limited, the foregoing warranty is exclusive and in lieu of all other warranties, guarantees, agreements and similar obligations of manufacturer or seller with respect to the repair or replacement of any parts. In no event shall **AVC** be liable for consequential or incidental damages.

No person, agent, distributor, dealer or company is authorized to change, modify or extend the terms of these warranties in any manner whatsoever. The time within action must be commenced to enforce any obligation of **AVC** arising under the warranty or under any statute, or law of the United States or any state thereof, is hereby limited to one year from the date of purchase. This limitation does not apply to implied warranties arising under state law.

This warranty gives you specific legal rights and you may also have other rights, which may vary, from state to state. Some states do not allow limitation on how long an implied warranty lasts, when an action may be brought, or the exclusion or limitation of incidental or consequential damages, so the above provisions may not apply to you.

For more information on other products and services, please visit our web site at

www.1800customersupport.com/RCA

Important:

Also keep your "Bill of Sale" as proof of purchase.

Model no. Product name

Type of set

Serial no. Invoice no.

Date purchased Dealer name

FOR SERVICE AND REPAIR, PLEASE VISIT **www.1800customersupport.com/RCA**

Specifications and external appearance are subject to change without notice.



AVC Multimedia Inc.
Unit 6, 170 Esna Park Drive,
Markham, Ontario L3R 1E3
© 2008 AVC Multimedia Inc.
Trademark(s)[®] Registered
Marque (s)[®] de commerce enregistrée (s)
Marca(s) Registrada(s)
Printed in China

RTD317 IB V1.0 (EN)