





3D DLP® HOME-CINEMA TELEVISION MODELS

740 Series
840 Series
WD-82CB1

SUPPLEMENTAL OWNER'S GUIDE

- For questions:
 - Visit our website at www.mitsubishi-tv.com.
 - E-mail us at TVsupport@mevsa.com.
 - Call Consumer Relations at 800-332-2119 for operational or connection assistance.
- For information on **System Reset**, please see the back cover.
- To order replacement or additional remote controls or lamps, visit our website at www.mitsuparts.com or call 800-553-7278.
- MEVSA recommends that you use only genuine Replacement Lamp Assemblies purchased directly from Mitsubishi or a Mitsubishi Authorized Dealer or a Mitsubishi Authorized Service Center. See page 37 for complete instructions.

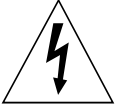

	CAUTION RISK OF ELECTRIC SHOCK DO NOT OPEN	
<p>CAUTION: TO REDUCE THE RISK OF ELECTRIC SHOCK, DO NOT REMOVE COVER (OR BACK). NO USER SERVICEABLE PARTS INSIDE. REFER SERVICING TO QUALIFIED SERVICE PERSONNEL.</p>		



The lightning flash with arrowhead symbol within an equilateral triangle is intended to alert the user of the presence of uninsulated "dangerous voltage" within the product's enclosure that may be of sufficient magnitude to constitute a risk of electric shock to persons.



The exclamation point within an equilateral triangle is intended to alert the user to the presence of important operating and maintenance (servicing) instructions in the literature accompanying the product.

MAINS DISCONNECTION: The mains plug is used as the disconnect device. The mains plug shall remain readily operable.

WARNING: To reduce the risk of fire or electric shock, do not expose this apparatus to rain or moisture.

This apparatus shall not be exposed to dripping or splashing and no objects filled with liquids, such as vases, shall be placed on the apparatus.

Cet appareil ne doit pas être exposé à des gouttes ou à des éclaboussures et aucun objet rempli d'un liquide, comme un vase, ne doit être placé sur l'appareil.

WARNING: This product contains chemicals known to the State of California to cause cancer and/or birth defects or other reproductive harm.

TV WEIGHT: This TV is heavy. Exercise extreme care when lifting or moving it. Lift or move the TV with a minimum of two adults. To prevent damage to the TV, avoid jarring or moving it while it is turned on. Always power off your TV, unplug the power cord, and disconnect all cables before moving it.

Stand Requirement

CAUTION: Use these Mitsubishi TV models only with the Mitsubishi stand model shown here. Other stands can result in instability and possibly cause injury.

TV Model	Stand Model
WD-73740, WD-73840	MB-S73A

Mitsubishi does not design, manufacture or sell matching bases for 82-inch and 92-inch model televisions. When selecting a stand, base, or other furniture to support the TV, please make sure it is designed with the appropriate dimensions for stability and to support the TV's weight plus the weight of any additional equipment you plan to store.

Custom cabinet installation must allow for proper air circulation around the television.

FCC Declaration of Conformity

Product: Projection Television Receiver
 Models: WD-73740, WD-82740
 WD-73840, WD-82840, WD-92840
 WD-82CB1
 Responsible Party: Mitsubishi Electric Visual Solutions America, Inc.
 9351 Jeronimo Road
 Irvine, CA 92618-1904
 Telephone: 1 (800) 332-2119

This device complies with Part 15 of the FCC Rules. Operation is subject to the following two conditions:

- (1) This device may not cause harmful interference, and
- (2) This device must accept any interference received, including interference that may cause undesired operation.

Note: This equipment has been tested and found to comply with the limits for a Class B digital device, pursuant to part 15 of the FCC Rules. These limits are designed to provide reasonable protection against harmful interference in a residential installation. This equipment generates, uses and can radiate radio frequency energy and, if not installed and used in accordance with the instructions, may cause harmful interference to radio communications. However, there is no guarantee that interference will not occur in a particular installation. If this equipment does cause harmful interference to radio or television reception, which can be determined by turning the equipment off and on, the user is encouraged to try to correct the interference by one or more of the following measures:

- Reorient or relocate the receiving antenna.
- Increase the separation between the equipment and the receiver.
- Connect the equipment into an outlet on a circuit different from that to which the receiver is connected.
- Consult the dealer or an experienced radio/TV technician for help.

Changes or modifications not expressly approved by Mitsubishi could cause harmful interference and would void the user's authority to operate this equipment.

Canadian Notice

For Model WD-82CB1

This Class B digital apparatus complies with Canadian ICES-003.

Cet appareil numérique de la classe B est conforme à la norme NMB-003 du Canada.

Note: Features and specifications described in this owner's guide are subject to change without notice.

For assistance call 1(800) 332-2119

Contents

Important Safety Instructions	4
--	---

1 Additional TV Features

FAV (Favorites)	5
Sleep Timer	5
ChannelView Channel Listings	6
Picture Shape and Display Formats	7
More On TV Inputs and Outputs	9
Using the TV with a Personal Computer	11
Specialized TV Connections	12
Photos and Motion Video as Composite Video	12
Using the TV with an Audio-Only Device	12
Supplemental Audio Connections (840 series)	14
Adding a Subwoofer	14
External Rear Speakers	15
Using the TV Speakers as a Center Channel	16

2 TV Menus

Main Menu	17
Picture	17
Sound	21
Captions	23
Setup	24
Inputs	27
Lock	29

3 HDMI Control of CEC Devices

Enabling HDMI Control of CEC Devices	33
HDMI Control of an HDMI A/V Receiver and Connected Devices	34
Resolving CEC Conflicts	35
Removing an HDMI Device	35
Using HDMI Control	35

Appendices

Appendix A: TV Care	36
Cleaning Recommendations	36
Care of the Remote Control	36
Lamp-Cartridge Replacement	37
Appendix B: Troubleshooting	39

Trademark and License Information	43
--	----

Warranty	50
---------------------------	----

MEVSA Internet Applications Policy	54
---	----

Index	55
------------------------	----

Lamp Replacement

When the lamp cartridge needs replacement, **replace the lamp yourself and save the cost of a service call.** See Appendix A for instructions.

To Order a Replacement Lamp Under Warranty

Visit our website www.mitsuparts.com or call (800) 553-7278. Please have television model number, serial number, and proof of purchase available.

To Order a Replacement Lamp After Warranty

Visit our website at www.mitsuparts.com or call (800) 553-7278. Please have the television model number available. Order new lamp part number **915B455011**.

Internal Fans

Internal cooling fans maintain proper operating temperatures inside the TV. It is normal to hear the fans when you first turn on the TV, during quiet scenes while viewing the TV, and for a short time after shutting off the TV. You may notice louder fan noise about 30 seconds after shutting off the TV and while using the **Bright Lamp Energy** setting.

NOTE TO CATV SYSTEM INSTALLER: THIS REMINDER IS PROVIDED TO CALL THE CATV SYSTEM INSTALLER'S ATTENTION TO ARTICLE 820-40 OF THE NEC THAT PROVIDES GUIDELINES FOR THE PROPER GROUNDING AND, IN PARTICULAR, SPECIFIES THAT THE CABLE GROUND SHALL BE CONNECTED TO THE GROUNDING SYSTEM OF THE BUILDING, AS CLOSE TO THE POINT OF CABLE ENTRY AS PRACTICAL.

Children and TV Viewing

The American Academy of Pediatrics discourages television viewing for children younger than two years of age.

Note: Features and specifications described in this owner's guide are subject to change without notice.

TV Software

- Do not attempt to update the software of this TV with software not provided by or authorized by Mitsubishi Electric Visual Solutions America, Inc. Non-authorized software may damage the TV and will not be covered by the warranty.
- Automatic software updates will be downloaded over the internet to the TV if StreamTV is set up and connected to the internet. In Canada, WD-82CB1 users can receive automatic software updates although StreamTV services are unavailable.

Important Safety Instructions

Please read the following safeguards for your TV and retain for future reference. Always follow all warnings and instructions marked on the television.

- 1) Read these instructions.
- 2) Keep these instructions.
- 3) Heed all warnings.
- 4) Follow all instructions.
- 5) Do not use this apparatus near water.
- 6) Clean only with dry cloth.
- 7) Do not block any ventilation openings. Install in accordance with the manufacturer's instructions.
- 8) Do not install near any heat sources such as radiators, heat registers, stoves, or other apparatus (including amplifiers) that produce heat.
- 9) Do not defeat the safety purpose of the polarized or grounding-type plug. A polarized plug has two blades with one wider than the other. A grounding type plug has two blades and a third grounding prong. The wide blade or the third prong are provided for your safety. If the provided plug does not fit into your outlet, consult an electrician for replacement of the obsolete outlet.
- 10) Protect the power cord from being walked on or pinched particularly at plugs, convenience receptacles, and the point where they exit from the apparatus.
- 11) Only use attachments/accessories specified by the manufacturer.
- 12) Use only with the cart, stand, tripod, bracket, or table specified by the manufacturer, or sold with the apparatus. When a cart is used, use caution when moving the cart/apparatus combination to avoid injury from tip-over.
- 13) Unplug this apparatus during lightning storms or when unused for long periods of time.
- 14) Refer all servicing to qualified service personnel. Servicing is required when the apparatus has been damaged in any way, such as power-supply cord or plug is damaged, liquid has been spilled or objects have fallen into the apparatus, the apparatus has been exposed to rain or moisture, does not operate normally, or has been dropped.



EXAMPLE OF ANTENNA GROUNDING

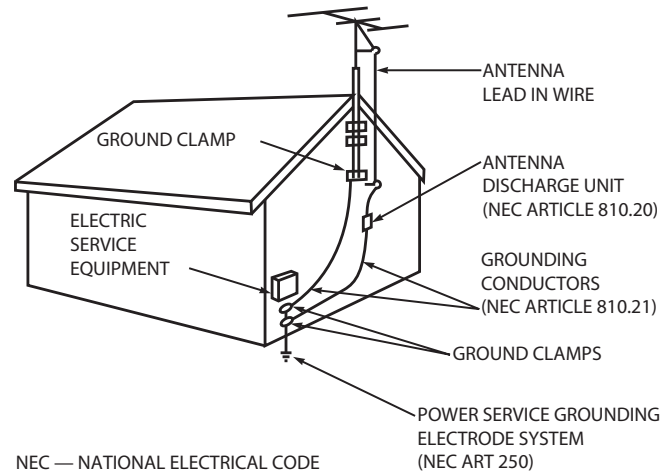

Outdoor Antenna Grounding

If an outside antenna or cable system is connected to the TV, be sure the antenna or cable system is grounded so as to provide some protection against voltage surges and built-up static charges.

Replacement Parts

When replacement parts are required, be sure the service technician has used replacement parts specified by the manufacturer or have the same characteristics as the original part. Unauthorized substitutions may result in fire, electric shock or other hazards.

1 Additional TV Features

FAV (Favorites)

The **FAV** key gives you quick access to favorite program sources. Sources can be channels from the **ANT** input or devices connected to the TV. You can store up to nine favorites.

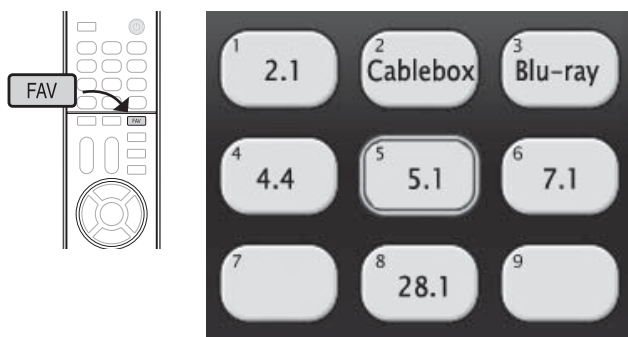

Sample Favorites menu. Switch to favorite channels or inputs using number keys.

Adding Favorites

1. Press **INPUT** and switch the TV to the input you want to add. If adding a channel, switch to the **ANT** input and tune to the channel.
2. Press the **FAV** key.
3. Move the highlight to the number position you want to assign to the channel or input.
4. Press **ENTER**.

Removing

1. While watching TV, press the **FAV** key.
2. In the **Favorites** menu, highlight the channel or input you want to remove.
3. Press **CANCEL**.

Tuning

1. While watching TV, press the **FAV** key.
2. Press the number key for the channel or input you want.

Sleep Timer

The Sleep Timer turns the TV off after the length of time you set. To set the TV to turn on at a certain time of day, see the **Setup > Timer** menu.

Setting the Sleep Timer

1. Press **SLEEP**.

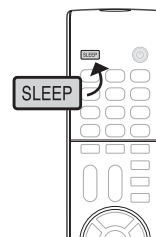

2. Press **SLEEP** additional times to increase the time in 30-minute increments up to the maximum of 120 minutes.
3. Press **EXIT** or wait five seconds without pressing any keys for the message to clear.

Viewing or Changing the Sleep Timer

1. Press **SLEEP** to display the on-screen message.
2. Press **SLEEP** additional times to change the time before the TV powers off. To cancel the Sleep Timer, press **SLEEP** repeatedly until **OFF** is displayed.

ChannelView Channel Listings

ChannelView displays program descriptions sent by broadcasters. This information may be unavailable in some areas.

About ChannelView

ChannelView™ shows memorized channels on the **ANT** input. It displays channel names and program information for digital channels. No program information is displayed for analog channels.

ChannelView allows you to set up three banks of custom channels for convenient access. You can save groups of channels by content (e.g., news, sports, children's programming) or by TV user.

Note: You must first set the TV Clock to receive correct ChannelView listings. Use the **Setup > Clock** menu.

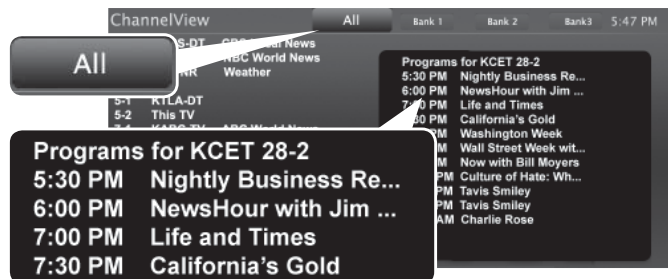

ChannelView "All" tab. Programs are listed on the right.

Using ChannelView Listings

Task	Action
Display/hide ChannelView listings (ANT input only).	Press GUIDE .
Move through channels one by one.	Press ▲ or ▼ .
Move through channels quickly.	Press and hold CH .
Jump to listings for a specific channel.	Enter the channel number. Press CANCEL once to add a dash; press CANCEL twice to clear the channel number.
Tune to a highlighted channel.	Press ENTER .
Update program information for a highlighted digital channel.	Press the INFO key (the screen may briefly go blank).
Display program descriptions, if available. The description will appear at the bottom of the screen.	<ol style="list-style-type: none"> Press ▶ to move into the program area. Press ▲▼ to move between programs.
Display more program description for the current channel (if available).	Press INFO .

ChannelView Custom Channel Banks

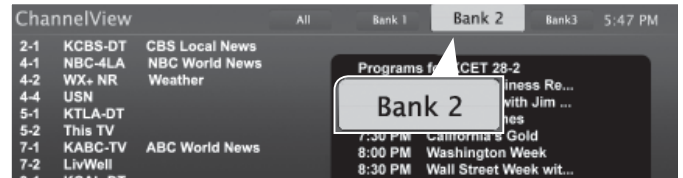

Select a channel bank to customize.

1. Press **GUIDE** to display ChannelView.
2. Press **MENU** to move the highlight to the bank header.
3. Press **◀▶** to select Bank 1, 2, or 3.
4. With the bank name highlighted, press **ENTER** to enter setup mode where you can select channels to include in the bank.

Task	Action
Move between banks	Press ◀▶ .
Move into the channel list	Press ▼ .
Add or delete a channel from the bank	<ul style="list-style-type: none"> Highlight the channel and press ENTER. A check indicates the channel has been added. Press ENTER again to clear the check and remove the channel.
Remove all channels from the selected bank	Press CANCEL .
Enter or exit setup mode	Press MENU .

5. Press **EXIT** when finished with setup.

Using Custom Channel Banks

- While watching TV, press **CH**. The TV will tune only to channels stored in the current bank.
- To change to a different channel bank:
 1. Press **GUIDE**.
 2. Press **MENU**.
 3. Press **◀▶** to highlight the desired bank.
 4. Press **EXIT**.
- To allow tuning to any channel in memory, select the **All** bank.

Picture Shape and Display Formats

Format Definitions

Use the **FORMAT** key to apply the formats described here.

Standard: The full-screen format used by HDTV signals. Use this format to display anamorphic DVDs with a 1.78:1 or 1.85:1 aspect ratio. Anamorphic DVDs with a 2.35:1 aspect ratio are displayed correctly but with top and bottom black bars. Squarish (4:3) images are stretched evenly from side to side. Available for all signals.

Expand: Enlarges the picture to fill the screen by cropping the top and bottom; useful for reducing the letter box top and bottom bars of non-anamorphic DVD images.

Zoom: Enlarges the picture to fill the screen by cropping the sides, top, and bottom to eliminate black bars.

- **480i/480p and SD 4:3 signals:** Eliminates top and bottom bars on anamorphic DVDs with a 2.35:1 aspect ratio.
- **720p, 1080i, SD 16:9, and HD signals:** Eliminates bars added to squarish 4:3 images.

Stretch: Stretches a squarish 4:3 image across the screen to display the entire image with less distortion than the Standard format.











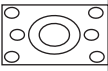

Stretch Plus: Similar to Stretch, but minimizes distortion on the sides by expanding the picture to crop off portions of the top and bottom. Use ▲▼ to adjust the vertical position of the picture.

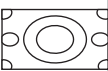
Narrow: Displays narrow 4:3 images in their original shape. Adds black side bars to fill the screen.

Wide Expand: Enlarges the picture, cropping the image on both sides. Removes or reduces black side bars added to narrow images converted to 16:9 signals for digital broadcast.

Note: All high-definition channels send widescreen (16:9) signals, but not all programming was created for the widescreen format. The broadcaster may stretch the image or add side bars to fill the widescreen area.

Effect of Mitsubishi Formats on Picture Types

Original Signal TV Display Format ↓	Non-anamorphic or SD 4:3	Anamorphic DVD
Standard	 Distorted; Not recommended.	 Recommended
Expand	 Recommended for letterbox. See Note 1.	 Distorted; not recommended. See Note 1.
Zoom	 Distorted; Not recommended. See Note 1.	 Recommended for anamorphic 2.35:1 images. See Note 1.
Stretch	 Recommended for standard broadcasts. See Note 1.	 Distorted; not recommended. See Note 1.
Stretch Plus	 Recommended for standard broadcasts. See Note 1.	 Distorted; not recommended. See Note 1.
Narrow	 See Note 1	 Distorted; not recommended. See Note 1.

Note 1: Available for 480i and 480p signals only.

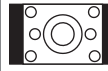
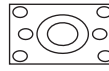
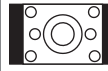
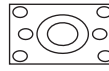
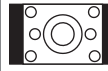
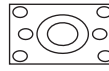
Original Signal	Display Formats						
SD 16:9 or HD Digital 720p, 1080i, 1080p Signal	<table border="1"> <tr> <td></td> <td>Wide Expand</td> <td>Recommended to remove side bars.</td> </tr> <tr> <td></td> <td>Zoom</td> <td>Recommended to remove bars from the top, bottom, and sides.</td> </tr> </table>		Wide Expand	Recommended to remove side bars.		Zoom	Recommended to remove bars from the top, bottom, and sides.
	Wide Expand	Recommended to remove side bars.					
	Zoom	Recommended to remove bars from the top, bottom, and sides.					

TV Display Formats. Press the **FORMAT** key repeatedly to see different displays for the current program. Press the **INFO** key to see the name of the format in use.

DVD Image Definitions

Image information may be stated on the DVD case. Some DVDs support both formats described below.

Anamorphic (or Enhanced for WideScreen TV) Indicates DVDs recorded to show widescreen images properly on 16:9 TV sets using the TV's **Standard** format mode (recommended).

Non-Anamorphic (or 4:3, 1.33:1, Letter Box, or Full Screen)

Indicates DVDs recorded for viewing on squarish TV screens. They may be full screen (4:3 or 1.33:1) which crops movies to fit the narrow TV, or letter box, which adds black top and bottom bars.

Status Display

Press the **INFO** key to see the on-screen status display. The most common displays are shown here.

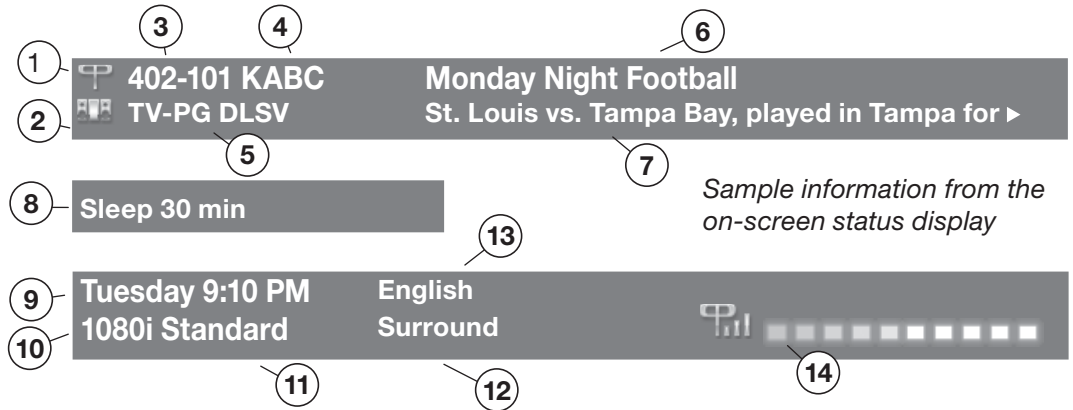
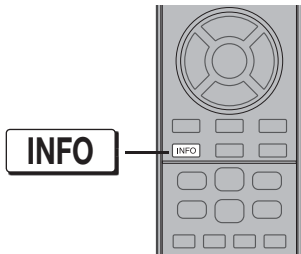

Sample information from the on-screen status display

About Channel Numbers

Channel Numbers for Over-the-Air Reception or Reception by Direct Cable

Note: All signals are automatically converted to 1080p for display.

Standard-Definition Analog Channels

Cable Reception Channel 3



480i Stretch

Receiving Standard-Definition Analog Signal (480i)

Standard-Definition Digital Channels

Over-the-Air Antenna Reception Main Channel 7 Sub-Channel 1



480i Stretch

Receiving Standard-Definition Digital Signal (SD)

High-Definition Digital Channels

Over-the-Air Antenna Reception Main Channel 7 Sub-Channel 1



1080i Standard

Receiving High-Definition Digital Signal (HD)

- | | | | | | |
|--|---------|-----|-----|------|------------|
| | Antenna | DVD | DVR | Game | Sat. Rcvr. |
| | | | | | |
- Current Input. Examples:
 - Audio Indicator. Key:

	TV speakers		External sound system		Mute
--	-------------	--	-----------------------	--	------
 - Channel number (antenna source only)
Digital channel includes major and sub-channel numbers.
 - Digital channel name (if broadcast); antenna source only.
 - V-Chip rating
 - Digital signal: Antenna source only
 - Analog signal: Antenna or **VIDEO** composite jack
 - Program name (if broadcast); digital antenna source only
 - Program description (if broadcast); digital source, antenna only. Press the **INFO** key additional times to see more of the description.
 - Sleep Timer remaining time
 - Day and time
 - Signal type being received. See "Signal Definitions" on this page.
 - Screen format in use
 - Program audio indicator (antenna source only)
 - Available language (digital source, antenna only)
 - Signal-strength indicator (digital source, antenna only)

Signal Definitions

480i: Standard-definition, older type interlaced signals from the **ANT**, composite **VIDEO**, component **Y Pb Pr**, or **HDMI** jacks.

480p: Standard-definition progressive-scan signals on the **ANT**, component **Y Pb Pr**, or **HDMI** jacks.

720p and 1080i: High-definition signals received through the **ANT**, component **Y Pb Pr**, or **HDMI** jacks. These signals are always 16:9 (widescreen), but may contain embedded 4:3 images with sidebars.

1080p: High-definition signals from a PC, Blu-ray player, or some satellite and set-top boxes; **HDMI** inputs only.

More On TV Inputs and Outputs

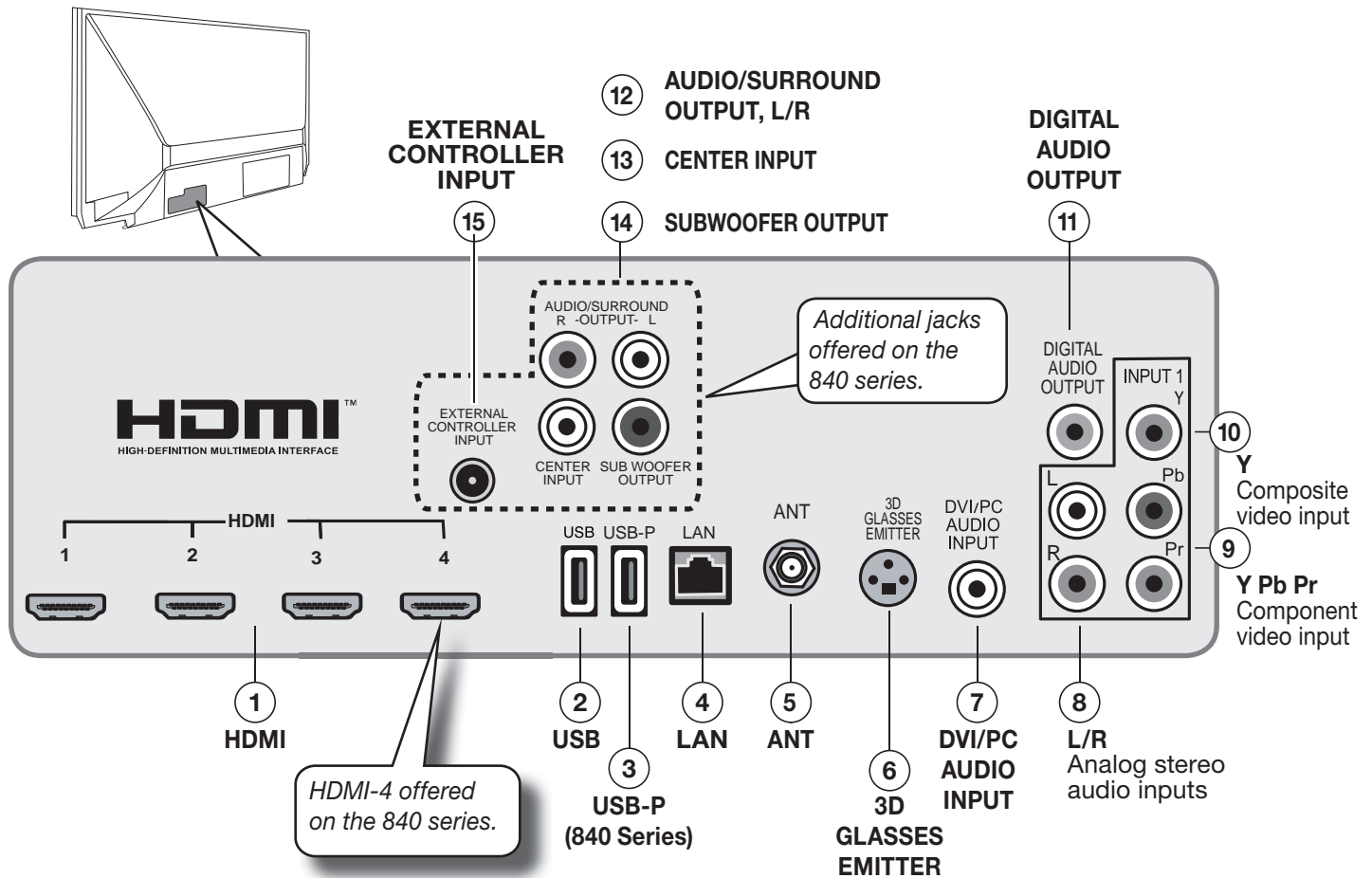

The Basic Owner's Guide supplied with your TV contains connection diagrams showing how to use most of these jacks.

1. HDMI® Inputs (High-Definition Multimedia Interface)

The HDMI inputs support uncompressed standard and high-definition digital video formats, bitstream Dolby Digital 5.1, and PCM digital stereo audio. These inputs are HDCP (High-Bandwidth Digital Copy Protection) compliant.

Mitsubishi recommends you use high-speed HDMI cables to connect newer source devices incorporating HDMI technology. High-speed cables bring you the full benefits of Deep Color.

These HDMI inputs can also accept digital DVI video signals. To connect a device's DVI output to the TV's HDMI input, use an HDMI-to-DVI adapter or cable plus an analog audio cable. Connect the audio cable to the **DVI/PC AUDIO INPUT** jack on the TV to receive audio from your DVI device.

Use the HDMI inputs to connect to CEA-861 HDMI compliant devices such as a high-definition receiver or DVD

player. These inputs support 480i, 480p, 720p, 1080i, and 1080p video formats.

The TV's HDMI inputs are compatible with many DVI-D and HDMI computer video signals.

HDMI Cable Categories

HDMI cables are available as Standard and High-Speed types.

- **High-Speed HDMI Cables.** Blu-ray players, newer DVD players, video games, 3D content, and set-top boxes require High-Speed HDMI cables, suitable for clock frequencies up to 340 MHz or data rates of up to 10.2 gigabits per second. Use high-speed cables for 1080p HD signals carrying extended color encodings (i.e., 30 or more bits, also called Deep Color). High-Speed HDMI cables are also suitable for standard HDTV signals.
- **Standard HDMI Cables.** Standard HDMI cables may be unmarked. They are suitable for standard HDTV 720p, 1080i, and 1080p signals with 8-bit color depth. Use Standard HDMI cables for clock frequencies up to 74.25 MHz or data rates of up to 2.23 gigabits per second.

More On TV Inputs and Outputs, continued

2. USB

- Use for a wireless network adapter to receive StreamTV internet content.
- The USB port can also serve as a standard USB 5-volt, 500-milliamp power output to power an accessory device.

3. USB-P (Power Only)

840 Series. Standard USB 5-volt, 500-milliamp power output you can use to supply power to an accessory device. See page 14.

4. LAN

Use the **LAN** Ethernet jack for streaming internet video to the TV.

5. ANT (Antenna)

Connect your main antenna or direct cable service (without a cable box) to **ANT**. The **ANT** input can receive digital and analog over-the-air channels from a VHF/UHF antenna or non-scrambled digital/analog cable source.

6. 3D GLASSES EMITTER

Use this jack for the special synchronization emitter supplied with some 3D glasses. The emitter sends out an infrared signal that synchronizes your 3D glasses with the screen display.

7. DVI/PC AUDIO INPUT

Connect a DVI device to one of the TV's HDMI inputs and use this jack to send analog audio to the TV.

8. L/R (INPUT 1 audio)

Analog stereo inputs for use in conjunction with adjacent composite or component video jacks.

9. Y Pb Pr (Component Video)

Analog video inputs able to accept high-definition video from a high-definition source device. Use the adjacent **R** and **L** inputs if you wish to send audio to the TV speakers.

10. Y (Composite Video)

Analog standard-definition video inputs. Use the adjacent **R** and **L** inputs if you wish to send audio to the TV speakers.

11. DIGITAL AUDIO OUTPUT

This output sends Dolby Digital or PCM digital audio to your digital A/V surround sound receiver. Incoming analog audio is converted by the TV to PCM digital audio. If you have a digital A/V receiver, this is the only audio connection needed between the TV and your A/V receiver.

12. AUDIO/SURROUND OUTPUT, L/R

840 Series. Provides analog audio output of the current program. Use to:

- Send audio to an analog A/V surround sound receiver or stereo system.
- Send a rear surround sound channel to an external amplifier or self-powered speakers. See page 15.
- Send audio to headphones. Set **Sound > Global > Analog Audio Out** to **Variable**.

Digital audio from digital channels and HDMI devices is converted to analog audio by the TV for output on these jacks.

13. CENTER INPUT

840 Series. Connect your A/V receiver's center channel output to this input to have the TV speakers complement your external sound system with center-channel sound. Set **Sound > Global > Center Channel** to **On** to enable this input. See "Using the TV Speakers as a Center Channel," page 16.

14. SUBWOOFER OUTPUT

840 Series. Connect a powered subwoofer to this input to complement effects from the TV's speakers. Set **Sound > Global > Subwoofer** to **On** to enable this output (see "Adding a Subwoofer," page 14).

15. EXTERNAL CONTROLLER INPUT

840 Series. Accepts control signals from an external controller when set up by your professional installer. The controller should send electronic versions of remote control IR commands.

Using the TV with a Personal Computer

Connecting a Computer to the TV

Use one of the connection methods listed below based on your computer's output.

Computer Graphics Output	Computer Graphics Connection	Audio Connection
Digital DVI	DVI-to-HDMI cable or an HDMI cable with a DVI-to-HDMI adapter	Audio cable with mini-plugs
HDMI	HDMI-to-HDMI cable	No additional audio connection is required.

IMPORTANT

This TV accepts digital computer graphics signals only. This TV is not compatible with VGA (analog) computer signals.



1. Connect the computer's digital video output to one of the TV's HDMI jacks. See the connection diagrams on this page for the method suited to your equipment.
 2. Connect the computer's audio output using one of these options:
 - For digital DVI video signals, connect the analog audio output to the TV's **DVI/PC AUDIO INPUT** jack.
 - For HDMI signals, no additional audio connection is required.
- Note:** If you are unable to hear audio from the computer, there may be an incompatibility in the computer's hardware, software, or internal settings. Consult a trained computer technician for advice.
3. Power on the TV and computer. The TV will detect the connection and display the **New Device Found** screen.
 4. In the **New Device Found** screen, press ▲ ▼ to highlight **PC** in the list of device types. It is important to use the name **PC** so that the TV processes the PC signal correctly.
 5. Highlight **EXIT** and press **ENTER** to close the **New Device Found** screen.

Note: If your computer provides digital audio output you can connect it directly to a digital A/V receiver and bypass the TV.

HDMI Connection

Mitsubishi recommends using high-speed HDMI cables to connect newer devices incorporating HDMI technology.

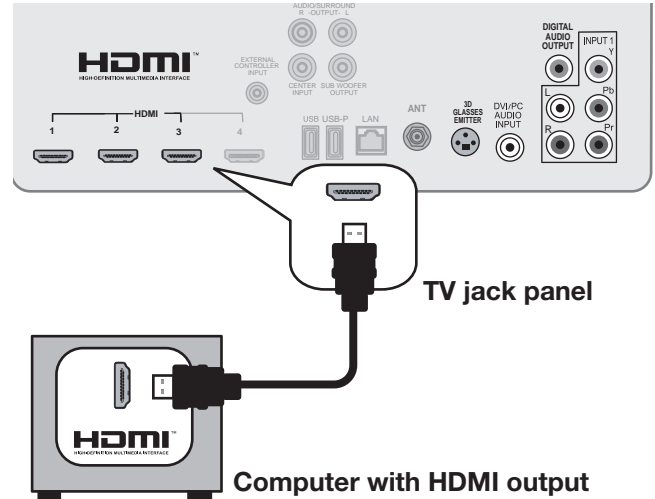

An HDMI-to-HDMI connection carries all video and audio on a single cable.

DVI Video Connection

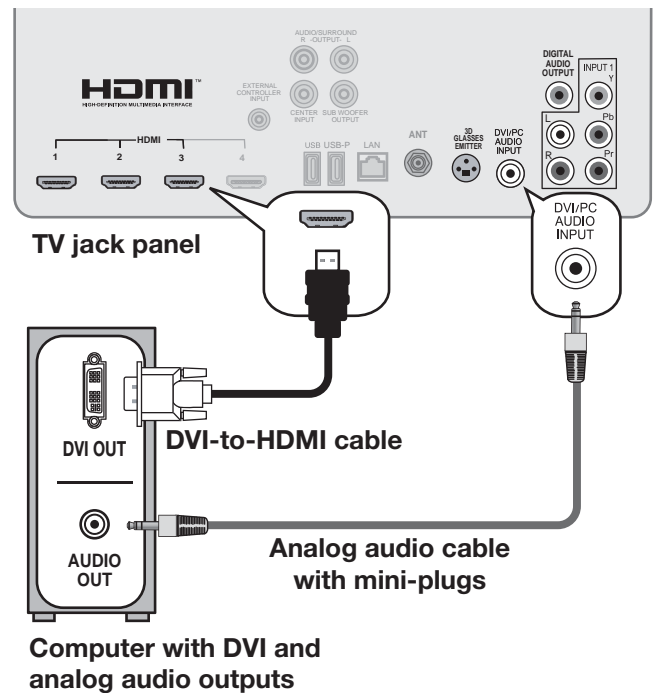

A DVI connection from a personal computer requires a separate audio connection.

Specialized TV Connections

Photos and Motion Video as Composite Video

Connect the camera to the TV using a composite video cable and control the slide show or movie through the camera. The display resolution will be standard-definition (480i).

1. Refer to the owner's manual supplied with the camera for instructions needed for this setup.
2. Set the camera's output signal type to **NTSC** and put the camera into playback mode.
3. With the camera still turned on, connect your digital camera's composite video cable (usually yellow) to the TV's **Y** composite video jack. To hear audio, connect the camera's audio output cable to the audio **L** jack.

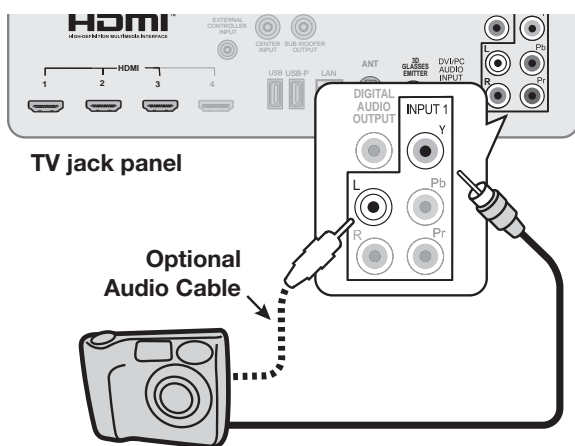

Camera connection using a composite video cable

4. When the **New Device Found** screen displays, assign the name **Camcorder**.
5. Press **EXIT** to close the **New Device Found** screen.
6. If viewing photos, control the slideshow from the camera. Advance through the images manually or check if the camera can advance automatically.

Using the TV with an Audio-Only Device

To use the TV speakers to listen to an audio device such as an MP3 or CD player with analog output, follow these steps.

1. Insert an unused RCA-style connector into the **Y** composite video jack. The presence of this connector activates the TV's auto-detection.
2. When the TV detects the video connector, it will display the **New Device Found** screen. Name the new input **CD/Audio** or **MP3 Player**.
3. Connect left (white) and right (red) audio cables from **AUDIO OUT** on the device to **L** and **R** on the TV.
4. Keep the connector in the **Y** jack while using the audio-only device.

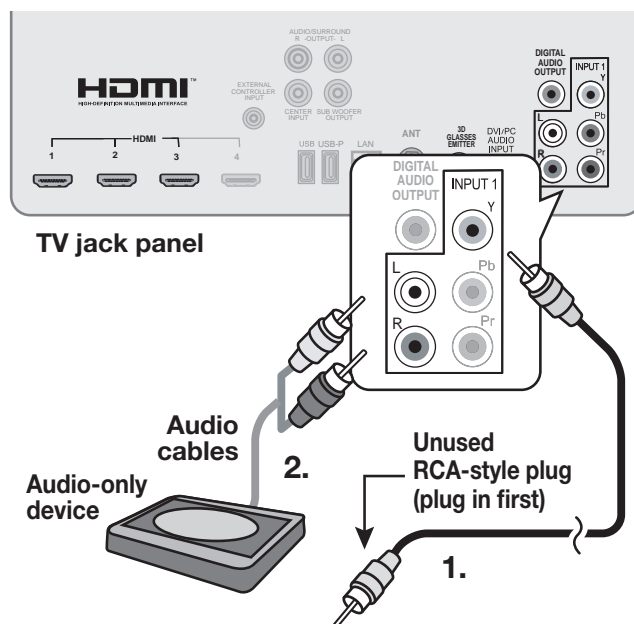

Computer Video Adjustments

1. Power on the computer.
2. Select **PC** from the **Input Selection** menu. To do this, press **INPUT** to open the **Input Selection** menu, move the highlight to the PC icon, and press **ENTER**.
3. Working from the computer, change the resolution of the computer image. View the computer image on the TV and maximize the computer resolution while maintaining a suitable aspect ratio for the image.
4. Press **FORMAT** repeatedly to find the picture shape best suited to the image. See the chart on this page showing how different computer resolutions can be displayed on the TV.
5. Perform TV video adjustments. Press **VIDEO** repeatedly to access video-adjustment options.

Tip

Set the computer's screen saver to display a pattern after several minutes of inactivity. This acts as a reminder that the TV is powered on.

Distortion in Computer Images

Computer images may show distortion when viewed on the TV, e.g., lines that should be straight may appear slightly curved.

Image Resolution

Your Mitsubishi TV can display the resolutions shown in the chart from standard VGA (640 x 480) through 1920 x 1080 signals at a refresh rate of 60 Hz.

In most cases, the computer will select the best resolution match to display on the TV. You can override this setting if you wish. Refer to your computer operating system's instructions for information on changing the screen resolution.

You may need to restart the computer for changes to take effect.

Computer Display Formats

Press **FORMAT** repeatedly to cycle through the TV displays available for your computer's video signal.

Computer Signal		As Displayed on TV Screen		
Original Format		4 X 3 Standard	16 X 9 Standard	Zoom
VGA 640 X 480				
SVGA 800 X 600				

Original Format		Standard	Zoom
XGA 1024 X 768			
PC 720p 1280 X 720			
WXGA 1360 X 768			
SXGA 1280 X 1024			

Original Format		Standard	Reduce
PC 1080p 1920 X 1080			

Supplemental Audio Connections (840 series)

Add a subwoofer to complement the TV's speaker array or use the TV's speakers as a center channel for your external sound system.

Adding a Subwoofer

Add a subwoofer to complement the TV speakers with a fuller bass sound.

- After connecting a subwoofer, you must enable the TV's subwoofer output in the TV's **Sound** menu. Go to **Sound > Global > Subwoofer** and set it to **On**.

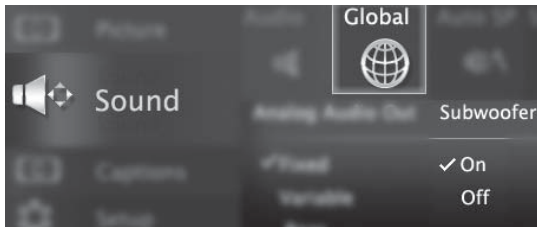

- To control subwoofer volume
 - Press the **AUDIO** key and then press **▼** to find the subwoofer volume slider. Press **◀ ▶** to change the volume.
 - Open the **Sound > Audio** menu. Highlight **Subwoofer** and press **◀ ▶** to adjust. Press **MENU** to return to the **Sound > Audio** menu.

Subwoofer with Audio Cable

Connect the subwoofer directly to the TV's **SUBWOOFER OUTPUT**.

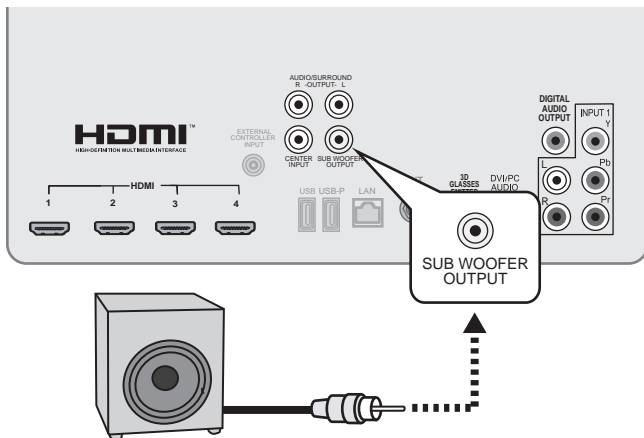

Subwoofer with audio connection to TV.

Wireless Subwoofer

Mitsubishi recommends Polk Audio Wireless Subwoofer model PSW i8m. The transmitter module can be conveniently powered from the TV's USB power port. Connect an audio cable to the transmitter to supply audio from the TV's **SUBWOOFER OUTPUT**.

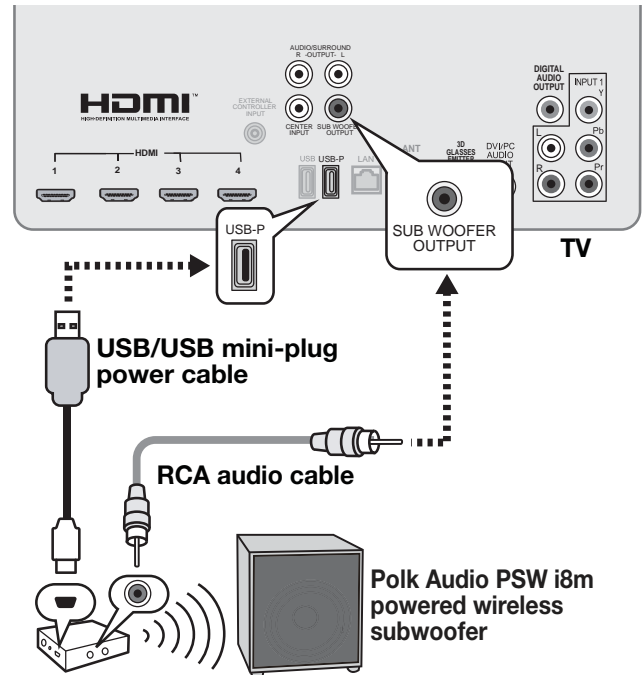

Setup to send audio signals wirelessly to the subwoofer.

Supplemental Audio Connections (840 series), continued

External Rear Speakers

You may wish to supplement surround sound from the TV with external rear speakers. External speakers can fill in rear sound if your room lacks a rear wall suitable for sound reflections. Mitsubishi recommends Polk Audio's F/X Wireless Surround system.

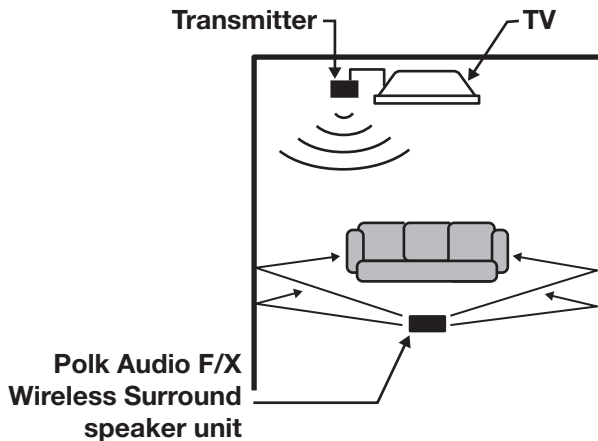

Sample layout using an external speaker unit in a room without a back wall suitable for rear sound reflections

1. Position the external speakers as needed for rear sound.
2. Connect analog audio output from the TV to the Polk Audio F/X Wireless Surround transmitter.
3. Power on the TV, speakers, and transmitter.
4. Set **Sound > Global > Analog Audio Out** to **Rear**.

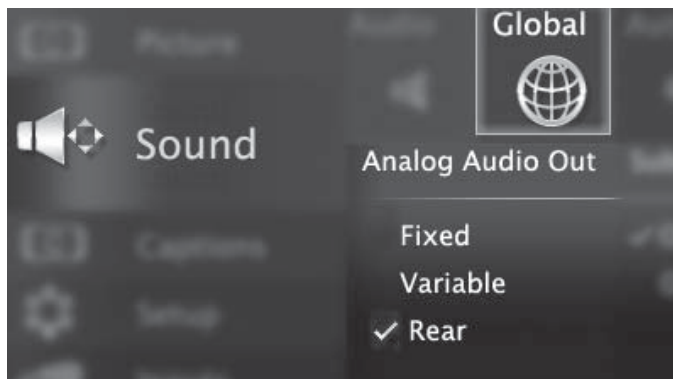

5. Adjust the sound output. Go to the **Sound > SoundPro > CUSTOM** menu.
 - a. Adjust beam angles for the left, right, and center beams.
 - b. Adjust volume levels for all audio beams, including the left and right surround beams.
6. Play sample audio to check the sound. Repeat any of the adjustments as needed.

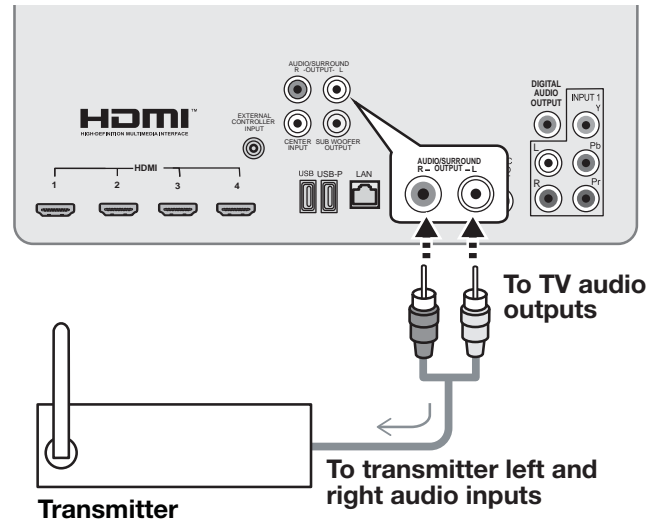

Connecting the transmitter to the TV

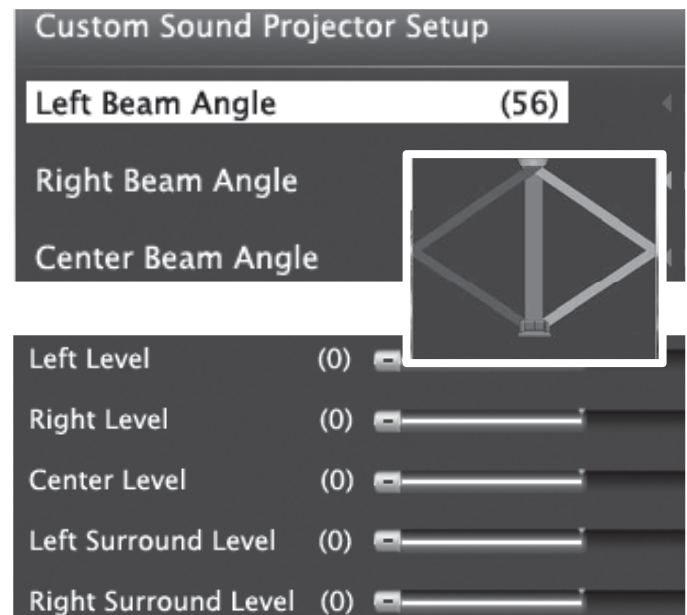

Sound Projector adjustments when using external rear speakers.

Supplemental Audio Connections (840 series), continued

Using the TV Speakers as a Center Channel

If using an external surround sound system, you can use the TV's speakers to provide center channel sound. Your A/V receiver must have a center channel pre out that can supply an amplified center-channel signal to the TV.

1. Connect your A/V receiver's HDMI output and center channel pre out to the TV as shown.

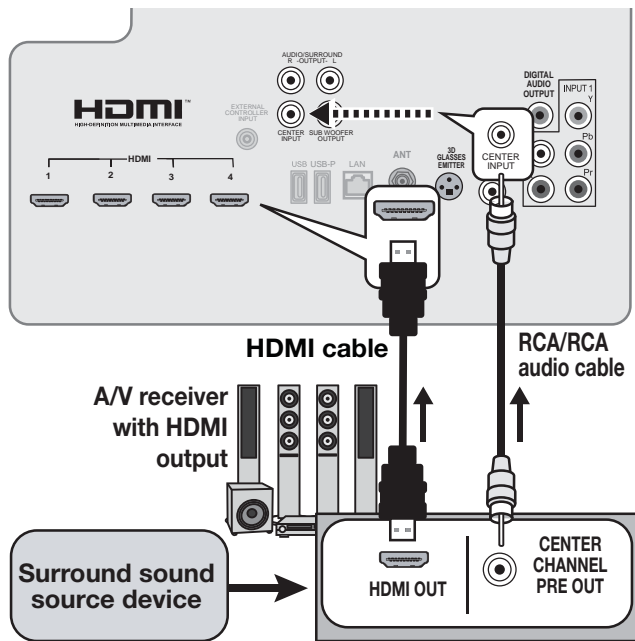

2. Turn on the A/V receiver's center channel pre out if needed. See the A/V receiver's instruction manual.
3. Enable the TV's center channel mode. Press the **AUDIO** key and press ▼ to display the **TV Speakers** option. Press ► to select **Center**.
4. Compare the center channel volume from TV's speakers to the rest of the sound system. If the center channel volume needs adjustment,
 - a. Press **AUDIO** and press ▼ to display the **Center Level** volume slider.
 - b. Adjust TV speaker volume using the ◀ ► keys.
 - c. Compare the center channel volume to the rest of the sound system. Repeat this adjustment if needed.

2 TV Menus

Main Menu

Press **MENU** on the remote control to open the main menu.

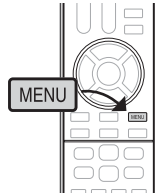

	Picture	Picture settings	17
	Sound	Sound settings	21

	Captions	Closed captions on/and off; caption displays	23
	Setup	Basic TV setup	24
	Inputs	Name assignments for TV inputs, HDMI Control setup	27
	Lock	Setting a pass code and restrictions on TV use. Disabling the control-panel buttons.	29



Picture

Assign a name to the current TV input before making video adjustments (use the **New Device Found** or **Inputs > Name** menu). Adjustments will be reset to the defaults if you rename the input after making adjustments.

Picture > Video



Settings in this menu are saved for the current input only. Press ◀ ▶ to make changes and then press **MENU** to return to the menu screen.

To make Video adjustments while watching TV and without using the menu:

1. Press the **VIDEO** key.
2. Press ▲ ▼ to select a video option.
3. Press ◀ ▶ to change the setting.

Picture Mode	Brilliant	For use under bright light; unavailable when the current input is named Game or PC .	Set the Picture Mode first before changing other video settings, as some settings are stored independently for each Picture Mode. Use Picture Modes to get the best image under different viewing conditions.
	Game	Optimizes picture and video processing for gaming consoles. Available only when the name of the input is Game or PC .	
	Bright	For most daytime viewing	
	Natural	For most nighttime viewing	
ADV1, ADV2			
	840 Series: ISF Day/3D, ISF Night/2D	Advanced Picture Modes. Contact your professional installer for setup. See page 19 for an overview.	
Contrast	<ul style="list-style-type: none"> • Low contrast shows a variety of shades in darker images • In most home lighting situations, medium contrast looks best. • High contrast shows darker images more uniformly black and makes colors appear more vibrant. High contrast is good for brightly lit environments. 		Adjusts the white-to-black level Settings are stored independently for each Picture Mode.

**Picture, continued**

Brightness	Adjusts overall picture brightness. Settings are stored independently for each Picture Mode.		
Color	Adjusts overall color intensity from monochromatic to fully saturated.		
Tint	Adjusts the red-to-green ratio.		
Sharpness	Adjusts picture detail and clarity.		
Color Temperature	High	Gives white images a cool cast. May provide the most realistic picture under bright lighting.	Adjusts the white balance. Settings are stored independently for each Picture Mode.
	Low	Gives white images a warm cast. Natural/Color Temp at the low setting displays video at approximately the 6500K industry standard for NTSC pictures.	
Video Noise	High, Medium, Low, Off	<ul style="list-style-type: none"> • High. For poor-quality signals. • Medium. For moderate noise reduction. • Low. For good-quality signals. • Off. Leaves the picture unaltered. 	Reduces minor noise (graininess) in the picture.

Picture **Picture+** (Picture Plus)

Screensaver	On, Off	Select On to display a screensaver pattern while playing an audio-only input. To use this feature, the input must either <ul style="list-style-type: none"> • Be named as an audio source (e.g., CD, MP3 Player) or • Be the antenna input tuned to an audio-only signal.
Film Mode	Auto, Off	480i and 1080i signals only. In Auto , the TV automatically detects and applies film-decoding correction to movies filmed at 24 frames per second. Try the Off setting if images show many jagged edges. Setting saved by input.
Test Picture		Press ENTER to display a test picture. Use as a reference picture for high-definition images only.

Picture **Reset**

- Resets sound and picture adjustments for the current input. Highlight the **Reset** icon and press **ENTER** twice to perform reset.
- **Reset** has no effect on universal settings (**Balance, Listen To, Language**) or on **Advanced** Picture Mode settings.



Picture, continued

Picture Perfect



(PerfectColor, 840 Series)

PerfectColor Sliders Adjusts the saturation (intensity) of six colors for the current image source.

PerfectTint Sliders Adjusts six hues for the current image source

Using PerfectColor:

Highlight the Perfect icon and press **ENTER** to display the **PerfectColor** menu. Settings are retained independently for each TV input.

Using PerfectTint:

- To switch between PerfectColor™ and PerfectTint™ adjustments, highlight **PerfectColor/PerfectTint** and press ◀ ▶.
- Press ▲ ▼ to move from one color bar to the next.
- Press ◀ ▶ to change settings.
- Press **CANCEL** to restore default settings.
- Press **MENU** to return to the main menu.

Picture Advanced



Picture > Advanced allows you to save highly customized picture adjustments for each input. **Mitsubishi recommends these adjustments be made only by a trained professional installer.**



1. Press **MENU**. Under **Picture**, highlight the **Advanced** icon and press **ENTER**.
2. With **Picture Mode** (the first option) highlighted, press **ENTER** to change from blank (undefined) to **ADV1** (daytime settings) or **ADV2** (nighttime settings).
3. Use ▲ ▼ to highlight an option you wish to change and press **ENTER** to see the adjustment display.
4. Press ◀ ▶ to change settings.
5. Use ▲ ▼ to navigate to additional options and press ◀ ▶ to change settings.
6. Press **MENU** to return to the **Picture > Advanced** menu and save the adjustments for the current input. Press **EXIT** to close the menu.

Saving Custom 3D Settings

This menu can be used to create a custom Picture Mode for viewing 3D content. Mitsubishi recommends saving 3D settings under the name **ADV1** and 2D settings under the name **ADV2**.

To create a custom 3D picture mode:

- The TV must be receiving a 3D signal
- One of the TV's 3D Source Formats must be selected
- You must be wearing 3D glasses matched to the emitter in use.

Locking Custom Picture Mode Settings

840 Series. Once set up, you can protect custom Picture Mode settings with a pass code. With the **Picture > Advanced** menu displayed, highlight the Picture Mode name and press keys

7 4 1 5 3 6 9 ENTER

Once locked, the name of each Picture Mode changes:

ADV1 is locked as **ISF Day/3D**

ADV2 is locked as **ISF Night/2D**

Use the same key sequence to unlock the settings and make changes.

To Use a Custom Picture Mode at a Later Time

- Press **VIDEO** and use ▲ ▼ to find the Picture Mode option. Press ◀ ▶ to select the desired mode.
- Press **MENU** and go to **Picture > Video > Picture Mode** and select the desired mode.

To Return to the Default Values for Advanced

Display the **Picture > Advanced** menu and:

1. Highlight the name of the **Advanced** mode to change.
2. Highlight **RESET Pic Mode** and press **ENTER**. You must perform the reset separately for both **ADV1** and **ADV2**.



Picture, continued

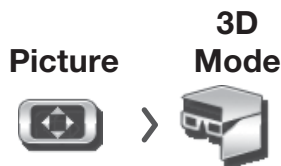

Source Format	Off	<ul style="list-style-type: none"> Overrides the 3D processing of any HDMI 1.4a-compliant 3D signal and displays the signal in 2D instead. Allows access to some of the 2D picture adjustments that are hidden when the TV's 3D mode is set to Automatic. 	
	Automatic	<ul style="list-style-type: none"> When the TV receives a 3D signal from an HDMI 1.4a-compliant device, forces the TV automatically into 3D mode and selects the correct 3D format. When the TV receives a normal 2D signal, makes the TV automatically exit 3D mode. Not effective with checkerboard 3D signals. Manually select Checkerboard when needed. 	
	Side-by-Side Top/bottom Checkerboard	<ul style="list-style-type: none"> 3D format choices for use with 3D signals that are not HDMI 1.4a compliant. When the TV receives a 3D signal that is not HDMI 1.4a compliant, you must manually select a 3D format here based on the type of 3D signal being received. Return the TV to Automatic or Off at the end of the non-compliant 3D program. If an HDMI 1.4a compliant signal is received, the TV will automatically override any manual 3D selection. 	
	2D+ Depth	When active, generates a simulated 3D image from an ordinary 2D signal.	
Glasses Emitter Internal	Standard, Reverse, Off	<ul style="list-style-type: none"> For use with the TV's internal emitters Select the Off setting if you notice IR interference with other devices. 	Use the Standard or Reverse setting to synchronizes left/right images to work with your 3D glasses.
Glasses Emitter External	Standard, Reverse	For use with an external emitter connected to the TV's 3D GLASSES EMITTER jack.	
Depth		<ul style="list-style-type: none"> Available only when Source Format is set to 2D+ Depth. Highlight the icon and press ENTER to display the adjustment screen. Allows adjustment of the 3D effect from a flatter image to one with more depth. 	
DLP Link	Standard, Reverse, Off	<ul style="list-style-type: none"> For use with DLP Link. Select the Off setting if you are not using DLP Link glasses. 	Use the Standard or Reverse setting to synchronizes left/right images to work with your 3D glasses.

Notice Concerning Format Compatibility

The Mitsubishi TVs will support the mandatory HDMI 1.4a 3D signals intended for the United States. Specifically, the TVs will support the 3D signals known as Frame Packing 1080p/24Hz and 720p/60Hz (primarily from Blu-ray players and gaming consoles), Side-by-Side in 1080i/60Hz, 1080p/24Hz/30Hz/60Hz and 720p/60Hz, Top/Bottom in 1080p/24Hz and 720p/60Hz, and Checkerboard 1080p/60Hz. However, there may be some 3D sources that are not compatible with the TVs.

In all cases: (1) 3D sources must connect to the TVs using the HDMI inputs or via StreamTV™ Internet Media; and (2) Active Shutter 3D glasses that match the TV's internal synchronization emitter, or Active Shutter 3D glasses with their own external matching synchronization emitter connected to the rear of the TV or DLP Link Active Shutter 3D glasses are required in order to view 3D content.

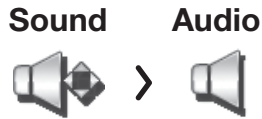
 **Sound**

Settings in this menu are saved for the current input only with the exception of **Balance**, which applies to all inputs. Press ◀ ▶ to make changes and then press **MENU** to return to the menu screen.

To make Audio adjustments while watching TV and without using the menu:

1. Press the **AUDIO** key.
2. Press ▲ ▼ to select an audio option.
3. Press ◀ ▶ to change the setting.

TV Speakers	On	Turns on the internal TV speakers.
	Off	Turns off the internal TV speakers so you hear sound only from a connected A/V receiver. Note: When you disconnect an A/V receiver, be sure to change the Sound setting to TV to hear sound from the TV speakers.
	Center	840 Series. Makes the TV's speaker array act as a center channel. See "Using the TV Speakers as a Center Channel," page 16. Notes: <ul style="list-style-type: none"> • When Center is active, the subwoofer output is muted even if set to On. • To de-activate the center channel, change TV Speakers to On or Off.
Center	[Center channel level adjustment]	840 Series. Adjusts the volume level of the TV speaker array when used as a center channel. Note: Set TV Speakers to Center to make this adjustment available.
Bass		Controls volume of low-pitched sound from the TV speakers.
Subwoofer	[Subwoofer level adjustment]	840 Series. Adjusts the volume level of a connected subwoofer. Note: Set Sound > Global > Subwoofer to On to make this adjustment available.
Treble		Controls volume of high-pitched sound from the TV speakers.
Balance		Controls audio balance between the right and left TV speakers
Sound Mode	Stereo	No special audio effects from the TV speakers
	Surround	Modifies audio from the TV speakers. <ul style="list-style-type: none"> • For monaural (non-stereo) programs, creates a simulated stereo effect. • For stereo programs, creates a simulated surround sound effect. • The TV's speaker array plays surround sound if available.
	Music	840 Series. Optimizes the TV's speaker array for music listening.
	Night	840 Series. Focuses the TV's speaker array to a single point to limit sound heard by others outside the room. Press ENTER to adjust the focal point (Night Angle).
Level Sound	On, Off	Reduces differences in sound volume between programming segments, such as the difference between regular broadcast programs and commercial segments.
Listen To (applies only to analog channels from the ANT input)	Stereo	The TV plays stereo broadcasts in stereo and mono broadcasts in mono. The word Stereo is displayed when you tune to a channel broadcasting in stereo.
	Mono	Reduces background noise. Use when receiving a weak stereo audio signal. All audio is played as mono.
	SAP (Second Audio Program)	Selects an additional monaural sound track not audible during normal TV viewing. The SAP signal might be related to the program (such as a sound track in a foreign language), or it might be unrelated (such as a weather report). If an SAP signal is broadcast, the letters SAP are displayed when you tune to the channel.



Sound, continued

Sound Global



840 Series. These settings affect audio from the **AUDIO/SURROUND OUTPUT** jacks.

Analog Audio Out

Fixed Use with an analog A/V receiver. Control volume from the A/V receiver. The volume of the audio output signal is fixed and is unaffected by the TV's volume control.

Variable Use with headphones. Adjust headphone volume using the TV's volume controls. When set to **Variable**, the audio output signal is adjustable from the TV's volume controls.

Rear Sends left and right rear audio to external speakers. Use when supplementing the TV's speaker array with external rear speakers. See "External Rear Speakers," page 15.

Subwoofer Select **On** to turn on audio to a connected subwoofer. Set to **Off** if no subwoofer is connected.

Sound Auto SP



840 Series. Performs auto calibration of the Sound Projector speaker array. Use of this menu is explained in the Basic Owner's Guide supplied with the television.

Sound SoundPro



840 Series. Lets you set up the Sound Projector speaker array manually. Use of this menu is explained in the Basic Owner's Guide supplied with the television.

Captions

Captions on Digital Channels

The TV can decode captions from the **ANT** input only. Broadcasters can send up to six different captioning selections or can send analog captions for a program that originated in analog format. A TV station may broadcast only one or two types of captions or none at all.

Captions on Analog Channels

The TV can decode captions from the **ANT** input and the composite **VIDEO** jacks. Broadcasters can send either standard closed captions or text service. Standard closed captions follow the dialogue of the program and display in a small section of the screen. Text-service closed captions often contain information such as weather or news and cover a large portion of the screen.

IMPORTANT

- Analog text-service options display a large black or gray box on the screen when no caption signal is being broadcast.
- The content of captions is determined by the broadcaster. If captions show strange characters, misspellings, or odd grammar, it is not a malfunction of the TV.
- Closed-caption signals are not available through HDMI or component jacks. See the menus for devices connected to these inputs for closed-caption decoding.

Captions Services



Service	On if Mute, On, Off	On if Mute: Displays digital closed-caption signal Caption 1 (digital) or CC1 (analog) when audio from the TV speakers is muted. While watching TV, press MUTE to turn closed captions on/off.
Digital	Caption 1–Caption 6	Caption signals sent by the broadcaster.
Analog	CC 1–CC 4 Text 1–Text 4	<ul style="list-style-type: none"> • CC 1–CC 4. Standard closed-caption signals • Text 1–Text 4. Text-service signals

Captions Font



These choices apply to digital captions only.

Style	As Broadcast or choice of font styles (digital captions only)	As Broadcast changes settings to those selected by the captions provider, or, if none, to the TV's own caption defaults. Use one of the font styles to give digital captions a custom appearance.
Size	Large, Medium, Small	Large is recommended.

Captions Color



Font	White, Black, Magenta, etc.	Recommendations for digital captions: <ul style="list-style-type: none"> • A white font on a black translucent background makes an easy-to-read combination. • Use contrasting colors for captions and background.
Opacity	Translucent, Opaque, Flashing, Transparent	
Background Color	White, Black, Magenta, etc.	
Background Opacity	Translucent, Opaque, Flashing, Transparent	

Setup

Setup Language



Menu	English Spanish	Displays on-screen menus in either English or Spanish.
Antenna Digital Audio	Selects the current language for a digital program from the ANT input. A digital program may include up to seven language choices or no language choice.	

Setup Clock



Set the TV clock to:

- Use the TV Timer to power on the TV automatically at a time you specify
- Receive correct updates to ChannelView listings
- Lock the TV by time

Note:

- When the Daylight Saving Time change occurs, you must open this menu and set the TV's clock ahead or back.
- You must reset the TV's clock after an interruption of power such as unplugging the TV's power cord.

Time	Highlight the Clock icon and press ENTER or ▼ to highlight the time. To edit time and date:	
	<ul style="list-style-type: none"> • Press ENTER to select the item to change. • Press ▲▼ to change values. Press ENTER to confirm entries. • Press ◀▶ to move to another column. 	
Date		
Time Zone	Eastern, Central, Mountain, Pacific , etc. The correct time zone is required for accurate ChannelView updates.	
Daylight Savings	Off, On	Select the setting for your area (required for accurate ChannelView updates).

Setup Timer



The Timer tells the TV to power on automatically at a time you set. Use this menu to set a day, time, input, and channel for the Timer. If the TV is already on at the set time, the TV will automatically change to the designated channel or input.

- The TV clock must be set before you can use the Timer feature.
- As a reminder that the TV Timer is set, the TV **POWER** indicator flashes slowly while the TV is powered off.
- When the Timer turns on the TV, press any key on the remote control to keep it from turning off after five minutes.

Timer	On, Off	Select On to enable the Timer.
Day	Daily, Mon-Fri , (every) Sunday , (every) Monday , (every) Tuesday , etc.	Select the day or days of the week for the Timer to turn on the TV.
Time	To set the time for the TV to come on:	
	<ol style="list-style-type: none"> 1. Highlighted the time and press ENTER. 2. Press ▲▼ to change values. Press ENTER to confirm entries. 	
Input	Ant, DVD, VCR , etc. Select the input you want displayed when the TV comes on. Choose from the defined and enabled inputs that appear in the Input Selection menu.	
Channel	If the source is the ANT input, press ▲▼ to select a channel number or press and hold to scroll quickly.	



Setup, continued

Setup Channel



Ant Air, Ant Cable

You must perform a channel scan to receive digital channels. The scan searches for broadcast channels and adds them to TV memory. To start channel scan:

All Channels, Add only new channels

1. Highlight one of the input selections based on your connection to the **ANT input**:
 - **Air** when connected to an indoor or outdoor antenna.
 - **Cable** when connected to direct cable (no cable box)
2. Select the scan type.
 - Select **All Channels** for an initial scan or after moving the TV to an new area with a different channel line-up.
 - Select **Add only new channels** to search for channels newly broadcasting since the previous scan.
3. Press **▶** to highlight **SCAN**.
4. Press **ENTER** to start channel memorization.

Scan

See below for additional notes on Scan.

Edit

After channel scan, **Edit** lets you add and delete memorized channels. Memorized channels are those you can tune using the **CH** key. Edit the channel list to limit tuning to channels you watch.

- Press **CH/PAGE** to jump to the next or previous page of channel numbers.
- Press **▲▼◀▶** to move through all channel numbers, one at a time.

Adding/Deleting Channels Using the Channel Edit Menu

- Channels marked with a check are in memory.
- To add or delete a channel from memory, highlight the channel number and press **ENTER**.
- To add a single digital channel not in the list, see the notes under **Scan** on this page.
- Digital channels are listed by virtual channel number with the physical channel number shown in small gray text.
- **Virtual Channel Number** (digital channels only). A channel number sent by a local broadcaster.
- **Physical Digital Channel Number**. The channel number officially assigned to the actual broadcast frequency; shown on screen in gray text.

Notes on Scan and Channel Memorization

- Channel memorization may take up to 15 minutes to complete.
- To stop channel memorization before completion, press **CANCEL**. Channels already added are retained.
- When watching TV, press **CH** to move through memorized channels. Press and hold **CH** to speed through channels.
- To add a digital channel that does not appear in the **Edit** menu without performing channel memorization:
 1. Look up the physical channel number for the new digital channel. See the website www.antennaweb.org for help.
 2. Press **INPUT** and select the **ANT** input.
 3. Use the number and **CANCEL** keys to enter the physical channel number followed by “-1” and **ENTER**. For example, for physical channel 36,

 The TV will search for a digital channel on the channel 36 frequency. When it finds the channel, it will:
 - a. Add the channel to memory.
 - b. Change the channel number to the virtual channel number sent by the broadcaster.
 - c. Add to memory any associated sub-channels.
- Rememorize channels if you move the TV to a different geographic area with a different channel line-up.



Setup, continued

Setup

Energy



Lamp Energy

Standard, Bright

Standard is for most viewing conditions. Use **Bright** in brightly lit rooms. You may notice increased fan noise when using the **Bright** setting.

Setup

Network



Use of this menu is explained in the Basic Owner's Guide supplied with the television.

Ethernet Connection

DHCP (automatic), Manual

[Connection Data]

This option is available only when an Ethernet cable is connected to the TV's LAN jack.

Wireless Connection

[Network ID]

[Connection Data]

Off. Turns off the TV's wireless system radio receiver. Use this option if there is RF interference with other devices.

This option is available only when optional wireless adapter AzureWave AW-NU231 is plugged into the TV's USB jack.

840 Series. The wireless adapter must be used with the left USB jack and not the **USB-P** jack.

 **Inputs**
Inputs **Name**

INPUT and HDMI jacks:

Cable box, Cam(corder), CD, DVD (DVD, DVD2, Blu-ray), DVR, Game (Game, PS, Xbox, Wii), Media Box, PC, Satellite, AVR, On/Off (ANT only)

INPUT jacks only:

CD/Audio, MP3 Player, VCR

HDMI jacks only:

PC, AVR, Delete

- Lets you assign or change the names of inputs appearing in the **Input Selection** menu. Highlight an input and press **ENTER** multiple times to cycle through the name choices.
- Lets you turn the **Ant** input **On/Off** to display or hide it in the **Input Selection** menu; highlight the input and press **ENTER** to switch between **On** and **Off**.
- **840 Series.** Lets you turn the **Bluetooth** input **On/Off** to display or hide it in the **Input Selection** menu; highlight the input and press **ENTER** to switch between **On** and **Off**.
- Lets you delete unused HDMI inputs from the **Input Selection** menu.
- A CEC-enabled tuner can be named either **Cable Box** or **Satellite**.
- A CEC-enabled DVD player can be named **DVD, DVD2,** or **Blu-ray**.

General Notes for the Inputs > Name Menu

When you change an input name and then exit the **Name** menu:

- The name is changed
- The icon in the **Input Selection** menu is changed
- Audio and video settings are changed to the defaults for the new device type.

Notes for HDMI devices

- **Disconnecting an HDMI device:** When you disconnect an HDMI device, the icon remains in the **Input Selection** menu until you remove it. Select **Delete** in the **Inputs > Name** menu to remove an unwanted icon for an HDMI input.
- **HDMI Control and CEC-Enabled Devices:** See “HDMI Control of CEC Devices” on page 33.

- **In case of CEC conflicts:** Turn off CEC signals in one of these ways:
 - Turn off the TV’s HDMI Control signals to the device (**Inputs > HDMI Control** menu).
 - Turn off each device’s internal CEC capability.
 See “HDMI Control of CEC Devices” on page 33 for the TV’s HDMI Control or, to turn on/off a specific device’s response to CEC signals, see the device owner’s manual.
- If the **New Device Found** screen does not display as expected when you connect an HDMI device:
 - a. Power off the device.
 - b. Disconnect the HDMI cable.
 - c. Press **MENU** on the TV remote control to enter the TV main menu.
 - d. Go to **Inputs > Name**.
 - e. Highlight the HDMI input name and press **ENTER** to select **Delete**.
 - f. Press **EXIT** to clear the menus.
 - g. Connect the new device and the **New Device Found** screen will display.

Inputs, continued

Inputs **HDMI Control**



On, Off

Select **On** or **Off** to enable or disable the TV's control of a CEC-enabled device. See "Enabling HDMI Control of CEC Devices" on page 33 for use of this feature.

Note: When **HDMI Control** is set to **Off** the TV may still respond to CEC commands sent by another device. To prevent this, turn off HDMI Control in the device using the device's own menus.

Inputs **Order**



Lets you rearrange icons in the **Input Selection** menu.

1. Press ▲▼◀▶ to highlight an input icon.
2. Press ENTER to confirm the selection.
3. Press ▲▼◀▶ to drag the icon to the desired position.
4. Press ENTER to confirm the new position.

Inputs **StreamTV (740 and 840 Series)**



Internet Services Deactivation Highlight **the service name** and press **ENTER** to purge your account information stored in the TV.

Inputs **Demo**



See demonstrations showcasing selected TV features.

Inputs **Update**







Provides instructions for updating TV software.



Lock

TV Locks

	Parental <i>Lock by Program Ratings</i> Restricts access using U.S.-based ratings sent by broadcasters (740 and 840 series, U.S. only).
	Time <i>Lock by Time</i> Restricts TV use by time of day.
	Channel <i>Lock by Channel</i> Blocks access to the channels you specify.
	Panel <i>Lock Control Panel</i> Disables the buttons on the TV's control panel. Use this feature if small children in the home try to press buttons on the control panel.
	Other <i>Lock by Other Program Ratings</i> Restricts access using possible future ratings that may be sent by broadcasters (740 and 840 series, U.S. only).

Pass Code

Setting a Pass Code

You are prompted to enter a pass code whenever you select **Lock** on the main menu. To set a pass code for the first time:

1. Press **MENU** and highlight **Lock**. A screen prompting you for a pass code will display.
2. Input a four-digit pass code using the number keys on the remote control.
 - Press **CANCEL** to delete a number and move back one space.
 - Press **MENU** or **EXIT** to close the menu without setting a pass code.
3. Enter the code a second time to confirm.

Resetting a Pass Code

See the procedure in "Bypassing TV Locks" on page 30.

Parental Menu

740 and 840 Series, U.S. Only

The TV comes from the factory with the rating locks turned off and with pre-set U.S. ratings TV-PG and movie rating PG. You must turn on blocking for U.S. ratings to activate these rating restrictions. Use the **Lock > Parental** menu to change the level of blocking with U.S. ratings.

Any time you change the channel or device, it may take up to five seconds for the rating restrictions to take effect.

Other Menu (Alternate Rating System)

740 and 840 Series, U.S. Only

This TV can recognize new rating systems that may come into effect in the future. The **Other** menu allows you to block digital programming when such systems come into effect. The **Start Time** and **Stop Time** options in the **Parental** menu apply to U.S.-based ratings only and do not affect alternate rating systems.

The first time you tune to a channel broadcasting an alternate rating system, the TV defaults to the most restrictive setting if the **Lock** menu > **Other Lock** option is set to **On**. Use this menu to change the allowed rating if you are unable to watch a program rated with an alternate system.

Important Notes on Rating Locks

- **Parental** menu rating locks apply only to channels and signals received on the **ANT** and composite **VIDEO** jacks.
- **Other** menu rating locks apply only to digital channels received on **ANT**.
- When viewing a cable box, satellite receiver, or other device connected to the component **Y Pb Pr** or **HDMI** inputs, check the device's owner's guide for parental locks.



Lock, continued

Using TV Locks

After you set the lock, you must use your pass code to:

- View a locked program
- View a locked channel
- View the locked TV
- Cancel the lock
- Open the **Lock** menus

Tips for Using the Lock Menu

When entering the **Lock** menu, you will be prompted to enter a pass code.

- To change the pass code, press **9** and **LAST** at the same time. Either enter a new pass code to open the **Lock** menu and make changes or press **EXIT** to close the menu.
- If any of the locks are turned on and you exit the menus when prompted for a new code, the old code and all lock settings will be retained.

- If all locks are turned off and you exit the menus when prompted for a new code, then the previous code will be erased.

Bypassing TV Locks

- If you try to watch a blocked program or channel or the TV is locked by time, a notice will appear prompting you for a pass code. To use the TV, input your four-digit pass code and press **ENTER**.
- To reactivate the locks after using a pass code, power the TV off and then on.
- If a program is blocked, you can still use the TV without entering a pass code. Change to a channel airing an allowed program or change to another device.
- If you forget your pass code, you can view the locked TV without entering your pass code. When prompted for the pass code, press the number **9** and **LAST** keys on the TV remote control at the same time. This process temporarily unlocks the TV.

IMPORTANT

When changing or deleting your pass code, you must use the remote control included with this TV. You cannot use a Mitsubishi remote control from another component or a “universal” remote.



Lock, continued

Lock Parental



740 and 840 Series, U.S. Only

Lock Disables or enables blocking based on V-Chip signals and the U.S. rating system.

TV Rating Highlight the rating level you wish to change and press **ENTER** to block it (🔒) or allow it (🔓).
You can apply supplemental content blocking to the age-based ratings by using the TV content categories. (**FV, D, L, S, V**)

Lock	TV Rating	FV	D	L	S	V	Movie Rating	Start Time
✓ Off	🔓 TV-Y						🔓 G	12:00 PM
On	🔓 TV-Y7	🔓					🔓 PG	Stop Time
	🔓 TV-G						🔓 PG-13	12:00 PM
	🔓 TV-PG		🔓	🔓	🔓	🔓	🔓 R	
	🔓 TV-14		🔓	🔓	🔓	🔓	🔓 NC-17	
	🔓 TV-MA		🔓	🔓	🔓	🔓	🔓 X	
							🔓 Not rated	

Movie Rating Highlight the rating level you wish to change and press **ENTER** to block it (🔒) or allow it (🔓).

Start Time/Stop Time Sets the time of day for enforcement of rating restrictions chosen in the **Parental** menu. The TV clock must be set in the **Setup > Clock** menu before you can use **Start Time/Stop Time**. To make rating restrictions active 24 hours a day, set **Start Time** and **Stop Time** the same.

1. Highlight the start time or stop time.
2. Press **ENTER** to start editing.
3. Press **▲▼** to make changes.
4. Press **ENTER** to confirm changes.

TV Program Ratings

TV Age-Based Ratings	
TV-Y	Youth. For children under 7.
TV-Y7	Youth 7 and older.
TV-G	General Audience. For the entire family.
TV-PG	Parental Guidance. Parental Guidance recommended; may not be suitable for some children.
TV-14	Adolescent 14 and older. Not recommended for children under 14.
TV-MA	Mature Audience. For adults only.
TV Content Categories	
FV	Fantasy Violence. Applies to TV-Y7 only.
D	Sexual Dialog. Applies in differing degrees to TV-PG and TV-14.
L	Adult Language. Applies in differing degrees to TV-PG, TV-14, and TV-MA.
S	Sexual Situations. Applies in differing degrees to TV-PG, TV-14, and TV-MA.
V	Violence (graphic or realistic). Applies in differing degrees to TV-PG, TV-14, and TV-MA.

Movie Ratings

G	General Audience. Designed for the entire family.
PG	Parental Guidance. Parental Guidance recommended; may not be suitable for some children.
PG-13	Parental Guidance, 13 and Older. Not recommended for children under 13.
R	Restricted. Restricted in theaters to 17 years old and older unless accompanied by an adult.
NC-17	No Children 17 or Under. Restricted in theaters to 18 years old and older.
X	Adult. Designed for and restricted in theaters to adult audiences only.
Not Rated	No MPAA rating assigned



Lock, continued

Lock Time



Blocks all use of the TV during the time period you specify. You must enter a pass code to use the TV when the time lock is in effect. After releasing the lock with the pass code, the lock does not go back into effect until the next time the TV is powered on.

Lock by Time Enables/disables **Lock by Time**.

Lock Time, Unlock Time To set the lock and unlock times:

1. Highlight the lock or unlock time.
2. Press **ENTER** to start editing.
3. Press **▲▼** to make changes.
4. Press **ENTER** to confirm changes.

Note: To make Lock by Time active 24 hours a day, set **Start Time** and **Stop Time** the same.

Lock Channel



The **Channel Lock** menu lists channels currently in memory (see page 25). Highlight a channel and press **ENTER** to lock (🔒) or allow (🔓) the channel. Channels locks will be cleared the next time you perform a channel scan.

Lock Panel



Off, On **On** locks and **Off** unlocks the buttons on the TV's control panel. Use this option if small children try to press TV buttons.

- To release the Panel Lock from the TV's control panel, press and hold the **INPUT** button for ten seconds. If the TV is powered off, press **POWER** after the lock releases to make the TV power on.
- To reactivate the lock, return to this menu and change the setting to **On**.

Lock Other



**Other Menu Options (alternate rating system)
740 and 840 Series, U.S. Only**

This TV can recognize new rating systems that may come into effect in the future. Such alternate rating systems will apply only to digital programming received on the **ANT** input.

Lock **On, Off** Enables/disables program blocking.

System The rating system available for the channel

Group Rating groups available in the rating system shown on the screen. Rating groups are defined by the rating system in effect.

Rating Rating restrictions available in the selected rating system and group. Highlight the rating and press **ENTER** to check (block) or uncheck (allow) rated content.

3 HDMI Control of CEC Devices

Many newer HDMI devices have a feature called Consumer Electronics Control (CEC) or HDMI Control. HDMI Control allows one device, such as the TV, to control other devices, such as an A/V receiver or disc player. Use of CEC is optional.

Each manufacturer chooses which CEC functions to support so it is difficult to predict which devices and features are compatible with Mitsubishi's HDMI Control. You may find that CEC functions for a specific device are limited.

To use HDMI Control, you must enable it in both the TV and the device.

- **In the TV.** Enable HDMI control from the **New Device Found** screen or from the **Inputs > HDMI Control** menu.
- **In the Device.** Most devices with HDMI CEC compatibility let you turn it on or off in the device menus, where it is typically listed as "HDMI Control."

Enabling HDMI Control of CEC Devices

To ensure proper detection

- Power on HDMI devices before connecting them to the TV.
 - Connect and set up HDMI devices one at a time.
1. Power on the device and allow it to complete the power-on sequence (boot up). Stop any playback.
 2. Connect the device to one of the TV's HDMI inputs.
 3. When the TV detects the connection, the **New Device Found** screen will appear.

Note: See "If the New Device Found Screen Has No HDMI Control Option" on this page if an HDMI Control option is not offered.



New Device Found screen with HDMI Control option. This screen displays only if the device's HDMI Control is enabled.

4. If prompted for a name, highlight a name for the device and press **ENTER** to add a check. The device itself may later override the name you assign.



5. Highlight **On** and press **ENTER** to add a check.

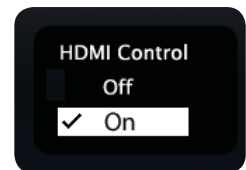

7. Highlight **EXIT** and press **ENTER** to close the **New Device Found** screen.

Note: At any time after completing Auto Input Sensing, you can set the TV's HDMI control on or off in the **Inputs > HDMI Control** menu.

If the New Device Found Screen Has No HDMI Control Option

If the **New Device Found** screen shows no option for HDMI Control, one of these conditions applies:

- **HDMI Control is turned off in the menus of the new device**
Action:
 - a. Highlight **EXIT** and press **ENTER** to close the **New Device Found** screen.
 - b. Display the device's setup menus and enable the device's CEC capabilities.
 - c. Wait for the TV's **New Device Found** screen to appear again.
 - d. If the **New Device Found** screen does not appear, power off the device. Power on the device and wait for the **New Device Found** screen to display with the HDMI Control option.
- **The HDMI cable cannot support CEC**
Action: Upgrade your HDMI cable to one that supports CEC.
- **The device does not have CEC compatibility**
Action: Control the device with its own remote control or program the TV's remote control to operate the device.

HDMI Control of an HDMI A/V Receiver and Connected Devices

1. Enable HDMI Control for the A/V receiver as described in “Enabling HDMI Control of CEC Devices” on the previous page.
2. Power on the HDMI device you wish to connect to the A/V receiver (such as a disc player, cable box, or satellite receiver). Allow the device to complete the power-on sequence (boot up). Stop playback if the device starts playing.
3. Select the device’s HDMI input on the A/V receiver’s front panel controls or remote control.
4. Connect the device to the A/V receiver with an HDMI cable.
5. When the TV detects the connection, the **New Device Found** screen will appear.

Note: If the TV is unable to detect the device, either the device’s CEC capability is not enabled or the device is not CEC compatible. Enable HDMI control through the device’s menus before continuing. You may need to temporarily connect the device directly to the TV to view device menus.

6. Highlight **On** and press **ENTER** to add a check.

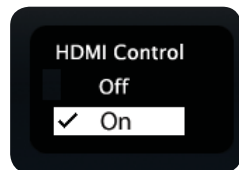

7. Highlight **EXIT** and press **ENTER** to close the **New Device Found** screen.
8. Optional: Connect the TV’s **DIGITAL AUDIO OUTPUT** to an input on the A/V receiver. Use this additional connection if:
 - You want the ability to switch between the A/V receiver speakers and the TV speakers.
 - You want to use the A/V receiver to listen to devices connected to the TV only, e.g., an antenna input or camcorder.

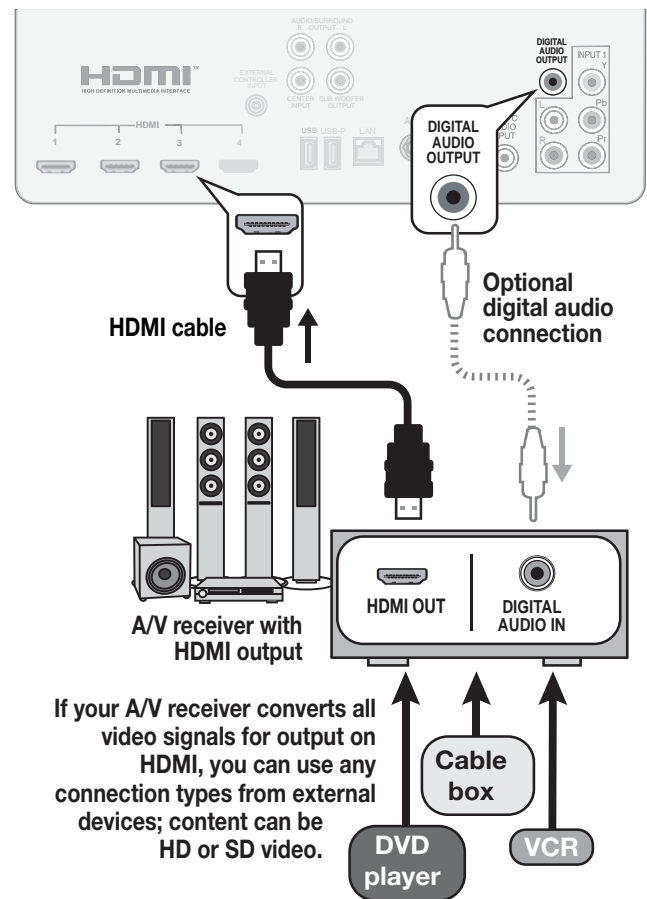

Connecting HDMI devices. The optional digital audio connection allows you to hear audio through the A/V receiver from devices connected to the TV only.

To hear audio from a device without HDMI Control, you must manually select the correct A/V receiver input for the device.

Resolving CEC Conflicts

Because each manufacturer selects which CEC functions to support, some devices may conflict with other devices. If control conflicts arise, you can:

- Turn off TV control of an individual CEC-enabled device (see below).
- Turn off CEC in the device itself. Refer to the device's Owner's Guide for instructions.

Turning Off the TV's HDMI Control of a CEC Device

1. Press **MENU** on the TV remote control.
2. Highlight **Inputs > HDMI Control**.
3. Move to the device name and press **ENTER** to select **Off** to turn off the TV's ability to control the device.
4. Press **EXIT** to clear the menu.

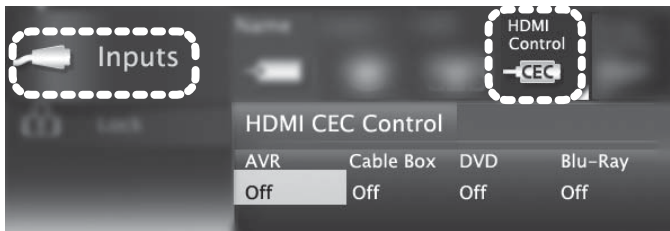

Inputs > HDMI Control menu

Removing an HDMI Device

1. Power off the device.
2. Disconnect the HDMI cable.
3. Press **MENU** on the TV remote control to enter the TV main menu.
4. Go to **Inputs > Name**.
5. Highlight the HDMI input name and press **ENTER** to select **Delete**.
6. Press **EXIT** to clear the menus.

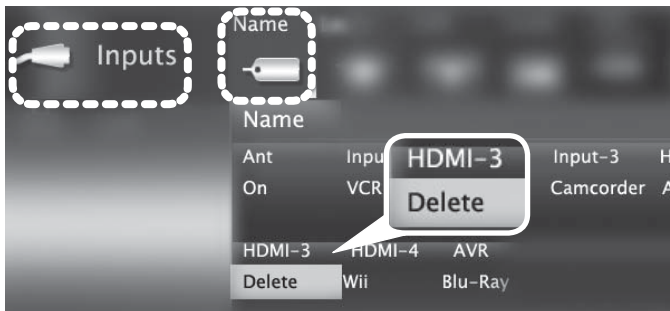

*Inputs > Name menu with **Delete** selected for HDMI-3.*

Using HDMI Control

As an example of using HDMI Control, press **PLAY** on the device itself to:

- Power on the TV
- Switch to the device (no need to display the **Input Selection** menu)
- Begin play of the device

Direct Keys

Test your equipment with the TV's remote control to find additional supported commands. See the table below for commands that may be available, depending on the individual device.

CEC-enabled VCR, DVD, and DVR functions that may be available:

Record/Playback	Menu Navigation	Channel Tuning	Other
		CH	GUIDE
	ENTER	Digits 0-9, CANCEL	TOOLS Check the TOOLS menu for supported functions.
	CANCEL (to cancel)	ENTER	

If you have a CEC-enabled A/V receiver, CEC-enabled devices connected to the A/V receiver with an HDMI cable may also be controllable. They can be selected from the TV's **Input Selection** menu.

CEC-enabled A/V receiver functions. Try the **VOL**, **MUTE**, and menu-navigation keys.

Appendix A: TV Care

Cleaning Recommendations

Normally, light dusting with a dry, non-scratching duster will keep your TV clean. If cleaning beyond this is needed, please use the following guidelines:

First, turn off the TV and unplug the power cord from the power outlet.

Occasionally clean dust build-up from the air-intake grilles on the back and sides of the TV. Clean using a vacuum cleaner with a brush attachment.

Top and Sides of the TV

- Gently wipe down your TV with a soft, non-abrasive cloth such as cotton flannel or microfiber, or a clean cloth diaper, lightly moistened with water. Dry with a second dry, soft, non-abrasive cloth.
- For oily dirt, add a few drops of mild liquid detergent, such as dishwashing detergent, to the water used to moisten the cloth. Rinse with a second cloth moistened only with water. Dry with a third dry, soft, non-abrasive cloth.

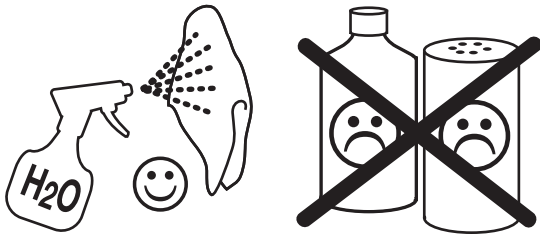

Screen

- Follow the instructions for the top and sides, wiping gently in an up and down motion.
- Clean the entire screen evenly, not just sections of the screen.
- Do not allow liquid to drip down the screen, as some liquid may enter the TV through the gap between the screen and screen frame.
- You may purchase Mitsubishi Screen Cleaner, part number CLEANER-VSS, by calling (800) 553-7278.

General Cleaning Precautions

- DO NOT allow liquid to enter the TV through the ventilation slots or any crevice.
- DO NOT use any strong or abrasive cleaners, as these can scratch the surfaces.
- DO NOT use any cleaners containing ammonia, bleach, alcohol, benzene, or thinners, as these can dull the surfaces.
- DO NOT spray liquids or cleaners directly on the TV's surfaces.
- DO NOT scrub or rub the TV harshly. Wipe it gently.

Care of the Remote Control

Remote Control Tips

- For longer life, use alkaline batteries.
- Do not mix old and new batteries.
- Be within 20 feet of the equipment.
- Do not press two or more keys at the same time unless instructed to do so.
- Do not allow the unit to get wet or become heated.
- Keep the unit out of direct sunlight.
- Avoid dropping on hard surfaces.
- Do not use harsh chemicals to clean. Use only a soft, lightly moistened cloth.

Low-Battery Indicator

If you press a key and the mode indicator blinks five times, replace the remote control's batteries.

Installing the Remote Control Batteries

1. Remove the remote control's back cover by gently pressing in the tab and lifting off the cover.
2. Load the batteries, making sure the polarities (+) and (-) are correct. For best results, insert the negative (-) end first.
3. Snap the cover back in place.

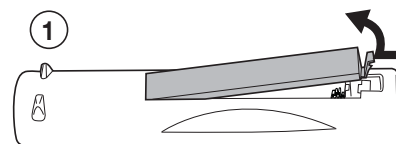

The remote control requires two AA batteries.

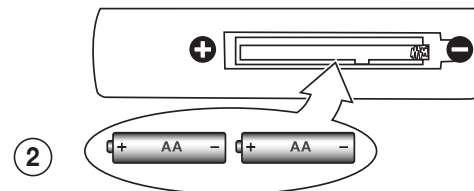

Appendix A: TV Care

Lamp-Cartridge Replacement

CAUTION: If the television is on, press **POWER** to turn it off. Unplug the television and allow it to cool for at least one hour before attempting to replace the lamp cartridge.

Lamp

The light source for this television is a lamp, which is part of a lamp cartridge assembly. The life of the lamp can vary, based on the lamp itself, the air temperature around the TV while it is operating, the selected lamp mode, and your viewing patterns. Warmer air or poor ventilation shorten the lamp life, as does setting **Lamp Energy** to **Bright** and turning the television on and off frequently.

Mitsubishi warrants the lamp for one (1) year from the date of original TV purchase at retail.

The lamp cartridge assembly is designed to be replaced by the TV owner. The cost of labor for a service technician to replace the lamp is not covered by the warranty.

Ordering a New Lamp

To Receive a Replacement Lamp Cartridge Assembly Under Warranty

- Visit our website at www.mitsuparts.com.
- Call (800) 553-7278. Please have model number, serial number, and TV purchase date available.

To Purchase a Replacement Lamp Cartridge Assembly After Warranty

Visit our website at www.mitsuparts.com or call (800) 553-7278. Order the following:

Lamp Part Number 915B455011

Lamp-Substitution Alert

MEVSA recommends that you use only genuine Replacement Lamp Assemblies purchased directly from Mitsubishi or a Mitsubishi Authorized Dealer or Mitsubishi Authorized Service Center. MEVSA advises that replacement lamps obtained separately from the Lamp Cartridge and/or Lamp Assemblies obtained from unauthorized sellers may be incorrect for your television, may not fit or perform properly and may even damage your television. MEVSA can not be responsible for the performance, reliability or safety of any replacement lamps that are obtained from unauthorized sources.

WARNING

- Do not remove the lamp cartridge immediately after turning off the television. You may get burned because the lamp is very hot. Allow the television to cool for at least one hour before replacing the lamp cartridge.
- Do not remove the lamp cartridge except when replacing it. Careless treatment can result in injury or fire.
- Do not touch the lamp glass element. It may be very hot and break, causing injuries or burns.
- Be sure not to insert any metal or flammable object into the lamp cartridge opening, as it may cause fire or electrical shock. If a foreign object is inserted into the opening, unplug the AC cord of the TV and contact your dealer for service.
- Install the lamp cartridge securely. Failure to do so may cause a fire.
- Do not touch the lamp glass elements. Oils from your fingers may cause premature lamp failure.

 = MERCURY

THE LAMP INSIDE THIS PRODUCT CONTAINS MERCURY AND MUST BE RECYCLED OR DISPOSED OF ACCORDING TO LOCAL, STATE OR FEDERAL LAWS. For disposal or recycling information, please contact your local authorities or the Electronic Industries Alliance at www.eiae.org



CAUTION



BURN DANGER! HOT SURFACES INSIDE!

Touch lamp cartridge handle only. Do not touch lamp or lamp cartridge housing. Keep lamp cartridge horizontal during removal. Do not tilt as glass may come out and cause injury. Replace lamp cartridge only with the same part number 915B455011.

WARNING

THE ACCESS PANEL IS PROVIDED WITH AN INTERLOCK TO REDUCE THE RISK OF EXCESSIVE ULTRAVIOLET RADIATION. DO NOT DEFEAT ITS PURPOSE OR ATTEMPT TO SERVICE WITHOUT REMOVING PANEL COMPLETELY.

Appendix A: TV Care

Replacement Procedure

Removing the Old Lamp Cartridge

1. Turn off TV power and unplug the TV. Allow the lamp to cool for at least one hour before proceeding.
2. After the lamp has cooled, remove the cover of the lamp compartment, located on the back of the TV. Refer to figures 1 and 2. Use a medium Phillips screwdriver to loosen the screws securing the cover.
Keep the screws and cover for re-installation
3. With a medium Phillips screwdriver, loosen the screw securing the lamp cartridge until it disengage from the mating threads. This is a captive screw and cannot be separated from the lamp cartridge.
4. Fully open the bag supplied with the replacement lamp and set the opened bag aside.
5. Gently grasp the handle of the lamp cartridge and pull the old cartridge straight out. See figure 3.

CAUTION: Do not tilt or rotate the cartridge, as small glass fragments may fall out.
6. Without tilting or putting down the lamp cartridge, insert it into the opened bag. Close the bag while being careful not to let any glass particles fall out.

Installing the New Lamp Cartridge

1. **Do not touch** the glass parts of the new lamp cartridge. Insert the new cartridge into the TV in the same orientation as the old cartridge. Push on the cartridge housing until it is fully seated.
2. Gently tighten the lamp screw with the screwdriver. **AVOID OVERTIGHTENING!**
3. Replace the plastic cover and retaining screws.
4. **WASH YOUR HANDS THOROUGHLY, AS THIS LAMP CONTAINS MERCURY.**

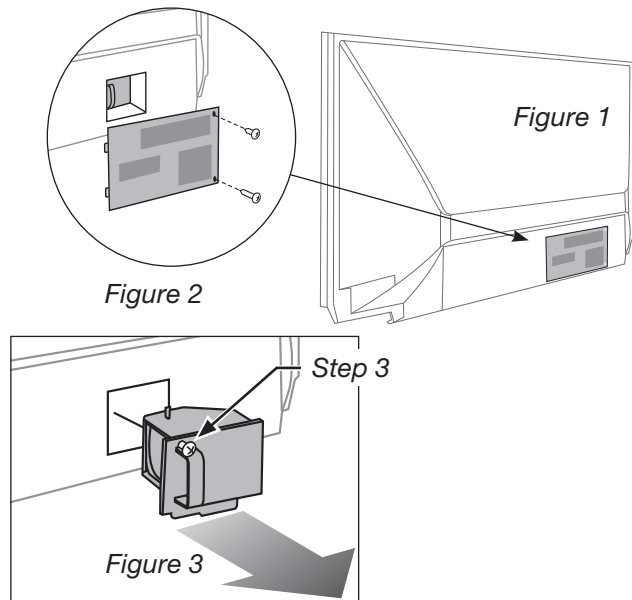

Use only replacement lamp part number 915B455011.

Disposal of the Old Lamp Cartridge

Contact your local authorities or the Electronic Industries Alliance at www.eiae.org for lamp-disposal or recycling instructions. Do not dispose of the old lamp with common trash.

Appendix B: Troubleshooting

General TV Operation		
	Symptom	Remarks
1.	The TV remote control does not work.	<ul style="list-style-type: none"> • Check that the batteries are fresh and installed correctly. • Be no more than 20 feet from the TV when using the remote control. • If using an external 3D emitter, try pointing the emitter in a different direction or disconnect the emitter. • There may be interference from the TV's internal IR emitters for 3D glasses. Turn off the emitters in the Picture > 3D Mode menu.
2.	When I try to use the remote control, the POWER key blinks five times.	Replace the batteries.
3.	TV does not respond to the remote control or to control-panel buttons and TV will not power on or off.	<ul style="list-style-type: none"> • Unplug the AC power cord for 10 seconds. • Press and hold the POWER button on the control panel for ten seconds to perform system reset.
4.	When a device is selected from the Input Selection menu, the screen is blue or black (no signal source).	<ul style="list-style-type: none"> • Make sure the selected device is turned on. • Check connections to the device. • Begin play of the device.
5.	You have forgotten your Lock menu pass code.	See "Bypassing TV Locks," page 30,
6.	Rating restrictions are not working.	Open the Lock > Parental menu and: <ul style="list-style-type: none"> • Verify that the ratings locks are active. • Check the Lock Time/Unlock Time to check if rating restrictions are disabled. • Rating restrictions apply only to content on the ANT input and composite Y/VIDEO inputs.
7.	On-screen displays appear each time you change a function.	Normal TV operation.
8.	A warning message appeared on screen stating, "TV will shut down in a few seconds. Please check if the air flow is blocked."	<ul style="list-style-type: none"> • Internal TV temperature has exceeded proper levels. Cool the room. • The TV has overheated. Clear blocked air vents and ensure at least four inches of clearance on all sides of the TV.

Service and Customer Support

Service

If you are unable to correct a problem with your TV, consult Mitsubishi Consumer Relations at 1 (800) 332-2119.

- DO NOT adjust any controls other than those described in this Owner's Guide and the on-line supplemental Owner's Guide.
- DO NOT remove the protective back cover of your TV.

Customer Support

- To order replacement or additional remote controls, visit our website at www.mitsuparts.com or call 1 (800) 553-7278.
- For questions:
 - Call Consumer Relations at 1 (800) 332-2119.
 - E-mail: TVsupport@mevsa.com
 - Website: www.mitsubishi-tv.com

For assistance call 1(800) 332-2119

Appendix B: Troubleshooting, continued

General TV Operation		
	Symptom	Remarks
9.	I have turned on CEC for my HDMI devices but control is erratic and I wish to disable it.	<ul style="list-style-type: none"> • First turn off the TV's HDMI control for the specific device. Open the Inputs > HDMI Control menu, select the device, select Off. • Disable CEC on the device itself. See the device's instructions. • If the problem persists, do the following: <ol style="list-style-type: none"> 1. Disconnect the device from the TV. 2. Open the Inputs > Name menu and select Delete for the device. 3. Reconnect the device to the TV and Auto Input Sensing will recognize the device with CEC disabled.

TV Channels		
	Symptom	Remarks
1.	The TV takes several seconds to respond to channel changes.	<ul style="list-style-type: none"> • It is normal for digital channels to take longer to tune in. • Press ENTER after entering a channel number to minimize delays. • Use a 4-digit number for an over-the-air digital channel. • Use a 6-digit number for digital cable channels if your cable service is able to recognize 6-digit channel numbers.
2.	You cannot access a channel.	<ul style="list-style-type: none"> • Use number keys instead of CH. • Be sure the channel you want to view is in memory. • Check that the TV is switched to the correct device or antenna for that channel by pressing the INPUT key. • Make sure the Lock > Parental menu lock is set to Off. • If you cannot tune to a virtual digital channel even though the TV has already memorized digital channels, tune to the physical channel number used by the broadcaster. The virtual channel will then be automatically added to memory. • You may be trying to tune to an analog channel that is no longer broadcasting.
3.	When ChannelView list is displayed, information appears incomplete	<ul style="list-style-type: none"> • Press INFO to update the display for the highlighted channel. • Program information is displayed only for the currently tuned channel. • Available information is sent from the broadcaster or cable provider. No other data is available. • Make sure the TV clock is set correctly.

Appendix B: Troubleshooting, continued

TV Power On/Off		
	Symptom	Remarks
1.	TV takes an excessively long time to power on.	When powered on, the TV needs time to boot up, just as a computer does.
2.	You cannot program the TV to turn on automatically (Timer function)	<ul style="list-style-type: none"> The TV may be locked. The clock may not be set.
3.	TV turned itself off and the light on the front panel started to blink.	<ul style="list-style-type: none"> Momentary power fluctuation can cause the TV to turn off to prevent damage. Wait for the green light to stop flashing and turn the TV on again. If the TV does not stay on, press the POWER button on the control panel for ten seconds to perform System Reset. If this happens frequently, obtain an AC line power conditioner/surge protector. An unusual digital signal may have been received, triggering a protection circuit. Wait for the light to stop flashing and turn TV on.
4.	TV will not power off.	Press the POWER key on the control panel for ten seconds to perform System Reset.

Picture		
	Symptom	Remarks
1.	Picture does not look like a high-definition picture.	Not all signals are high-definition signals. To receive high-definition programming from your cable or satellite provider, you must subscribe to the provider's high-definition service. Some over-the-air broadcasts are in high-definition and can be received with a high-quality antenna suited to your location.
2.	TV has sound but no picture.	<ul style="list-style-type: none"> Press MENU on the remote control. If the menu displays, then there is a problem with the incoming signal. Check that all video inputs are plugged in firmly. Press and hold the POWER button on the control panel for ten seconds to perform System Reset.
3.	Picture has become dimmer.	<ul style="list-style-type: none"> The lamp is nearing the end of its life. Order a new lamp. Adjust picture brightness and contrast to maximum levels. Change Lamp Energy from Standard to Bright.
4.	You cannot view a picture when playing a VHS tape.	Check your VCR's owner's guide for further troubleshooting.
5.	VCR or DVD player's on-screen menus jitter up and down.	Stop playback. Possible cause: Many VCRs and DVD players provide on-screen menus at only half-resolution that may appear to jitter up and down.
6.	When viewing a stopped VCR, white lines are rolling on the screen.	<ul style="list-style-type: none"> Turn off video mute for the VCR. Begin playing the tape. Change the VCR input from Line 1 to the VCR antenna input.
7.	A color program appears as a black and white image, or the colors are dim, or the screen is black.	840 Series. The PerfectColor color balance has been incorrectly set. Reset the PerfectColor balance.
8.	Picture from an HDMI input is noisy (poor quality).	Upgrade a standard (unmarked) HDMI cable to a high-speed HDMI cable.
9.	The image from a computer appears distorted when viewed on the TV.	<ul style="list-style-type: none"> Normal TV operation. The TV does not correct distortion in the picture from a computer because the correction process may cut off the edges of the image. The aspect ratio may be wrong for the image. Press FORMAT to change.

Appendix B: Troubleshooting, continued

Sound		
	Symptom	Remarks
1.	There is no sound even when the volume is turned up.	<ul style="list-style-type: none"> • Check if the MUTE key is on. • The TV's analog Listen to setting may be set to SAP (analog program from the ANT input) but no SAP is being broadcast. • Check that the Sound > Audio > TV Speakers option is set to On to hear sound from the TV speakers. Possibly the TV Speakers option is Off. • If using an A/V receiver, check that the Sound > Audio > TV Speakers option is set to Off to hear sound from the A/V receiver speakers. • Press and hold the POWER button on the control panel for 10 seconds to perform System Reset. • The language selected in the Setup > Antenna Digital Audio menu is not being broadcast for the current program.
2.	The sound does not match the screen picture.	The TV's analog Listen to setting may be set to SAP (analog program from the ANT input).
3.	The sound from my A/V receiver does not match the screen picture (I should hear the correct audio from my A/V receiver).	<ul style="list-style-type: none"> • Check that DIGITAL AUDIO OUTPUT and/or AVR AUDIO OUTPUT on TV's connection panel is connected to the A/V receiver. Without this connection, devices connected only to the TV (and not the A/V receiver) can be heard only from the TV speakers. Note that this includes the ANT input, a device (such as a camcorder) connected to the TV, and any other device sending audio to the TV only. • Make sure the A/V receiver is set to the correct input.
4.	Cannot select an audio-only device; it does not appear in the Input Selection menu.	Plug an unused video plug into the Y/VIDEO jack to activate Auto Input Sensing. Assign the name CD/Audio or MP3 to make the audio device selectable in the Input Selection menu.
5..	Sound is coming from the TV speakers instead of the A/V receiver.	<ul style="list-style-type: none"> • Connect the TV's audio output to the A/V receiver. • Change TV Speakers setting to Off.

Trademark and License Information

LICENSOR'S SUPPLIERS DO NOT MAKE OR PASS ON TO END USER OR ANY OTHER THIRD PARTY, ANY EXPRESS, IMPLIED OR STATUTORY WARRANTY OR REPRESENTATION ON BEHALF OF SUCH SUPPLIERS, INCLUDING, BUT NOT LIMITED TO THE IMPLIED WARRANTIES OF NON-INFRINGEMENT, TITLE, MERCHANTABILITY OR FITNESS FOR A PARTICULAR PURPOSE.



Manufactured under license from Cambridge Mechatronics Ltd.
Rapidfire and the 1... logo are trademarks of Cambridge Mechatronics Ltd

Apple, iPad, iPhone, iPod touch, iTunes, are trademarks of Apple Inc., registered in the U.S. and other countries.

The *Bluetooth*[®] word mark and logos are registered trademarks owned by Bluetooth SIG, Inc. and any use of such marks by Mitsubishi Electric is under license. Other trademarks and trade names are those of their respective owners.



Manufactured under license from Real Sound Lab, SIA.
CONEQ is a trademark of Real Sound Lab, SIA.

Digital Light Processing[®] and DLP[®] are registered trademarks of Texas Instruments.

Manufactured under license from Dolby Laboratories. "Dolby," "Pro Logic," and the double-D symbol are trademarks of Dolby Laboratories.

HDMI[®], the HDMI Logo, and High-Definition Multimedia Interface are trademarks or registered trademarks of HDMI Licensing LLC in the United States and other countries.



Imaging Science Foundation Certified Calibration Controls

The software in this TV is based in part on the work of the Independent JPEG Group, copyright © 1991-1998, Thomas G. Lane, all rights reserved.

VUDU_{TM} is a trademark of VUDU, Inc.

XPAND, X3D, X4D, X6D, their respective logos and other identifying marks of XPAND and X6D Ltd. are and shall remain the trade-marks and trade names and exclusive property of X6D Ltd.

ChannelView[™], Easy Connect[™], EdgeEnhance[™], Plush 1080p[®], are trademarks of Mitsubishi Electric Visual Solutions America, Inc.

Mitsubishi TV Software

END-USER LICENSE AGREEMENT FOR EMBEDDED SOFTWARE

IMPORTANT – READ CAREFULLY: This License Agreement is a legal agreement between you (either an individual or an entity) and Mitsubishi Electric Visual Solutions America, Inc. (MEVSA) for all software pre installed and/or provided along with this television (“Software”). By utilizing this television and Software, you agree to be bound by the terms of this License Agreement.

The Software is protected by United States copyright laws and international treaty provisions, as well as other intellectual property laws and treaties. The Software is licensed, not sold.

1. **LICENSE GRANT.** MEVSA grants you a non-exclusive, non-transferable, limited right and license to use one copy of the Software only with the Mitsubishi television model that included this owner’s guide and owned by you.

2. **RIGHTS AND LIMITATIONS.**

Software Not for Resale. You may not resell or otherwise transfer for value the Software, except in conjunction with a sale of the TV that Software has been pre installed.

Prohibition on Reverse Engineering, Decompilation and Disassembly. The Software contains trade secrets or other proprietary material in its human perceivable form and to protect them, you may not reverse engineer, decompile, or disassemble, or otherwise reduce the Software to any human perceivable form, except to the extent that the foregoing restriction is expressly prohibited by applicable law.

Separation of Components. The Software is licensed as a single product. Its component parts may not be separated for use on more than one TV.

No Rental. You may not rent, lease, lend, or sublicense the Software.

Trademarks. This License Agreement does not grant you any rights to any trademarks of MEVSA.

3. **VIOLATIONS.** You understand that any use, copying or transfer of the Software, except as permitted pursuant to this License, may subject you to serious criminal and civil penalties including damages and an award to MEVSA of attorneys’ fees in connection with any violation of this License. You further understand that you may be held legally responsible for any copyright infringement or other violation of intellectual property rights that is caused, encouraged, or induced by your failure to abide by the terms of the License. This license is effective until terminated, and will terminate immediately without notice from MEVSA or judicial resolution if you fail to comply with any provision of this License.

4. **COPYRIGHT.** All title and intellectual property rights in and to the Software (including but not limited to any images, photographs, animations, video, audio, music, text, and “applets” incorporated into the Software), and any accompanying printed materials are owned by or licensed to MEVSA. All title and intellectual property rights in and to the content which may be accessed through use of the Software is the property of the respective content owner and may be protected by applicable copyright or other intellectual property laws and treaties. This License Agreement grants you no rights to use such content, except that you own the media on which the Software is recorded, but MEVSA and its licensors retain ownership of the Software itself. All rights not expressly granted are reserved by MEVSA.

5. **EXPORT RESTRICTIONS.** MEVSA is licensing the Software for use within the United States. You agree that you will not export or re-export the Software. You specifically agree not to export or re-export the Software: (i) to any country to which the U.S. has embargoed or restricted the export of goods or services, which currently include, but are not necessarily limited to Cuba, Iran, Iraq, Libya, North Korea, Sudan, and Syria, or to any national of any such country, wherever located, who intends to transmit or transport the Software back to such country; (ii) to any person or entity who you know or have reason to know will utilize the Software in the design, development, or production of nuclear, chemical, or biological weapons; or (iii) to any person or entity who has been prohibited from participating in U.S. export transactions by any federal agency of the U.S. government. You warrant and represent that neither the BXA nor any other U.S. federal agency has suspended, revoked, or denied your export privileges.

6. **DISCLAIMER OF WARRANTY. EXCEPT AS OTHERWISE PROVIDED IN THIS LICENSE OR IN THE LIMITED WARRANTY APPLICABLE TO THE TV, MEVSA MAKES NO OTHER WARRANTIES OF ANY KIND WHATSOEVER REGARDING THE SOFTWARE AND HEREBY EXPRESSLY DISCLAIMS ALL WARRANTIES OF ANY KIND WHATSOEVER, EXPRESS OR IMPLIED, WITH RESPECT TO THE SOFTWARE. ALL IMPLIED WARRANTIES, INCLUDING, WITHOUT LIMITATION, THE IMPLIED WARRANTIES OF MERCHANTABILITY AND FITNESS FOR A PARTICULAR PURPOSE ARE HEREBY EXPRESSLY DISCLAIMED BY MEVSA. IN NO EVENT SHALL MEVSA BE LIABLE TO YOU OR ANY THIRD PARTIES, IN CONTRACT, IN TORT OR OTHERWISE, FOR ANY DIRECT, INDIRECT, SPECIAL, INCIDENTAL OR CONSEQUENTIAL DAMAGES OF ANY KIND OR NATURE. BECAUSE SOME JURISDICTIONS DO NOT ALLOW THE EXCLUSION OR LIMITATION OF IMPLIED WARRANTIES, THE ABOVE LIMITATION MAY NOT APPLY TO YOU.**

7. **LIMITATION OF LIABILITY. MEVSA SHALL NOT, UNDER ANY CIRCUMSTANCES BE LIABLE TO YOU OR ANY THIRD PARTIES FOR ANY DAMAGES OF ANY NATURE, WHETHER INDIRECT, SPECIAL, INCIDENTAL, CONSEQUENTIAL OR OTHERWISE, INCLUDING, BUT NOT LIMITED TO, ANY CLAIMS FOR LOST PROFITS, LOSS OF GOOD WILL OR EXPENDITURES MADE OR COMMITTED FOR IN RELIANCE ON THE CONTINUATION OF THIS LICENSE. YOU AGREE THAT NEITHER MEVSA’S BREACH OF THIS LICENSE NOR ITS FAILURE TO REPAIR A DEFECT, ERROR OR BUG SHALL CONSTITUTE A FAILURE OF THE ESSENTIAL PURPOSE OF THIS LICENSE. BECAUSE SOME JURISDICTIONS DO NOT ALLOW THE EXCLUSION OR LIMITATION OF LIABILITY FOR CONSEQUENTIAL OR INCIDENTAL DAMAGES, THE ABOVE LIMITATIONS MAY NOT APPLY TO YOU. MEVSA’S liability to you for direct damages for any cause whatsoever and regardless of the form of the action, will be limited to the money paid by you for the TV (based on fair market value of the TV) that caused the damages.**

8. **GENERAL.** This License Agreement will be governed by the laws of the State of California.

WARNING: This product contains chemicals known to the State of California to cause cancer and/or birth defects or other reproductive harm.

For assistance call 1(800) 332-2119

GNU GENERAL PUBLIC LICENSE

Version 3, 29 June 2007

Copyright © 2007 Free Software Foundation, Inc. <<http://fsf.org/>>

Everyone is permitted to copy and distribute verbatim copies of this license document, but changing it is not allowed.

Preamble

The GNU General Public License is a free, copyleft license for software and other kinds of works.

The licenses for most software and other practical works are designed to take away your freedom to share and change the works. By contrast, the GNU General Public License is intended to guarantee your freedom to share and change all versions of a program--to make sure it remains free software for all its users. We, the Free Software Foundation, use the GNU General Public License for most of our software; it applies also to any other work released this way by its authors. You can apply it to your programs, too.

When we speak of free software, we are referring to freedom, not price. Our General Public Licenses are designed to make sure that you have the freedom to distribute copies of free software (and charge for them if you wish), that you receive source code or can get it if you want it, that you can change the software or use pieces of it in new free programs, and that you know you can do these things.

To protect your rights, we need to prevent others from denying you these rights or asking you to surrender the rights. Therefore, you have certain responsibilities if you distribute copies of the software, or if you modify it: responsibilities to respect the freedom of others.

For example, if you distribute copies of such a program, whether gratis or for a fee, you must pass on to the recipients the same freedoms that you received. You must make sure that they, too, receive or can get the source code. And you must show them these terms so they know their rights.

Developers that use the GNU GPL protect your rights with two steps: (1) assert copyright on the software, and (2) offer you this License giving you legal permission to copy, distribute and/or modify it.

For the developers' and authors' protection, the GPL clearly explains that there is no warranty for this free software. For both users' and authors' sake, the GPL requires that modified versions be marked as changed, so that their problems will not be attributed erroneously to authors of previous versions.

Some devices are designed to deny users access to install or run modified versions of the software inside them, although the manufacturer can do so. This is fundamentally incompatible with the aim of protecting users' freedom to change the software. The systematic pattern of such abuse occurs in the area of products for individuals to use, which is precisely where it is most unacceptable. Therefore, we have designed this version of the GPL to prohibit the practice for those products. If such problems arise substantially in other domains, we stand ready to extend this provision to those domains in future versions of the GPL, as needed to protect the freedom of users.

Finally, every program is threatened constantly by software patents. States should not allow patents to restrict development and use of software on general-purpose computers, but in those that do, we wish to avoid the special danger that patents applied to a free program could make it effectively proprietary. To prevent this, the GPL assures that patents cannot be used to render the program non-free.

The precise terms and conditions for copying, distribution and modification follow.

TERMS AND CONDITIONS

0. Definitions.

"This License" refers to version 3 of the GNU General Public License.

"Copyright" also means copyright-like laws that apply to other kinds of works, such as semiconductor masks.

"The Program" refers to any copyrightable work licensed under this License. Each licensee is addressed as "you". "Licensees" and "recipients" may be individuals or organizations.

To "modify" a work means to copy from or adapt all or part of the work in a fashion requiring copyright permission, other than the making of an exact copy. The resulting work is called a "modified version" of the earlier work or a work "based on" the earlier work.

A "covered work" means either the unmodified Program or a work based on the Program.

To "propagate" a work means to do anything with it that, without permission, would make you directly or secondarily liable for infringement under applicable copyright law, except executing it on a computer or modifying a private copy. Propagation includes copying, distribution (with or without modification), making available to the public, and in some countries other activities as well.

To "convey" a work means any kind of propagation that enables other parties to make or receive copies. Mere interaction with a user through a computer network, with no transfer of a copy, is not conveying.

An interactive user interface displays "Appropriate Legal Notices" to the extent that it includes a convenient and prominently visible feature that (1) displays an appropriate copyright notice, and (2) tells the user that there is no warranty for the work (except to the extent that warranties are provided), that licensees may convey the work under this License, and how to view a copy of this License. If the interface presents a list of user commands or options, such as a menu, a prominent item in the list meets this criterion.

1. Source Code.

The "source code" for a work means the preferred form of the work for making modifications to it. "Object code" means any non-source form of a work.

A "Standard Interface" means an interface that either is an official standard defined by a recognized standards body, or, in the case of interfaces specified for a particular programming language, one that is widely used among developers working in that language.

The "System Libraries" of an executable work include anything, other than the work as a whole, that (a) is included in the normal form of packaging a Major Component, but which is not part of that Major Component, and (b) serves only to enable use of the work with that Major Component, or to implement a Standard Interface for which an implementation is available to the public in source code form. A "Major Component", in this context, means a major essential component (kernel, window system, and so on) of the specific operating system (if any) on which the executable work runs, or a compiler used to produce the work, or an object code interpreter used to run it.

The "Corresponding Source" for a work in object code form means all the source code needed to generate, install, and (for an executable work) run the object code and to modify the work, including scripts to control those activities. However, it does not include the work's System Libraries, or general-purpose tools or generally available free programs which are used unmodified in performing those activities but which are not part of the work. For example, Corresponding Source includes interface definition files associated with source files for the work, and the source code for shared libraries and dynamically linked subprograms that the work is specifically designed to require, such as by intimate data communication or control flow between those subprograms and other parts of the work.

The Corresponding Source need not include anything that users can regenerate automatically from other parts of the Corresponding Source.

The Corresponding Source for a work in source code form is that same work.

2. Basic Permissions.

All rights granted under this License are granted for the term of copyright on the Program, and are irrevocable provided the stated conditions are met. This License explicitly affirms your unlimited permission to run the unmodified Program. The output from running a covered work is covered by this License only if the output, given its content, constitutes a covered work. This License acknowledges your rights of fair use or other equivalent, as provided by copyright law.

You may make, run and propagate covered works that you do not convey, without conditions so long as your license otherwise remains in force. You may convey covered works to others for the sole purpose of having them make modifications exclusively for you, or provide you with facilities for running those works, provided that you comply with the terms of this License in conveying all material for which you do not control copyright. Those thus making or running the covered works for you must do so exclusively on your behalf, under your direction and control, on terms that prohibit them from making any copies of your copyrighted material outside their relationship with you.

Conveying under any other circumstances is permitted solely under the conditions stated below. Sublicensing is not allowed; section 10 makes it unnecessary.

3. Protecting Users' Legal Rights From Anti-Circumvention Law.

No covered work shall be deemed part of an effective technological measure under any applicable law fulfilling obligations under article 11 of the WIPO copyright treaty adopted on 20 December 1996, or similar laws prohibiting or restricting circumvention of such measures.

When you convey a covered work, you waive any legal power to forbid circumvention of technological measures to the extent such circumvention is effected by exercising rights under this License with respect to the covered work, and you disclaim any intention to limit operation or modification of the work as a means of enforcing, against the work's users, your or third parties' legal rights to forbid circumvention of technological measures.

If you are interested in obtaining open source code for this product, please contact Mitsubishi at (800) 332-2119. A nominal handling and mailing charge may apply.

For assistance call 1(800) 332-2119

4. Conveying Verbatim Copies.

You may convey verbatim copies of the Program's source code as you receive it, in any medium, provided that you conspicuously and appropriately publish on each copy an appropriate copyright notice; keep intact all notices stating that this License and any non-permissive terms added in accord with section 7 apply to the code; keep intact all notices of the absence of any warranty; and give all recipients a copy of this License along with the Program.

You may charge any price or no price for each copy that you convey, and you may offer support or warranty protection for a fee.

5. Conveying Modified Source Versions.

You may convey a work based on the Program, or the modifications to produce it from the Program, in the form of source code under the terms of section 4, provided that you also meet all of these conditions:

- The work must carry prominent notices stating that you modified it, and giving a relevant date.
- The work must carry prominent notices stating that it is released under this License and any conditions added under section 7. This requirement modifies the requirement in section 4 to "keep intact all notices".
- You must license the entire work, as a whole, under this License to anyone who comes into possession of a copy. This License will therefore apply, along with any applicable section 7 additional terms, to the whole of the work, and all its parts, regardless of how they are packaged. This License gives no permission to license the work in any other way, but it does not invalidate such permission if you have separately received it.
- If the work has interactive user interfaces, each must display Appropriate Legal Notices; however, if the Program has interactive interfaces that do not display Appropriate Legal Notices, your work need not make them do so.

A compilation of a covered work with other separate and independent works, which are not by their nature extensions of the covered work, and which are not combined with it such as to form a larger program, in or on a volume of a storage or distribution medium, is called an "aggregate" if the compilation and its resulting copyright are not used to limit the access or legal rights of the compilation's users beyond what the individual works permit. Inclusion of a covered work in an aggregate does not cause this License to apply to the other parts of the aggregate.

6. Conveying Non-Source Forms.

You may convey a covered work in object code form under the terms of sections 4 and 5, provided that you also convey the machine-readable Corresponding Source under the terms of this License, in one of these ways:

- Convey the object code in, or embodied in, a physical product (including a physical distribution medium), accompanied by the Corresponding Source fixed on a durable physical medium customarily used for software interchange.
- Convey the object code in, or embodied in, a physical product (including a physical distribution medium), accompanied by a written offer, valid for at least three years and valid for as long as you offer spare parts or customer support for that product model, to give anyone who possesses the object code either (1) a copy of the Corresponding Source for all the software in the product that is covered by this License, on a durable physical medium customarily used for software interchange, for a price no more than your reasonable cost of physically performing this conveying of source, or (2) access to copy the Corresponding Source from a network server at no charge.
- Convey individual copies of the object code with a copy of the written offer to provide the Corresponding Source. This alternative is allowed only occasionally and noncommercially, and only if you received the object code with such an offer, in accord with subsection 6b.
- Convey the object code by offering access from a designated place (gratis or for a charge), and offer equivalent access to the Corresponding Source in the same way through the same place at no further charge. You need not require recipients to copy the Corresponding Source along with the object code. If the place to copy the object code is a network server, the Corresponding Source may be on a different server (operated by you or a third party) that supports equivalent copying facilities, provided you maintain clear directions next to the object code saying where to find the Corresponding Source. Regardless of what server hosts the Corresponding Source, you remain obligated to ensure that it is available for as long as needed to satisfy these requirements.
- Convey the object code using peer-to-peer transmission, provided you inform other peers where the object code and Corresponding Source of the work are being offered to the general public at no charge under subsection 6d.

A separable portion of the object code, whose source code is excluded from the Corresponding Source as a System Library, need not be included in conveying the object code work.

A "User Product" is either (1) a "consumer product", which means any tangible personal property which is normally used for personal, family, or household purposes, or (2) anything designed or sold for incorporation into a dwelling. In determining whether a product is a consumer product, doubtful cases shall be resolved in favor of coverage. For a particular product received by a particular user, "normally used" refers to a typical or common use of that class of product, regardless of the status of the particular user or of the way in which the particular user actually uses, or expects or is expected to use, the product. A product is a consumer product regardless of whether the product has substantial commercial, industrial or non-consumer uses, unless such uses represent the only significant mode of use of the product.

"Installation Information" for a User Product means any methods, procedures, authorization keys, or other information required to install and execute modified versions of a covered work in that User Product from a modified version of its Corresponding Source. The information must suffice to ensure that the continued functioning of the modified object code is in no case prevented or interfered with solely because modification has been made.

If you convey an object code work under this section in, or with, or specifically for use in, a User Product, and the conveying occurs as part of a transaction in which the right of possession and use of the User Product is transferred to the recipient in perpetuity or for a fixed term (regardless of how the transaction is characterized), the Corresponding Source conveyed under this section must be accompanied by the Installation Information. But this requirement does not apply if neither you nor any third party retains the ability to install modified object code on the User Product (for example, the work has been installed in ROM).

The requirement to provide Installation Information does not include a requirement to continue to provide support service, warranty, or updates for a work that has been modified or installed by the recipient, or for the User Product in which it has been modified or installed. Access to a network may be denied when the modification itself materially and adversely affects the operation of the network or violates the rules and protocols for communication across the network.

Corresponding Source conveyed, and Installation Information provided, in accord with this section must be in a format that is publicly documented (and with an implementation available to the public in source code form), and must require no special password or key for unpacking, reading or copying.

7. Additional Terms.

"Additional permissions" are terms that supplement the terms of this License by making exceptions from one or more of its conditions. Additional permissions that are applicable to the entire Program shall be treated as though they were included in this License, to the extent that they are valid under applicable law. If additional permissions apply only to part of the Program, that part may be used separately under those permissions, but the entire Program remains governed by this License without regard to the additional permissions.

When you convey a copy of a covered work, you may at your option remove any additional permissions from that copy, or from any part of it. (Additional permissions may be written to require their own removal in certain cases when you modify the work.) You may place additional permissions on material, added by you to a covered work, for which you have or can give appropriate copyright permission.

Notwithstanding any other provision of this License, for material you add to a covered work, you may (if authorized by the copyright holders of that material) supplement the terms of this License with terms:

- Disclaiming warranty or limiting liability differently from the terms of sections 15 and 16 of this License; or
- Requiring preservation of specified reasonable legal notices or author attributions in that material or in the Appropriate Legal Notices displayed by works containing it; or
- Prohibiting misrepresentation of the origin of that material, or requiring that modified versions of such material be marked in reasonable ways as different from the original version; or
- Limiting the use for publicity purposes of names of licensors or authors of the material; or
- Declining to grant rights under trademark law for use of some trade names, trademarks, or service marks; or
- Requiring indemnification of licensors and authors of that material by anyone who conveys the material (or modified versions of it) with contractual assumptions of liability to the recipient, for any liability that these contractual assumptions directly impose on those licensors and authors.

All other non-permissive additional terms are considered "further restrictions" within the meaning of section 10. If the Program as you received it, or any part of it, contains a notice stating that it is governed by this License along with a term that is a further restriction, you may remove that term. If a license document contains a further restriction but permits relicensing or conveying under this License, you may add to a covered work material governed by the terms of that license document, provided that the further restriction does not survive such relicensing or conveying.

If you add terms to a covered work in accord with this section, you must place, in the relevant source files, a statement of the additional terms that apply to those files, or a notice indicating where to find the applicable terms.

Additional terms, permissive or non-permissive, may be stated in the form of a separately written license, or stated as exceptions; the above requirements apply either way.

8. Termination.

You may not propagate or modify a covered work except as expressly provided under this License. Any attempt otherwise to propagate or modify it is void, and will automatically terminate your rights under this License (including any patent licenses granted under the third paragraph of section 11).

For assistance call 1(800) 332-2119

However, if you cease all violation of this License, then your license from a particular copyright holder is reinstated (a) provisionally, unless and until the copyright holder explicitly and finally terminates your license, and (b) permanently, if the copyright holder fails to notify you of the violation by some reasonable means prior to 60 days after the cessation.

Moreover, your license from a particular copyright holder is reinstated permanently if the copyright holder notifies you of the violation by some reasonable means, this is the first time you have received notice of violation of this License (for any work) from that copyright holder, and you cure the violation prior to 30 days after your receipt of the notice.

Termination of your rights under this section does not terminate the licenses of parties who have received copies or rights from you under this License. If your rights have been terminated and not permanently reinstated, you do not qualify to receive new licenses for the same material under section 10.

9. Acceptance Not Required for Having Copies.

You are not required to accept this License in order to receive or run a copy of the Program. Ancillary propagation of a covered work occurring solely as a consequence of using peer-to-peer transmission to receive a copy likewise does not require acceptance. However, nothing other than this License grants you permission to propagate or modify any covered work. These actions infringe copyright if you do not accept this License. Therefore, by modifying or propagating a covered work, you indicate your acceptance of this License to do so.

10. Automatic Licensing of Downstream Recipients.

Each time you convey a covered work, the recipient automatically receives a license from the original licensors, to run, modify and propagate that work, subject to this License. You are not responsible for enforcing compliance by third parties with this License.

An "entity transaction" is a transaction transferring control of an organization, or substantially all assets of one, or subdividing an organization, or merging organizations. If propagation of a covered work results from an entity transaction, each party to that transaction who receives a copy of the work also receives whatever licenses to the work the party's predecessor in interest had or could give under the previous paragraph, plus a right to possession of the Corresponding Source of the work from the predecessor in interest, if the predecessor has it or can get it with reasonable efforts.

You may not impose any further restrictions on the exercise of the rights granted or affirmed under this License. For example, you may not impose a license fee, royalty, or other charge for exercise of rights granted under this License, and you may not initiate litigation (including a cross-claim or counterclaim in a lawsuit) alleging that any patent claim is infringed by making, using, selling, offering for sale, or importing the Program or any portion of it.

11. Patents.

A "contributor" is a copyright holder who authorizes use under this License of the Program or a work on which the Program is based. The work thus licensed is called the contributor's "contributor version".

A contributor's "essential patent claims" are all patent claims owned or controlled by the contributor, whether already acquired or hereafter acquired, that would be infringed by some manner, permitted by this License, of making, using, or selling its contributor version, but do not include claims that would be infringed only as a consequence of further modification of the contributor version. For purposes of this definition, "control" includes the right to grant patent sublicenses in a manner consistent with the requirements of this License.

Each contributor grants you a non-exclusive, worldwide, royalty-free patent license under the contributor's essential patent claims, to make, use, sell, offer for sale, import and otherwise run, modify and propagate the contents of its contributor version.

In the following three paragraphs, a "patent license" is any express agreement or commitment, however denominated, not to enforce a patent (such as an express permission to practice a patent or covenant not to sue for patent infringement). To "grant" such a patent license to a party means to make such an agreement or commitment not to enforce a patent against the party.

If you convey a covered work, knowingly relying on a patent license, and the Corresponding Source of the work is not available for anyone to copy, free of charge and under the terms of this License, through a publicly available network server or other readily accessible means, then you must either (1) cause the Corresponding Source to be so available, or (2) arrange to deprive yourself of the benefit of the patent license for this particular work, or (3) arrange, in a manner consistent with the requirements of this License, to extend the patent license to downstream recipients. "Knowingly relying" means you have actual knowledge that, but for the patent license, your conveying the covered work in a country, or your recipient's use of the covered work in a country, would infringe one or more identifiable patents in that country that you have reason to believe are valid.

If, pursuant to or in connection with a single transaction or arrangement, you convey, or propagate by procuring conveyance of, a covered work, and grant a patent license to some of the parties receiving the covered work authorizing them to use, propagate, modify or convey a specific copy of the covered work, then the patent license you grant is automatically extended to all recipients of the covered work and works based on it.

A patent license is "discriminatory" if it does not include within the scope of its coverage, prohibits the exercise of, or is conditioned on the non-exercise of one or more of the rights that are specifically granted under this License. You may not convey a covered work if you are a party to an arrangement with a third party that is in the business of distributing software, under which you make payment to the third party based on the extent of your activity of conveying the work, and under which the third party grants, to any of the parties who would receive the covered work from you, a discriminatory patent license (a) in connection with copies of the covered work conveyed by you (or copies made from those copies), or (b) primarily for and in connection with specific products or compilations that contain the covered work, unless you entered into that arrangement, or that patent license was granted, prior to 28 March 2007.

Nothing in this License shall be construed as excluding or limiting any implied license or other defenses to infringement that may otherwise be available to you under applicable patent law.

12. No Surrender of Others' Freedom.

If conditions are imposed on you (whether by court order, agreement or otherwise) that contradict the conditions of this License, they do not excuse you from the conditions of this License. If you cannot convey a covered work so as to satisfy simultaneously your obligations under this License and any other pertinent obligations, then as a consequence you may not convey it at all. For example, if you agree to terms that obligate you to collect a royalty for further conveying from those to whom you convey the Program, the only way you could satisfy both those terms and this License would be to refrain entirely from conveying the Program.

13. Use with the GNU Affero General Public License.

Notwithstanding any other provision of this License, you have permission to link or combine any covered work with a work licensed under version 3 of the GNU Affero General Public License into a single combined work, and to convey the resulting work. The terms of this License will continue to apply to the part which is the covered work, but the special requirements of the GNU Affero General Public License, section 13, concerning interaction through a network will apply to the combination as such.

14. Revised Versions of this License.

The Free Software Foundation may publish revised and/or new versions of the GNU General Public License from time to time. Such new versions will be similar in spirit to the present version, but may differ in detail to address new problems or concerns.

Each version is given a distinguishing version number. If the Program specifies that a certain numbered version of the GNU General Public License "or any later version" applies to it, you have the option of following the terms and conditions either of that numbered version or of any later version published by the Free Software Foundation.

If the Program does not specify a version number of the GNU General Public License, you may choose any version ever published by the Free Software Foundation.

If the Program specifies that a proxy can decide which future versions of the GNU General Public License can be used, that proxy's public statement of acceptance of a version permanently authorizes you to choose that version for the Program.

Later license versions may give you additional or different permissions. However, no additional obligations are imposed on any author or copyright holder as a result of your choosing to follow a later version.

15. Disclaimer of Warranty.

THERE IS NO WARRANTY FOR THE PROGRAM, TO THE EXTENT PERMITTED BY APPLICABLE LAW. EXCEPT WHEN OTHERWISE STATED IN WRITING THE COPYRIGHT HOLDERS AND/OR OTHER PARTIES PROVIDE THE PROGRAM "AS IS" WITHOUT WARRANTY OF ANY KIND, EITHER EXPRESSED OR IMPLIED, INCLUDING, BUT NOT LIMITED TO, THE IMPLIED WARRANTIES OF MERCHANTABILITY AND FITNESS FOR A PARTICULAR PURPOSE. THE ENTIRE RISK AS TO THE QUALITY AND PERFORMANCE OF THE PROGRAM IS WITH YOU. SHOULD THE PROGRAM PROVE DEFECTIVE, YOU ASSUME THE COST OF ALL NECESSARY SERVICING, REPAIR OR CORRECTION.

16. Limitation of Liability.

IN NO EVENT UNLESS REQUIRED BY APPLICABLE LAW OR AGREED TO IN WRITING WILL ANY COPYRIGHT HOLDER, OR ANY OTHER PARTY WHO MODIFIES AND/OR CONVEYS THE PROGRAM AS PERMITTED ABOVE, BE LIABLE TO YOU FOR DAMAGES, INCLUDING ANY GENERAL, SPECIAL, INCIDENTAL OR CONSEQUENTIAL DAMAGES ARISING OUT OF THE USE OR INABILITY TO USE THE PROGRAM (INCLUDING BUT NOT LIMITED TO LOSS OF DATA OR DATA BEING RENDERED INACCURATE OR LOSSES SUSTAINED BY YOU OR THIRD PARTIES OR A FAILURE OF THE PROGRAM TO OPERATE WITH ANY OTHER PROGRAMS), EVEN IF SUCH HOLDER OR OTHER PARTY HAS BEEN ADVISED OF THE POSSIBILITY OF SUCH DAMAGES.

17. Interpretation of Sections 15 and 16.

If the disclaimer of warranty and limitation of liability provided above cannot be given local legal effect according to their terms, reviewing courts shall apply local law that most closely approximates an absolute waiver of all civil liability in connection with the Program, unless a warranty or assumption of liability accompanies a copy of the Program in return for a fee.

GNU General Public License

Version 2, June 1991

Copyright (C) 1989, 1991

Free Software Foundation, Inc.
675 Mass Ave, Cambridge, MA 02139, USA

Everyone is permitted to copy and distribute verbatim copies of this license document, but changing it is not allowed.

Preamble

The licenses for most software are designed to take away your freedom to share and change it. By contrast, the GNU General Public License is intended to guarantee your freedom to share and change free software--to make sure the software is free for all its users. This General Public License applies to most of the Free Software Foundation's software and to any other program whose authors commit to using it. (Some other Free Software Foundation software is covered by the GNU Library General Public License instead.) You can apply it to your programs, too.

When we speak of free software, we are referring to freedom, not price. Our General Public Licenses are designed to make sure that you have the freedom to distribute copies of free software (and charge for this service if you wish), that you receive source code or can get it if you want it, that you can change the software or use pieces of it in new free programs; and that you know you can do these things.

To protect your rights, we need to make restrictions that forbid anyone to deny you these rights or to ask you to surrender the rights. These restrictions translate to certain responsibilities for you if you distribute copies of the software, or if you modify it.

For example, if you distribute copies of such a program, whether gratis or for a fee, you must give the recipients all the rights that you have. You must make sure that they, too, receive or can get the source code. And you must show them these terms so they know their rights.

We protect your rights with two steps: (1) copyright the software, and (2) offer you this license which gives you legal permission to copy, distribute and/or modify the software.

Also, for each author's protection and ours, we want to make certain that everyone understands that there is no warranty for this free software. If the software is modified by someone else and passed on, we want its recipients to know that what they have is not the original, so that any problems introduced by others will not reflect on the original authors' reputations.

Finally, any free program is threatened constantly by software patents. We wish to avoid the danger that redistributors of a free program will individually obtain patent licenses, in effect making the program proprietary. To prevent this, we have made it clear that any patent must be licensed for everyone's free use or not licensed at all.

The precise terms and conditions for copying, distribution and modification follow.

GNU GENERAL PUBLIC LICENSE

TERMS AND CONDITIONS FOR COPYING, DISTRIBUTION AND MODIFICATION

0. This License applies to any program or other work which contains a notice placed by the copyright holder saying it may be distributed under the terms of this General Public License. The "Program", below, refers to any such program or work, and a "work based on the Program" means either the Program or any derivative work under copyright law: that is to say, a work containing the Program or a portion of it, either verbatim or with modifications and/or translated into another language. (Hereinafter, translation is included without limitation in the term "modification".) Each licensee is addressed as "you".

Activities other than copying, distribution and modification are not covered by this License; they are outside its scope. The act of running the Program is not restricted, and the output from the Program is covered only if its contents constitute a work based on the Program (independent of having been made by running the Program). Whether that is true depends on what the Program does.

1. You may copy and distribute verbatim copies of the Program's source code as you receive it, in any medium, provided that you conspicuously and appropriately publish on each copy an appropriate copyright notice and disclaimer of warranty; keep intact all the notices that refer to this License and to the absence of any warranty; and give any other recipients of the Program a copy of this License along with the Program.

You may charge a fee for the physical act of transferring a copy, and you may at your option offer warranty protection in exchange for a fee.

2. You may modify your copy or copies of the Program or any portion of it, thus forming a work based on the Program, and copy and distribute such modifications or work under the terms of Section 1 above, provided that you also meet all of these conditions:

- a) You must cause the modified files to carry prominent notices stating that you changed the files and the date of any change.
- b) You must cause any work that you distribute or publish, that in whole or in part contains or is derived from the Program or any part thereof, to be licensed as a whole at no charge to all third parties under the terms of this License.
- c) If the modified program normally reads commands interactively when run, you must cause it, when started running for such interactive use in the most ordinary way, to print or display an announcement including an appropriate copyright notice and a notice that there is no warranty (or else, saying that you provide a warranty) and that users may redistribute the program under these conditions, and telling the user how to view a copy of this License. (Exception: if the Program itself is interactive but does not normally print such an announcement, your work based on the Program is not required to print an announcement.)

These requirements apply to the modified work as a whole. If identifiable sections of that work are not derived from the Program, and can be reasonably considered independent and separate works in themselves, then this License, and its terms, do not apply to those sections when you distribute them as separate works. But when you distribute the same sections as part of a whole which is a work based on the Program, the distribution of the whole must be on the terms of this License, whose permissions for other licensees extend to the entire whole, and thus to each and every part regardless of who wrote it.

Thus, it is not the intent of this section to claim rights or contest your rights to work written entirely by you; rather, the intent is to exercise the right to control the distribution of derivative or collective works based on the Program.

In addition, mere aggregation of another work not based on the Program with the Program (or with a work based on the Program) on a volume of a storage or distribution medium does not bring the other work under the scope of this License.

For assistance call 1(800) 332-2119

3. You may copy and distribute the Program (or a work based on it, under Section 2) in object code or executable form under the terms of Sections 1 and 2 above provided that you also do one of the following:

- a) Accompany it with the complete corresponding machine-readable source code, which must be distributed under the terms of Sections 1 and 2 above on a medium customarily used for software interchange; or,
- b) Accompany it with a written offer, valid for at least three years, to give any third party, for a charge no more than your cost of physically performing source distribution, a complete machine-readable copy of the corresponding source code, to be distributed under the terms of Sections 1 and 2 above on a medium customarily used for software interchange; or,
- c) Accompany it with the information you received as to the offer to distribute corresponding source code. (This alternative is allowed only for noncommercial distribution and only if you received the program in object code or executable form with such an offer, in accord with Subsection b above.)

The source code for a work means the preferred form of the work for making modifications to it. For an executable work, complete source code means all the source code for all modules it contains, plus any associated interface definition files, plus the scripts used to control compilation and installation of the executable. However, as a special exception, the source code distributed need not include anything that is normally distributed (in either source or binary form) with the major components (compiler, kernel, and so on) of the operating system on which the executable runs, unless that component itself accompanies the executable.

If distribution of executable or object code is made by offering access to copy from a designated place, then offering equivalent access to copy the source code from the same place counts as distribution of the source code, even though third parties are not compelled to copy the source along with the object code.

4. You may not copy, modify, sublicense, or distribute the Program except as expressly provided under this License. Any attempt otherwise to copy, modify, sublicense or distribute the Program is void, and will automatically terminate your rights under this License. However, parties who have received copies, or rights, from you under this License will not have their licenses terminated so long as such parties remain in full compliance.

5. You are not required to accept this License, since you have not signed it. However, nothing else grants you permission to modify or distribute the Program or its derivative works. These actions are prohibited by law if you do not accept this License. Therefore, by modifying or distributing the Program (or any work based on the Program), you indicate your acceptance of this License to do so, and all its terms and conditions for copying, distributing or modifying the Program or works based on it.

6. Each time you redistribute the Program (or any work based on the Program), the recipient automatically receives a license from the original licensor to copy, distribute or modify the Program subject to these terms and conditions. You may not impose any further restrictions on the recipients' exercise of the rights granted herein. You are not responsible for enforcing compliance by third parties to this License.

7. If, as a consequence of a court judgment or allegation of patent infringement or for any other reason (not limited to patent issues), conditions are imposed on you (whether by court order, agreement or otherwise) that contradict the conditions of this License, they do not excuse you from the conditions of this License. If you cannot distribute so as to satisfy simultaneously your obligations under this License and any other pertinent obligations, then as a consequence you may not distribute the Program at all. For example, if a patent license would not permit royalty-free redistribution of the Program by all those who receive copies directly or indirectly through you, then the only way you could satisfy both it and this License would be to refrain entirely from distribution of the Program.

If any portion of this section is held invalid or unenforceable under any particular circumstance, the balance of the section is intended to apply and the section as a whole is intended to apply in other circumstances.

It is not the purpose of this section to induce you to infringe any patents or other property right claims or to contest validity of any such claims; this section has the sole purpose of protecting the integrity of the free software distribution system, which is implemented by public license practices. Many people have made generous contributions to the wide range of software distributed through that system in reliance on consistent application of that system; it is up to the author/donor to decide if he or she is willing to distribute software through any other system and a licensee cannot impose that choice.

This section is intended to make thoroughly clear what is believed to be a consequence of the rest of this License.

8. If the distribution and/or use of the Program is restricted in certain countries either by patents or by copyrighted interfaces, the original copyright holder who places the Program under this License may add an explicit geographical distribution limitation excluding those countries, so that distribution is permitted only in or among countries not thus excluded. In such case, this License incorporates the limitation as if written in the body of this License.

9. The Free Software Foundation may publish revised and/or new versions of the General Public License from time to time. Such new versions will be similar in spirit to the present version, but may differ in detail to address new problems or concerns.

Each version is given a distinguishing version number. If the Program specifies a version number of this License which applies to it and "any later version", you have the option of following the terms and conditions either of that version or of any later version published by the Free Software Foundation. If the Program does not specify a version number of this License, you may choose any version ever published by the Free Software Foundation.

10. If you wish to incorporate parts of the Program into other free programs whose distribution conditions are different, write to the author to ask for permission. For software which is copyrighted by the Free Software Foundation, write to the Free Software Foundation; we sometimes make exceptions for this. Our decision will be guided by the two goals of preserving the free status of all derivatives of our free software and of promoting the sharing and reuse of software generally.

NO WARRANTY

11. BECAUSE THE PROGRAM IS LICENSED FREE OF CHARGE, THERE IS NO WARRANTY FOR THE PROGRAM, TO THE EXTENT PERMITTED BY APPLICABLE LAW. EXCEPT WHEN OTHERWISE STATED IN WRITING THE COPYRIGHT HOLDERS AND/OR OTHER PARTIES PROVIDE THE PROGRAM "AS IS" WITHOUT WARRANTY OF ANY KIND, EITHER EXPRESSED OR IMPLIED, INCLUDING, BUT NOT LIMITED TO, THE IMPLIED WARRANTIES OF MERCHANTABILITY AND FITNESS FOR A PARTICULAR PURPOSE. THE ENTIRE RISK AS TO THE QUALITY AND PERFORMANCE OF THE PROGRAM IS WITH YOU. SHOULD THE PROGRAM PROVE DEFECTIVE, YOU ASSUME THE COST OF ALL NECESSARY SERVICING, REPAIR OR CORRECTION.

12. IN NO EVENT UNLESS REQUIRED BY APPLICABLE LAW OR AGREED TO IN WRITING WILL ANY COPYRIGHT HOLDER, OR ANY OTHER PARTY WHO MAY MODIFY AND/OR REDISTRIBUTE THE PROGRAM AS PERMITTED ABOVE, BE LIABLE TO YOU FOR DAMAGES, INCLUDING ANY GENERAL, SPECIAL, INCIDENTAL OR CONSEQUENTIAL DAMAGES ARISING OUT OF THE USE OR INABILITY TO USE THE PROGRAM (INCLUDING BUT NOT LIMITED TO LOSS OF DATA OR DATA BEING RENDERED INACCURATE OR LOSSES SUSTAINED BY YOU OR THIRD PARTIES OR A FAILURE OF THE PROGRAM TO OPERATE WITH ANY OTHER PROGRAMS), EVEN IF SUCH HOLDER OR OTHER PARTY HAS BEEN ADVISED OF THE POSSIBILITY OF SUCH DAMAGES.

Mitsubishi Home-Cinema Television Limited Warranty (U.S. Only)

MITSUBISHI ELECTRIC VISUAL SOLUTIONS AMERICA, INC. ("MEVSA") warrants as follows to the original purchaser of this television from an authorized MITSUBISHI Audio/Video Dealer, should it prove defective by reason of against defects arising from improper workmanship and/or material:

a. Parts. The lenticular (i.e. front picture) screen is warranted against defects in materials and workmanship for a period of thirty (30) days from the date of the original purchase at retail. The lamp and all other parts (except any software incorporated into this television) are warranted for a period of one (1) year from the date of the original purchase at retail. We will repair or replace, at our option, any defective part without charge for the part. Parts used for replacement may be replaced with those of like kind and quality and may be new or remanufactured. Parts used for replacement are warranted for the remainder of the original warranty period.

b. Embedded Software. MEVSA warrants that all software developed by MEVSA and incorporated into this television set (the "Embedded Software") will perform in accordance with the functional description of Embedded Software in all material respects, but MEVSA does not warrant that the Embedded Software is error-free. The limited warranty contained in this section shall continue for a period of one (1) year from the date of the original purchase at retail. If, after prompt notice within the warranty period, MEVSA determines that the Embedded Software has failed to perform in accordance with such functional description in all material respects and if such failure is not due to accident, misuse, modification or misapplication of the Embedded Software, then MEVSA shall modify the nonconforming Embedded Software and make available the modified Embedded Software at no charge to you, which at MEVSA's sole discretion may be fulfilled by means of modification or replacement software contained on a replacement memory card or made available through download via the Internet or email for Customer installation. The foregoing shall be MEVSA's sole obligation to you under this limited warranty. All rights under this limited warranty on the Embedded Software also subject to your acceptance of and compliance with the terms of the Software License Agreement applicable to this television, and this limited warranty on the Embedded Software shall be null and void if the Embedded Software is modified or changed in any manner except as specifically authorized by MEVSA.

c. Labor. For thirty (30) days after the original purchase at retail, we will repair or replace, at our option, the lenticular screen if it proves defective. For certain items that are designed to be replaced by the consumer, including (but not limited to) some Embedded Software and Lamps, the consumer is solely responsible for any replacement labor. For all other parts, we will provide the labor for a warranty repair by an authorized MITSUBISHI service center without charge for one (1) year from the original date of purchase at retail.

d. Notice. To obtain warranty service, you must notify an authorized MITSUBISHI service center of any defect within the applicable warranty time period.

e. This DLP Projection Television uses a single DLP chip to create the screen image. This technology creates the image using small dots, or picture elements (pixels). Your DLP Projection TV is manufactured to a high level of performance and quality, in fact, 99.99% perfect in the number of properly functioning pixels. As in other display technology, sometimes a pixel is continuously active, inactive or the incorrect color. Our standard is clear; MEVSA warrants only that the percentage of properly functioning pixels will be not less than 99.99% of all pixels.

BEFORE REQUESTING SERVICE, please review the instruction booklet to insure proper installation and correct customer control adjustment. If the problem persists please arrange for warranty service.

1. TO OBTAIN WARRANTY SERVICE:

a. Contact your nearest authorized MITSUBISHI service center, whose name and address can be obtained from your MITSUBISHI dealer, by writing at the address provided below, calling MEVSA at the 800-332-2119, or by using the support feature of our website at www.Mitsubishi-tv.com.

b. Warranty service will be provided in your home or, if required, at an authorized service shop, provided that your television is located within the geographic territory customarily covered by an authorized MITSUBISHI service center. If not, you must either deliver your television to an authorized service location at your own expense, or pay for any travel and/or transportation costs the service center may charge to and from your home. Actual service labor will be provided without charge.

c. Proof of purchase date from an authorized MITSUBISHI dealer is required when requesting warranty service. Present your sales receipt or other document which establishes proof and date of purchase. THE RETURN OF THE OWNER REGISTRATION CARD IS NOT A CONDITION OF COVERAGE UNDER THIS LIMITED WARRANTY. However, please return the Owner Registration Card so that we can contact you should a question of safety arise which could affect you.

d. To obtain a replacement lamp, order the lamp directly from the MEVSA Parts Department at (800) 553-7278.

For assistance call 1(800) 332-2119

2. THIS LIMITED WARRANTY DOES NOT COVER:

- a. Up to .01% pixel outages (small dot picture elements that are dark or incorrectly illuminated).
- b. Damage to the lenticular screen or Fresnel lens, screen frame, cosmetic damage or to any other damage where such damage is caused by unauthorized modification, alteration, repairs to or service of the product by anyone other than an authorized MITSUBISHI service center; physical abuse to or misuse of the product (including any failure to carry out any maintenance as described in the Owner's Guide including air vent cleaning or any product damaged by excessive physical or electrical stress); any products that have had a serial number or any part thereof altered, defaced or removed; product use in any manner contrary to the Owner's Guide; freight damage; or any damage caused by acts of God or other factors beyond the reasonable control of MEVSA, such as power surge damage caused by electrical system or lightning. This limited warranty also excludes service calls where no defect in the product covered under this warranty is found, service calls related to unsatisfactory audio or visual reception or signal unless caused by a defect in the product that is covered under this limited warranty, all costs, expenses or any other damages arising from product installation, or set-ups, any adjustments of user controls (including contrast, brightness, color, tint, fine tuning, sharpness), other adjustment necessary to prepare the unit for display or use, connection with any external audio receiver, antenna, cable or satellite systems, or service of products purchased or serviced outside the U.S.A. Please consult the operating instructions contained in the Owner's Guide furnished with the product for information regarding user controls.

3. ANY EXPRESS WARRANTY NOT PROVIDED HEREIN, AND ANY REMEDY WHICH, BUT FOR THIS PROVISION, MIGHT ARISE BY IMPLICATION OR OPERATION OF LAW, IS HEREBY EXCLUDED AND DISCLAIMED. THE IMPLIED WARRANTIES OF MERCHANTABILITY AND OF FITNESS FOR ANY PARTICULAR PURPOSE ARE EXPRESSLY LIMITED TO A TERM OF ONE YEAR.

4. UNDER NO CIRCUMSTANCES SHALL MEVSA BE LIABLE TO PURCHASER OR ANY OTHER PERSON FOR ANY INCIDENTAL, SPECIAL OR CONSEQUENTIAL DAMAGES, WHETHER ARISING OUT OF BREACH OF WARRANTY, BREACH OF CONTRACT, OR OTHERWISE.

5. Some states do not allow limitations on how long an implied warranty lasts, or the exclusion or limitation of incidental, special, or consequential damages, so the above limitations or exclusions may not apply to you.

6. This limited warranty gives you specific legal rights, and you may also have other rights which vary from state to state.

7. In the event of any dispute under this limited warranty, jurisdiction and venue for resolving that dispute will be in the state where the television was purchased and the laws of such state will govern.



MITSUBISHI ELECTRIC VISUAL SOLUTIONS AMERICA, INC.
9351 Jeronimo Road
Irvine, CA 92618-1904

Mitsubishi Home-Cinema Television Limited Warranty (Canada only)

This limited warranty is valid only for products purchased, used and serviced in Canada. MITSUBISHI ELECTRIC VISUAL SOLUTIONS AMERICA, INC. (“MEVSA”) warrants as follows to the original purchaser of this television from an authorized MITSUBISHI Audio/Video Dealer, should it prove defective by reason of against defects arising from improper workmanship and/or material:

a. Parts. The lenticular (i.e. front picture) screen is warranted against defects in materials and workmanship for a period of thirty (30) days from the date of the original purchase at retail. The lamp and all other parts (except any software incorporated into this television) are warranted for a period of one (1) year from the date of the original purchase at retail. We will repair or replace, at our option, any defective part without charge for the part. Parts used for replacement may be replaced with those of like kind and quality and may be new or remanufactured. Parts used for replacement are warranted for the remainder of the original warranty period.

b. Embedded Software. MEVSA warrants that all software developed by MEVSA and incorporated into this television set (the “Embedded Software”) will perform in accordance with the functional description of Embedded Software in all material respects, but MEVSA does not warrant that the Embedded Software is error-free. The limited warranty contained in this section shall continue for a period of one (1) year from the date of the original purchase at retail. If, after prompt notice within the warranty period, MEVSA determines that the Embedded Software has failed to perform in accordance with such functional description in all material respects and if such failure is not due to accident, misuse, modification or misapplication of the Embedded Software, then MEVSA shall modify the nonconforming Embedded Software and make available the modified Embedded Software at no charge to you, which at MEVSA’s sole discretion may be fulfilled by means of modification or replacement software contained on a replacement memory card or made available through download via the Internet or email for Customer installation. The foregoing shall be MEVSA’s sole obligation to you under this limited warranty. All rights under this limited warranty on the Embedded Software also subject to your acceptance of and compliance with the terms of the Software License Agreement applicable to this television, and this limited warranty on the Embedded Software shall be null and void if the Embedded Software is modified or changed in any manner except as specifically authorized by MEVSA.

c. Labor. For thirty (30) days after the original purchase at retail, we will repair or replace, at our option, the lenticular screen if it proves defective. For certain items that are designed to be replaced by the consumer, including (but not limited to) some Embedded Software and Lamps, the consumer is solely responsible for any replacement labor. For all other parts, we will provide the labor for a warranty repair by an authorized MITSUBISHI service center without charge for one (1) year from the original date of purchase at retail.

d. Notice. To obtain warranty service, you must notify an authorized MITSUBISHI service center of any defect within the applicable warranty time period.

e. This DLP Projection Television uses a single DLP chip to create the screen image. This technology creates the image using small dots, or picture elements (pixels). Your DLP Projection TV is manufactured to a high level of performance and quality, in fact, 99.99% perfect in the number of properly functioning pixels. As in other display technology, sometimes a pixel is continuously active, inactive or the incorrect color. Our standard is clear; MEVSA warrants only that the percentage of properly functioning pixels will be not less than 99.99% of all pixels.

BEFORE REQUESTING SERVICE, please review the instruction booklet to insure proper installation and correct customer control adjustment. If the problem persists please arrange for warranty service.

1. TO OBTAIN WARRANTY SERVICE:

a. Contact your nearest authorized MITSUBISHI service center, whose name and address can be obtained from your MITSUBISHI dealer or by calling MEVSA at 800-332-2119.

b. Warranty service will be provided in your home or, if required, at an authorized service shop, provided that your television is located within the geographic territory customarily covered by an authorized MITSUBISHI service center. If not, you must either deliver your television to an authorized service location at your own expense, or pay for any travel and/or transportation costs the service center may charge to and from your home. Actual service labor will be provided without charge.

c. Proof of purchase date from an authorized MITSUBISHI dealer is required when requesting warranty service. Present your sales receipt or other document which establishes proof and date of purchase. **THE RETURN OF THE OWNER REGISTRATION CARD IS NOT A CONDITION OF COVERAGE UNDER THIS LIMITED WARRANTY.** However, please return the Owner Registration Card so that we may contact you should a question of safety arise which could affect you.

2. THIS LIMITED WARRANTY DOES NOT COVER:

a. Up to .01% pixel outages (small dot picture elements that are dark or incorrectly illuminated).

For assistance call 1(800) 332-2119

b. Damage to the lenticular screen or Fresnel lens, screen frame, cosmetic damage or to any other damage where such damage is caused by unauthorized modification, alteration, repairs to or service of the product by anyone other than an authorized MITSUBISHI service center; physical abuse to or misuse of the product (including any failure to carry out any maintenance as described in the Owner's Guide including air vent cleaning or any product damaged by excessive physical or electrical stress); any products that have had a serial number or any part thereof altered, defaced or removed; product use in any manner contrary to the Owner's Guide; freight damage; or any damage caused by acts of God or other factors beyond the reasonable control of MEVSA, such as power surge damage caused by electrical system or lightning. This limited warranty also excludes service calls where no defect in the product covered under this warranty is found, service calls related to unsatisfactory audio or visual reception or signal unless caused by a defect in the product that is covered under this limited warranty, all costs, expenses or any other damages arising from product installation, or set-ups, any adjustments of user controls (including contrast, brightness, color, tint, fine tuning, sharpness), other adjustment necessary to prepare the unit for display or use, connection with any external audio receiver, antenna, cable or satellite systems, or service of products purchased or serviced outside Canada. Please consult the operating instructions contained in the Owner's Guide furnished with the product for information regarding user controls.

3. ANY EXPRESS WARRANTY NOT PROVIDED HEREIN, AND ANY REMEDY WHICH, BUT FOR THIS PROVISION, MIGHT ARISE BY IMPLICATION OR OPERATION OF LAW, IS HEREBY EXCLUDED AND DISCLAIMED. THE IMPLIED WARRANTIES OF MERCHANTABILITY AND OF FITNESS FOR ANY PARTICULAR PURPOSE ARE EXPRESSLY LIMITED TO A TERM OF ONE YEAR.

4. UNDER NO CIRCUMSTANCES SHALL MEVSA BE LIABLE TO PURCHASER OR ANY OTHER PERSON FOR ANY INCIDENTAL, SPECIAL OR CONSEQUENTIAL DAMAGES, WHETHER ARISING OUT OF BREACH OF WARRANTY, BREACH OF CONTRACT, OR OTHERWISE.

5. Some jurisdictions do not allow limitations on how long an implied warranty lasts, or the exclusion or limitation of incidental, special, or consequential damages, so the above limitations or exclusions may not apply to you.

6. This limited warranty gives you specific legal rights, and you may also have other rights which vary from province to province.



MITSUBISHI ELECTRIC VISUAL SOLUTIONS AMERICA, INC.
9351 Jeronimo Road
Irvine, CA 92618
www.Mitsubishi-tv.com

Mitsubishi Electric Visual Solutions America, Inc. (MEVSA) Internet Applications Policy

MEVSA Internet Applications afford the opportunity to access third party Internet product offerings or services (“Third Party Services”) on certain Mitsubishi TVs. The Third Party Services accessible herein are provided as per our agreement with these third parties. These agreements are subject to change, interruption, suspension (including termination) at any time and for various reasons. MEVSA makes no warranties or representations that any particular Third Party Service will be accessible, available, function in any particular manner or function at all.

Internet Access Required for Third Party Services; Updates:

To use these Third Party Services, you must obtain high-speed/broadband access to the Internet (such as DSL, cable or T1 lines), either directly or through devices that access the Internet and pay any service fees associated with such access. In addition, you must provide all equipment necessary to make such connection to the Internet including a modem or other Internet access device. Each individual third party Internet product may require different minimum Internet connection speed. The usability and availability of a functional Mitsubishi television and its internet connected feature may highly be dependent and varied based on high-speed/broadband internet access, connection speed, bandwidth, other equipment(s), third party applications, firmware updates and other factors outside of MEVSA’s control and/or responsibility which may also be independent of the actual operation of the television. It is further understood that Mitsubishi televisions are integrated with sophisticated technologies (software and hardware) which may exhibit delayed boot-up/shutdown time and/or interrupted services. You further understand that the Third Party Services specifications and functionality are constantly evolving and that we may directly, or indirectly via third parties, update or change the Third Party Services, in whole or in part, at any time and without notice to you. Such updates may be required for you to use certain aspects of the Third Party services or to continue to connect to the Third Party Services.

Availability of Content on Third Party Services:

MEVSA or said third parties providing Third Party Services reserve the right to delete data from their servers, or prevent access to their servers or to change data categories, product offerings or service levels for any reason that MEVSA or said third parties deem sufficient in their sole discretion at any time, without notice. MEVSA may also impose additional or different limits on the use of or access to certain Third Party Services, in any case and without notice or liability. Some or all of the data or functionality of the Third Party Services may require additional payment and/or subscription by you. However, in no event will you be charged for any Third Party Services unless those charges are made known to you in advance. MEVSA makes no warranties or representations of any kind as to the accuracy, currency, or completeness of any information contained on the data servers of such third party providers of any Third Party Services. Furthermore, we do not review, control, or endorse the content, products or services of Third Party Services or their data servers.

THIRD PARTY SERVICES ARE PROVIDED SERVICE “AS IS” AND “AS AVAILABLE,” WITHOUT WARRANTY OF ANY KIND (INCLUDING ANY IMPLIED WARRANTY OF MERCHANTABILITY, NON-INFRINGEMENT, OR FITNESS FOR A PARTICULAR PURPOSE), TO THE MAXIMUM EXTENT PERMITTED BY LAW. USE OF THE THIRD PARTY SERVICES IS AT YOUR SOLE RISK. THIS MEANS, FOR EXAMPLE, THAT MEVSA DOES NOT GUARANTEE THAT THE THIRD PARTY SERVICES WILL ALWAYS WORK PROPERLY OR WORK AT ALL. THIS ALSO MEANS WE DO NOT GUARANTEE THAT THE THIRD PARTY SERVICES, CONTENT OR PRODUCTS WILL BE FREE FROM VIRUSES, HACKS, OR OTHER POTENTIALLY HARMFUL INTRUSIONS. PLEASE NOTE THAT SOME STATES DO NOT ALLOW SUCH WARRANTY LIMITATIONS, SO THESE LIMITATIONS MAY NOT APPLY TO YOU.

Third Party Services Content Disclaimer:

Certain Third Party Services may include materials from third parties or links to certain third party data servers. You acknowledge and agree that MEVSA is not responsible for examining or evaluating the content or accuracy of any Third Party Services, their data servers or related third-party materials. MEVSA does not warrant or endorse and does not assume and will not have any liability or responsibility for any third-party materials or web sites, or for any other materials, products, or services of third parties. Links to Third Party Services and any associated links to other data servers are provided solely as a convenience to you. To the extent provided, content types or descriptions of Third Party Services provided for convenience, and you acknowledge and agree that MEVSA does not guarantee their accuracy. You understand that by using any of the Third Party Services, you may encounter content that may be deemed offensive, indecent, or objectionable, which content may or may not be identified as having explicit language. Nevertheless, you agree to use the Third Party Services at your sole risk and that MEVSA shall have no liability to you for content that may be found to be offensive, indecent, or objectionable. You agree that you will not use any third-party materials in a manner that would infringe or violate the rights of any other party, and that MEVSA is not in any way responsible for any such use by you.

Index

- A**
 Anamorphic Picture Format 7
 Antenna Input (ANT) 10
 Signal Strength for Digital Channels 8
 Audio Output Jacks 9
 Auto-Off (Sleep Timer) 5
 Auto-On (Timer) 24
 A/V Receiver Center Channel 16
- B**
 Batteries 36
 Bright (Lamp Mode) 26
 Brightness (picture adjustment) 18
- C**
 Captions Menu 23
 CD Player 12
 CEC (Consumer Electronics Control) 33
 A/V Receiver 34
 Troubleshooting 40
 Center Channel 16
 Channels
 antennaweb.org 25
 Favorites (Fav) 5
 Physical/Virtual Channel Numbers 25
 Scan (memorize) 25
 Troubleshooting 40
 ChannelView™ Channel Listings 6
 Cleaning 36
 Clock, Set Date and Time 24
 Closed Captions 23
 Color Adjustments
 Menu Controls 18
 Reset PerfectColor 19
 Computer 11, 13
 Contrast 17
 Control Panel Lock 32
- D**
 Date. *See* Clock
 DIGITAL AUDIO OUTPUT 10
 DVI Device, Connecting 11
- F**
 Fan Noise 3
 FAV (Favorite Inputs) 5
 Film Mode 18
- G**
 Game
 Game Picture Mode 17
 HDMI Cables for Games 9
- H**
 HDMI
 Connecting an HDMI Device 11
 HDMI Cable Types 9
 HDMI Jack 9
 Removing an HDMI Device from the Activity Menu 27
 Headphones 22
- I**
 INFO Key
 ChannelView 6
 Status Display 8
 INPUT Key/Input Selection Menu
 Change Input Name 27
 Removing a Disconnected HDMI Device 27
- L**
 Lamp Energy 26
 Language
 Changing the Menu Language 24
 In Digital Programs 24
 SAP (Second Audio Program) 21
 Letter Box Image Display 7
 Level Sound 21
 Listen To 21
 Listings 6
 Lock TV
 Lock by Channel 32
 Lock by Ratings 31
 Lock by Time 32
 Lock Control Panel 32
 Preset V-Chip Blocking 29
- M**
 Memorizing Channels 25
 Add Single Channel to Memory 25
 MP3 Player (audio-only connection) 12
- P**
 Pass Code
 Resetting 30
 Setting 29
 PerfectColor 19
 Picture
 Picture Menu Adjustments 17
 Picture Quality and Film Mode 18
 Shape (format) 7, 13
 Troubleshooting 41
 Power On/Off Troubleshooting 41
- R**
 Ratings (TV and Movie) 31
 Rear Speakers 15
- S**
 Safety Instructions 4
 SAP (second audio program) 21
 Scan (memorize channels) 25
 Screensaver 18
 SD (Standard-Definition Signal) 8
 Service and Support 39
 Signal Definitions 8
 Signal Strength Indicator 8
 Sleep Timer 5
 Sound
 Level Sound 21
 Menu Adjustments 21
 Sound Mode (audio effects) 21
 Standard-Definition Signal 8
 Standard Lamp Mode 26
 Stand Part Number 2
 Status Display 8
 Subwoofer 14, 21, 22
 Surround Sound
 Rear Speakers 15
 Simulated Surround Sound 21
 TV Audio Outputs 10
- T**
 3D GLASSES EMITTER Jack 10
 3D Video 20
 Time. *See* Clock
 Timer (auto-on) 24
 Time Zone. *See* Clock
 Troubleshooting 39
- U**
 USB Port 10
 Wireless Subwoofer 14
- V**
 V-Chip Ratings
 Definitions 31
 In Status Display 8
 Video from a Digital Camera 12
- W**
 Wireless Subwoofer 14



Website:

www.mitsubishi-tv.com

E-mail:

TVsupport@mevsa.com

**For questions, call Consumer Relations at
1 (800) 332-2119**

**To order replacement or additional
remote controls or lamp cartridges,**

Visit our website www.mitsuparts.com

or call

800-553-7278

Lamp-Substitution Alert

MEVSA recommends that you use only genuine Replacement Lamp Assemblies purchased directly from Mitsubishi or a Mitsubishi Authorized Dealer or Mitsubishi Authorized Service Center. MEVSA advises that replacement lamps obtained separately from the Lamp Cartridge and/or Lamp Assemblies obtained from unauthorized sellers may be incorrect for your television, may not fit or perform properly and may even damage your television. MEVSA can not be responsible for the performance, reliability or safety of any replacement lamps that are obtained from unauthorized sources.

SYSTEM RESET

If the TV does not respond to the remote control, control-panel buttons, or will not power on/off, press and hold the **POWER** button on the control panel for ten seconds.

The TV will turn off. Power on the TV and the green LED will flash quickly for about one minute. Recent settings changes may be lost.