

# HD1501

*15" Powered Subwoofer*

**OWNER'S MANUAL**

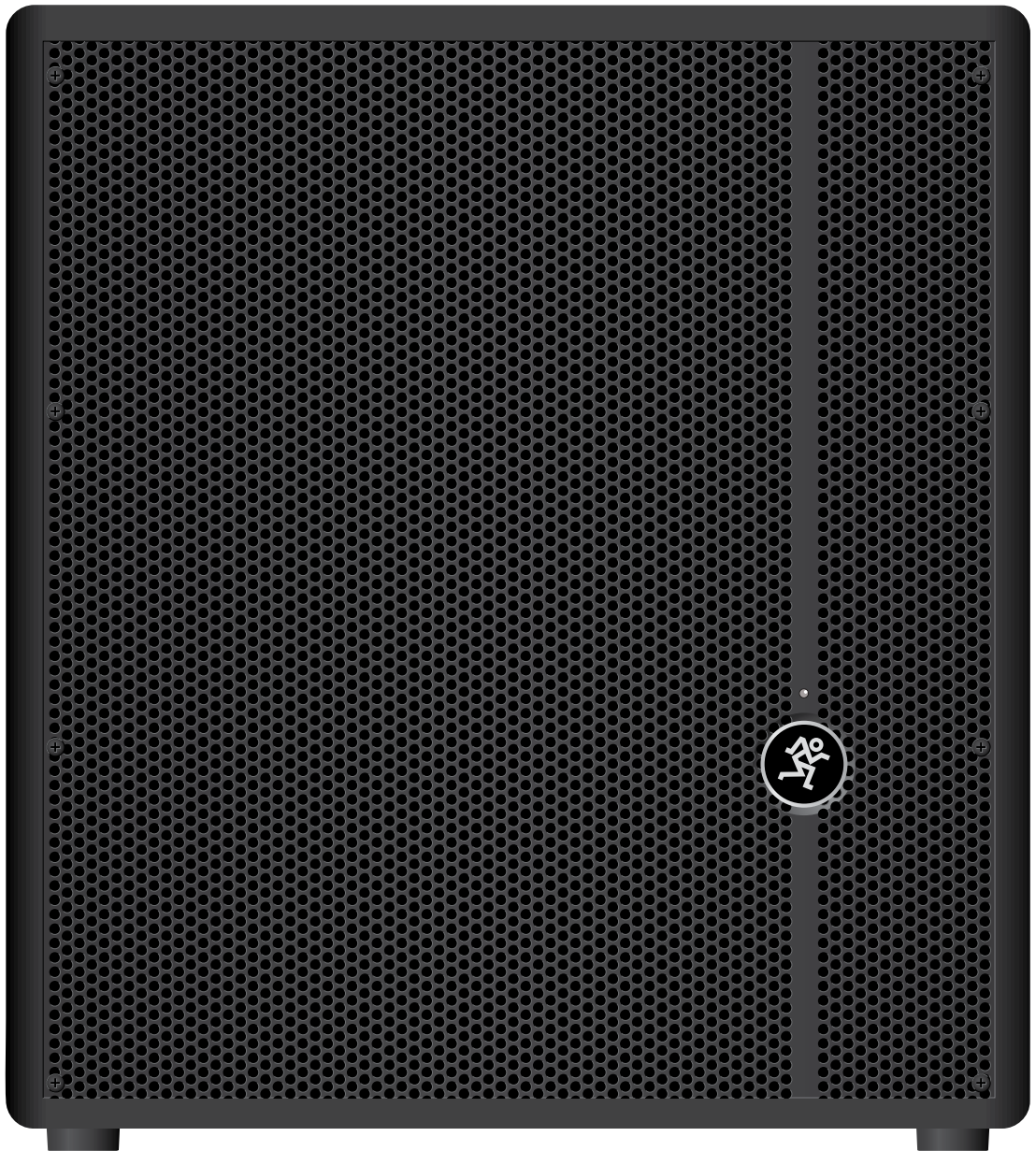

**MACKIE®**

# Important Safety Instructions

1. Read these instructions.
2. Keep these instructions.
3. Heed all warnings.
4. Follow all instructions.
5. Do not use this apparatus near water.
6. Clean only with a dry cloth.
7. Do not block any ventilation openings. Install in accordance with the manufacturer's instructions.
8. Do not install near any heat sources such as radiators, heat registers, stoves, or other apparatus (including amplifiers) that produce heat.
9. Do not defeat the safety purpose of the polarized or grounding-type plug. A polarized plug has two blades with one wider than the other. A grounding-type plug has two blades and a third grounding prong. The wide blade or the third prong are provided for your safety. If the provided plug does not fit into your outlet, consult an electrician for replacement of the obsolete outlet.
10. Protect the power cord from being walked on or pinched particularly at plugs, convenience receptacles, and the point where they exit from the apparatus.
11. Only use attachments/accessories specified by the manufacturer.
12. Use only with a cart, stand, tripod, bracket, or table specified by the manufacturer, or sold with the apparatus. When a cart is used, use caution when moving the cart/apparatus combination to avoid injury from tip-over.
13. Unplug this apparatus during lightning storms or when unused for long periods of time.
14. Refer all servicing to qualified service personnel. Servicing is required when the apparatus has been damaged in any way, such as power-supply cord or plug is damaged, liquid has been spilled or objects have fallen into the apparatus, the apparatus has been exposed to rain or moisture, does not operate normally, or has been dropped.
15. This apparatus shall not be exposed to dripping or splashing, and no object filled with liquids, such as vases or beer glasses, shall be placed on the apparatus.
16. Do not overload wall outlets and extension cords as this can result in a risk of fire or electric shock.
17. This apparatus has been designed with Class-I construction and must be connected to a mains socket outlet with a protective earthing connection (the third grounding prong).
18. This apparatus has been equipped with an all-pole, rocker-style AC mains power switch. This switch is located on the rear panel and should remain readily accessible to the user.



19. NOTE: This equipment has been tested and found to comply with the limits for a Class B digital device, pursuant to part 15 of the FCC Rules. These limits are designed to provide reasonable protection against harmful interference in a residential installation. This equipment generates, uses, and can radiate radio frequency energy and, if not installed and used in accordance with the instructions, may cause harmful interference to radio communications. However, there is no guarantee that interference will not occur in a particular installation. If this equipment does cause harmful interference to radio or television reception, which can be determined by turning the equipment off and on, the user is encouraged to try to correct the interference by one or more of the following measures:
  - Reorient or relocate the receiving antenna.
  - Increase the separation between the equipment and the receiver.
  - Connect the equipment into an outlet on a circuit different from that to which the receiver is connected.
  - Consult the dealer or an experienced radio/TV technician for help.

CAUTION: Changes or modifications to this device not expressly approved by LOUD Technologies Inc. could void the user's authority to operate the equipment under FCC rules.

20. This apparatus does not exceed the Class A/Class B (whichever is applicable) limits for radio noise emissions from digital apparatus as set out in the radio interference regulations of the Canadian Department of Communications.

**ATTENTION** — *Le présent appareil numérique n'émet pas de bruits radioélectriques dépassant les limites applicables aux appareils numériques de class A/de class B (selon le cas) prescrites dans le règlement sur le brouillage radioélectrique édicté par les ministere des communications du Canada.*

21. Exposure to extremely high noise levels may cause permanent hearing loss. Individuals vary considerably in susceptibility to noise-induced hearing loss, but nearly everyone will lose some hearing if exposed to sufficiently intense noise for a period of time. The U.S. Government's Occupational Safety and Health Administration (OSHA) has specified the permissible noise level exposures shown in the following chart. According to OSHA, any exposure in excess of these permissible limits could result in some hearing loss. To ensure against potentially dangerous exposure to high sound pressure levels, it is recommended that all persons exposed to equipment capable of producing high sound pressure levels use hearing protectors while the equipment is in operation. Ear plugs or protectors in the ear canals or over the ears must be worn when operating the equipment in order to prevent permanent hearing loss if exposure is in excess of the limits set forth here:

Duration, per day in hours	Sound Level dBA, Slow Response	Typical Example
8	90	Duo in small club
6	92	
4	95	Subway Train
3	97	
2	100	Very loud classical music
1.5	102	
1	105	Greg and Ben screaming at Troy about deadlines
0.5	110	
0.25 or less	115	Loudest parts at a rock concert

**CAUTION AVIS**

RISK OF ELECTRIC SHOCK. DO NOT OPEN  
RISQUE DE CHOC ELECTRIQUE. NE PAS OUVRIR

CAUTION: TO REDUCE THE RISK OF ELECTRIC SHOCK DO NOT REMOVE COVER (OR BACK) NO USER-SERVICEABLE PARTS INSIDE. REFER SERVICING TO QUALIFIED PERSONNEL  
ATTENTION: POUR EVITER LES RISQUES DE CHOC ELECTRIQUE, NE PAS ENLEVER LE COUVERCLE. AUCUN ENTRETIEN DE PIECES INTERIEURES PAR L'USAGER. CONFIER L'ENTRETIEN AU PERSONNEL QUALIFIE.  
AVIS: POUR EVITER LES RISQUES D'INCENDIE OU D'ELECTROCUTION, N'EXPOSEZ PAS CET ARTICLE A LA PLUIE OU A L'HUMIDITE

The lightning flash with arrowhead symbol within an equilateral triangle is intended to alert the user to the presence of uninsulated "dangerous voltage" within the product's enclosure, that may be of sufficient magnitude to constitute a risk of electric shock to persons.  
*Le symbole éclair avec point de flèche à l'intérieur d'un triangle équilatéral est utilisé pour alerter l'utilisateur de la présence à l'intérieur du coffret de "voltage dangereux" non isolé d'ampleur suffisante pour constituer un risque d'électrocution.*

The exclamation point within an equilateral triangle is intended to alert the user of the presence of important operating and maintenance (servicing) instructions in the literature accompanying the appliance.  
*Le point d'exclamation à l'intérieur d'un triangle équilatéral est employé pour alerter les utilisateurs de la présence d'instructions importantes pour le fonctionnement et l'entretien (service) dans le livret d'instruction accompagnant l'appareil.*

**WARNING** — To reduce the risk of fire or electric shock, do not expose this apparatus to rain or moisture.

# Contents

<b>IMPORTANT SAFETY INSTRUCTIONS</b>	<b>2</b>	<b>AC POWER</b>	<b>11</b>
<b>CONTENTS</b>	<b>3</b>	<b>CARE AND MAINTENANCE</b>	<b>11</b>
<b>FEATURES</b>	<b>3</b>	<b>APPENDIX A: SERVICE INFORMATION</b>	<b>12</b>
<b>INTRODUCTION</b>	<b>3</b>	<b>APPENDIX B: CONNECTIONS</b>	<b>13</b>
<b>HOOKUP DIAGRAMS</b>	<b>4</b>	<b>APPENDIX C: TECHNICAL INFORMATION</b>	<b>14</b>
<b>REAR PANEL FEATURES</b>	<b>7</b>	<b>HD1501 GRAPHS AND DIMENSIONS</b>	<b>15</b>
<b>INS AND OUTS OF POLARITY</b>	<b>10</b>	<b>HD1501 BLOCK DIAGRAM</b>	<b>16</b>
<b>PLACEMENT</b>	<b>11</b>	<b>HD1501 LIMITED WARRANTY</b>	<b>17</b>
<b>THERMAL CONSIDERATIONS</b>	<b>11</b>		

## Features

- 1200W of ultra-efficient Class-D Fast Recovery™ amplification
  - 600W RMS / 1200W peak power
  - 131 dB SPL max output (peak @ 1m)
  - 36 Hz - 145 Hz operating range
- 15" high-output woofer with 3" voice coil
- Active electronics provide complete system optimization
  - Symmetrical Linkwitz-Riley crossover (100 Hz, 24 dB/octave)
  - Precision tuning filters for ultra-accurate bass reproduction
  - Phase alignment to perfectly complement Mackie full-range loudspeakers
- Ported, direct-radiating design for maximum punch and low-frequency extension
- Designed and tuned by Eastern Acoustic Works
- Dual XLR inputs, full-range and high-pass outputs for mono or stereo setups
- Level control and polarity invert switch with LED indicator
- Signal / limit and thermal LED indicators
- Integrated protection and limiting circuitry
- Rugged all-wood cabinet (15 mm birch plywood)
- Pole mount receptacle for mounting full-range speaker
- Compact and lightweight (80 lb / 36.3 kg)

## Introduction

Thank you for choosing the Mackie HD1501 subwoofer. Mackie HD Series Powered Subwoofers provide intense low-frequency extension and punch to any Mackie full-range system. Designed and tuned by the experts at EAW, HD1501 subs deliver 1200W peak power via high-output 15" drivers custom-designed for optimal pairing with Mackie full-range loudspeakers. The HD1501 incorporates Mackie-standard professional components like efficient Class-D Fast Recovery™ amplifiers and system-optimizing Active electronics so that everything sounds great right out of the box.

Premium circuitry includes a symmetrical Linkwitz-Riley crossover, precision tuning filters and user-friendly features like high pass outputs for stereo operation with a single sub. The 15mm birch plywood enclosures feature a ported, direct-radiating design for chest-pounding punch. Pair the HD1501 with any Mackie full-range loudspeaker for an extremely powerful and fully high-definition PA solution.

Paired with a Mackie HD1521, you have a complete (and completely affordable) "plug and play" system that is ideal for small clubs, DJs and rehearsal spaces. It is also a great match when paired with the popular Mackie SRMv2 Series and can easily integrate into nearly any existing PA setup. The HD1501 has both full-range and high-pass stereo outputs for connection to full-range top boxes. Just dial in the appropriate level and use the polarity switch to make sure the sub is in phase with the loudspeakers. The integrated pole-cup can accommodate a standard mounting pole, so your favorite speaker has a nice place to sit. Or you can just stack your full-range box right on top of the sub...the HD1501 ain't picky.

So if you are looking for an extremely powerful, affordable PA setup that is simple to use, then you're in the right place. Read on to learn everything you could possibly want to know about your new subwoofer.

# Hookup Diagrams

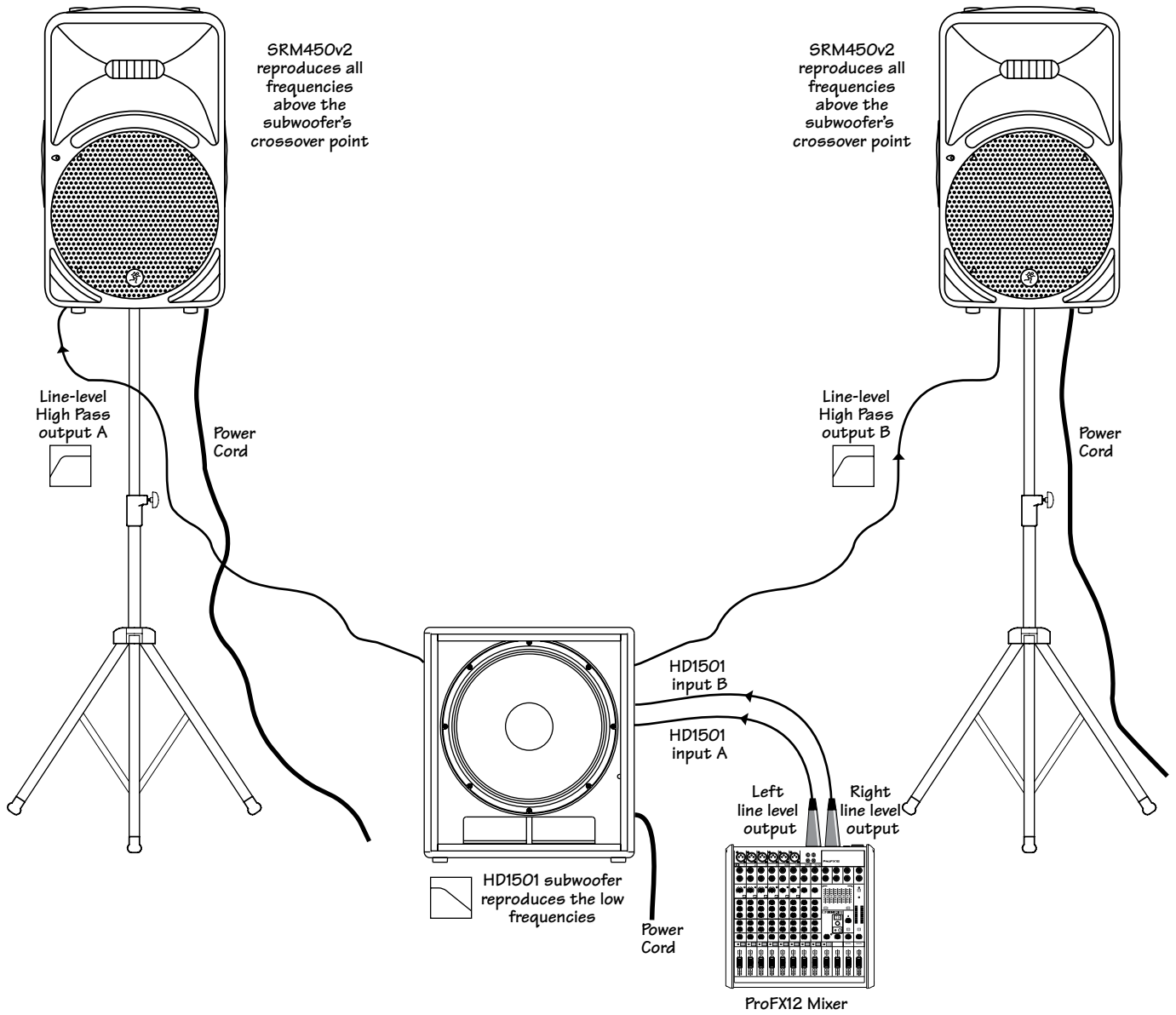

*This diagram shows the left line level output of a Mackie ProFX12 mixer feeding inputs A and B of one Mackie HD1501 subwoofer. Two SRM450v2 powered loudspeaker inputs are fed from the A and B High Pass outputs from the subwoofer. Experiment with the HD1501's polarity switch to achieve optimum performance. Placement of the subwoofer relative to the full-range loudspeakers will also affect performance. See page 10 for more information.*

## HD1501: 3-WAY MONO SUB SYSTEM WITH SRM450V2 LOUDSPEAKERS

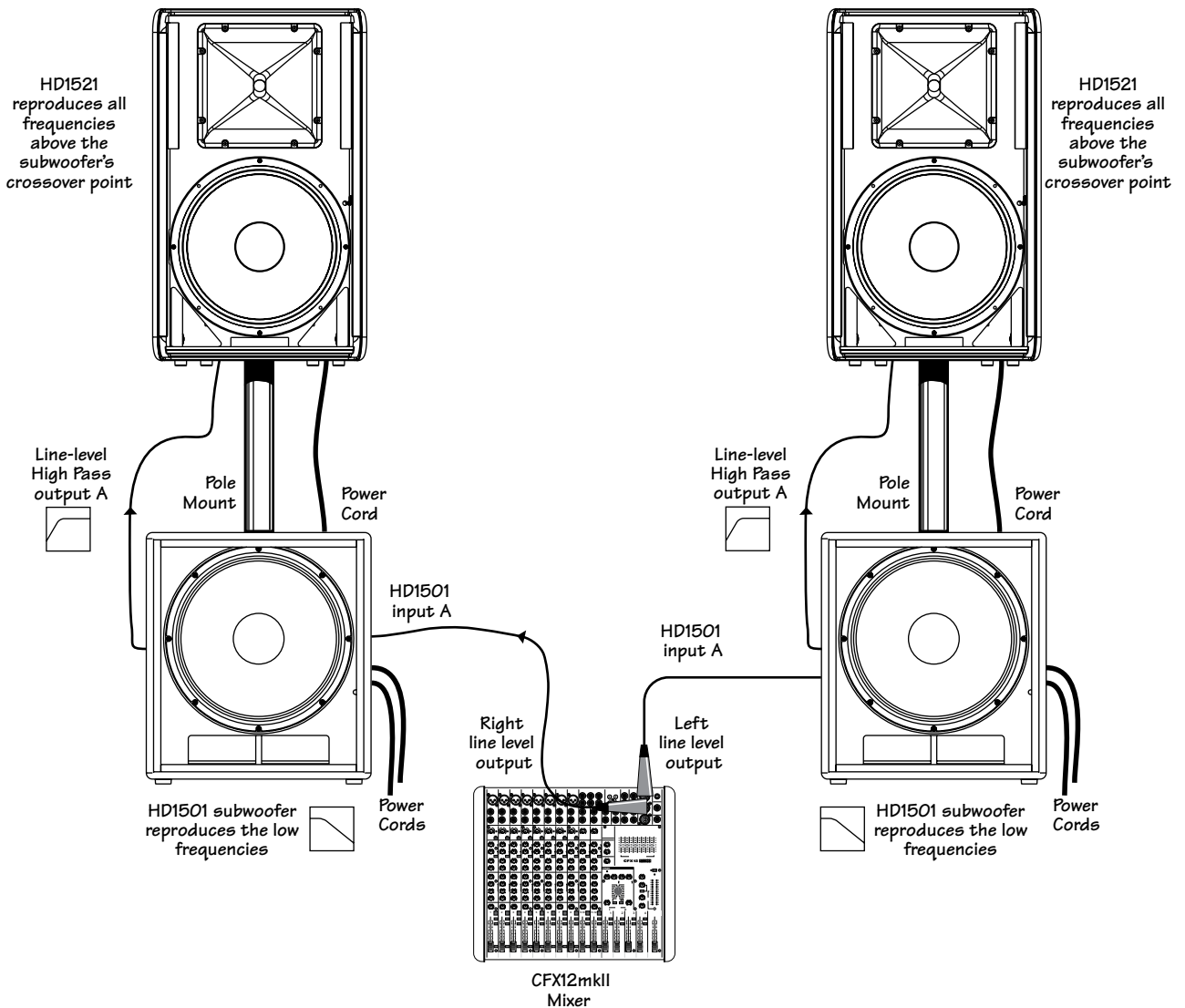

This diagram shows the left and right line level outputs of a Mackie CFX12mkII mixer feeding input A of two Mackie HD1501 subwoofers. The High Pass output A of each subwoofer then feeds the input of each Mackie HD1521 powered loudspeaker. Experiment with the HD1501's polarity switch to achieve optimum performance. Placement of the subwoofer relative to the full-range loudspeakers will also affect performance. See page 10 for more information.

## HD1501: STEREO 3-WAY SYSTEM WITH HD1521 LOUDSPEAKERS

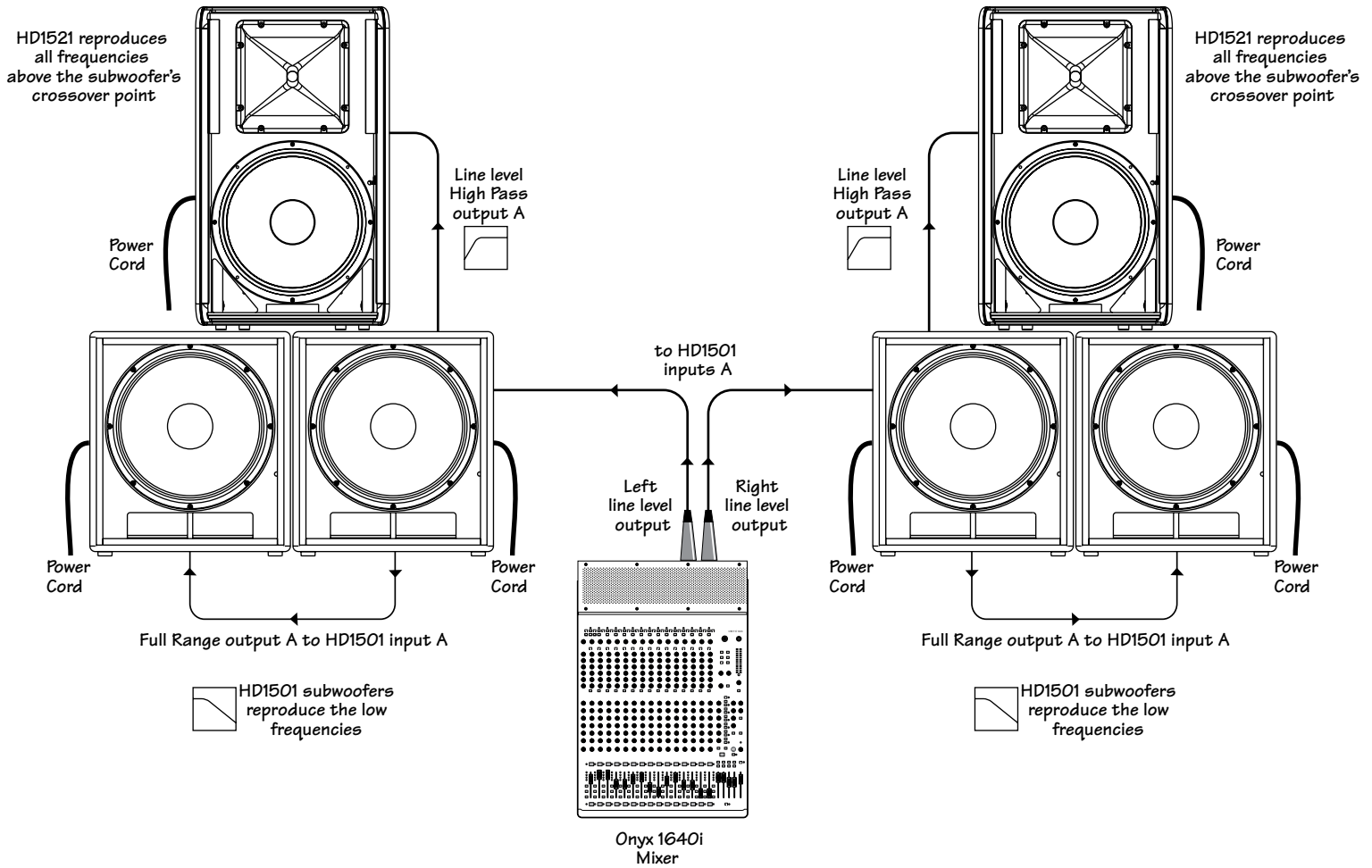

*This diagram shows the left and right line level outputs of a Mackie Onyx 1640i mixer feeding input A of two Mackie HD1501 subwoofers. The Full Range output A of each subwoofer then feeds input A of another pair of Mackie HD1501 subwoofers. The High Pass output A of these subwoofers also feed the input of each Mackie HD1521 loudspeaker. Be sure to disengage the Polarity Invert switch on the HD1501 subwoofers to optimize performance. See page 10 for more information.*

**HD1501: STEREO 4-WAY SYSTEM WITH HD1521 LOUDSPEAKERS AND DUAL SUBWOOFERS**

# Rear Panel Features

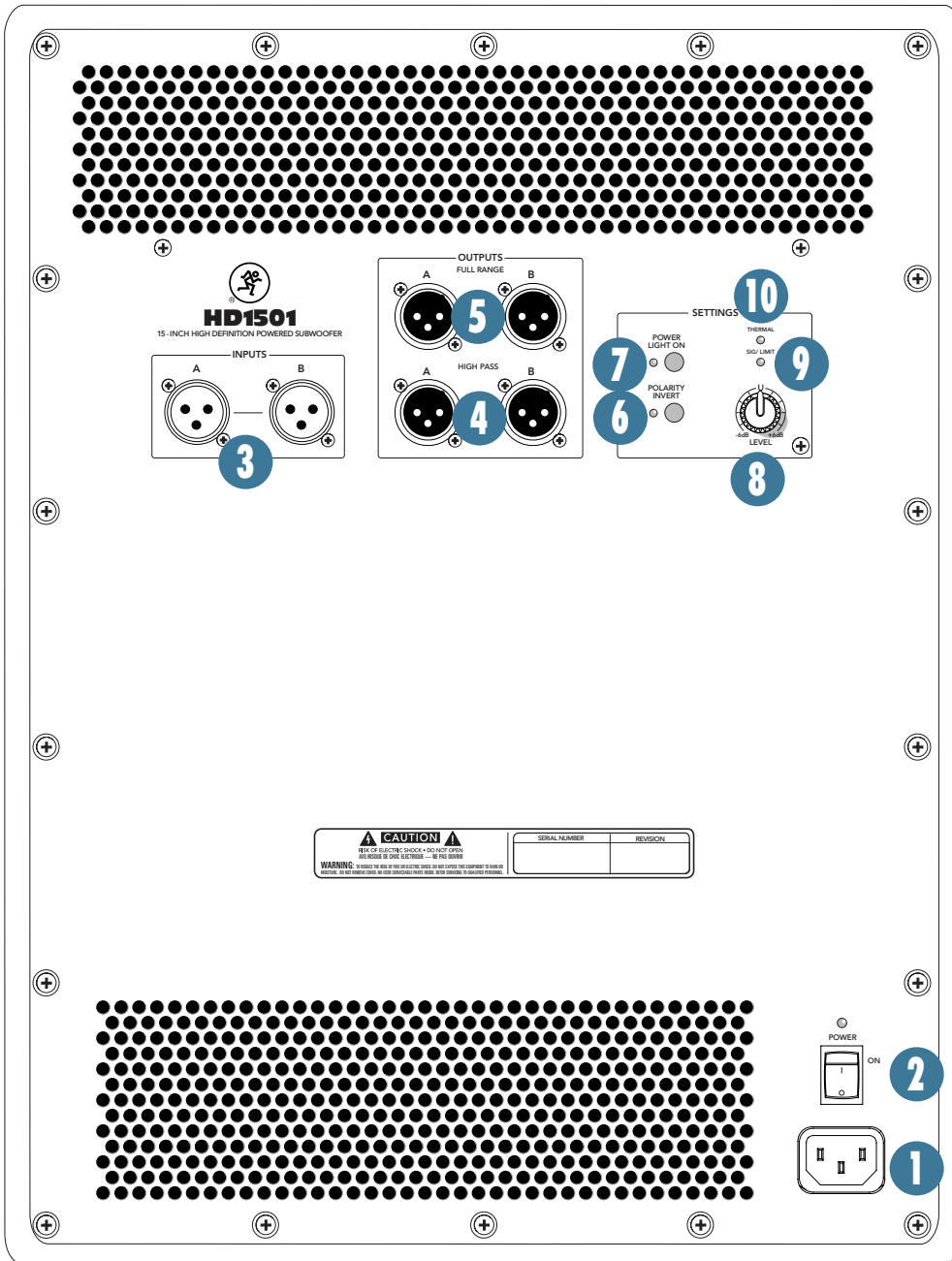

## 1. IEC AC Receptacle

This jack accepts the supplied 3-prong AC power cord.



Before you plug the AC power cord into the powered subwoofer, make sure that the voltage of your unit is the same voltage as your local AC mains supply. Use only the power cord supplied. Also, disconnecting the plug's ground pin is dangerous. Don't do it.

## 2. POWER

Use this switch to turn the HD1501 on and off. The LED above the switch will illuminate when powered on. The front panel LED will also turn on, but only if the POWER LIGHT ON switch (7) is engaged. Press the bottom of this switch to turn the subwoofer off.



As a general guide, powered subwoofers should be turned on after the mixer and other sources, but prior to full-range speakers.

Additionally, they should also be powered off after the tops, but before the mixer and other sources. This will reduce the possibility of any turn-on, or turn-off thumps in your speakers.



# HD1501

15-INCH HIGH DEFINITION POWERED SUBWOOFER

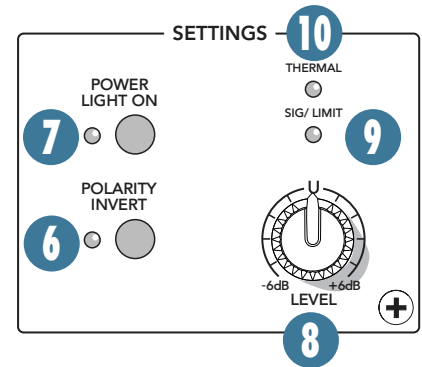
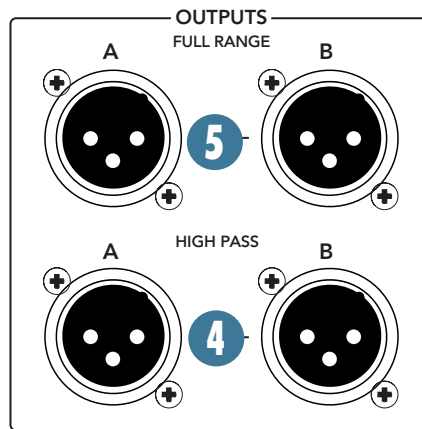
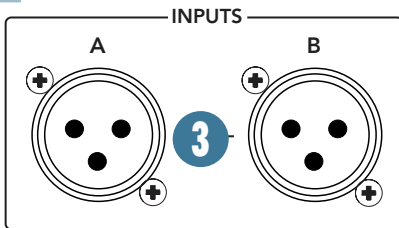

## 3. INPUTS

These female XLR connectors accept balanced line-level signals from a mixing console or other signal source.

If you are connecting a single subwoofer output, or LFE (low-frequency effects) output to the subwoofer, you may use either the A or B input connector.



**CAUTION:** NEVER connect the output of an amplifier directly to the input of the subwoofer. This could damage the input circuitry of the powered subwoofer.

## 4. HIGH PASS OUTPUTS

Balanced XLR male connectors are provided for the line-level A and B high-pass outputs. The subwoofer's internal active crossover splits the input signals into two frequency bands. The low frequency range below 100 Hz goes to the internal amplifier that powers the subwoofer. The frequency range above 100 Hz is sent to these line-level output jacks.

Connect these outputs to the inputs of your main powered loudspeakers, or to the inputs of the amplifier powering the main loudspeakers. In this way, the main loudspeakers will play the range above 100 Hz. If the main loudspeakers have good low-frequency response, then you may decide to use the full-range outputs (5) instead.

The level control and polarity switch have no effect on the high-pass outputs. The outputs are separate and maintain the stereo separation of the input signals.

## 5. FULL RANGE OUTPUTS

Balanced XLR male connectors are provided for the line-level A and B full-range outputs. Connect these outputs to the inputs of another powered subwoofer, main powered loudspeakers, or to an amplifier powering passive loudspeakers.

The signal at these outputs is a direct copy of the input signals. These outputs allow you to daisy-chain multiple subwoofers, and/or send the full-range signals to the main loudspeakers.

The level control and polarity switch have no effect on the full-range outputs. The outputs are separate and maintain the stereo separation of the input signals.

## 6. POLARITY INVERT

Press this switch in to invert subwoofer polarity. Depending on the placement of the HD1501 subwoofer relative to the full-range speakers, you may get a better low-frequency response if you invert the polarity of the subwoofer's signal. See page 10 for more information.

## 7. POWER LIGHT ON

Press this switch in to turn on the front panel power LED if a visual indicator is preferred. The LED next to the switch will light as a reminder.

If this switch is out, and the HD1501 is turned on, the LED on the front of the cabinet will not light, nor will the LED next to the switch.

## 8. LEVEL

This controls the overall signal level at the input to the built-in power amplifier. It ranges from -6 dB to +6 dB of gain. The center detent is 0 dB (unity gain).

This control has no effect on the level of the High Pass Outputs (4) or the Full Range Outputs (5).



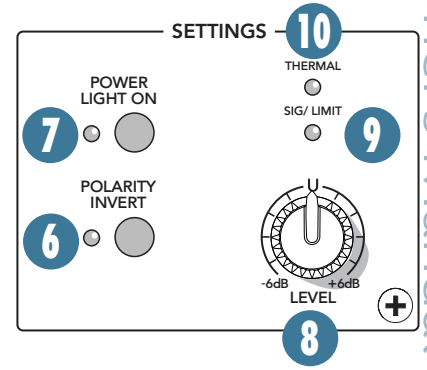
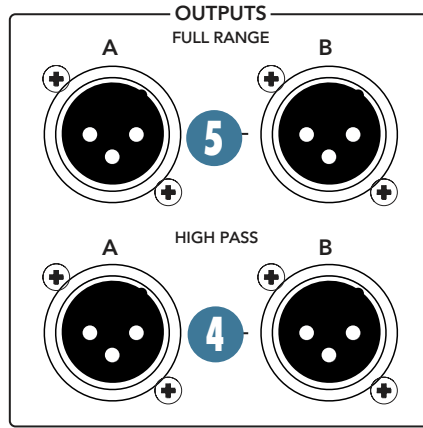
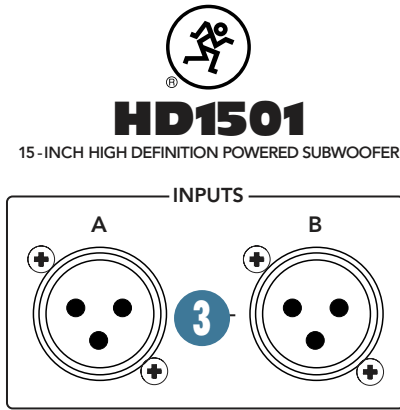

### 9. SIG/LIMIT LED

This bi-color LED illuminates green whenever there is a signal present at the main inputs. It senses the signal just after the level control, so adjustments to the level control will affect the sig/limit indicator.

The HD1501 has a built-in limiter that helps to prevent the amplifier outputs from clipping or overdriving the transducer. The sig/limit indicator lights in yellow when the limiter is activated. It's okay for it to blink yellow occasionally, but if it blinks frequently or lights continuously, turn down the input level until it only blinks occasionally.



Excessive limiting may lead to overheating, which in turn trips the thermal protect circuitry and interrupts the performance. See 'Thermal Considerations' on page 11 for more information.

### 10. THERMAL LED

The HD1501 is equipped with a thermal protection circuit that monitors the internal temperature of the amplifier and heatsink. If the temperature begins to exceed a safe operating level, this indicator lights and the amplifier output is limited to allow the amplifier to cool. If the amplifier becomes excessively hot, the amp is muted until it cools, then the HD1501 returns to normal operation.

When the HD1501 is in thermal protect mode, the power LED (2) will remain lit, indicating that the unit is still powered on despite the lack of output. If POWER LIGHT ON (7) is engaged, the front panel power LED will go out when in thermal protect mode.



Activation of the thermal protection circuit is an indication that you should take steps to avoid continued thermal problems. See "Thermal Considerations" on page 11.

## The Ins and Outs of Polarity

Mackie's HD-Series Powered Subwoofers include a switch that allows you to quickly invert the polarity of the subwoofer's output relative to the input signal it is receiving from the mixer or other sound source. But what exactly does that mean? A subwoofer works by literally pumping air as the woofer cone moves in and out with respect to the cabinet in which it is housed. It does so according to the low-frequency portion of the signal it receives from the sound source.

The woofer cone is simply following the waveform as seen in the sine wave in Figure 1. As the sine wave rises, the woofer cone pushes out. Likewise, as the sine wave falls, the woofer cone pulls into the cabinet. A musical signal is much more complex, of course, but the same principle applies. Movement of the woofer cone causes air pressure changes that we perceive as sound.

When the Polarity Invert switch [6] is engaged, the original waveform is simply reversed 180° (see Figure 2). Again, the subwoofer cone follows the waveform. However, this time the woofer cone starts by pulling into the cabinet followed by the woofer cone pushing out. If you have ever experimented with a subwoofer polarity switch, you may not have noticed any changes to the sound regardless of its position, especially if you are listening to just the subwoofer. This is normal, as our ears perceive them both as the same.

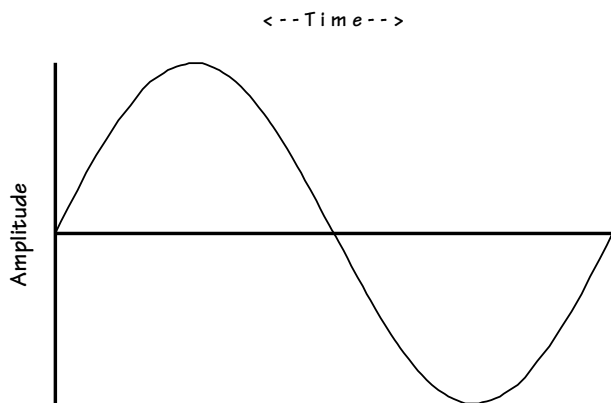

Figure 1

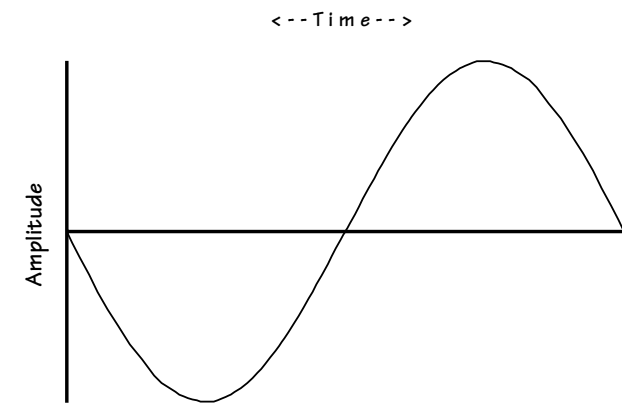

Figure 2

The polarity invert switch comes into play when the HD1501 subwoofer is paired with a loudspeaker. Ideally, the woofer cones of the subwoofer and full-range loudspeaker would work together by pushing and pulling in unison. HD-Series subwoofers are designed to be used in a broad range of applications, and with a wide variety of full-range loudspeakers. The flexibility provided by the polarity switch is necessary to ensure that you are receiving the best possible sound from your system, regardless of your setup.

Listed below are some recommended configurations for pairing a Mackie HD-Series subwoofer (using the High-Pass output) with a Mackie full-range loudspeaker. These settings are a good start, but be sure to experiment to find the best sound for your venue. The loudspeakers may be stacked, pole-mounted, or flown.

- **HD-Series full-range loudspeakers** - Disengage the Polarity Invert switch on the HD1501.
- **SRM450v2 full-range loudspeakers** - Disengage the Polarity Invert switch on the HD1501.

In alternate setups where the full-range loudspeakers are not co-located with the subwoofers or are not connected to the HD-Series subwoofer's High-Pass outputs, you will need to experiment with the Polarity Invert switch to determine which setting gives you the desired bass response for your application.

## Placement

The HD1501 subwoofer is designed to sit on the floor or stage. A socket is provided on top of the HD1501 for mounting other Mackie loudspeakers. Use the optional Mackie speaker mounting pole to mount them on the HD1501. See the hookup diagrams starting on page 4.

Check to make sure that the support surface (e.g., floor, etc.) has the necessary mechanical characteristics to support the weight of the loudspeaker(s) and subwoofer(s).

When pole-mounting loudspeakers, be sure that the HD1501 subwoofers are stabilized and secured from falling over or being accidentally pushed over. For stacked scenarios, it is highly suggested that straps are utilized. Failure to follow these precautions may result in damage to the equipment, personal injury, or death.

As with any powered components, protect them from moisture. Avoid installing the subwoofer in places exposed to harsh weather conditions. If you are setting them up outdoors, make sure they are under cover if you expect rain.



The cabinet has no rigging points and is not suitable for rigging. Never attempt to suspend the HD1501 by its handles.

## Thermal Considerations

The HD1501 has a powerful built-in amplifier capable of producing 600 watts of rms power. As an amplifier works, it produces heat. The higher the signal level, the louder and hotter it gets. It is important to dissipate the heat as quickly as possible. This results in increased reliability and longevity for the amplifier.

The amplifier module is cooled by twin thermally-controlled vari-speed fans. In order for this convection cooling system to work efficiently, it is important to provide adequate airspace behind the subwoofer. When positioning the HD1501, we recommend leaving at least six inches of air space behind it.

In the unlikely event of the amplifier overheating, a built-in thermal switch will activate, muting the amplifier's output. When the amplifier has cooled down to a safe operating temperature, the thermal switch resets itself, and the HD1501 resumes normal operation.

If the thermal switch activates frequently, try turning down the level control a notch or two on the mixing console (or the back of the HD1501) to avoid overheating the amplifier. Be aware that direct sunlight and/or hot stage lights may be the cause of an amplifier overheating.

## AC Power

Be sure the HD1501 is plugged into an outlet that is able to supply the correct voltage specified for your model. It will continue to operate at lower voltages, but will not reach full power.

Be sure the electrical service can supply enough amperage for all the components connected to it.

We recommend that a stiff (robust) supply of AC power be used because the amplifier places high current demands on the AC line. The more power that is available on the line, the louder the subwoofer will play and the more peak output power will be available for a cleaner, punchier bass. A suspected problem of "poor bass performance" is often caused by a weak AC supply to the amplifier.



Never remove the ground pin on the power cord or any other component of the HD1501. This is very dangerous.

## Care and Maintenance

Your Mackie subwoofers will provide many years of reliable service if you follow these guidelines:

- Avoid exposing the subwoofers to moisture. If they are set up outdoors, be sure they are under cover if rain is expected.
- Avoid exposure to extreme cold (below freezing temperatures). If you must operate the subwoofers in a cold environment, warm up the voice coils slowly by sending a low-level signal through them for about 15 minutes prior to high-power operation.
- Use a dry cloth to clean the cabinets. Only do this when the power is turned off. Avoid getting moisture into any of the openings of the cabinet, particularly where the driver is located.

# Appendix A: Service Information

If you think your Mackie product has a problem, please check out the following troubleshooting tips and do your best to confirm the problem. Visit the Support section of our website ([www.mackie.com/support](http://www.mackie.com/support)) where you will find lots of useful information such as FAQs and other documentation. You may find the answer to the problem without having to send your Mackie product away.

## Troubleshooting

### No power

- Is it plugged in? Make sure the AC outlet is live (check with a tester or lamp).
- Our next favorite question: Is the power switch on? If not, try turning it on.
- Is the power LED on the rear panel glowing green? If not, make sure the AC outlet is live. If so, refer to “No sound” below.
- The internal AC line fuse may be blown. This is not a user serviceable part. If you suspect the AC line fuse is blown, please see the “Repair” section next.

### No sound

- Is the input level control for the input source turned all the way down? Verify that all the volume controls in the system are properly adjusted.
- Is the signal source working? Make sure the connecting cables are in good repair and securely connected at both ends. Make sure the output volume (gain) control on the mixing console is turned up sufficiently to drive the inputs of the speaker.
- Make sure the mixer does not have a Mute on or a Processor loop engaged. If you find something like this, make sure the volume/gain is turned down before disengaging the offending switch.
- Is the thermal indicator lit red on the rear panel? Make sure there is at least six inches of free space behind the HD1501.

### Poor bass performance

- Check the polarity of the connections between the mixer and the subwoofers. You may have your positive and negative connections reversed at one end of one cable, causing one subwoofer to be out-of-phase.
- Check your subwoofer polarity switches are configured appropriately for your setup. See page 10 for more information.

### Poor sound

- Is it loud and distorted? Make sure that you're not overdriving a stage in the signal chain. Verify that all level controls are set properly.
- Is the input connector plugged completely into the jack? Be sure all connections are secure.

### Noise

- Make sure all connections to the powered subwoofers are good and sound.
- Make sure none of the signal cables are routed near AC cables, power transformers, or other EMI-inducing devices.
- Is there a light dimmer or other SCR-based device on the same AC circuit as the HD1501? Use an AC line filter or plug the HD1501 into a different AC circuit.

### Hum

- Try disconnecting the cable connected to the main input jack. If the noise disappears, it could be a “ground loop,” rather than a problem with the HD1501. Try some of the following troubleshooting ideas:
  - Use balanced connections throughout your system for the best noise rejection.
  - Whenever possible, plug all the audio equipment's linecords into outlets which share a common ground. The distance between the outlets and the common ground should be as short as possible.

# Appendix B: Connections

## Repair

For warranty service, refer to the warranty information on page 17.

Non-warranty service for Mackie products is available at a factory-authorized service center. To locate the nearest service center, visit [www.mackie.com](http://www.mackie.com), click "Support" and select "Locate a Service Center." Service for Mackie products living outside the United States can be obtained through local dealers or distributors.

If you do not have access to our website, you may call the Tech Support department at 1-800-898-3211, Monday-Friday, during normal business hours, Pacific Time, to explain the problem. Tech Support will tell you where the nearest factory-authorized service center is located in your area.

## "XLR" Connectors

The HD1501 has two female XLR inputs that accept balanced line-level signals. When connecting a balanced signal, be sure it's wired per AES (Audio Engineering Society) standards:

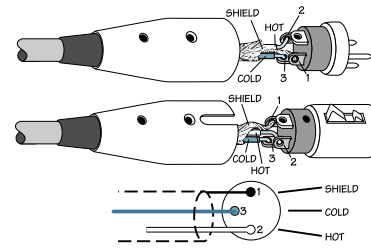

**Balanced XLR Connectors**

### XLR

- Pin 1 – Shield (Ground)
- Pin 2 – Hot (+)
- Pin 3 – Cold (-)

There are also two male XLR connectors on the HD1501 labeled full range. These are also wired according to the AES standards listed above.

The full range connectors allow you to connect several HD1501's. Simply plug the signal source (e.g., mixer output) into the HD1501 input jack, and patch that subwoofer's full range jack to the next subwoofer's input jack, and so on, daisy-chaining multiple subwoofers.



There is a limit to how many you can daisy-chain together. A general rule is to maintain a load impedance ten times or more than the source impedance to prevent excessive loading on the source. For example, if your mixer has an output impedance of 120 ohms, then you can daisy chain up to nine HD1501s. This is a load of 1222 ohms (HD1501 input impedance=11 kohms; 9 of these in parallel=1222 ohms). Since microphones typically have a higher output impedance, you should limit daisy-chaining from a mic source to two HD1501s (assuming that loudspeakers are also connected to the subwoofers).

# Appendix C: Technical Information

## HD1501 Specifications

### Acoustic Performance

Frequency Response (-10 dB):	36 Hz – 145 Hz
Frequency Response (-3 dB):	43 Hz – 92 Hz
Max peak SPL (calculated) <sup>1</sup> :	131 dB
Max peak SPL (measured) <sup>2</sup> :	126 dB

### Transducer

Diameter:	15.0 in / 381 mm
Voice Coil Diameter:	3.0 in / 76 mm
Diaphragm Material:	Paper
Magnet Material:	Ferrite

### Power Amplifier

Rated Power:	600 watts rms 1200 watts peak
THD:	< 0.03%
Design:	Class D
Cooling:	Active, twin thermally controlled vari-speed fans

### Input/Output

Input Type:	Female XLR Balanced differential (stereo left/right)
Input Impedance:	20 k $\Omega$
Full Range Output:	Male XLR Balanced (parallel with input)
High Pass Output:	Male XLR Balanced
Output Impedance:	300 $\Omega$
Level Control:	-6 dB to +6 dB

### Electronic Crossover

Crossover Type:	24 dB/oct. Symmetrical Linkwitz-Riley
Crossover Frequency:	100 Hz

<sup>1</sup> Calculated from peak driver sensitivity and amplifier power, half space.

<sup>2</sup> Measured with swept sine at 1 W within operating range, scaled for max power, half space.

### Protection Features

Over-excursion Protection:	45 Hz 24 dB/oct. Butterworth High Pass Filter
Thermal Protection:	Amplifier mute, auto reset, twin thermally controlled vari-speed fans
Driver Protection:	Peak/RMS Limiter
Display LEDs:	Power Light ON, Polarity Invert, Thermal, Sig/Limit, Front Power ON

### AC Power Requirements

US:	100-120 VAC, 50-60 Hz, 300 watts
Europe:	220-240 VAC, 50-60 Hz, 300 watts
AC Connector:	3-pin IEC 250 VAC, 15 A male

### Construction Features

Basic Design:	Rectangular
Material:	15 mm exterior grade premium birch plywood
Finish:	High durability black paint
Handles:	One on each side
Grille:	Powder-coated galvanized steel

### Physical Properties

Height:	20.0 in / 508 mm
Width:	18.25 in / 464 mm
Depth:	25.0 in / 635 mm
Weight:	80.0 lb / 36.3 kg

### Mounting Methods

Floor mount only

**WARNING:** The cabinet has no rigging points and is not suitable for rigging. **NEVER** attempt to suspend the HD1501 by its handles.

### Disclaimer

Since we are always striving to make our products better by incorporating new and improved materials, components, and manufacturing methods, we reserve the right to change these specifications at any time without notice.

“Mackie” and the “Running Man” figure are registered trademarks of LOUD Technologies Inc.

All other brand names mentioned are trademarks or registered trademarks of their respective holders, and are hereby acknowledged.

## Frequency Response

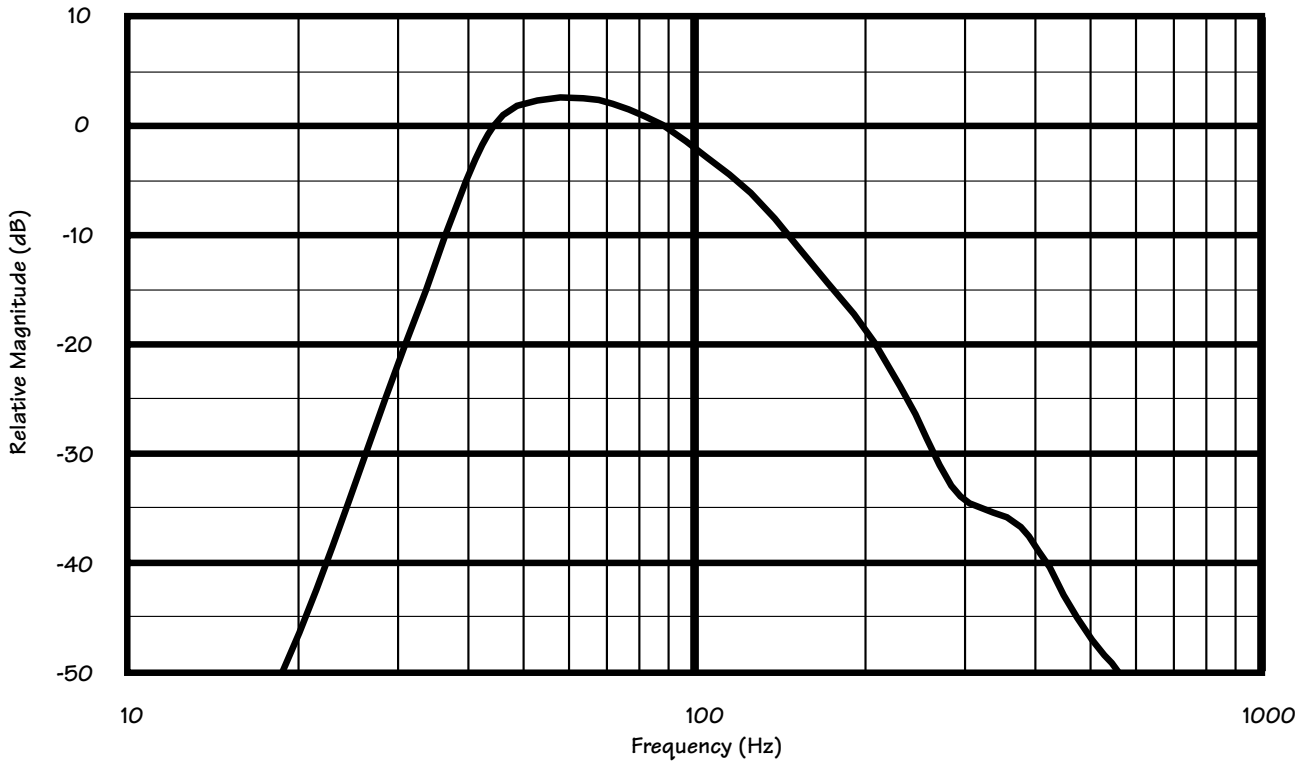

## HD1501 Dimensions

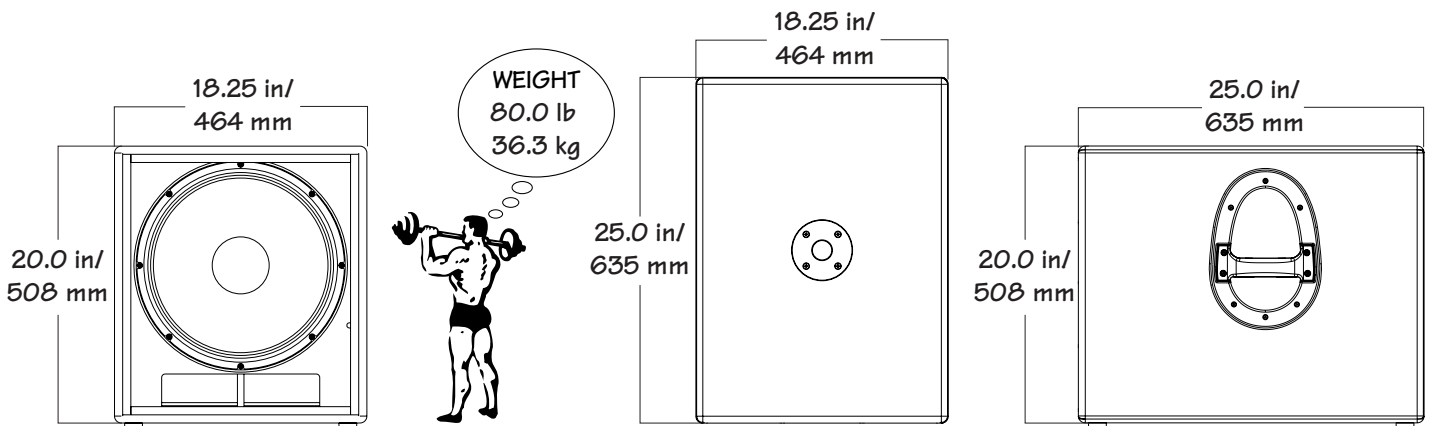

**Correct disposal of this product.** This symbol indicates that this product should not be disposed of with your household waste, according to the WEEE Directive (2002/96/EC) and your national law. This product should be handed over to an authorized collection site for recycling waste electrical and electronic equipment (EEE). Improper handling of this type of waste could have a possible negative impact on the environment and human health due to potentially hazardous substances that are generally associated with EEE. At the same time, your cooperation in the correct disposal of this product will contribute to the effective usage of natural resources. For more information about where you can drop off your waste equipment for recycling, please contact your local city office, waste authority, or your household waste disposal service.

# HD1501 Block Diagram

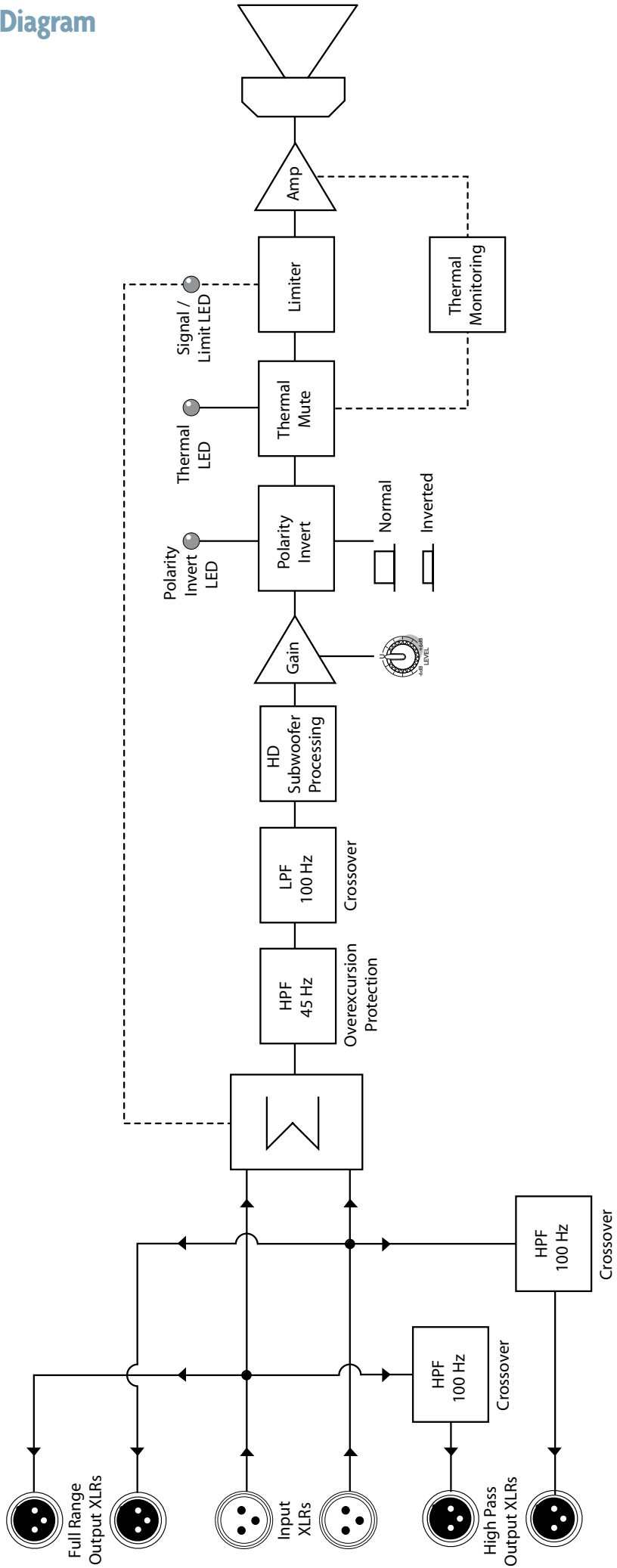



# Mackie Limited Warranty

## Please keep your sales receipt in a safe place.

This Limited Product Warranty ("Product Warranty") is provided by LOUD Technologies Inc. ("LOUD") and is applicable to products purchased in the United States or Canada through a LOUD-authorized reseller or dealer. The Product Warranty will not extend to anyone other than the original purchaser of the product (hereinafter, "Customer," "you" or "your").

For products purchased outside the U.S. or Canada, please visit [www.mackie.com/warranty](http://www.mackie.com/warranty) to find contact information for your local distributor, and information on any warranty coverage provided by the distributor in your local market.

LOUD warrants to Customer that the product will be free from defects in materials and workmanship under normal use during the Warranty Period. If the product fails to conform to the warranty then LOUD or its authorized service representative will at its option, either repair or replace any such nonconforming product, provided that Customer gives notice of the noncompliance within the Warranty Period to the Company at: [www.mackie.com/support](http://www.mackie.com/support) or by calling LOUD technical support at 1.800.898.3211 (toll-free in the U.S. and Canada) during normal business hours Pacific Time, excluding weekends or LOUD holidays. Please retain the original dated sales receipt as evidence of the date of purchase. You will need it to obtain any warranty service.

For full terms and conditions, as well as the specific duration of the Warranty for this product, please visit [www.mackie.com/warranty](http://www.mackie.com/warranty).

The Product Warranty, together with your invoice or receipt, and the terms and conditions located at [www.mackie.com/warranty](http://www.mackie.com/warranty) constitutes the entire agreement, and supersedes any and all prior agreements between LOUD and Customer related to the subject matter hereof. No amendment, modification or waiver of any of the provisions of this Product Warranty will be valid unless set forth in a written instrument signed by the party to be bound thereby.

### Need help with your new powered subwoofer?

- Visit [www.mackie.com](http://www.mackie.com) and click Support to find: FAQs, manuals, and addendums.
- Email us at: [techmail@mackie.com](mailto:techmail@mackie.com).
- Telephone 1-800-898-3211 to speak with one of our splendid technical support chaps (Monday through Friday, normal business hours, PST).

# MACKIE®

16220 Wood-Red Road NE • Woodinville, WA 98072 • USA

United States and Canada: 800.898.3211

Europe, Asia, Central and South America: 425.487.4333

Middle East and Africa: 31.20.654.4000

Fax: 425.487.4337 • [www.mackie.com](http://www.mackie.com)

E-mail: [sales@mackie.com](mailto:sales@mackie.com)

