

User Manual

**MAGNAVOX**  
SMART. VERY SMART.

User Manual	6
Manual del usuario	44
Manual do Usuário	82

## **MRD100**

*DVD VIDEO HOME THEATER SYSTEM*



**México**



Es necesario que lea cuidadosamente su instructivo de manejo.

	<b>PRECAUCION - ADVERTENCIA</b> NO ABRIR, RIESGO DE CHOQUE ELECTRICO	
<b>ATENCION</b> VERIFIQUE QUE EL VOLTAJE DE ALIMENTACION SEA EL REQUERIDO PARA SU APARATO		
PARA EVITAR EL RIESGO DE CHOQUE ELECTRICO, NO quite LA TAPA; EN CASO DE REQUERIR SERVICIO, DIRIJASE AL PERSONAL AUTORIZADO DE PHILIPS.		

Descripción:	<b>Reproductor de Disco de Video Digital</b>
Modelo:	<b>MRD100</b>
Alimentación:	<b>110~127V/220~240V; 50~60Hz</b>
Consumo:	<b>35W</b>
Importador:	<b>Philips Mexicana, S.A. de C.V.</b>
Domicilio:	<b>Av. La Palma No. 6, Col. San Fernando, La Herradura Huixquilucan, Edo de Mexico C.P. 52784, Mexico</b>
Localidad y Tel.:	<b>Tel. 52 69 90 00</b>
Exportador:	<b>Philips Electronics HK, Ltd.</b>
País de Origen:	<b>China</b>
Nº de Serie:	_____

**LEA CUIDADOSAMENTE ESTE INSTRUCTIVO  
ANTES DE USAR SU APARATO.**

## LASER

Type	Semiconductor laser GaAlAs
Wave length	650 - 660 nm (DVD) 784 - 796 nm (CD)
Output Power	7 mW (DVD) 10 mW (VCD/CD)
Beam divergence	60 degrees



**Manufactured under license from Dolby Laboratories, "Dolby", "Pro Logic" and the double-D symbol are trademarks of Dolby Laboratories.**

'CONSUMERS SHOULD NOTE THAT NOT ALL HIGH DEFINITION TELEVISION SETS ARE FULLY COMPATIBLE WITH THIS PRODUCT AND MAY CAUSE ARTIFACTS TO BE DISPLAYED IN THE PICTURE. IN CASE OF 525 OR 625 PROGRESSIVE SCAN PICTURE PROBLEMS, IT IS RECOMMENDED THAT THE USER SWITCH THE CONNECTION TO THE 'STANDARD DEFINITION' OUTPUT. IF THERE ARE QUESTIONS REGARDING OUR TV SET COMPATIBILITY WITH THIS MODEL 525p AND 625p DVD PLAYER, PLEASE CONTACT OUR CUSTOMER SERVICE CENTER.'

This product incorporates copyright protection technology that is protected by method claims of certain U.S. patents and other intellectual property rights owned by Macrovision Corporation and other rights owners. Use of this copyright protection technology must be authorized by Macrovision Corporation, and is intended for home and other limited viewing uses only unless otherwise authorized by Macrovision Corporation. Reverse engineering or disassembly is prohibited.

## CAUTION

*Use of controls or adjustments or performance of procedures other than herein may result in hazardous radiation exposure or other unsafe operation.*

### ATTENTION!

For Customer Use:

Read carefully the information located at the bottom or rear of your DVD Home Theatre System and enter below the Serial No. Retain this information for future reference.

Model No. MRD100

Serial No. \_\_\_\_\_

# Language Code

Abkhazian	6566	Inupiaq	7375	Pushto	8083
Afar	6565	Irish	7165	Russian	8285
Afrikaans	6570	Íslenska	7383	Quechua	8185
Amharic	6577	Italiano	7384	Raeto-Romance	8277
Arabic	6582	Ivrit	7269	Romanian	8279
Armenian	7289	Japanese	7465	Rundi	8278
Assamese	6583	Javanese	7486	Samoan	8377
Avestan	6569	Kalaallisut	7576	Sango	8371
Aymara	6589	Kannada	7578	Sanskrit	8365
Azerhijani	6590	Kashmiri	7583	Sardinian	8367
Bahasa Melayu	7783	Kazakh	7575	Serbian	8382
Bashkir	6665	Kernewek	7587	Shona	8378
Belarusian	6669	Khmer	7577	Shqip	8381
Bengali	6678	Kinyarwanda	8287	Sindhi	8368
Bihari	6672	Kirghiz	7589	Sinhalese	8373
Bislama	6673	Komi	7586	Slovensky	8373
Bokmål, Norwegian	7866	Korean	7579	Slovenian	8376
Bosanski	6683	Kuanyama; Kwanyama	7574	Somali	8379
Brezhoneg	6682	Kurdish	7585	Sotho; Southern	8384
Bulgarian	6671	Lao	7679	South Ndebele	7882
Burmese	7789	Latina	7665	Sundanese	8385
Castellano, Español	6983	Latvian	7686	Suomi	7073
Catalán	6765	Letzeburgesch;	7666	Swahili	8387
Chamorro	6772	Limburgan; Limburger	7673	Swati	8383
Chechen	6769	Lingala	7678	Svenska	8386
Chewa; Chichewa; Nyanja	7889	Lithuanian	7684	Tagalog	8476
中文	9072	Luxembourgish;	7666	Tahitian	8489
Chuang; Zhuang	9065	Macedonian	7775	Tajik	8471
Church Slavic; Slavonic	6785	Malagasy	7771	Tamil	8465
Chuvash	6786	Magyar	7285	Tatar	8484
Corsican	6779	Malayalam	7776	Telugu	8469
Česky	6783	Maltese	7784	Thai	8472
Dansk	6865	Manx	7186	Tibetan	6679
Deutsch	6869	Maori	7773	Tigrinya	8473
Dzongkha	6890	Marathi	7782	Tonga (Tonga Islands)	8479
English	6978	Marshallese	7772	Tsonga	8483
Esperanto	6979	Moldavian	7779	Tswana	8478
Estonian	6984	Mongolian	7778	Türkçe	8482
Euskara	6985	Nauru	7865	Türkmen	8475
Ελληνικά	6976	Navaho; Navajo	7886	Twi	8487
Faroese	7079	Ndebele, North	7868	Uighur	8571
Français	7082	Ndebele, South	7882	Ukrainian	8575
Frysk	7089	Ndonga	7871	Urdu	8582
Fijian	7074	Nederlands	7876	Uzbek	8590
Gaelic; Scottish Gaelic	7168	Nepali	7869	Vietnamese	8673
Galleghan	7176	Norsk	7879	Volapuk	8679
Georgian	7565	Northern Sami	8369	Walloon	8765
Gikuyu; Kikuyu	7573	North Ndebele	7868	Welsh	6789
Guarani	7178	Norwegian Nynorsk;	7878	Wolof	8779
Gujarati	7185	Occitan; Provençal	7967	Xhosa	8872
Hausa	7265	Old Bulgarian; Old Slavonic	6785	Yiddish	8973
Herero	7290	Oriya	7982	Yoruba	8979
Hindi	7273	Oromo	7977	Zulu	9085
Hiri Motu	7279	Ossetian; Ossetic	7983		
Hrvatski	6779	Pali	8073		
Ido	7379	Panjabi	8065		
Interlingua (International)	7365	Persian	7065		
Interlingue	7365	Polski	8076		
Inuktitut	7385	Português	8084		

# Index

---

English ..... 6

Español ..... 44

B. Português ..... 82

English

Español

B. Português

# Table of contents

## General

<b>General Information</b> .....	<b>8</b>
Setup precautions.....	8
Accessories supplied .....	8
Cleaning discs .....	8
About recycling.....	8

## Product Overview

<b>Main Unit</b> .....	<b>9</b>
<b>Remote Control</b> .....	<b>10-12</b>
Using the remote control .....	12

## Connections

<b>Basic Connections</b> .....	<b>13-17</b>
Step 1 : Placing the speakers .....	13
Step 2 : Connecting to the speakers and subwoofer .....	14
Step 3 : Connecting to TV .....	15
Option 1: Using composite video jack (CVBS) .....	15
Option 2: Connecting to a Progressive Scan TV or component video input.....	16
Step 4 : Connecting the FM/AM antennas .....	16
Step 5 : Connecting the power cord .....	17
<b>Optional Connections</b> .....	<b>18</b>
Connecting audio from an analog audio/video device .....	18
Connecting digital audio equipment .....	18

## Basic Setup

<b>Getting Started</b> .....	<b>19-24</b>
Step 1: Turning on the DVD system .....	19
Turning off to standby mode.....	19
Step 2: Finding the correct viewing channel .....	19
Step 3: Setting language preferences .....	20
On-screen display (OSD) language.....	20
Audio, Subtitle and Menu language for DVD playback.....	20-21
Step 4: Setting the TV .....	21
Selecting the matching color system .....	21-22
Setting the TV Display .....	22
Step 5: Setting up progressive scan feature .....	23
Step 6: Setting the speakers' channels .....	24
Speakers delay time.....	24
Speakers volume output level.....	24

## Disc Playback

<b>Disc Operations</b> .....	<b>25-30</b>
Playable discs .....	25
Playing a disc.....	25
Basic playback controls.....	26
Selecting various repeat functions.....	26
Repeating play mode .....	26
Repeating a selection within a chapter/track.....	26
Programming disc tracks .....	27

# Table of contents

Other playback features .....	27
Using the Disc Menu .....	27
Using the Title Menu .....	28
Viewing playback information .....	28
Resuming playback from the last stopped point .....	28
Zooming in .....	28
Changing subtitle language (DVD only) .....	28
Changing sound track language .....	29
Switching camera angles .....	29
Playing an MP3/ JPEG disc .....	29-30
Zoom picture .....	30
Rotating/flipping the picture .....	30
Playing MP3 music and JPEG pictures simultaneously .....	30

## Setup Options

<b>DVD Setup Menu Options .....</b>	<b>31-35</b>
Using the menu bar .....	31
Accessing the DVD setup menu .....	32
picture setup page .....	33
Sound setup Page .....	34
Feature Setup Page .....	35

## Radio Tuning

<b>Tuner Operations .....</b>	<b>36-37</b>
Tuning to radio stations .....	36
Presetting radio stations .....	36
Using auto install .....	36
Using automatic preset .....	37
Using manual preset .....	37
Selecting a preset radio station .....	37
Deleting a preset radio station .....	37
Changing tuning grid .....	37

## Others

<b>Sound and Volume Controls .....</b>	<b>38</b>
Selecting surround sound .....	38
Selecting digital sound effects .....	38
Volume control .....	38
<b>Other Features .....</b>	<b>39</b>
Controlling 'PHILIPS' TV with the remote control .....	39
Dimming systems's display screen .....	39
Setting the sleep timer .....	39
<b>Troubleshooting .....</b>	<b>40-41</b>
<b>Glossary .....</b>	<b>42</b>
<b>Specifications .....</b>	<b>43</b>

## General Information

### CAUTION!

The machine does not contain any user-serviceable parts. Please leave all maintenance work to qualified personnel.

### Setup precautions

#### Finding a suitable location

- Place the set on a flat, hard and stable surface. Do not place the set on a carpet.
- Do not position the set on top of other equipment that might heat it up (e.g., receiver or amplifier).
- Do not put anything under the set (e.g., CDs, magazines).
- Install this unit near the AC outlet where the AC power plug can be easily reached.

#### Space for ventilation

- Place the apparatus in a location with adequate ventilation to prevent internal heat build up. Allow at least 10 cm (4") clearance from the rear and the top of the set and 5cm (2") from the left and right to prevent overheating.

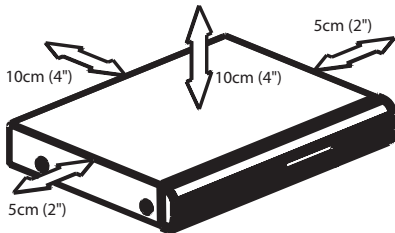

#### Avoid high temperatures, moisture, water and dust

- Apparatus must not be exposed to dripping or splashing.
- Do not place any sources of danger on the apparatus (e.g., liquid filled objects, lighted candles).

### Accessories supplied

- 1 passive subwoofer
- 4 satellite speakers
- 1 center speaker
- 1 remote control with batteries
- 1 video cable
- 1 audio cable
- 1 FM wire antenna
- 1 AM loop antenna
- Quick Start Guide

### Cleaning discs

Some problems occur (frozen picture, sound disruptions, picture distortions) because the disc inside the unit is dirty. To avoid these problems, discs should be cleaned on a regular basis.

To clean a disc, use a micro fiber cleaning cloth and wipe the disc from the center to the edge in a straight line.

### CAUTION!

Do not use solvents such as benzene, thinner, commercially available cleaners, or anti-static sprays intended for discs.

### About recycling

These operating instructions have been printed on non-polluting paper. The electronic equipment contains a large number of materials that can be recycled. If you are disposing of an old machine, please take it to a recycling center. Please observe the local regulations regarding disposal of packaging materials, exhausted batteries and old equipment.



# Main Unit

English

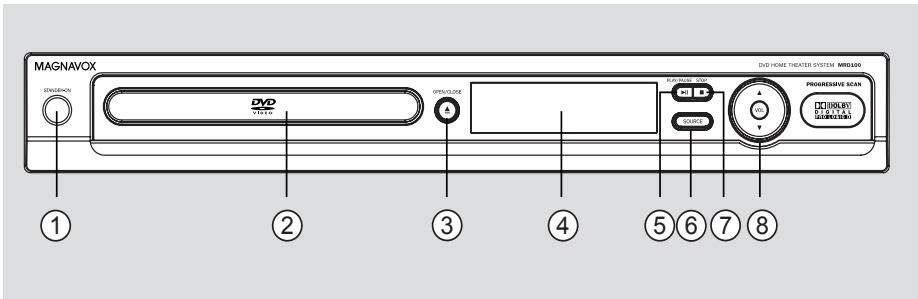

① **STANDBY ON** 

- Turns on the system or turns off to standby mode.

② **Disc tray**

③ **OPEN/CLOSE** 

- Opens/ closes the disc tray.

④ **System display panel**

⑤ **▶|| (PLAY/PAUSE)**

- DISC: starts/pauses playback.
- TUNER: starts auto tuner installation for first time setup.

⑥ **SOURCE**

- Selects the relevant active source mode: DISC, TUNER (FM/AM), TV, AUX or DI.

⑦ **■ (STOP)**

- Exits an operation.
- DISC: stops playback or clears programmed track.
- TUNER: erase the current preset radio station.

⑧ **VOL**  

- Adjusts the volume level.

# Remote Control

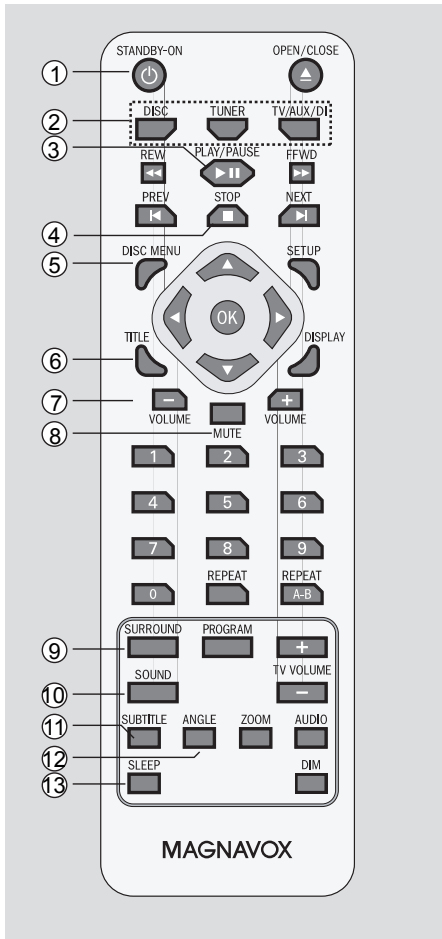

## ① **STANDBY ON**

- Turns on the system or turns off to standby mode.

## ② **Source buttons**

- **DISC**: switches to DISC mode.
- **TUNER**: toggles between FM and AM band.
- **TV/AUX/DI**: switches to TV or the external device which is connected to this system. In TV mode, the sound from the TV will output through the connected speakers system.

## ③ **PLAY/PAUSE**

- DISC: starts/pause playback.

## ④ **STOP**

- Exits an operation.
- DISC: stops playback or clears programed track.
- TUNER: erases the current preset radio station.

## ⑤ **DISC MENU**

- For DVD, enter or exit disc contents menu.
- For VCD(2.0), enter digest menu.

## ⑥ **TITLE**

- Access the title menu (if there is one).

## ⑦ **VOLUME + –**

- Adjusts the volume level.

## ⑧ **MUTE**

- Mutes or restores the volume.

## ⑨ **SURROUND**

- Selects multi-channel surround or stereo mode.

## ⑩ **SOUND**

- Selects a preferred sound effect.

## ⑪ **SUBTITLE**

- Selects a DVD subtitle language.

## ⑫ **ANGLE**

- Selects a DVD disc camera angle (if available).

## ⑬ **SLEEP**

- Sets the sleep timer function.

## Remote Control (continued)

- ⑭ **OPEN/CLOSE ▲**
  - Open or close the disc tray.
- ⑮ **REW ◀◀ / FFWD ▶▶**
  - DISC: fast backward and forward search.
  - TUNER: tune the radio frequency down/up.
- ⑯ **PREV ◀◀ / NEXT ▶▶**
  - DISC: direct access the previous/next chapter or track.
  - TUNER: select a preset radio station.
- ⑰ **SETUP**
  - Enters or exits the system setup menu.
- ⑱ ◀◀ ▲ ▼
  - DISC: selects movement direction in the menu.
  - TUNER: press left or right to select a preset radio station.
- ⑲ **OK**
  - Confirms a selection.
- ⑳ **DISPLAY**
  - Displays the current status or disc information.
- ㉑ **Numeric Keypad (0-9)**
  - Enters a track/title number of the disc.
  - Enters a number of a preset radio station.
- ㉒ **REPEAT A-B**
  - Repeats a specific section on a disc.
- ㉓ **REPEAT**
  - Selects various repeat modes; turns off repeat mode.
- ㉔ **PROGRAM**
  - DISC: starts programming.
  - TUNER: hold down this button to start automatic/manual preset programming.
- ㉕ **TV VOLUME + –**
  - Adjusts TV volume (Philips TV only).

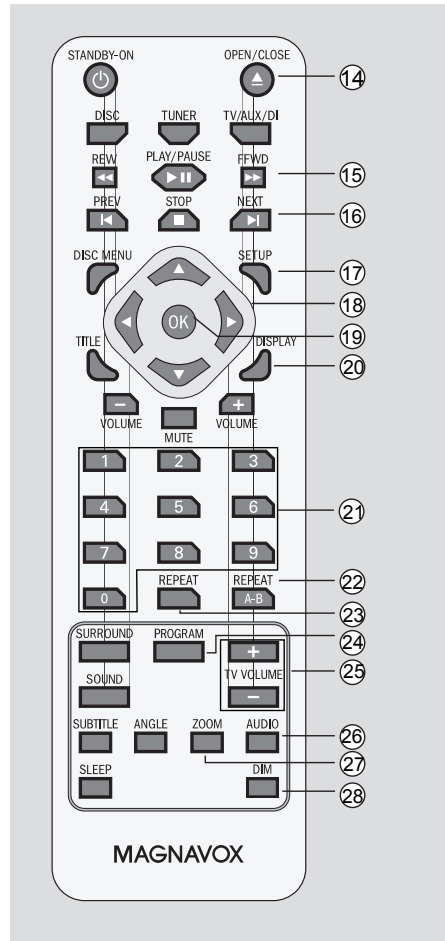

- ㉖ **AUDIO**
  - Selects an audio language (DVD) or an audio channel (VCD).
- ㉗ **ZOOM**
  - Enlarges a picture on the TV screen.
- ㉘ **DIM**
  - Selects different level of brightness for display panel.

## Remote Control (continued)

### Using the remote control

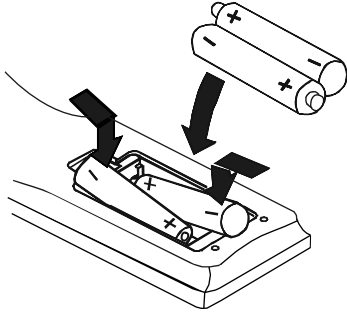

- 1 Open the battery compartment.
- 2 Insert two batteries type R03 or AAA, following the indications (+ -) inside the compartment.
- 3 Close the cover.
- 4 Point the remote control directly at the remote sensor (iR) on the front panel.

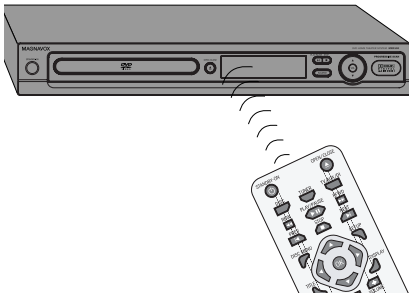

- 5 Select the source you wish to control by pressing the **DISC, TUNER** button on the remote control.
- 6 Then select the desired function (for example ◀◀, ▶▶).

### CAUTION!

- Remove batteries if they are exhausted or if the remote control is not to be used for a long time.
- Do not mix batteries (old and new or carbon and alkaline, etc.).
- Batteries contain chemical substances, so they should be disposed of properly.

## Basic Connections

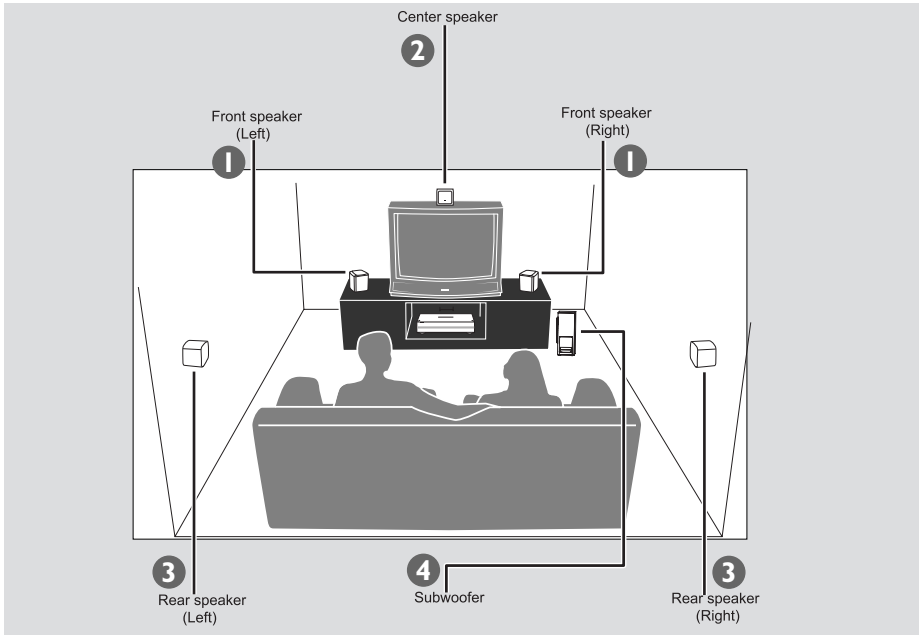

### Step 1: Placing the speakers

This Home Theater System is simple to install. However, proper system placement is critical to ensure an optimum sound experience.

- 1** Place the front left and right speakers at equal distances from the TV and at an angle of approximately 45 degrees from the listening position.
- 2** Place the center speaker above the TV or the DVD system so that the center channel's sound is localized.
- 3** Place the rear speakers at normal listening ear level facing each other or hang on the wall.
- 4** Place the subwoofer at the corner of the room. Keep at least one meter away from the TV.

#### Helpful Hints:

- The placement diagram shown here is only a guideline that will provide great system performance. You may find other placement choices that are more suitable for your room layout and provide the sound experience you enjoy.
- To avoid magnetic interference, do not position the front speakers too close to your TV.
- The rear speakers are labeled as REAR LEFT or REAR RIGHT.
- The front speakers are labeled as FRONT LEFT or FRONT RIGHT.

**TIPS:** Before making or changing any connections, make sure that all the devices are disconnected from the power outlet.

## Basic Connections (continued)

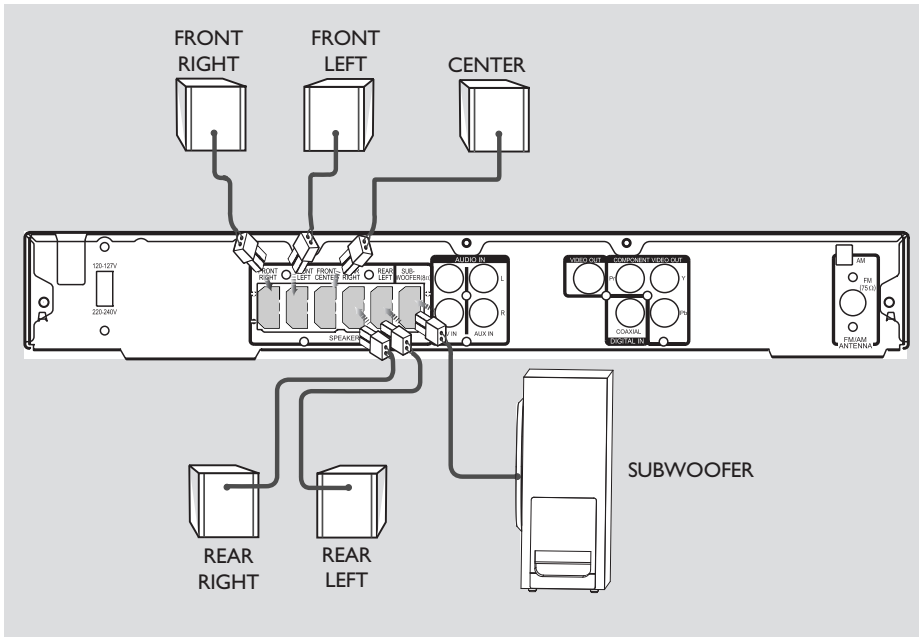

### Step 2: Connecting the speakers and subwoofer

- Connect all the speakers and subwoofer to the speaker jacks at the rear of the DVD system. Make sure that the colors of the plugs and jacks are matched.

#### *Helpful Hint:*

– To prevent unwanted noise, do not place the rear speakers too close to the DVD system, AC power adapter, TV or any other radiation sources.

**TIPS:** Before making or changing any connections, make sure that all the devices are disconnected from the power outlet.

## Basic Connections (continued)

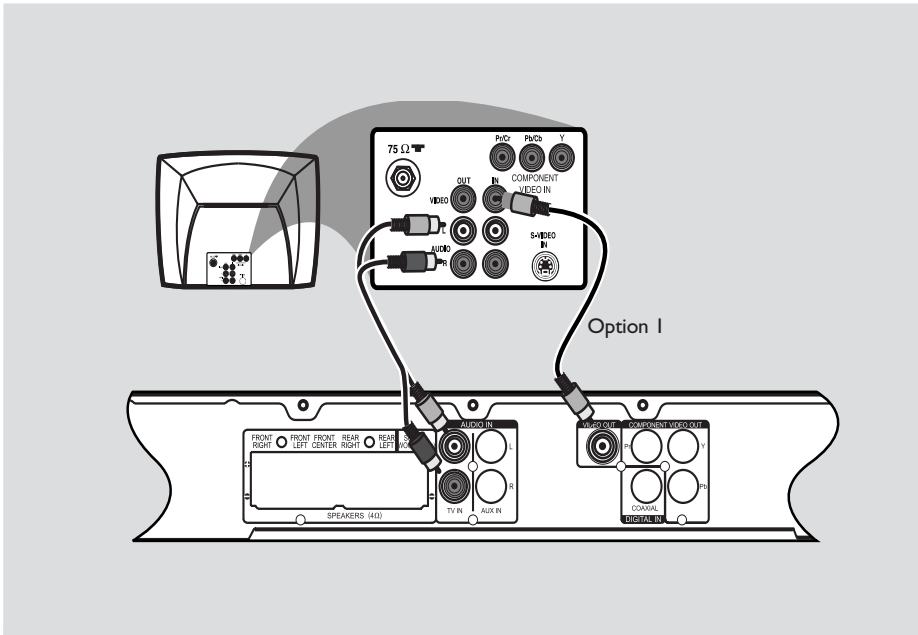

### Step 3: Connecting to TV

This connection enables you to view the playback from this DVD system. You only need to choose **one** of the options below to make your video connection.

- For a standard TV, follow option 1.
- For a progressive scan TV, follow option 2.

**IMPORTANT!**  
Connect the DVD system directly to the TV.

#### Helpful Hint:

– To hear the TV channels through this DVD system, connect the AUDIO IN - TV IN jacks to the corresponding AUDIO output jacks on the TV using an audio cable. Press TV/AUX/IDI on the remote control to select 'TV' when watching the TV programs.

### Option 1: Using Composite Video jacks (CVBS)

- Use the supplied composite video cable (yellow) to connect the **VIDEO OUT** jack on the DVD system to the video input jack (or labeled as A/V In, Video In, Composite or Baseband) on the TV.

**TIPS:** Before making or changing any connections, make sure that all the devices are disconnected from the power outlet.

## Basic Connections (continued)

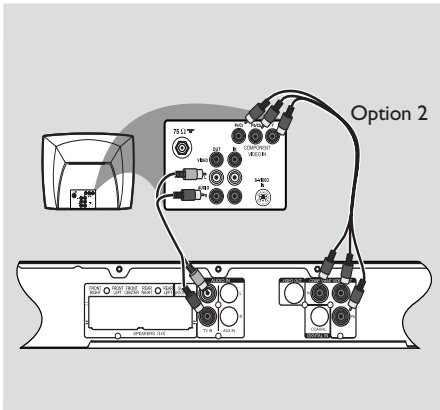

### Option 2: Connecting to a Progressive Scan TV or component video input

The progressive scan video quality is only available when using Y Pb Pr connection and a progressive scan TV is required. It provides superior picture quality when watching DVD movies.

- 1 Follow option 1 to make the basic video connection.
- 2 Use the component video cables (red/blue/green - not supplied) to connect the **Y Pb Pr** jacks on the DVD system to the corresponding component video input jacks (or labeled as Y Pb/Cb Pr/Cr or YUV) on the TV.
- 3 If your TV accepts progressive signals, proceed to 'Getting Started - Step 5: Setting up Progressive Scan feature' for detailed progressive feature setup.

#### Helpful Hint:

– If your TV does not support Progressive Scan, you will not be able to view the picture. Press and hold **OPEN/CLOSE** button, and press '**1**' to deactivate progressive scan.

**TIPS:** Before making or changing any connections, make sure that all the devices are disconnected from the power outlet.

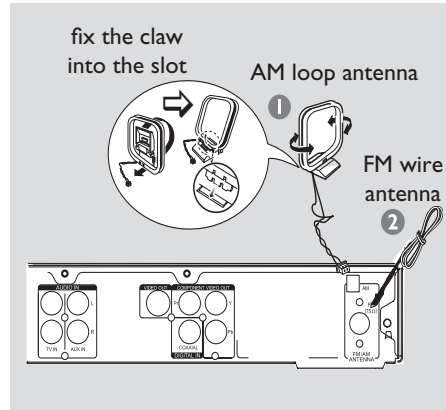

### Step 4: Connecting the FM/AM antennas

- 1 Connect the supplied AM loop antenna to the **AM** jack. Place the AM loop antenna on a shelf, or attach it to a stand or wall.
- 2 Connect the supplied FM antenna to the **FM** jack. Extend the FM antenna and fix its ends to the wall.

For better FM stereo reception, connect an external FM antenna (not supplied).

#### Helpful Hints:

- Adjust the position of the antennas for optimal reception.
- Position the antennas as far away as possible from your TV, VCR or other radiation source to prevent any unwanted interference.



## Basic Connections (continued)

English

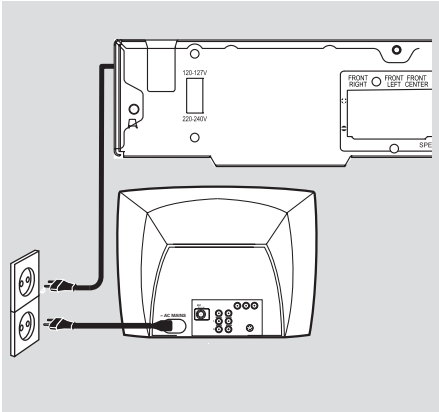

### Step 5: Connecting the power cord

**After everything is connected properly, plug the AC power cord into the power outlet.**

The LED on the DVD system will light up. Never make or change any connections with the power turned on.

*Helpful Hint:*

– Refer to the type plate at the rear or bottom of the product for identification and supply ratings.

**TIPS:** Before making or changing any connections, make sure that all the devices are disconnected from the power outlet.

## Optional Connections

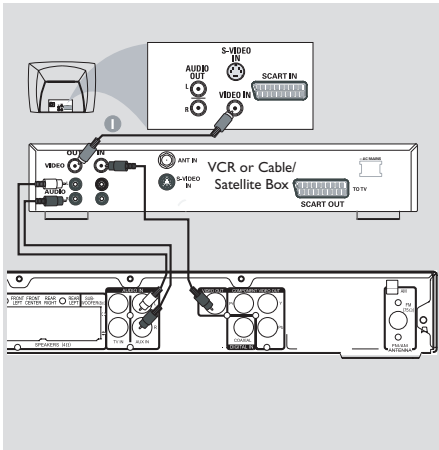

### Connecting audio from an analog audio/video device

You can connect the audio output from an analog audio/video device (e.g. VCR, Cable/Satellite Box) to this Home Theater Audio System in order to enjoy the multi-channel surround sound capabilities

- Use an audio cable (red/white) to connect the **AUX IN** jacks on this DVD system to the AUDIO OUT jacks on an analog audio/video device.

To listen to the sound, press **TV/AUX/DI** repeatedly on the remote control until 'AUX' appears on the display panel.

*Helpful Hint:*

– To see the picture of the connected video device (e.g. VCR), connect the VIDEO OUT jack of the device to the VIDEO IN jack of the TV, and select the correct input channel on the TV.

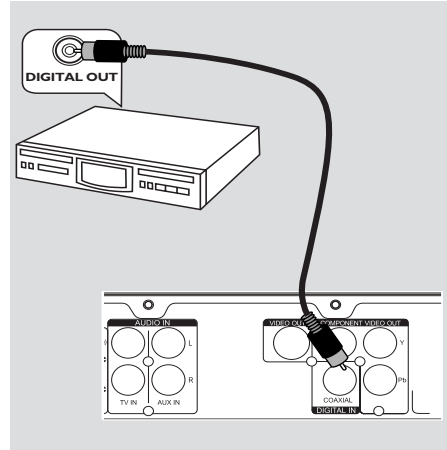

### Connecting digital audio equipment

- Use a coaxial cable (not supplied) to connect the **DIGITAL IN** jack on this DVD system to the DIGITAL OUT jack on the connected device.

To listen to the sound, press **TV/AUX/DI** repeatedly on the remote control until 'DI' appears on the display panel.

*Helpful Hint:*

– For your playback through DIGITAL IN connection, set the digital output of that player to PCM format.

**TIPS:** Refer to the respective connected device's user manual for other possible connections.

# Getting Started

## Step 1: Turning on the DVD system

- 1 Press **STANDBY ON** (⏻).
- 2 Press the **SOURCE** button on the front panel repeatedly to select :  
DISC → FM → AM ...

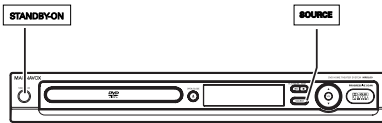

Or

- Press **DISC, TUNER** on the remote control.

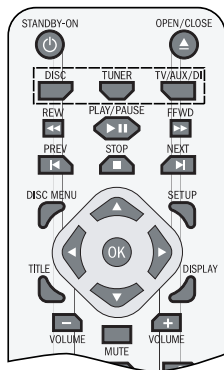

## Turning off to Standby mode

- Press **STANDBY ON** (⏻).  
→ The display screen will turn off.

## Step 2: Finding the correct viewing channel

### Before you start ...

Make sure you have completed all the necessary connections before proceeding.

- 1 Press **SOURCE** button until "DISC" appears on the display panel.
- 2 Turn on the TV and set it to the correct video-in channel. You should see the blue DVD background screen on the TV.  
→ You may go to Channel 1 on your TV, then press the Channel Down button on your TV's remote control until you see the Video In channel.  
→ You may press **CH** button repeatedly on your TV's remote control.  
→ Usually this channel is between the lowest and highest channels and may be called FRONT, A/V IN, VIDEO. See your TV manual for more details.



## Getting Started (continued)

### Step 3: Setting language preferences

The language options are different depending on your country or region. It may not correspond to the illustrations shown on the user manual.

#### On-screen display (OSD) language

The OSD (On-Screen Display) language for this DVD system will remain as you have set it, regardless of the changes made to the DVD disc language.

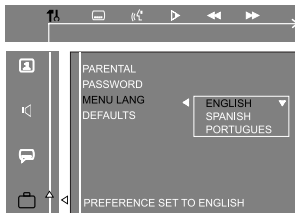

- 1 In 'DISC' mode, press **SETUP** on the remote control.  
→ Use ◀▶▲▼ keys on the remote control to navigate in the menu.
- 2 Highlight  icon and press ▼.  
Move to  and press ▶.
- 3 Move to { **MENU LANG** } and press ▶.



- 4 Use ▲▼ keys to select a language and press **OK** to confirm.

#### Audio, Subtitle and Menu language for DVD playback

You can select your preferred language settings for DVD playback. If the selected language is recorded on the DVD disc, the DVD system will automatically play the disc in that language. Otherwise, the disc's default language will be used instead.

- 1 In disc stop mode press **SETUP**.  
→ Use ◀▶▲▼ keys on the remote control to navigate in the menu.
- 2 Highlight  icon and press ▼.  
Move to  and press ▶.
- 3 Use ▲▼ keys to highlight one of the options below, then press ▶.



#### { AUDIO }

Selects the preferred audio language for DVD playback.

#### { SUBTITLE }

Selects the preferred subtitle language for DVD playback.

#### { DISC MENU }

Selects the preferred disc menu language for DVD playback.

- 4 Use ▲▼ keys to select a language and press **OK** to confirm.
- 5 Repeat steps 3 ~ 4 for other settings.

**TIPS:** Press ◀ to go back to the previous menu item. Press **SETUP** to exit the menu.

## Getting Started (continued)



### Helpful Hints:

- During DVD playback, you can switch the audio and subtitle languages by pressing the **AUDIO** and **SUBTITLE** buttons on the remote control. However, this does not change the default settings you have made here.
- For some DVDs, the subtitle/audio/menu language can only be changed via the DVD disc menu.

### Step 4: Setting the TV

#### Selecting the matching color system

The color system of the DVD system, DVD and TV should match. Only then will it be possible to play a DVD on this system. Before changing the TV system, determine the color system of your TV.

- 1 In 'DISC' mode, press **SETUP** on the remote control.  
→ Use ◀▶▲▼ keys on the remote control to navigate in the menu.
- 2 Highlight  icon and press ▼.  
Move to  and press ▶.
- 3 Move to { **TV SYSTEM** } and press ▶.

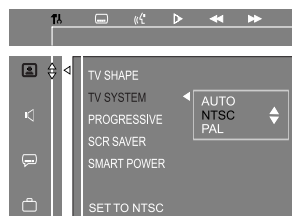

#### { AUTO }

Select this if the connected TV is compatible with both NTSC and PAL (multi-system). The output format will be in accordance with the video signal of the disc.

#### { NTSC }

Select this if the connected TV has the NTSC color system. It will change the video signal of a PAL disc and output it to NTSC format.

**TIPS:** The underlined option is the factory default setting.  
Press ◀ to go back to the previous menu item. Press **SETUP** to exit the menu.

## Getting Started (continued)



### { PAL }

Select this if the connected TV has the PAL color system. It will change the video signal of an NTSC disc and output it to PAL format.

- 4 Select one of the options and press **OK** to confirm.
  - Follow the instructions shown on the TV to confirm the selection (if any).
  - If a blank/distorted TV screen appears, wait for 15 seconds for the auto recovery.

### Setting the TV Display

Set the aspect ratio of the DVD system according to the TV type you have connected. The format you select must be available on the disc. If it is not, the setting for TV display will not affect the picture during playback.

- 1 In 'DISC' mode, press **SETUP** on the remote control.
  - Use ◀▶▲▼ keys on the remote control to navigate in the menu.
- 2 Highlight  icon and press ▼.
  - Move to  and press ▶.
- 3 Move to { **TV SHAPE** } and press ▶.



### { 4:3 PS }

Select this if you have a conventional TV and want both sides of the picture to be trimmed or formatted to fit your TV screen.



### { 4:3 LB }

Select this if you have a conventional TV. In this case, a wide picture with black bands on the upper and lower portions of the TV screen will be displayed.



### { 16:9 }

Select this if you have a wide-screen TV.



- 4 Select one of the options and press **OK** to confirm.

**TIPS:** The underlined option is the factory default setting.  
Press ◀ to go back to the previous menu item. Press **SETUP** to exit the menu.

## Getting Started (continued)



### Step 5: Setting up Progressive Scan feature

(for Progressive Scan TV only)

The progressive scan displays twice the number of frames per second than interlaced scanning (ordinary normal TV system). With nearly double the number of lines, progressive scan offers higher picture resolution and quality.

#### Before you start...

Ensure that you have connected this DVD system to a progressive scan TV using the Y Pb Pr connection (see 'Option 2: Connecting to a Progressive Scan TV or component video input').

- 1 Turn off your TV progressive scan mode or turn on to the interlaced mode (refer to your TV's user manual).
- 2 Turn on the DVD system and press **SOURCE** button until "DISC" appears on the display panel.
- 3 Turn on the TV and set it to the correct video-in channel.  
→ The blue DVD background screen will appear on the TV.
- 4 Press **SETUP** on the remote control.  
→ Use ◀▶▶▲▼ keys on the remote control to navigate in the menu.
- 5 Highlight  icon and press ▼.  
Move to  and press ▶.
- 6 Move to { **PROGRESSIVE** }, select { **ON** } in the menu and press **OK** to confirm.

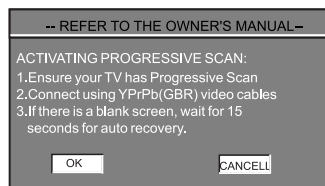

- 7 Read the notification message on the TV and confirm your action by selecting the  in the menu and press **OK**.  
→ If a blank/distorted screen appears, wait for 15 seconds for the auto recovery.
- Otherwise, select { **CANCEL** } and press **OK** to go back to the previous menu.

**There will be no picture on your TV at this state until you have turned on the progressive scan mode on your TV.**

- 8 Turn on your TV progressive scan mode (refer to your TV's user manual).  
→ A message appears on the TV.
- 9 Confirm your action by selecting the  in the menu and press **OK**.  
→ The setup is now completed and you can start to enjoy the high quality picture.

#### If no picture is displayed:

- 1 Press and hold **OPEN CLOSE** on the front panel.
- 2 Press number key { 1 } to deactivate the progressive scan.  
→ The DVD background menu appears.

#### Helpful Hint:

– There are some progressive scan TVs and High-Definition TVs that are not fully compatible with this unit, resulting in an unnatural picture when playing back a DVD VIDEO disc in the progressive scan mode. In this case, turn off the progressive scan feature on both the DVD system and your TV.



**TIPS:** Press ◀ to go back to the previous menu item. Press **SETUP** to exit the menu.

## Getting Started (continued)

### Step 6: Setting the speakers' channels

You can adjust the delay times (center and rear only) and volume level (center, rear and subwoofer) for individual speakers. These adjustments let you optimise the sound according to your surroundings and setup.

#### Speakers delay time

- 1 In 'DISC' mode, press **SETUP** on the remote control.  
→ Use ◀ ▶ ▲ ▼ keys on the remote control to navigate in the menu.
- 2 Highlight  icon and press ▼.  
Move to  and press ▶.
- 3 To help you judge the sound level while adjusting the speaker settings, turn on the test tone. Move to { **TEST TONE** }, select { **ON** } in the menu.

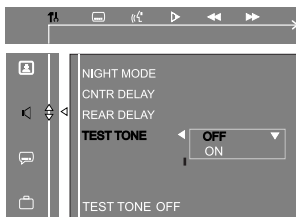

- 4 Use ▲ ▼ to highlight one of the options below at a time, then press ▶.  
{ **CNTR DELAY** }  
Select this to set the delay time in relation to the listening position/distance from the center speaker (5ms, 3ms, 2ms, 1ms or OFF).

#### { **REAR DELAY** }

Select this to set the delay time in relation to the listening position/distance from the rear speakers (15ms, 12ms, 9ms, 6ms, 3ms or OFF).

- 5 Use ◀ ▶ keys to set the delay times that best suit your surround sound needs.
- 6 Press **OK** to confirm.

#### Helpful Hints:

- A 1ms increase/decrease of delay time is equivalent to 30 cm change in distance.
- Use the longer delay time settings when the rear speakers are closer to the listener than the front speakers.

#### Speakers volume output level

- 1 In 'DISC' mode, press **SETUP** on the remote control.
- 2 Press ▶ to select  icon (TRIM LEVEL).



- 3 Press ▼ to select { **REAR SPEAKER** }, { **CENTER SPEAKER** } or { **SUBWOOFER** }.
- 4 Press **VOLUME** + – to adjust the output level between -10dB ~ +10dB.

#### Helpful Hint:

- If you have selected Stereo mode, adjusting the center and rear speakers' volume level will have no effect.

**TIPS:** The underlined option is the factory default setting.  
Press ◀ to go back to the previous menu item. Press **SETUP** to exit the menu.



# Disc Operations

## Playable discs



### Your DVD home theater system will play:

- Digital Versatile Discs (DVDs)
- Video CDs (VCDs)
- Super Video CDs (SVCDs)
- Finalized DVD+Recordable (DVD±R), DVD+Rewritable (DVD±RW)
- Audio Compact Discs (CDs)
- MP3 discs, picture (JPEG) files on CD-R(W)
  - JPG/ISO 9660 format
  - Maximum 12 characters display
  - Supported sampling frequencies : 32 kHz, 44.1 kHz, 48 kHz
  - Supported Bit-rates : 32~256 (kbps), variable bit rates

#### Helpful Hint:

- It may not be possible to play CD-R/RW in all cases due to the type of disc or condition of the recording.

### Region Codes for DVD discs

DVD discs and players are designed with regional restrictions. Before playing a disc, make sure the disc is for the same region as your player. The regional code for this DVD system is indicated at the rear panel.

### IMPORTANT!

- If the inhibit icon (🚫) appears on the TV screen when a button is pressed, it means the function is not available on the current disc or at the current time.
- Do not put any objects other than discs on the disc tray. Doing so may cause the disc player to malfunction.

## Playing a disc

- 1 Press **SOURCE** repeatedly until "DISC" appears on the display panel (or press **DISC** on the remote control).
- 2 Turn on the TV to the Video In channel for the DVD system (e.g. 'EXT', '0', 'AV').  
→ You should see the blue DVD background screen on the TV.
- 3 Press **OPEN CLOSE** ▲ to open the disc tray and load a disc, then press the same button again to close the disc tray.  
→ Make sure the disc label is facing up.  
For double-sided discs, load the side which you want to play facing up.
- 4 Playback will start automatically.  
→ If a disc menu shows on the TV, see page 27 on "Using the Disc Menu".  
→ If the disc is locked by parental control, you must enter your four-digit password (see page 35).  
→ See the following pages for more playback options and features.

#### Helpful Hint:

- If you are having trouble playing a certain disc, remove the disc and try a different one. Improperly formatted discs will not play on this DVD system.

**TIPS:** Some discs cannot be played on this player due to the configuration and characteristics of the disc, or due to the condition of recording and authoring software that was used.

## Disc Operations (continued)

### Basic playback controls

#### Pausing playback

- During playback, press **▶||**.  
→ To resume playback, press **▶||** again.

#### Selecting another track/chapter

- Press **◀ / ▶** or use the **numeric keypad (0-9)** to key in a track/chapter number.  
→ If the repeat track/chapter mode is active, press **◀** will replay the same track/chapter.

#### Searching backward/forward

- Press **◀◀ / ▶▶**.  
→ While searching, press **◀◀ / ▶▶** repeatedly to increase the search speed.  
→ To resume normal playback, press **▶||**.

#### Stopping playback

- Press **STOP ■**.

### Selecting various repeat functions

#### Repeating play mode

- While playing a disc, press **REPEAT** on the remote control repeatedly to choose a repeat play mode.

#### DVD

- RPT CHP (repeat chapter)
- RPT TIT (repeat title)
- RPT OFF (exit repeat mode)

#### VCD/SVCD/CD

- RPT ONE (repeat track)
- RPT DIS (repeat disc)
- RPT OFF (exit repeat mode)

#### MP3

- RPT ONE (repeat track)
- RPT FLD (repeat folder)
- RPT DIS (repeat disc)
- RPT OFF (exit repeat mode)

#### Helpful Hint:

- Repeat playback is not possible on VCDs when the PBC mode is turned on.

#### Repeating a selection within a chapter/ track

- 1 While playing a disc, press **REPEAT A-B** at the starting point.
- 2 Press **REPEAT A-B** again to end the section.  
→ The section A and B can be set only within the same chapter/track.  
→ The section will now repeat continuously.
- 3 Press **REPEAT A-B** again to resume normal playback.

**TIPS:** The operating features described here might not be possible for certain discs. Always refer to the instructions supplied with the discs.

## Disc Operations (continued)

### Programming disc tracks

(for audio CDs and VCDs)

You can play the contents of the disc in the order you want by programming the playing order of the tracks. Up to 99 tracks can be stored.

- 1 Stop playback, press **PROGRAM** on the remote control.  
→ “PROGRAM P00:00” will appear on the display panel.
  - 2 Use the **numeric keypad (0-9)** to enter a valid track/chapter number.
  - 3 Press **OK** to store the track.  
→ “FULL” will appear if you have programmed 99 tracks.
  - 4 Repeat 2 ~ 3 to select other tracks.
  - 5 Press **▶||** to start program playback.
- To clear programmed track, press **STOP ■ twice**.

*Helpful Hint:*

– If the DVD system is disconnected from the power supply, it will erase the program.

### Other playback features

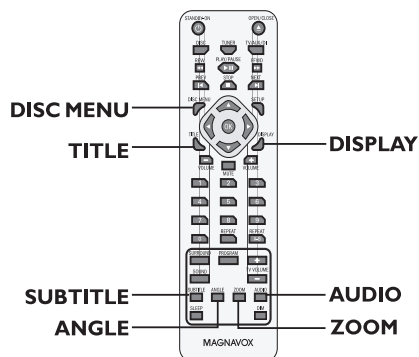

#### Using the Disc Menu

Depending on the disc format, a menu may appear on the TV screen once you load the disc.

#### To select a playback feature or item

- Use **◀▶▲▼** keys or **numeric keypad (0-9)** on the remote control, then press **OK** to start playback.

#### To access or remove the menu

- Press **DISC MENU** on the remote control.

#### For VCD (2.0) with playback control feature (PBC)

- During playback, press **DISC MENU** will return to the main menu screen (if PBC is turned on).

**TIPS:** The operating features described here might not be possible for certain discs. Always refer to the instructions supplied with the discs.

## Disc Operations (continued)

### Using the Title Menu

- 1 While playing a DVD disc, press **TITLE** to display the title menu.
- 2 Use ◀▶▲▼ keys or **numeric keypad (0-9)** on the remote control to make your selection, then press **OK** to start playback.

#### Helpful Hint:

– Depending on the DVD disc, you may not be able to select the title menu.

### Viewing playback information

This DVD system can display the disc playback information (for example, title or chapter number, elapsed playing time) without interrupting disc playback.

- During playback, press **DISPLAY**.

#### DVD

TITLE NUMBER, CHAPTER NUMBER,  
TITLE ELAPSED → TITLE REMAIN →  
CHAPTER ELAPSED → CHAPTER  
REMAIN → OFF

#### VCD (PBC OFF) / SVCD/CD

SINGLE ELAPSED → SINGLE REMAIN  
→ TOTAL ELAPSED → TOTAL REMAIN  
→ OFF

#### MP3

TRACK ELAPSED → TRACK REMAIN  
→ OFF

### Resuming playback from the last stopped point

- When play is stopped and the disc has not been ejected, Press ▶|| to resume playback from the last stopped point.

#### To cancel the resume mode

- When play is stopped, press ■ again.

#### Helpful Hint:

– Opening the disc tray or disconnecting the DVD system from the power supply will cancel the resume option.

### Zooming in

This option allows you to enlarge the picture on the TV screen and to pan through the enlarged picture.

- 1 During playback, press **ZOOM** on the remote control repeatedly to select a different zoom factor.  
→ Use ◀▶▲▼ keys to move through the zoomed image.  
→ Playback will continue.
- 2 Press **ZOOM** repeatedly to return to the original size.

### Changing subtitle language (DVD only)

This operation works only on DVDs with multiple subtitle languages. You can change the language you want while playing a DVD.

- Press **SUBTITLE** repeatedly to select different subtitle languages.

**TIPS:** The operating features described here might not be possible for certain discs. Always refer to the instructions supplied with the discs.

## Disc Operations (continued)

### Changing sound track language

This operation works only on DVDs with multiple soundtrack languages, you can change the language you want while playing a DVD.

- Press **AUDIO** repeatedly to select the available audio languages.

### For VCD – changing the audio channel

- Press **AUDIO** repeatedly to select the available audio channels provided by the disc:  
LEFT VOCAL → RIGHT VOCAL →  
MONO LEFT → MONO RIGHT →  
STEREO

### Switching camera angles

This option is only available with DVDs that contain sequences recorded from different camera angles. This allows you to view the picture from different angles.

- Press **ANGLE** repeatedly to select the available camera angles.

### Playing an MP3/ JPEG disc

This DVD system can playback most of the MP3 and JPEG files recorded on a CD-R/RW disc or commercial CD.

#### Before you start ...

Turn on your TV to the correct Video In channel. See the section on 'Finding the correct viewing channel'.

- 1 Insert a disc.
  - The disc reading time may exceed 30 seconds due to the complexity of the directory/file configuration.
  - The disc menu appears on the TV. If not press **DISC MENU** on the remote control.

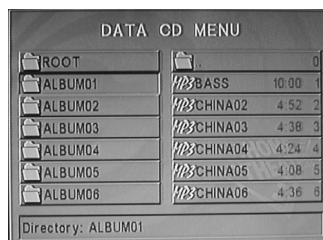

- 2 If the disc main menu contains various folders, use ◀ ▶ ▲ ▼ keys to select a desired folder and press **OK** to open the folder.
  - 3 Use ▲ ▼ keys to select a track/file and press **OK** to start playback.
    - Playback will start from the selected file and continue through to the end of the folder.
- You can also use the **numeric keypad (0-9)** to enter your choice.

**TIPS:** The operating features described here might not be possible for certain discs. Always refer to the instructions supplied with the discs.

## Disc Operations (continued)

During playback, you can;

- Press ◀ / ▶ to playback previous/next track/file in the current folder.
- Press ◀◀ / ▶▶ to fast reverse/forward search for a music track.
- Press **REPEAT** repeatedly to access various play modes.
- 4 To stop playback, press **STOP** ■.

### Zoom picture

- 1 During playback, press **ZOOM** repeatedly to select 'ZOOM ON' or 'ZOOM OFF'.  
→ In 'ZOOM ON' mode, press ▶▶ or ◀◀ to zoom in or zoom out the image.
- 2 Use ◀▶ ▲▼ keys to pan through the zoomed image.

### Rotating/flipping the picture

- During playback, use ◀▶ ▲▼ keys to rotate/flip the picture on the TV.
  - ▲ : flip the picture vertically
  - ▼ : flip the picture horizontally
  - ◀ : rotate the picture anti-clockwise
  - ▶ : rotate the picture clockwise

#### Helpful Hint:

– It may require longer time for the DVD system to display the disc content on the TV due to the large number of songs/pictures compiled into one disc.

## Playing MP3 music and JPEG pictures simultaneously

You can create a musical slide show if the disc contains both the MP3 music and JPEG picture files.

- 1 Insert an MP3 disc that contains music and pictures.
- 2 Select an MP3 track in the menu and press **ANGLE**.  
→ 'MP3 is selected' appears on the TV.
- 3 Use ▲▼ keys to select a picture file, then press **OK**.
- 4 To stop simultaneous playback, press **STOP** ■.  
→ The picture and MP3 music playback will stop.

#### Helpful Hints:

- Due to the recording nature of Digital Audio MP3 (DAM), only digital music will play.
- It is normal to experience an occasional "skip" while listening to your MP3 disc.
- It is normal to experience an occasional pixelation during MP3 playback due to poor clarity of digital contents during internet downloading.
- Only the first session of a multi-session CD will be played back.
- It may not be possible to play certain MP3 or JPEG disc due to the configuration and characteristics of the disc or condition of the record.
- If the disc menu doesn't appear on the screen, press **DISC MENU** to turn on the menu.

**TIPS:** Some discs cannot be played on this player due to the configuration and characteristics of the disc, or due to the condition of recording and authoring software that was used.

# DVD Setup Menu Options

## Using the menu bar

You can continue a number of operations directly via the multiple menu bars on the TV screen without interrupting the disc playback. The exception is when you enter **SETUP** (SETUP MENU), after which the playback will pause.

### IMPORTANT!

- Some operations may be different or restricted, depending on the disc format. Refer to the jacket or case of the disc you are playing.
- Changing the Subtitle Language and Audio Language from the menu bar will only apply to the current disc, it will not change the default preset.

- 1 In 'DISC' mode, press **SETUP** on the remote control.  
→ The menu bar appears across the top of the TV.



- 2 Use **◀▶▲▼** keys to navigate in the menu.  
→ Press **◀▶** to move through the menu bar.  
→ Press **▼** to enter the selection. If there are multiple choices available, press **▼** repeatedly to select.
- 3 Press **SETUP** again to exit the menu.

	<b>SUBTITLE</b> Select a subtitle language that is available on the DVD.
	<b>LANGUAGE</b> DVD: Select an audio soundtrack language that is available on the DVD. VCD: Select an audio channels: LEFT VOCAL, RIGHT VOCAL, MONO LEFT, MONO RIGHT or STEREO.
	<b>SLOW</b> Select a slow playback speed. The volume will be muted. To resume normal playback, press <b>▶II</b> . DVD: SFX2, SFX4, SFX8, SRX2, SRX4, SRX8, PLAY. VCD: SFX1, SFX2, SFX3, PLAY. (SF-Slow Forward, SR-Slow Reverse)
	<b>FAST REVERSE (FR)</b> DVD/MP3: FRX2, FRX4, FRX6, FRX8, PLAY. VCD/CD: FRX1, FRX2, FRX3, FRX4, PLAY. <b>FAST FORWARD (FF)</b> DVD/MP3: FFX2, FFX4, FFX6, FFX8, PLAY. VCD/CD: FFX1, FFX2, FFX3, FFX4, PLAY. Select a search speed (FR-backward, FF-forward). The volume will be muted. To resume normal playback press <b>▶II</b> .
	<b>STATUS</b> Allows viewing of the current status of the disc. The information will vary depending on the disc format.
	Available on DVD only <b>TITLE SEARCH (TITLE: XX:YY)</b> Select a Title for playback to begin. <b>CHAPTER SEARCH (CHAPTER: XX:YY)</b> Select a Chapter for playback to begin. "XX"- Current title/chapter number. "YY"- Total number of title/chapter. Use the numeric keypad (0-9) to change the "XX" number, then press OK.
	<b>TIME SEARCH</b> Use the numeric keypad (0-9) to enter the time (hours, minutes and seconds) at which you want playback to begin (for DVD, CD or VCD with PBC OFF only).
	<b>ZOOM</b> Select an enlarge picture ratio: x1.5, x2 or x3. You can use <b>◀▶▲▼</b> keys to move within the enlarged picture on the TV. To resume normal playback, select 'ZOOM OFF' from the menu.
	<b>ANGLE (for DVD only)</b> Select to view the same scene from different angles if the DVD is recorded with multiple angles.
	<b>STEP</b> Select to advance the still picture one frame forward. To resume normal playback, press <b>▶II</b> .
	<b>PBC ON/OFF (for VCD2.0 with PBC feature)</b> Select between PBC ON and OFF. 'PBC OFF'- the playback will start automatically. 'PBC ON'- the disc menu (if available) will appear on the TV. Use the numeric keypad (0-9) to enter your choice.
	<b>PROGRAM</b> Stop playback, then select this to enter the program menu (see "Programming disc tracks").
	<b>TRIM LEVEL</b> Use this function to adjust the speakers output level.

## DVD Setup Menu Options (continued)

### Accessing the DVD setup menu

This DVD system setup is carried out via the TV, enabling you to customize the DVD system to suit your particular requirements.

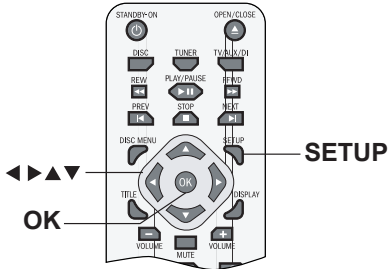

- 1 In 'DISC' mode, press **SETUP** on the remote control.  
→ The setup menu appears.
- 2 Highlight **T** icon and press **▼** to enter the setup menu.  
→ Playback will pause.
- 3 Use **▲ ▼** keys to select one of the setup menu options and press **▶** to enter the menu.
- 4 Use **◀▶▲▼** keys to navigate in the menu and press **OK** to confirm your selection.  
→ Instructions and explanations of the options are provided in the following pages.  
→ If the option in the menu is grayed out, that means the setting is not available or cannot be changed in the current state.
- 5 To exit, press **SETUP**.

#### NOTE:

Some of the features in the Setup Menu are described in "Getting Started" chapter.

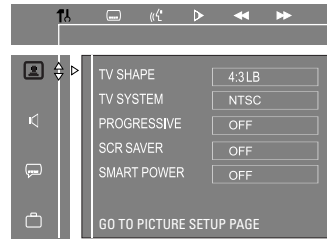

Picture Setup  
see page 33

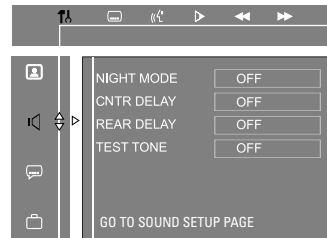

Sound Setup  
see page 34



Language Setup  
see page 20

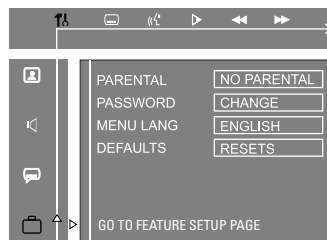

Feature Setup  
see page 35



## DVD Setup Menu Options (continued)

### Picture Setup page (underlined options are the factory default settings)

#### TV SHAPE

The picture shape can be adjusted to fit your TV.

- { 4:3 PS } – For a full-height picture with the sides trimmed.
- { 4:3 LB } – For a 'wide-screen' display with black bars on the top and bottom
- { 16:9 } – For wide-screen TV (frame ratio 16:9).



#### TV SYSTEM

Selects the color system that matches the connected TV. It will enable playback of a different type of disc (PAL or NTSC disc) on this DVD system.

- { AUTO } – For TV that is compatible with both PAL and NTSC.
- { NTSC } – For NTSC-system TV.
- { PAL } – For PAL-system TV.

#### PROGRESSIVE

Before enabling the progressive scan feature, you must ensure that your TV can accept progressive signals and you have connected this DVD system to your TV using the Y Pb Pr jacks.

- { OFF } – Disables the progressive scan mode.
- { ON } – Turns on progressive scan mode.  
Read the instructions on the TV and confirm your action by pressing **OK** on the remote control.

**Note:** For detailed progressive scan setting, see page 23.

#### SCR SAVER

The screen saver prevents damage to the TV screen by avoiding exposure to a static image for too long.

- { ON } – Switches to TV screen saver mode when playback has been stopped or paused for more than 5 minutes.
- { OFF } – Turns off the screen saver function.

#### SMART POWER

This is a power-saving feature. The DVD system will automatically switch to standby mode if you do not press any buttons within 15 minutes after a disc has stopped playing.

- { OFF } – Turns off the smart power function.
- { ON } – Switches to standby mode if no actions are performed within 15 minutes in disc stop mode.

## DVD Setup Menu Options (continued)

### Sound Setup Page (underlined options are the factory default settings)

#### **NIGHT MODE**

This mode optimizes playback of sound at low volume. High volume outputs will be softened and low volume outputs will be enhanced to an audible level. This feature is only applicable for DVD video discs with Dolby Digital mode.

- { OFF } – Turns off night mode feature. Selects this to enjoy the surround sound with its full dynamic range.
- { **ON** } – Turns on night mode.

#### **CNTR DELAY**

Set the delay time in relation to the listening position/distance from the center speaker. Use ◀ ▶ keys to set the delay times (5ms, 3ms, 2ms, 1ms or OFF) and press **OK** to confirm.

#### **REAR DELAY**

Set the delay time in relation to the listening position/distance from the rear speakers. Use ◀ ▶ keys to set the delay times (15ms, 12ms, 9ms, 6ms, 3ms or OFF) and press **OK** to confirm.

**Note:** 1 ms increase/decrease of delay time is equivalent to 30 cm change in distance. Use the longer delay time settings when the rear speakers are closer to the listener than the front speakers.

#### **TEST TONE**

This feature helps you to judge the sound level of each speaker.

- { OFF } – Turns off test tone.
- { **ON** } – Turns on test tone, the test signal will be automatically generated when you set the speakers' channels.

## DVD Setup Menu Options (continued)

### Feature Setup Page (underlined options are the factory default settings)

#### **PARENTAL**

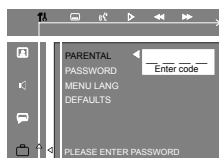

This is to prohibit viewing of discs that had exceeded the limits you set. It works only on the DVDs with parental level assigned to the complete disc or to certain scenes on the disc.

- 1) Highlight { **PARENTAL** } and press ►.
- 2) Use the numeric keypad (0-9) to enter '1234' (default password) when you are asked to enter the four-digit password. You will have to enter the same code again to reconfirm.
- 3) Select a rating level and press **OK**.

#### **Notes:**

- To change the password, see 'PASSWORD'.
- DVDs that are rated higher than the level you selected will not be played unless you enter the same four-digit password. To disable Parental Control and have all discs play, choose { **NO PARENTAL** }.
- Some DVDs are not encoded with a rating though the movie rating may be printed on the Disc cover. The rating level feature does not prohibit playback of such Discs. VCD, SVCD, CD have no level indication, so parental control has no effect on these type of discs.

#### **PASSWORD**

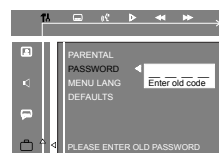

The password is used for the Parental Control. Enter your four-digit password to play a prohibited disc or when prompted for a password. The default password is '1234'. To change the password:

- 1) Highlight { **PASSWORD** } and press ►.
- 2) Use the numeric keypad (0-9) to enter your existing four-digit password at "Enter old code".

**Note:** When doing this for the first time, key in '1234'. If you forget your existing password, press ■ 4 times to restore to the default password '1234'.

- 3) Enter the new four-digit password at { Enter new code }.
- 4) Enter the same new four-digit password again at { Confirm code }.

#### **MENU LANG**

Select the menu language for this DVD system's on-screen display. Default language is English.

#### **DEFAULT**

This feature enables you to reset all the setup menu options and your personal settings to factory defaults, except your password and parental setting. Press ► to select { **RESET** }.



## Tuner Operations (continued)

### Using automatic preset

Use automatic presetting to store or reinstall all the preset radio stations.

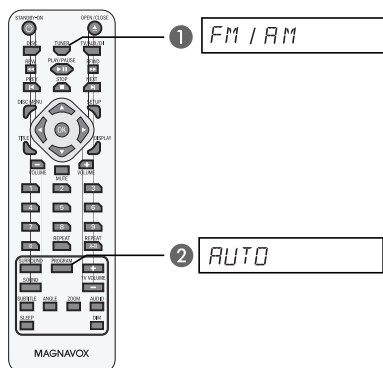

- 1 Press **TUNER** to select “FM” or “AM” band.
- 2 Press and hold **PROGRAM** until “AUTO” appears on the display panel.  
→ All previously stored radio stations will be replaced.

### Using manual preset

Use manual presetting to store your favorite radio stations.

- 1 Tune to your desired radio station (see ‘Tuning to radio stations’).
- 2 Press **PROGRAM**.
- 3 Use ◀▶ keys to select a preset number that you want to store the current radio station (or use the numeric keypad on the remote control to enter your choice).
- 4 Press **PROGRAM** to store.

### Selecting a preset radio station

- 1 Press **TUNER** to select “FM” or “AM” band.
- 2 Use ◀▶ or ◀ / ▶ keys to select a preset radio stations.  
→ The preset number followed by waveband and radio frequency will appear on the display panel.

### Deleting a preset radio station

- 1 In tuner mode, use ◀▶ or ◀ / ▶ keys to select a preset radio station.
- 2 Press ■.  
→ “DELETED” appears.  
→ The current preset radio station will be deleted.

### Changing tuning grid

(not available for all versions)

In some countries, the frequency step between adjacent channels in the AM/FM band is 9 kHz/ 50 kHz (10 kHz/ 100 kHz in some areas).

#### IMPORTANT!

**Changing the tuning grid will erase all previously stored preset radio stations.**

- In tuner mode, press and hold ▶|| for more than 5 seconds, the display will show “9/50KHZ” or “10/100KHZ”.

## Sound and Volume Controls

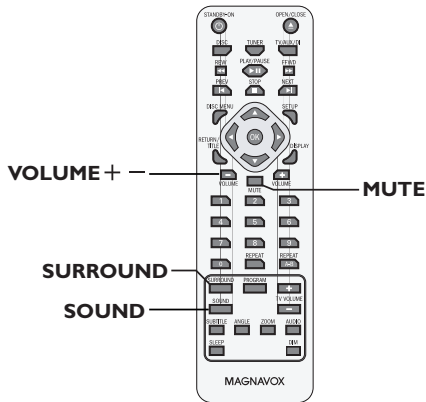

### Selecting surround sound

- Press **SURROUND** to select multi-channel surround or Stereo.
  - The availability of the various surround sound modes depends on the sound available on the disc.
  - The center and rear speakers operate only in multi-channel surround mode.
  - The available output modes for Multi-channel include: Dolby Digital, Dolby Pro Logic or Dolby Pro Logic II surround.
  - Stereo broadcasts or recordings will produce some surround channel effects when played in a surround mode. However, mono (single channel sound) sources will not produce any sound from the rear speakers.
  - During playback of DTS audio track, sound will be muted even though Video is playback, “Press AUDIO to select other audio track.” will appear on TV. Follow the instructions to get sound output.

### Selecting digital sound effects

Select a preset digital sound effect that matches your disc’s content or that optimizes the sound of the musical style you are playing.

- Press **SOUND** to select the available sound effect.

When playing movie discs or in TV mode, you can select:

CONCERT, DRAMA, ACTION or SCI-FI.

When playing music discs or while in TUNER or AUX/DI mode, you can select: CLASSIC, JAZZ, ROCK or DIGITAL.

*Helpful Hint:*

– For flat sound output, select *CONCERT* or *CLASSIC*.

### Volume control

- Press **VOLUME + / -** on the set or remote control to increase or decrease the volume level.
  - “VOL MIN” is the minimum volume level and “VOL MAX” is the maximum volume level.

**To turn off the volume temporarily**

- Press **MUTE** on the remote control.
  - Playback will continue without sound and “MUTE” appears.
  - To restore the volume, press **MUTE** again, or increase the volume level.

## Other Features

### Controlling 'PHILIPS' TV with the remote control

This DVD system's remote control enables you to control the basic functions of your 'PHILIPS' brand TV.

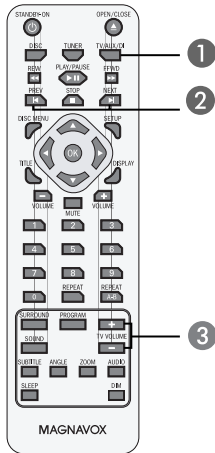

- 1 Press **SOURCE** repeatedly until "TV" appears on the display panel (or press **TV/AUX/DI** on the remote control repeatedly).
- 2 Use **◀ / ▶** keys or the **numeric keypad (0-9)** to select the TV's channel.
- 3 Press **TV VOLUME + / -** to adjust the TV's volume level.

### Dimming system's display screen

- In any active mode, press **DIM** on the remote control to select desired brightness: HIGH, MID or LOW. HIGH is default setting.

### Setting the sleep timer

The sleep timer enables the system to switch to standby mode automatically at a preset time.

- Press **SLEEP** repeatedly until it reaches the desired preset turn-off time.  
→ The selections are as follows (time in minutes).  
15 → 30 → 45 → 60 → OFF → 15...  
→ Before the system switches to standby mode, a countdown of 10 seconds is displayed.

#### To check or change the setting

- Press **SLEEP** once to show the remaining time before switching off. If you continue pressing the **SLEEP** button, the next sleep timer option will appear.

#### To cancel the sleep timer

- Press **SLEEP** repeatedly until "OFF" appears or press the **STANDBY ON**.

# Troubleshooting

## WARNING

Under no circumstances should you try to repair the system yourself, as this will invalidate the warranty. Do not open the system as there is a risk of electric shock.

If a fault occurs, first check the points listed below before taking the system for repair. If you are unable to solve a problem by following these instructions, consult your dealer for help.

Problem (General)	Solution
<b>No power.</b>	<ul style="list-style-type: none"> <li>– Check if the AC power cord is properly connected.</li> <li>– Press the  (STANDBY ON) to turn on the power.</li> </ul>
<b>No picture.</b>	<ul style="list-style-type: none"> <li>– Refer to your TV's manual for correct Video In channel selection. Change the TV channel until you see the DVD screen.</li> <li>– Press the DISC button to select disc mode.</li> <li>– If this happens when you are turning on the progressive scan feature, wait for 15 seconds for the auto recovery.</li> </ul>
<b>Completely distorted picture or black/white picture.</b>	<ul style="list-style-type: none"> <li>– If this happens when you are changing the setting of the 'TV SYSTEM', wait for 15 seconds for the auto recovery.</li> <li>– Check the video connection.</li> <li>– Sometimes a small amount of picture distortion may appear. This is not a malfunction.</li> <li>– Clean the disc.</li> </ul>
<b>No sound or distorted sound.</b>	<ul style="list-style-type: none"> <li>– Adjust the volume.</li> <li>– Check the speaker connections and settings.</li> <li>– Make sure that the audio cables are connected and press the SOURCE button to select the correct input source (for example, TUNER or TV/AUX/DI) to choose the device that you want to hear through the DVD system.</li> <li>– When playback of DTS track, press <b>AUDIO</b> to select other audio track.</li> </ul>
<b>There is no sound from the center and rear speakers.</b>	<ul style="list-style-type: none"> <li>– Make sure that the center and rear speakers are connected correctly.</li> <li>– Press the SURROUND button to select a correct surround sound setting.</li> <li>– Make sure that the source you are playing is recorded or broadcast in surround sound (Dolby Digital, etc.).</li> </ul>



## Troubleshooting (continued)

Problem (Playback)	Solution
<b>The remote control does not function properly.</b>	<ul style="list-style-type: none"><li>– Select the source you want to play (for example, DISC or TUNER) before pressing the function button (▶, ◀◀ / ▶▶).</li><li>– Reduce the distance between the remote control and the system.</li><li>– Replace the batteries with new ones.</li><li>– Point the remote control directly toward the IR sensor.</li><li>– Check that the batteries are loaded correctly.</li></ul>
<b>The DVD system does not start playback.</b>	<ul style="list-style-type: none"><li>– Insert a readable disc with the playback side facing down. The DVD+R/CD-R must be finalized.</li><li>– Check the disc type, color system (PAL or NTSC) and region code.</li><li>– Check for any scratches or smudges on the disc.</li><li>– Press SETUP to turn off the system setup menu screen.</li><li>– You may need to enter the password in order to unlock the disc for playback.</li><li>– Moisture may have condensed inside the system. Remove the disc and leave the system turned on for about an hour.</li></ul>
<b>The aspect ratio of the screen cannot be changed even though you have set the TV display.</b>	<ul style="list-style-type: none"><li>– The aspect ratio is fixed on the DVD disc.</li><li>– Depending on the TV, it may not be possible to change the aspect ratio.</li></ul>
<b>Cannot activate some features such as Angles, Subtitles, or multi-language Audio.</b>	<ul style="list-style-type: none"><li>– The features may not be available on the DVD.</li><li>– Changing the language for the sound or subtitle is prohibited on this DVD.</li></ul>
<b>Not able to select some items in the setup/system menu.</b>	<ul style="list-style-type: none"><li>– Press STOP button twice before selecting the system setup menu.</li><li>– Depending on the disc availability, some menu items cannot be selected.</li></ul>
<b>Radio reception is poor.</b>	<ul style="list-style-type: none"><li>– If the signal is too weak, adjust the antenna or connect an external antenna for better reception.</li><li>– Increase the distance between the system and your TV or VCR.</li><li>– Tune in to the correct frequency.</li><li>– Place the antenna further away from any equipment that may be causing the interference.</li></ul>
<b>The DVD system does not work.</b>	<ul style="list-style-type: none"><li>– Disconnect the power cord from the power outlet for a few minutes. Reconnect the power cord and try to operate again as usual.</li></ul>

## Glossary

**Analog:** Sound that has not been turned into numbers. Analog sound varies, while digital sound has specific numerical values. These jacks send audio through two channels, the left and right.

**Aspect ratio:** The ratio of vertical and horizontal sizes of a displayed image. The horizontal vs. vertical ratio of conventional TVs is 4:3, and that of wide-screens is 16:9.

**Bit Rate:** The amount of data used to hold a given length of music; measured in kilobits per second, or kbps. Or, the speed at which you record. Generally, the higher the bit rate, or the higher the recording speed, the better the sound quality. However, higher bit rates use more space on a disc.

**Chapter:** Sections of a picture or a music piece on a DVD that are smaller than titles. A title is composed of several chapters. Each chapter is assigned a chapter number enabling you to locate the chapter you want.

**Disc menu:** A screen display prepared for allowing a selection of images, sounds, subtitles, multi-angles, etc to be recorded on a DVD.

**Dolby Digital:** A surround sound system developed by Dolby Laboratories containing up to six channels of digital audio (front left and right, surround left and right, center and subwoofer).

**Dolby Surround Pro Logic II:** It is an improved matrix decoding technology that provides better spatiality and directionality on Dolby Surround program material, provides a convincing three dimensional sound field on conventional stereo music recordings and is ideally suited to bring the surround experience to automotive sound. While conventional surround programming is fully compatible with Dolby Surround Pro Logic II decoders, sound tracks will be able to be encoded specifically to take full advantage of Pro Logic II playback, including separate left and right surround channels. (Such material is also compatible with conventional Pro Logic decoders).

**JPEG:** A very common digital still picture format. A still picture data compression system proposed by the Joint Photographic Expert Group, which features a small decrease in image quality in spite of its high compression ratio.

**MP3:** A file format with a sound data compression system. "MP3" is the abbreviation of Motion Picture Experts Group 1 (or MPEG-1) Audio Layer3. By using the MP3 format, one CD-R or CD-RW can contain about 10 times more data than a regular CD.

**Multi-channel:** DVDs are formatted to have each sound track constitute one sound field. Multi-channel refers to a structure of sound tracks having three or more channels.

**Playback control (PBC):** Refers to the signal recorded on video CDs or SVCDs for controlling playback. By using menu screens recorded on a Video CD or SVCD that supports PBC, you can enjoy interactive playback and searching.

**Region code:** A system allowing discs to be played only in the region designated. This unit will only play discs that have compatible region codes. You can find the region code of your unit by looking at the product label. Some discs are compatible with more than one region (or ALL regions).

**Surround:** A system for creating realistic three dimensional sound fields full of realism by arranging multiple speakers around the listener.

**Title:** The longest section of a movie or music feature on DVD. Each title is assigned a title number, enabling you to locate the title you want.

**VIDEO OUT jack:** Yellow jack on the back of the DVD system that sends the DVD picture video to a TV.

# Specifications

## AMPLIFIER

Output power: 100 W  
- Front: 15 W / channel  
- Rear: 15 W / channel  
- Center: 15 W RMS  
- Subwoofer: 25 W RMS  
Frequency Response: 20 Hz – 20 kHz / -3 dB  
Signal-to-Noise Ratio: > 60 dB (CCIR)  
Input Sensitivity  
- AUX In: 500 mV

## TUNER

Tuning Range: FM 87.5–108 MHz  
(50/100 kHz)  
AM 531–1602 kHz (9 kHz)  
AM 530–1710 kHz (10kHz)

26 dB Quieting  
Sensitivity: FM22dBf  
AM5000 $\mu$ V/m

IF Rejection Ratio: FM 60 dB AM 24 dB  
Signal-to-Noise Ratio: FM 50 dB, AM 30 dB  
AM Suppression Ratio: FM 30 dB  
Harmonic Distortion: FM Mono 3%  
FM Stereo 3%  
AM 5%

Frequency Response: FM 180 Hz–10 kHz  
Stereo Separation: FM 26 dB (1 kHz)  
Stereo Threshold: FM 23.5 dB

## DISC SECTION

Laser Type: Semiconductor  
Disc Diameter: 12cm / 8cm  
Video DAC: 10 Bits  
Signal System: PAL / NTSC  
Video Format: 4:3 / 16:9  
Video S/N: 56 dB (minimum)  
Composite Video  
Output: 1.0 Vp-p, 75 $\Omega$   
Audio DAC: 24 Bits / 96 kHz  
Frequency Response: 4 Hz–20 kHz (44.1 kHz)  
4 Hz–22 kHz (48 kHz)

## MAIN UNIT

Power Supply Rating: 110–127 V / 220–240 V;  
50-60 Hz  
Power Consumption: 35 W  
Dimensions: 360 x 48 x 339 (mm)  
(w x h x d)  
Weight: 2.18 kg

## SPEAKERS

### FRONT and REAR speakers

System: 1-way, closed box system  
Impedance: 4  $\Omega$   
Speaker drivers: 3" full range  
Frequency response: 150 Hz – 20 kHz  
Dimensions: 100 x 95 x 83 (mm)  
(w x h x d)  
Weight: 0.52 kg/each

### Center speaker

System: 1-way, closed box system  
Impedance: 4  $\Omega$   
Speaker drivers: 3" full range  
Frequency response: 150 Hz – 20 kHz  
Dimensions: 100 x 95 x 83 (mm)  
(w x h x d)  
Weight: 0.52 kg

### PASSIVE SUBWOOFER

Impedance: 8  $\Omega$   
Speaker drivers: 6.5" high efficiency woofer  
Frequency response: 40 Hz – 150 Hz  
Dimensions: 130 x 328 x 350 (mm)  
(w x h x d)  
Weight: 3.38 kg

Specifications subject to change without prior notice.