

2

Using your Kenwood Audio/Video System

Spectrum 1050 AV



KENWOOD

Contents

Contents	3	Using the power amplifier	20
Welcome	5	The front panel controls	20
Using the integrated amplifier	6	Selecting speakers	22
The front panel controls and display	6	To use the main set of speakers	22
Using the remote	8	To use a second set of speakers	22
A few tips	8	Adjusting the subwoofer volume	23
Loading and replacing the batteries	10	Using the tuner	24
Programming the remote for your video components	11	The front panel controls and display	24
Controlling your video components	12	Tuning stations automatically	26
The basic audio functions	13	Tuning stations manually	26
Selecting the input source	13	Storing preset stations	27
Adjusting the volume	14	Tuning preset stations	28
Adjusting the bass and treble	15	Scrolling through preset stations	29
Muting the sound	15	Using the CD player	30
Making the sound fuller at low volumes	16	The front panel controls and display	30
Bypassing tone controls and surround circuitry	16	Before using your CD player	32
Activating the speakers	17	Displaying CD time information	33
Adjusting the speaker balance	17	Loading CDs	33
Using headphones	18	Changing CDs	33
About the audio modes	19	During play	33
Dolby Pro Logic	19	When the player is stopped	33
Dolby 3 Stereo	19	Playing CDs	34
Bypass	19	From the beginning	34
Selecting an audio mode	19	From a specific track	35
		Playing a combination of tracks	36
		Programming tracks	36
		To check a program	37
		To resume normal play	37
		To cancel a program and stop play	37
		Adding a track to a program	37
		Changing a track in a program	37
		Clearing a track in a program	37
		Clearing a whole program	37

Playing CDs over (repeat play)	38	Set-up codes for video components	59
Repeating a single CD	38	VCR	59
Repeating all loaded CDs	38	Laser disc player	60
Repeating programmed tracks	38	TV	60
To stop repeat play	38	Cable box	61
Playing tracks in random order (random play)	39	Specifications	63
To select another track during random play	39	Integrated amplifier (KA-996)	63
To cancel random play	39	Power amplifier (KM-996)	63
Using a timer to play CDs	39	Tuner (KT-596)	64
Using the cassette deck	40	CD player (DP-R896)	64
The front panel controls and display	40	Cassette deck (KX-W896)	65
Before using your cassette deck	42	Speakers	65
Maintaining your cassette deck	42		
Listening to tapes	43		
Playing a single tape	43		
Fast-winding tapes	44		
Playing tapes in both cassette wells (relay play)	44		
Finding and playing a specific track (DPSS)	45		
Repeating tracks	45		
Recording tapes	46		
Setting the recording level and balance	46		
Recording a tape	47		
Recording from a CD (with automatic recording-level set)	48		
Recording from a CD (with automatic start and stop)	49		
Creating custom tapes from CDs	50		
Using a timer to record from the tuner	52		
Recording from records	52		
Copying (dubbing) a tape	53		
Troubleshooting	55		
Remote	55		
Integrated amplifier	55		
Power amplifier	56		
Tuner	56		
CD player	57		
Cassette deck	57		

Welcome

Now that you've set up your Spectrum system, the real fun begins! Operating your system is easy, if you follow the step-by-step instructions in this manual. Spend a little time with the manual before you jump in, so you become familiar with the many capabilities of your system. Then put up your feet, sit back and enjoy the fabulous sound of your Spectrum system!

Using the integrated amplifier

The front panel controls and display

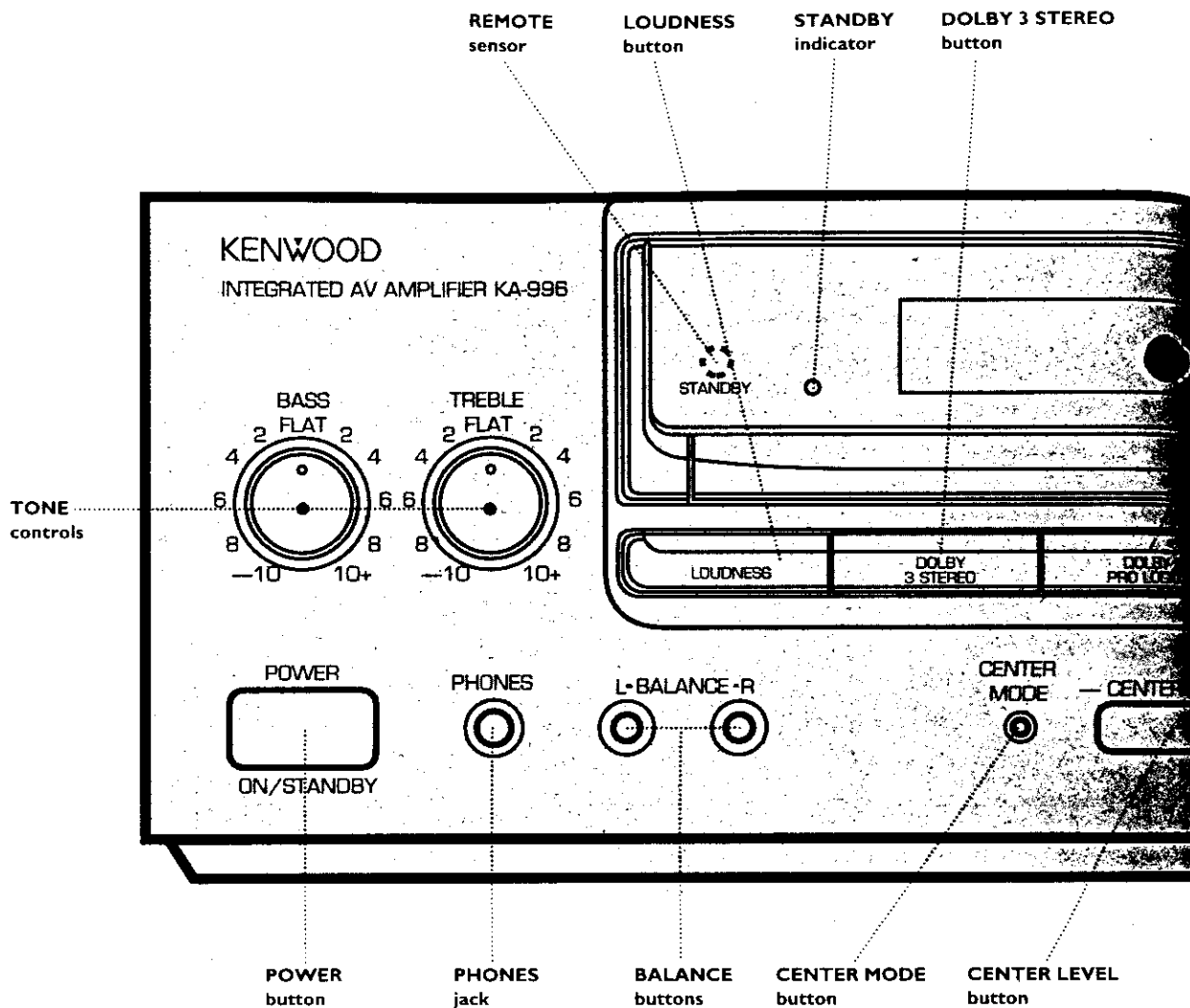

POWER button

Press to turn the system and video components ON or OFF

COMPONENT buttons

Use to choose the audio or video component being controlled

- Press AUDIO to cycle among AUDIO, TUNER, CD, TAPE A, and TAPE B
- Press VCR to select either VCR 1 or VCR 2
- Press LD to select the laser disc player
- Press TV/CABLE to select either television or cable box

ENTER button

Use to enter information (such as setup codes or radio station call numbers)

DISPLAY button

Press to show what component is currently being controlled by the remote

PLAY/REVERSE buttons

- When using a laser disc player or VCR, press ► to play
- When using a cassette deck, press ► to play and reverse
- When using a TV or cable box, press ► to control the TV's volume
- When using a CD player, press ► to play and pause
- When calibrating channel levels, press ► to adjust the center channel

FAST-FORWARD/REWIND

- When using a VCR or cassette player, press ◀ or ▶ to fast-forward or rewind
- When using a CD player, press ◀ or ▶ to skip 1 track forward or backward
- When using a laser disc player, press ◀ or ▶ to scan forward or backward
- When calibrating channel levels, press ► to adjust the surround channel

MUTE button

Press to mute the sound, then press again to restore the sound

INPUT buttons

Press ▲ or ▼ to scroll through the selection of input sources

VOLUME buttons

Press ▲ or ▼ to increase or decrease the volume

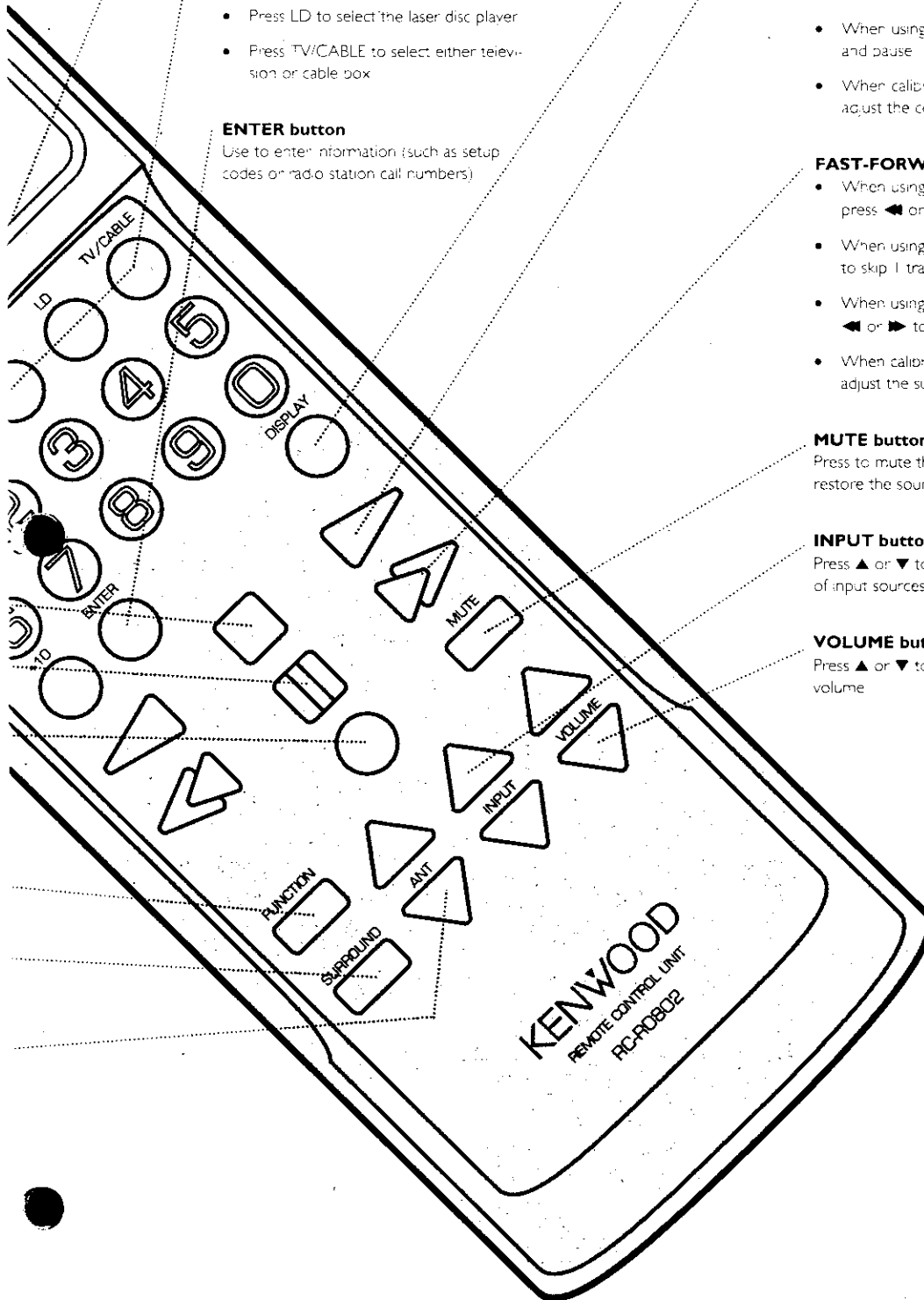

Loading and replacing the batteries

If the display on the remote doesn't light when you press a button, you need new batteries. We recommend replacing both batteries at the same time for longer battery life.

Important:

When you remove the batteries, you have about 3 minutes to replace them without losing the pre-programmed codes you've set up to control video components. If you leave your remote without batteries for longer than 3 minutes, you'll need to reprogram any functions you've programmed into it. Don't worry, you'll never lose the functions that come programmed into the remote at the factory.

- 1 Remove the cover by pressing down on the ridged area and sliding it off in the direction of the arrow.
- 2 Insert 2 AA-size alkaline batteries (be sure to pay attention to the (+) and (-) signs when you're inserting the batteries).
- 3 Close the cover.

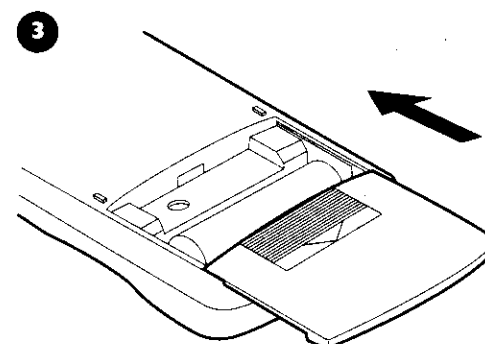
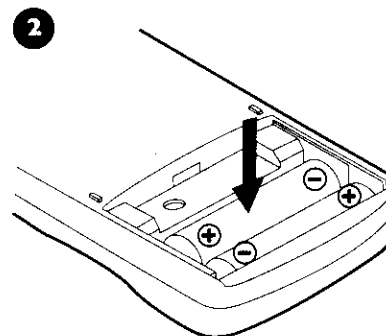
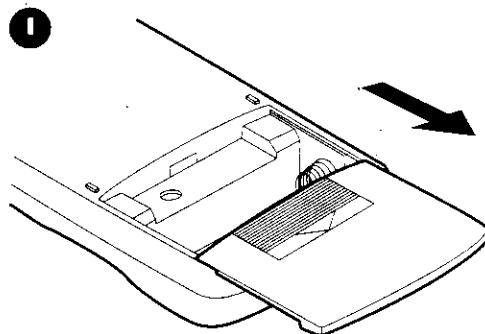

Programming the remote for your video components

Using your remote, you can enter a code to operate video components (TVs, VCRs, laser disc players, and cable TV boxes) from many manufacturers.

Important:

Read these instructions completely before starting so you know what to do next. You must finish steps 3, 4, and 5 within 5 seconds each.

- 1 Look at the list of manufacturer's setup codes on page 60 to find the code for your video component.
- 2 Press the appropriate component button. For example, press the VCR button to select VCR 1, or press it again to select VCR 2.
- 3 Press the ENTER button within 5 seconds. The display shows 'SET'.
- 4 Using the number buttons, enter the setup code within 5 seconds. For example, to set up a VCR from Kenwood, enter 056, 061, or 082. If you make a mistake, wait until the display clears and go back to step 2.
- 5 Press the ENTER button within 5 seconds. If the setup worked, the display shows OK. If the setup did not work, the display shows NG. If you see NG, go back to step 4 within 5 seconds to try re-entering the setup code.

For example

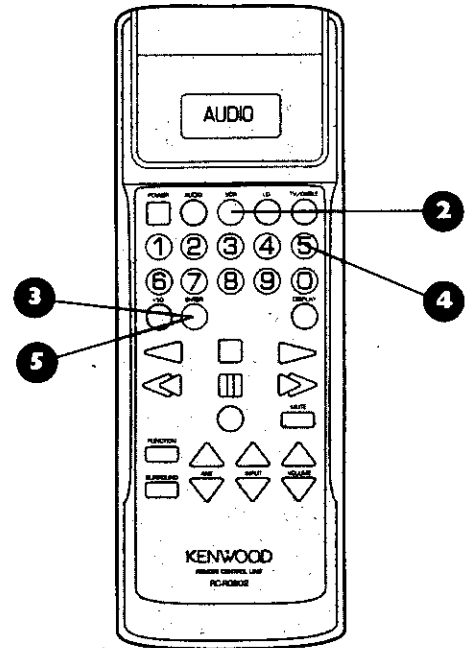

Controlling your video components

Once you've programmed the setup codes, your Spectrum system can control your video components using the remote.

To turn a component ON

- 1 Press the appropriate component button. For example, press the VCR button to select VCR 1, or press it again to select VCR 2.
- 2 Point the remote toward the component, and press the POWER button.
- 3 Press the button for the function you want.

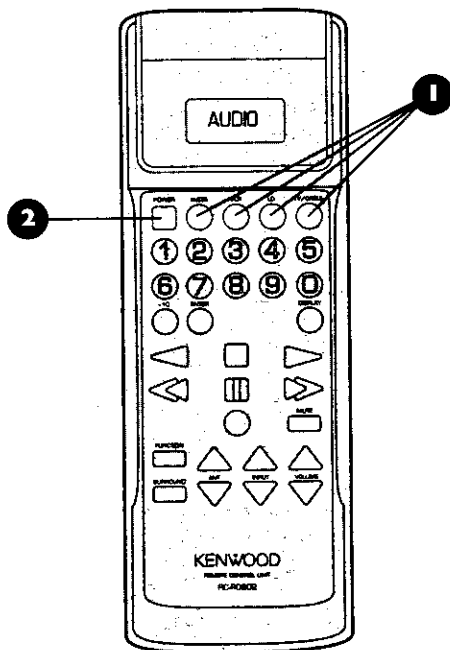

To turn a component OFF

- 1 Press the appropriate component button. For example, press the VCR button to select VCR 1, or press it again to select VCR 2.
- 2 Press the POWER button.

Controlling a VCR

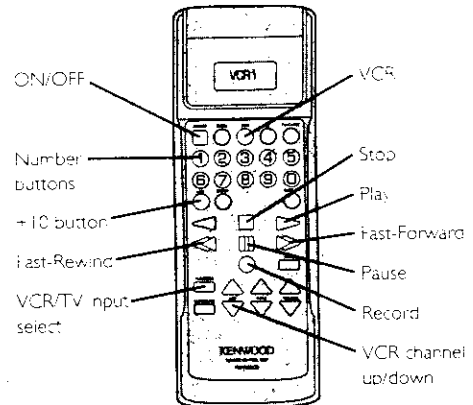

Controlling a laser disc player

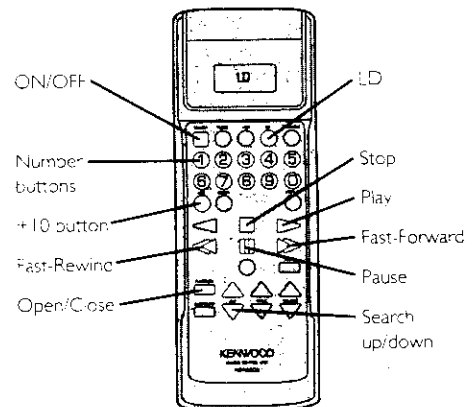

Controlling a TV or cable box

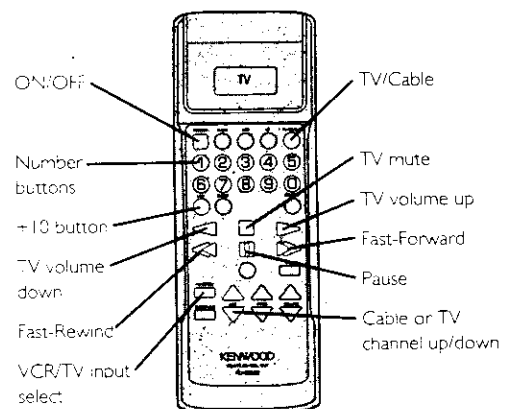

The basic audio functions

Selecting the input source

You can play audio from as many as 6 different sources, including:

- TUNER
- CD
- PHONO
- TAPE 1
- VIDEO 1
- VIDEO 2

Selecting from the front panel

Rotate the INPUT SELECTOR knob until you see the input source you want on the display.

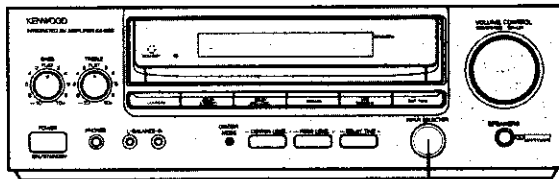

Selecting from the remote

Press the INPUT buttons until you see the input source you want on the display.

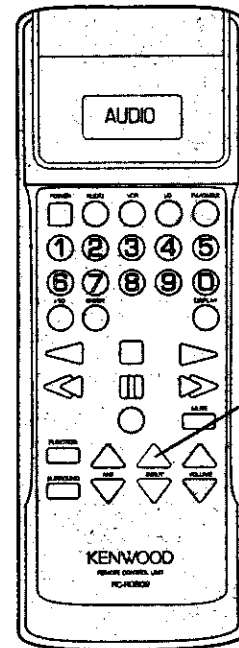

Adjusting the volume

You can increase or decrease the volume level in 1 decibel (dB) increments.

The amplifier's display shows the decibel level change.

Adjusting from the front panel

Turn the VOLUME knob to the right to increase the volume. Turn the knob to the left to decrease it.

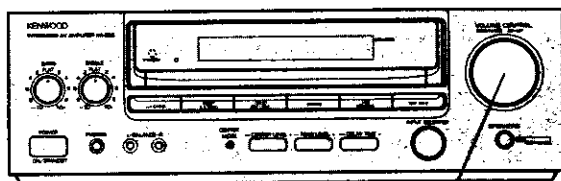

Adjusting from the remote

Press the VOLUME buttons to increase or decrease the volume level.

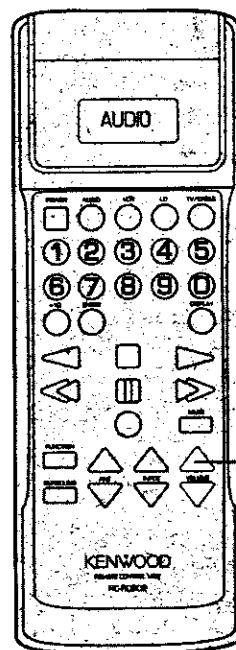

Adjusting the bass and treble

You can increase or decrease the bass or treble to personalize the sound.

Turn the BASS and TREBLE controls to the right to increase them. Turn the controls to the left to decrease them.

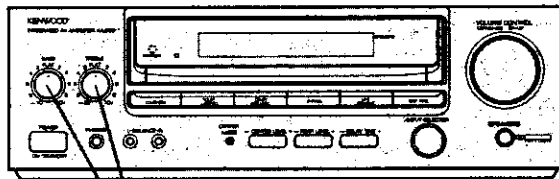

Muting the sound

You can quickly turn OFF the sound (when the phone rings, for example), and turn it ON again without stopping play.

Press the MUTE button to turn the sound OFF. Press it again to turn the sound ON.

The MUTE light on the display flashes while MUTE is ON.

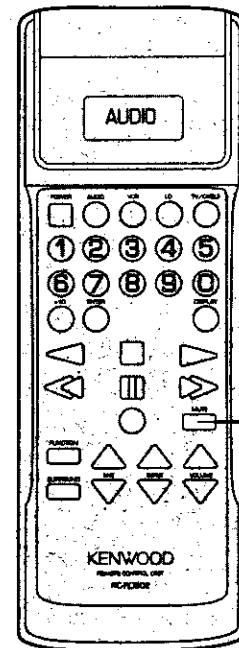

Making the sound fuller at low volumes

You can adjust the bass when you're listening at low volumes. This compensates for the fact that your hearing is less sensitive to bass at these volumes.

Press the LOUDNESS button to increase the bass. Press it again to restore normal tonal balance.

The LOUDNESS light on the display turns ON when LOUDNESS is ON and goes OFF when LOUDNESS is OFF.

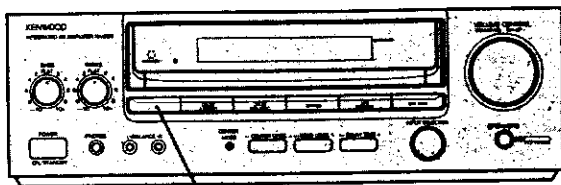

Bypassing tone controls and surround circuitry

You can bypass the tone controls and the surround sound circuitry to enjoy your music with purer sound quality.

Press the LINE STRAIGHT button to bypass the tone controls and surround circuitry. Press it again to cancel.

The LINE STRAIGHT light on the display illuminates when LINE STRAIGHT is ON and goes OFF when LINE STRAIGHT is OFF.

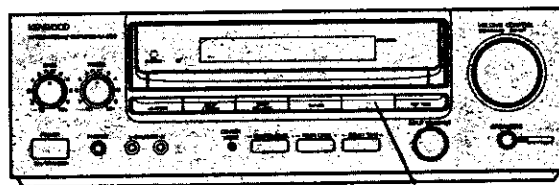

Activating the speakers

You can turn all of the speakers ON or OFF (for example, to use headphones) with the SPEAKERS button.

- 1 Press the SPEAKERS button (while they are off) to turn the speakers ON.
- 2 Press the SPEAKERS button again to turn the speakers OFF.

The SPEAKERS light on the display turns ON when the speakers are ON, and it goes OFF when the speakers are OFF.

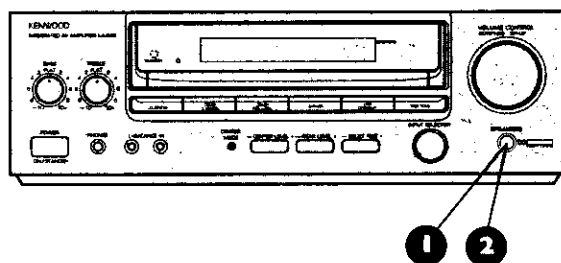

Adjusting the speaker balance

You can adjust the volume balance between the left and right speakers.

- 1 Press the L BALANCE button to decrease the right speaker volume and maintain the left.
- 2 Press the R BALANCE button to decrease the left speaker volume and maintain the right.

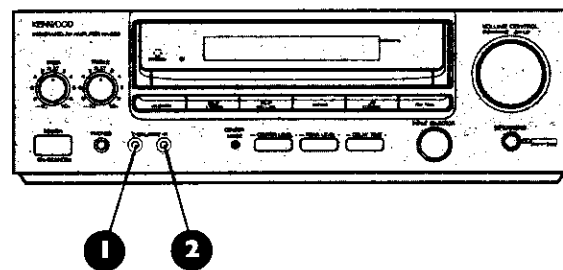

While you're adjusting the balance, the display shows the relative volume between the left and right speakers.

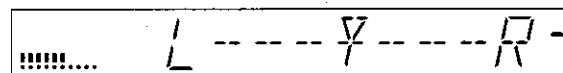

Using headphones

You can use headphones to listen to music or the soundtrack of a film or TV in private.

- 1 Turn the speakers OFF.
- 2 Insert the headphone plug into the HEADPHONE jack, and then put them on.

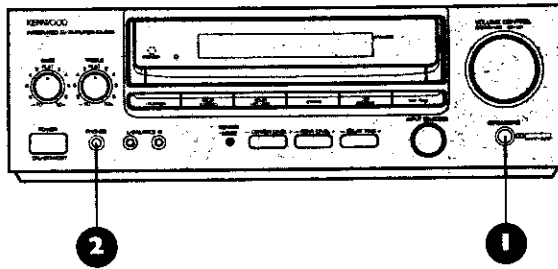

Important:

There are a few things to keep in mind when using headphones:

- Turn the volume down before switching the speakers back on.
- You can use your headphones with the speakers on, but be careful. The volume through the headphones is usually lower than the volume through speakers. When you turn up the volume for the headphones, be careful not to turn it up so loud you damage your speakers.

About the audio modes

Using one of the system's audio modes, you'll get optimum sound from your system, whether you're playing music or watching a movie.

Dolby Pro Logic

Use it for movies, music videos, stereo TV broadcasts, and audio CDs recorded in Dolby Surround, and some older films with the Dolby Stereo logo. Dolby Pro Logic is designed to recreate the surround sound from films, music videos, and stereo TV broadcasts encoded in Dolby Surround. It'll bring out the full effect of Dolby Surround-encoded audio CDs and even do a great job with standard CDs.

Dolby 3 Stereo

Use it for movies, music videos, stereo TV broadcasts, and audio CDs recorded in Dolby Surround, and some older films with the Dolby Stereo logo. Dolby 3 Stereo takes Dolby Surround-encoded movies and decodes the sound for a system without surround speakers.

Bypass

Use it for audio CDs not recorded in Dolby Surround, and tapes, records, and TV broadcasts not encoded in Dolby Surround. Bypass mode uses the left and right front speakers and the subwoofer for standard music play. It's called 'bypass' because it bypasses the surround processing.

Selecting an audio mode

Selecting from the front panel

Select the appropriate button for DOLBY PRO LOGIC, DOLBY 3 STEREO, or BYPASS.

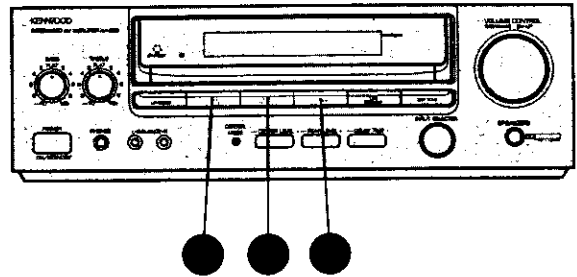

Selecting from the remote

Press the SURROUND button to scroll through DOLBY PRO LOGIC, DOLBY 3 STEREO, and BYPASS.

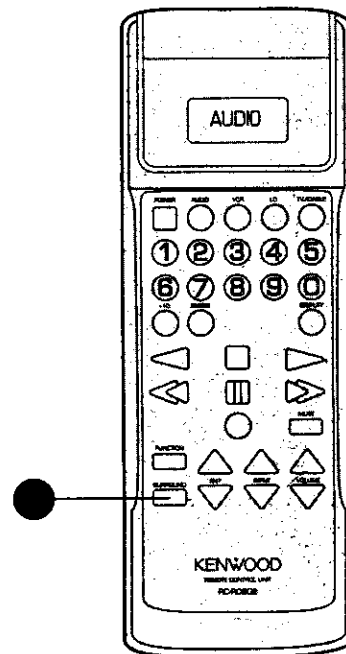

Using the power amplifier

The front panel controls

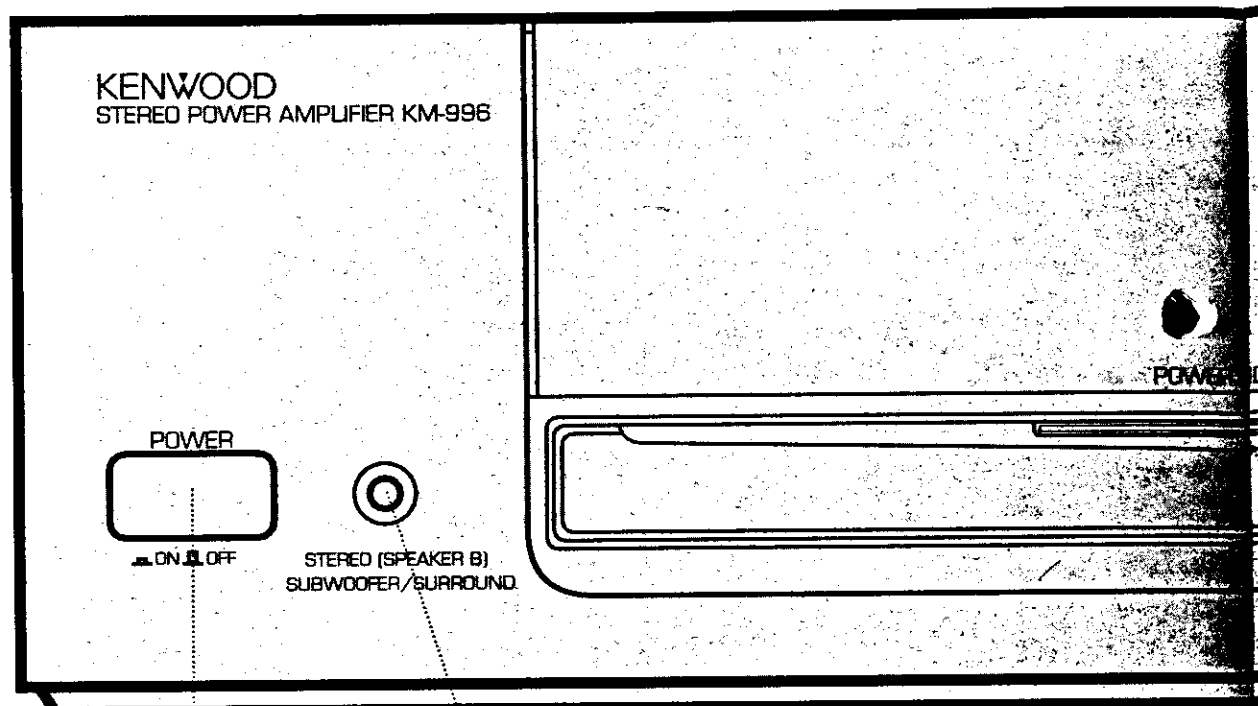

POWER button

SUBWOOFER/SURROUND/STEREO selector



ATOR

POWER indicator

Selecting speakers

You can set the amplifier to power your subwoofer and center speaker (the integrated amplifier powers the left, right and surround speakers), or to power an optional second set of left and right stereo speakers.

To use the main set of speakers

Press the selector button so it's OUT.

The power amplifier normally powers the system's center channel speaker and subwoofer.

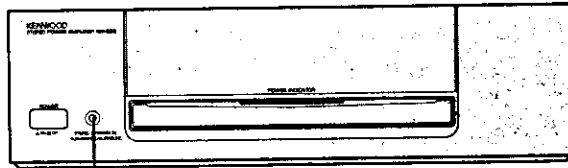

Button out

To use a second set of speakers

Press the selector button so it's IN.

The optional second set of speakers and the system's left and right speakers operate, but the center speaker and subwoofer do not. To turn the left and right speakers OFF, read 'Activating the speakers' on page 17.



Button in

Adjusting the subwoofer volume

You can adjust the volume of the subwoofer to blend the bass with the rest of the system to your liking.

The subwoofer volume knob is located on the rear panel of the power amplifier.

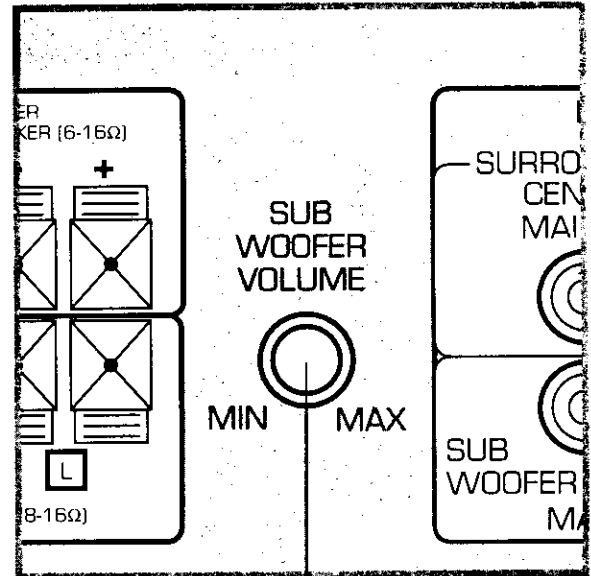

Power amplifier (KM-996)
rear panel detail

Using the tuner

The front panel controls and display



POWER button

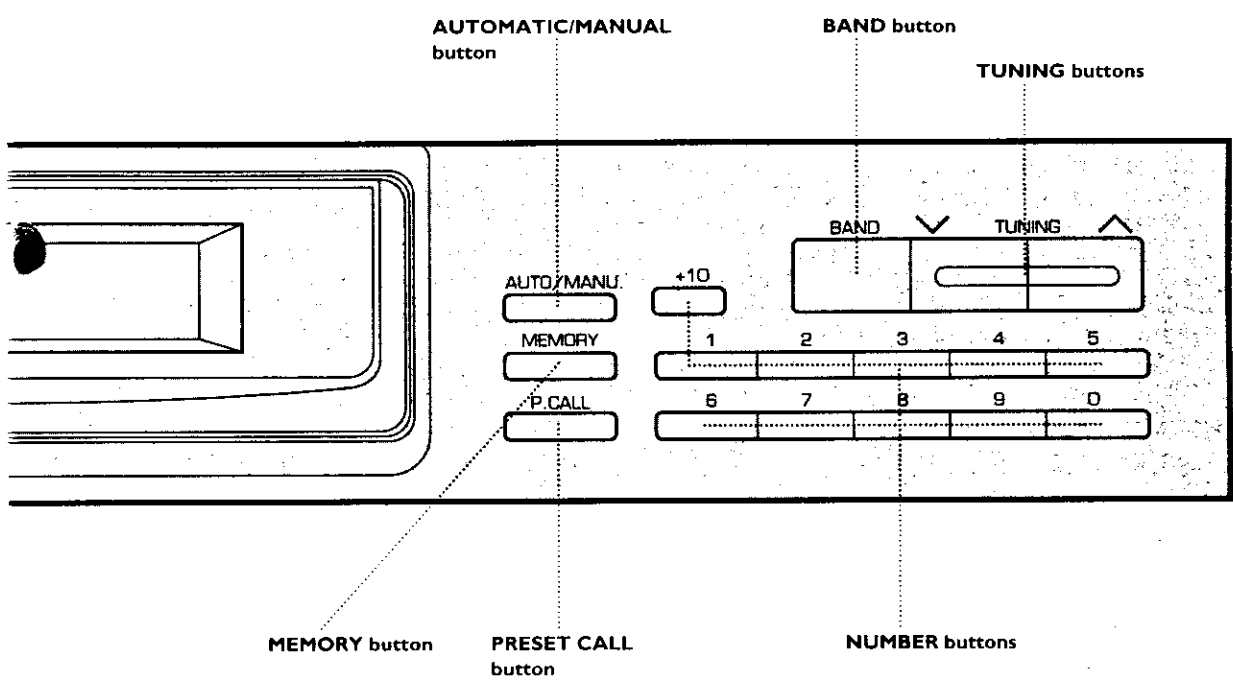
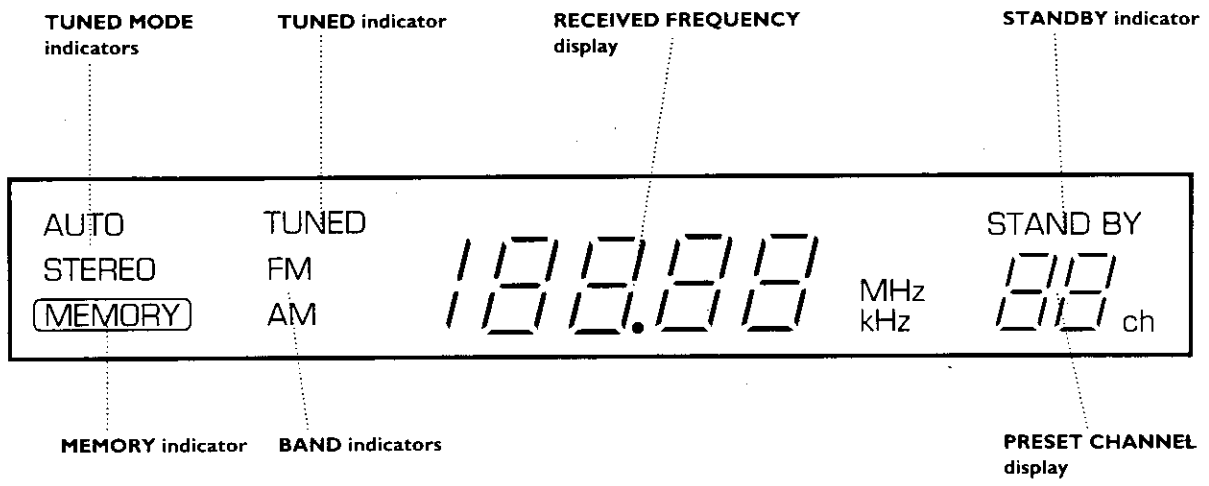

Tuning stations automatically

You can automatically find the strongest radio station signals.

- 1 Select the TUNER input.
- 2 Press the BAND button to select FM or AM.
- 3 Press the AUTO/MANU button to select AUTO. The AUTO light turns ON.
- 4 On the TUNING buttons, press ▲ to move up the broadcast band, or ▼ to move down the broadcast band.

The tuner stops automatically when it finds a strong station, and the TUNED light turns ON. If the station is broadcasting in stereo, the STEREO light turns ON.

- 5 Press ▲ or ▼ again to find the next strong signal.

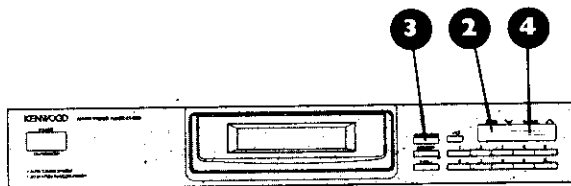

Tuning stations manually

You can search for radio stations in small steps up and down the broadcast band to tune in a weak station that automatic tuning might miss.

- 1 Select the TUNER input.
- 2 Press the BAND button to select FM or AM.
- 3 Press the AUTO/MANU button to select MANUAL. The AUTO light turns OFF.
- 4 On the TUNING buttons, press ▲ to move up the broadcast band, or ▼ to move down the broadcast band to the station you want.

The frequency changes by 0.1 MHz (FM) or 10 kHz (AM) each time you press the button, or it continually changes if you hold the button down.

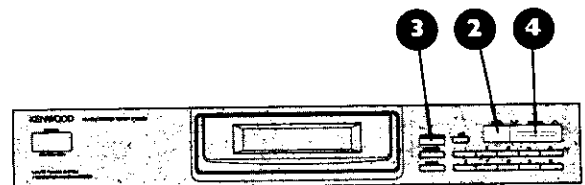

Important:

During manual tuning, the tuner receives stations only in mono.

- To receive a tuned station in stereo, press the AUTO/MANU button so the AUTO light turns ON. If the station is broadcast in stereo, you receive it in stereo.
- Weaker stations will be received with more background noise in stereo than in mono. To decrease the noise, press the AUTO/MANU button so the AUTO light goes OFF.

Storing preset stations

You can store up to 30 of your favorite radio stations in memory.

- 1 Tune in the station you want to preset.
- 2 Press the MEMORY button. The MEMORY light turns ON.
- 3 Within 5 seconds, enter the preset number using the number buttons. For example, to select preset #15, press the +10 button, then 5. To select preset #20, press the +10 button, the +10 button again, then 0.

If you've already assigned a station to a preset number, assigning a new station erases the old one.

- 4 To preset additional stations, repeat these steps.

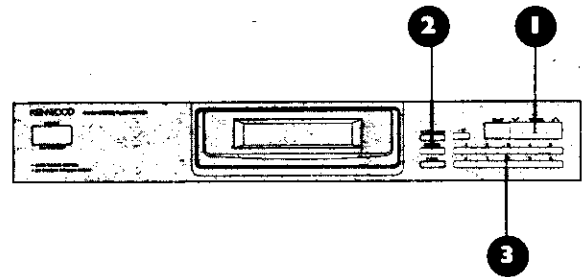

Tuning preset stations

You can quickly tune to any preset station.

Tuning from the front panel

- 1 Select the tuner input on the amplifier.
- 2 Press the number buttons assigned to the station.

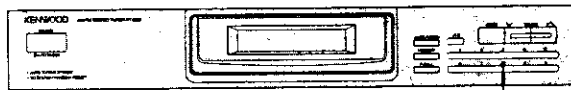

Tuning from the remote

- 1 Use the INPUT buttons to select the tuner input.
- 2 Press the AUDIO button until AUDIO appears on the remote's display.
- 3 Press the number buttons assigned to the station.

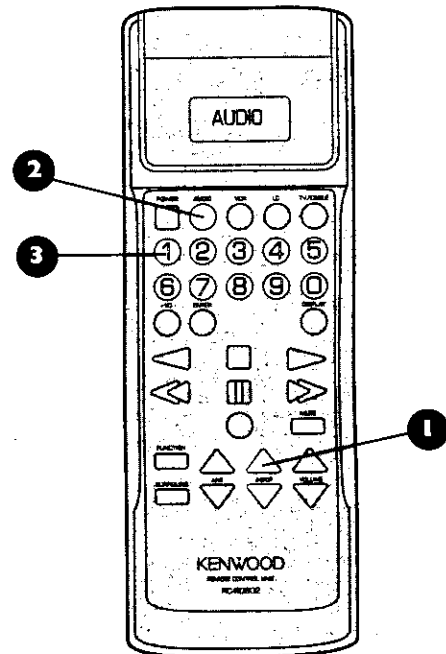

Scrolling through preset stations.

You can scroll through all preset stations in sequence.

- 1 Select the tuner input on the amplifier.
- 2 Press the P.CALL (Preset Call) button. Each time you press the button, the tuner advances to the next preset station number. The display shows the preset numbers.

If you hold the button down, the tuner advances through the preset stations at 1/2-second intervals. When you release the button, you hear the station tuned in at that time.

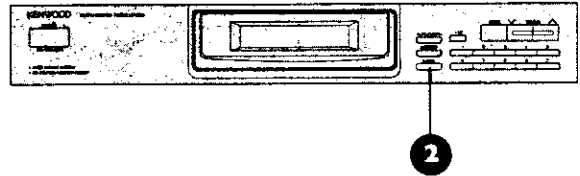

Using the CD player

The front panel controls and display

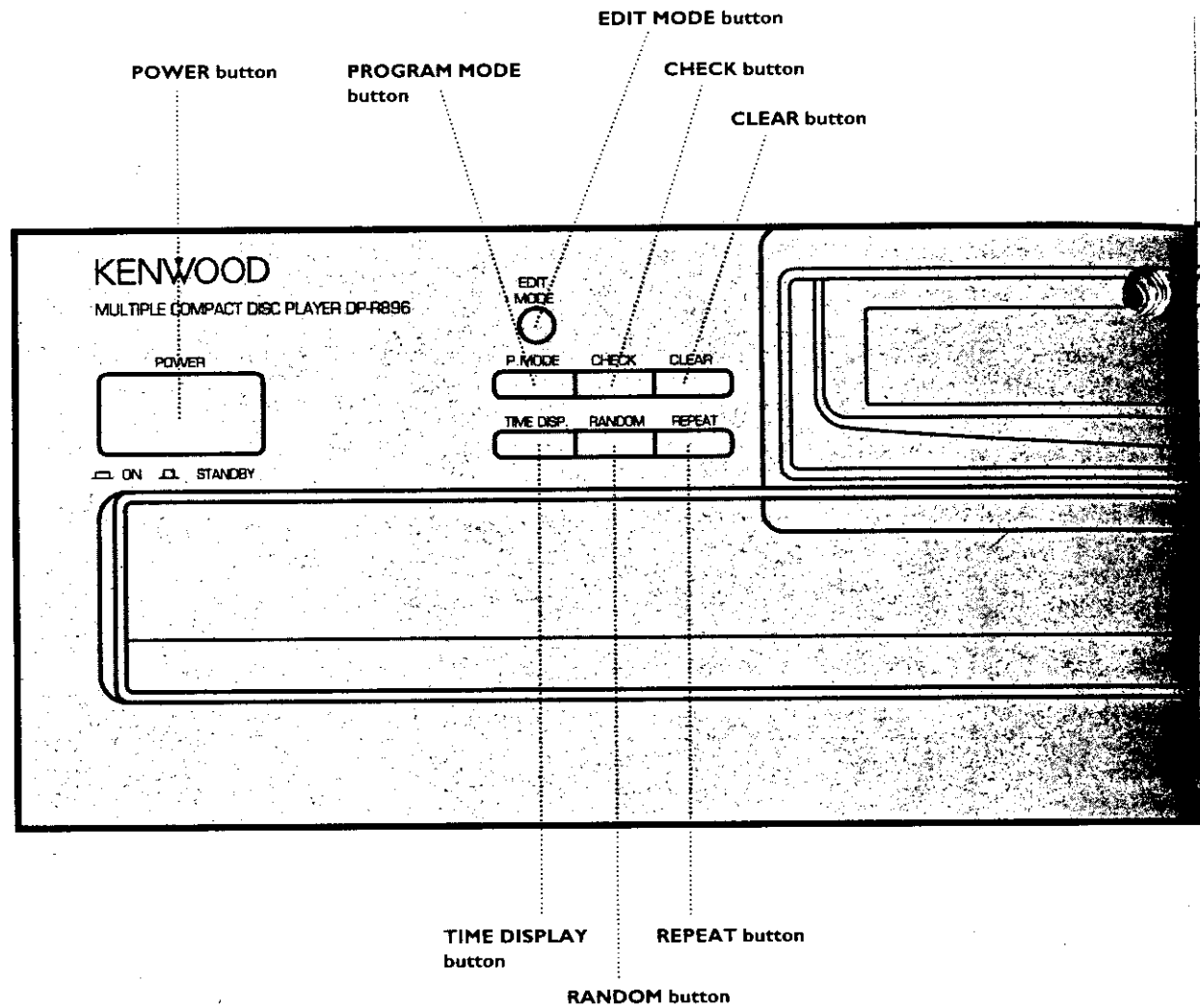

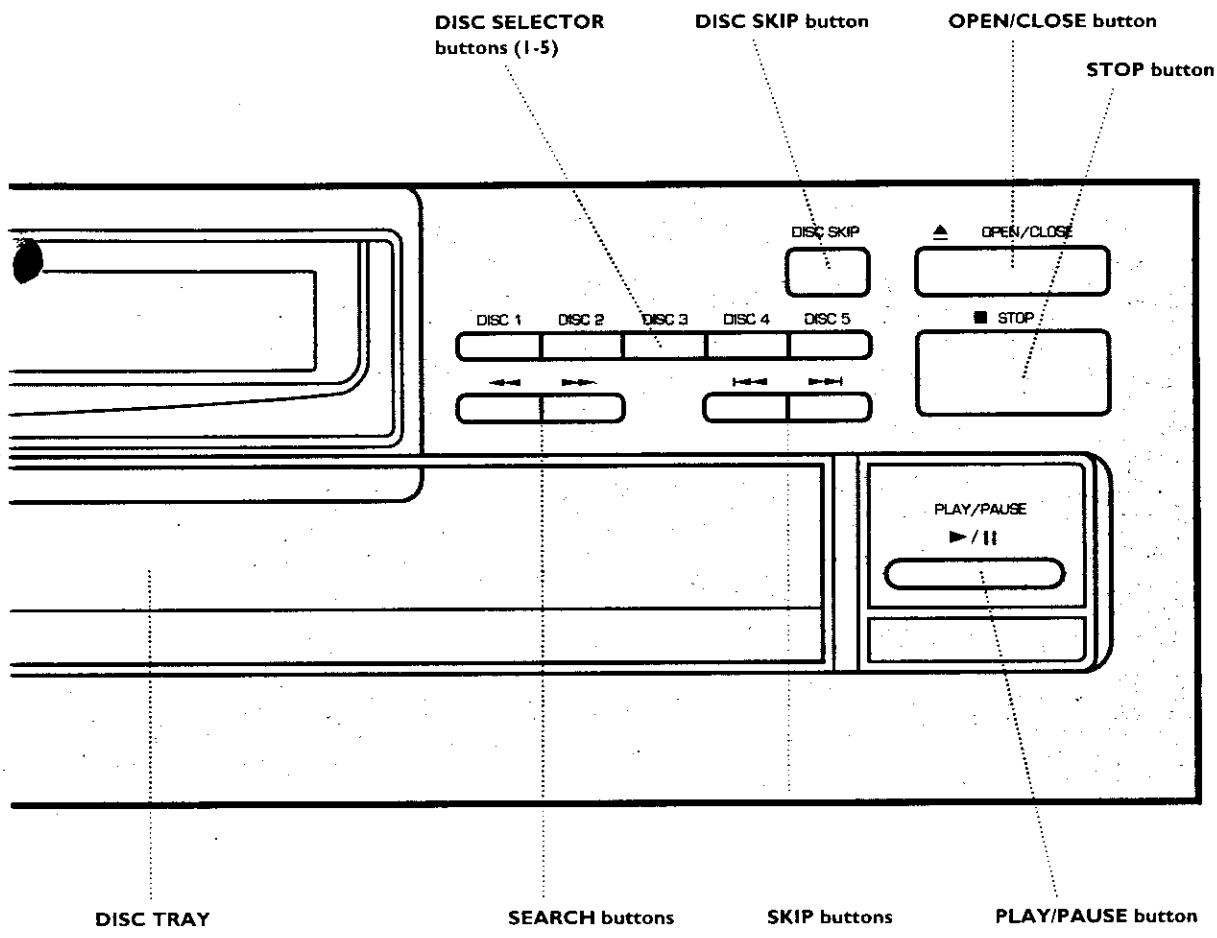
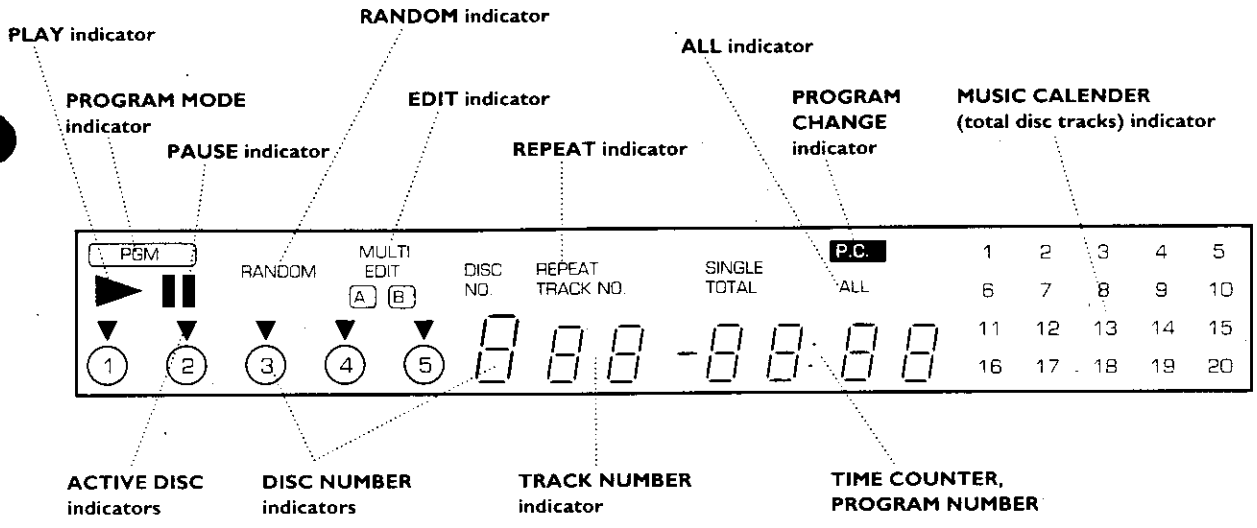

Before using the CD player

Please read the following instructions carefully to help prevent damage to your CD player and your CDs.

Compatible CDs

Your CD player plays standard 5" CDs and 3" CD singles and the audio portion of CDV discs and CD-G (CD plus graphics) discs.

Handling CDs

Hold a CD by its edges and center hole. Don't touch the playing surface or attach labels or tape to either side of the CD.

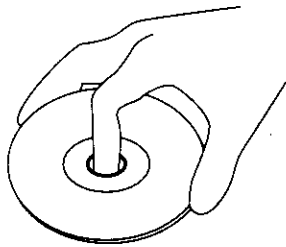

Cleaning CDs

To clean fingerprints or other dirt from a CD, gently wipe it with a soft cotton cloth moving in straight lines outward from the center.

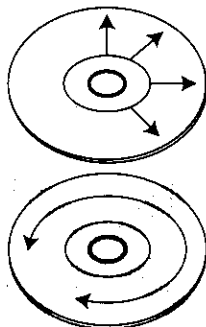

Storing CDs

To protect your CDs, store them in their cases. Don't leave them in the player for a long time.

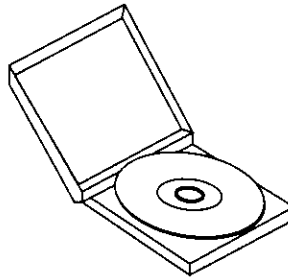

Damaged CDs

To avoid possible damage to your player, don't attempt to play cracked or warped CDs.

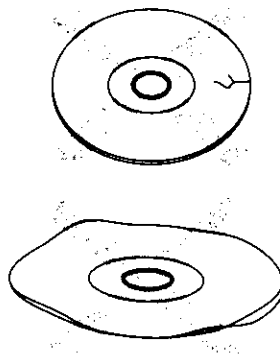

Condensation

Condensation of water vapor on the pickup lens may prevent proper operation of your CD player. To eliminate the condensation, leave the player ON for several hours. Condensation may occur when:

- You bring the player from a cool or cold place to a warm or humid place.

- You operate a heater in the vicinity of the player.
- There's a big difference between the player's internal temperature and the temperature of the room the player is in.

Before you transport your CD player

- 1 Turn the player's power ON. Don't load any CDs.
- 2 Wait until 5 seconds after NO DISC appears on the display.
- 3 Turn the player's power OFF.

Displaying CD time information

You can view time information for the CD you're playing.

Press the TIME DISP. button to cycle between:

- TRACK TIME: Elapsed and remaining time of the current track.
- TOTAL TIME: Elapsed and remaining time of the CD.

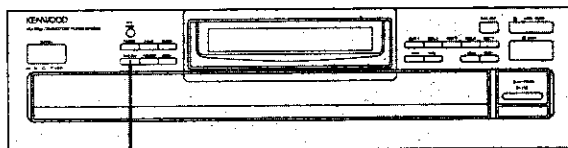

Loading CDs

- 1 Press the OPEN/CLOSE button to open the tray.
- 2 Place a CD in one of the tray's circular wells. While the tray is open, you can insert a CD in each of the 2 exposed wells.

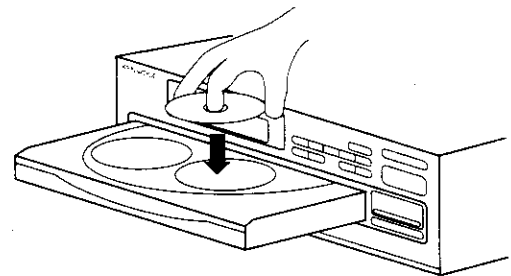

- 3 To insert more CDs, press the DISC SKIP button to rotate the tray. Insert a CD when the tray stops rotating.
- 4 When you're done, press the OPEN/CLOSE button to close the tray.

Changing CDs

During play

- 1 Press the OPEN/CLOSE button to open the tray.
- 2 Change the CDs in the exposed wells. If you want to put CD in an unexposed well, press the DISC SKIP button to rotate the tray. You can't change the CD currently playing.

When the player is stopped

- 1 Press the OPEN/CLOSE button to open the tray.
- 2 Change CDs in the exposed wells. If necessary, press the DISC SKIP button to rotate the tray.

Playing CDs

From the beginning

Playing from the front panel

- 1 Load one or more CDs.
- 2 Select the CD using the DISC SELECTOR buttons. An indicator ▼ appears on the display over the number of the selected CD. The selected CD automatically begins playing.

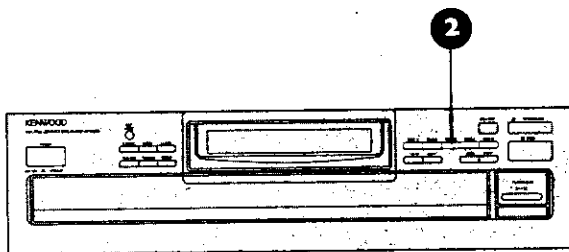

Whether you use the front panel or remote:

- If you don't select a CD when you've inserted more than 1 CD, the CDs play in order, starting with the CD in the lowest-numbered CD well.
- If you don't select a CD and you press the PLAY/PAUSE button, play begins with the CD number currently indicated on the display.

Playing from the remote

- 1 Load one or more CDs.
- 2 Press the AUDIO button until CD appears on the remote's display.
- 3 Select the CD using the FUNCTION button. An indicator ▼ appears on the player's display over the number of the selected CD. The selected CD automatically begins playing.

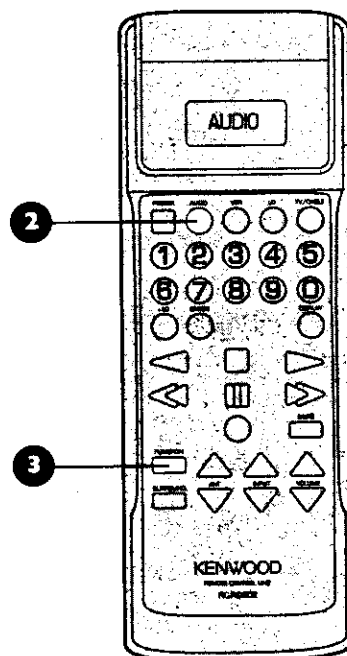

From a specific track

Playing from the front panel

- 1 Make sure that the PGM (Program Mode) light is OFF. If the PGM light is ON, press the P.MODE button.
- 2 Select the CD using the DISC SELECTOR buttons.
- 3 Select the track using the TRACK SKIP buttons. Play begins from the selected track and continues.

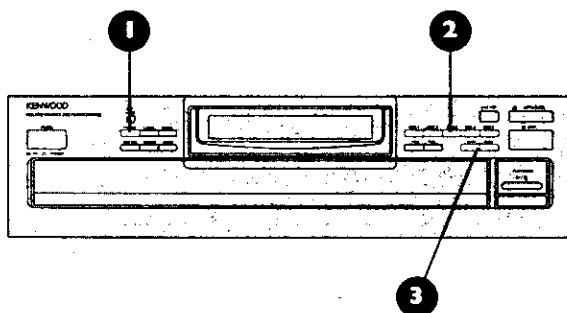

Playing from the remote

- 1 Make sure that the PGM light is OFF. If the PGM light is ON, press the P.MODE button.
- 2 Press the AUDIO button until CD appears on the remote's display.
- 3 Select the CD using the FUNCTION button.
- 4 Select the track using the ◀ and ▶ buttons, or enter the track number with the number buttons. Play begins from the selected track and continues.

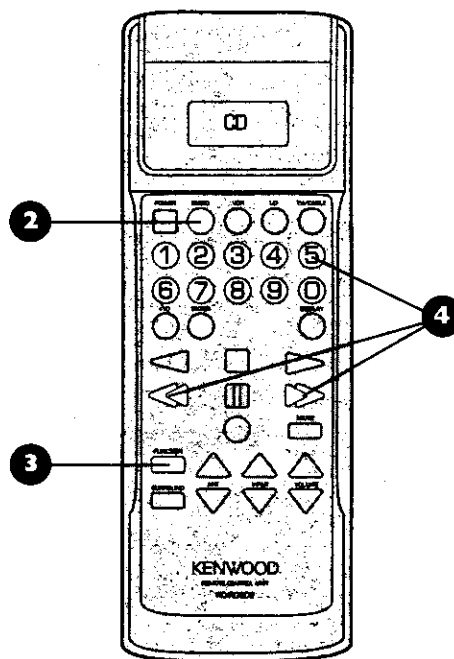

Playing a combination of tracks

You can program up to 32 tracks from any combination of CDs to play in any order.

A few hints:

- The player automatically adds a space of about 4 seconds between tracks in the PGM mode. This makes it easy to record tapes that are compatible with the track-finding function of Kenwood cassette decks. However, the PGM mode also inserts a 4-second space between 2 continuous, consecutive tracks programmed into memory, such as those on classical and live recordings.
- If you select the wrong track, press the CLEAR button, and select the correct track.
- When selecting tracks using the number buttons on the remote, you don't have to press the P.MODE button after each selection.
- Once you've programmed 32 tracks, the display indicates FULL, and you can't program any more tracks.
- If you press one of the SKIP buttons during Programmed play, the player skips the current track either forward or backward.

Programming tracks

- 1 Press the STOP button.
- 2 Press the P.MODE button. The PGM light turns ON.
- 3 Select a CD.
- 4 Select a track.
- 5 Press the P.MODE button. The PLAY light flashes, and the display shows the selected CD and track and indicates P--01.
- 6 Repeat steps 3 through 5 above to program each track.
- 7 Press the PLAY button to play.

You can program all the tracks on a CD (in order) by pressing the P.MODE button without selecting any track numbers. The CD takes up only 1 program memory slot, regardless of how many tracks are on it.

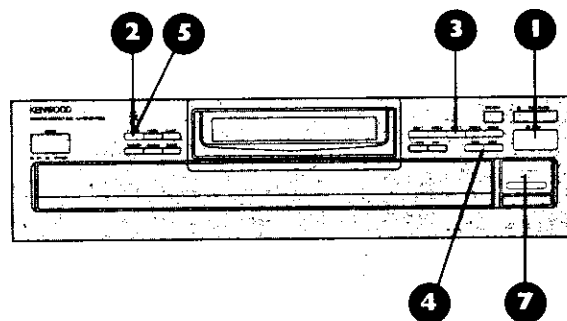

To check a program

Press the CHECK button. Each time you press the button, you see the CD and track numbers in the order you programmed them on the display.

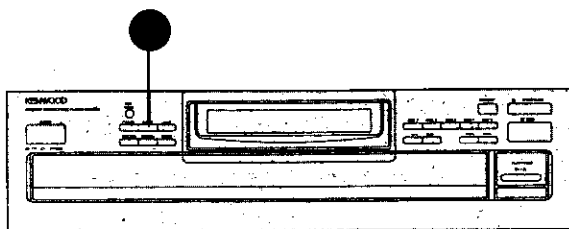

To resume normal play

Press the P.MODE button. After the current track is done, the tracks continue to play in the order on the CD.

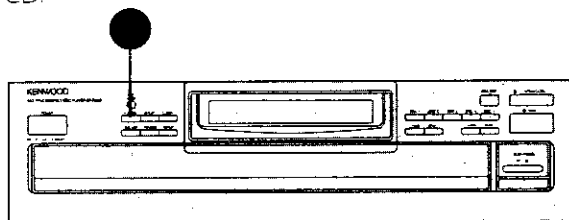

To stop programmed play

Press the STOP button.

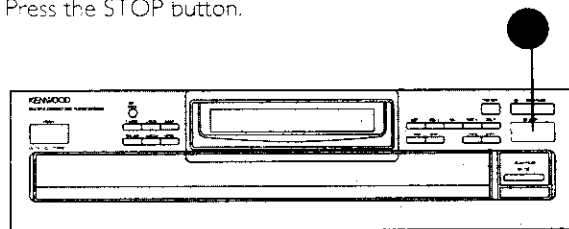

Adding a track to a program

You can add another track to the end of a program after the program has started playing.

- 1 Press the STOP button.
- 2 Select the CD and track to add.
- 3 Press the P.MODE button and then press PLAY.

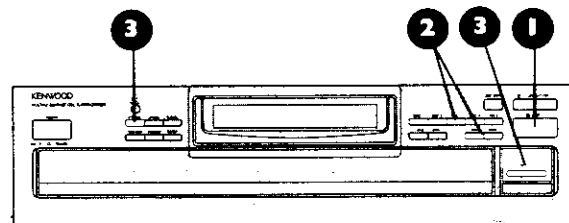

Changing a track in a program

You can change a track in a program after the program has started playing.

- 1 Press the STOP button.
- 2 Press the CHECK button until you see the P—# you want on the display. The P.C. light turns ON.
- 3 Select the new CD and track.
- 4 Press the P.MODE button and then press PLAY.

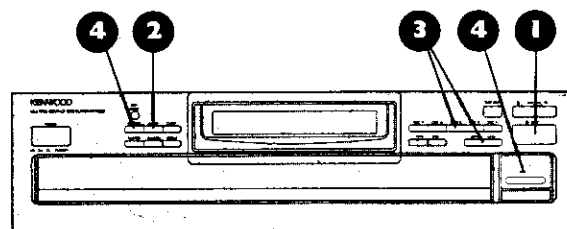

Clearing a track in a program

You can clear upcoming tracks in a program while it's playing.

Press the CLEAR button. Each time you press the button, you clear the tracks in order from the last track. You can't clear the track currently playing.

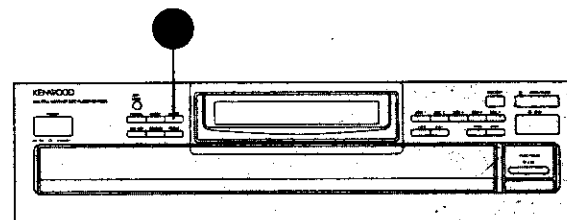

Clearing a whole program

Press either the P.MODE button or the OPEN/CLOSE button.

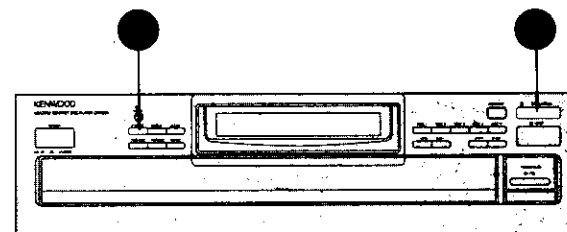

Playing CDs over (repeat play)

You can repeat a single CD, all loaded CDs, or the contents of a program.

Repeating a single CD

- 1 Press the STOP button.
- 2 Press the P.MODE button. The PGM light turns ON.
- 3 Select a CD.
- 4 Press the REPEAT button. The REPEAT light turns ON.
- 5 Press the PLAY button.

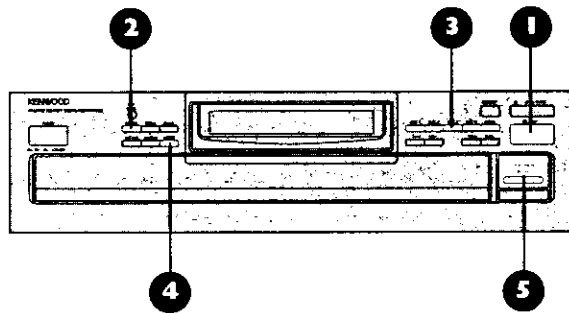

Repeating all loaded CDs

- 1 Make sure that the PGM light is OFF. If the PGM light is ON, press the P.MODE button.
- 2 Press the REPEAT button. The REPEAT light turns ON.
- 3 Press the PLAY button.

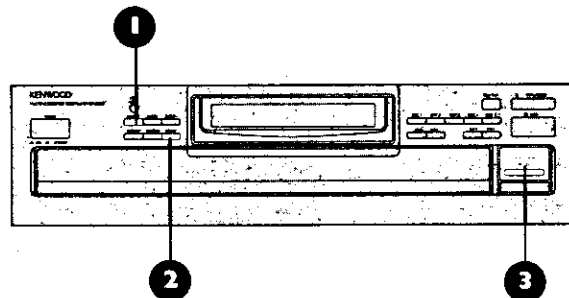

Repeating programmed tracks

You can repeat a programmed combination of tracks (see page 36, 'Programming Tracks'). If you only programmed, 1 track, it plays over and over again.

- 1 Press the STOP button.
- 2 Press the REPEAT button. The REPEAT light turns ON.
- 3 Press the PLAY button.

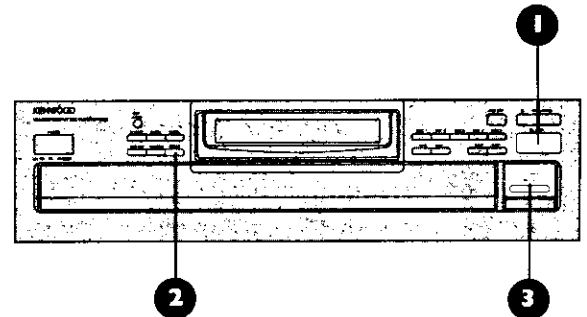

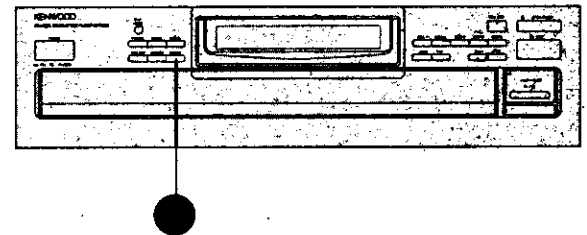

To stop repeat play

Press the REPEAT button while repeat play is ON. The REPEAT light goes OFF.



Recording from a CD (with automatic start and stop)

You can tape automatically without cutting off the first few seconds of sound—the CD player and tape deck start and stop simultaneously. This method lets you set the recording level to your liking.

- 1 Put a blank tape in tape well B.
- 2 Set the recording level and recording balance (see page 46).
- 3 Select the tape direction ◀ or ▶, and immediately press the STOP button.
- 4 Select the recording mode:
 records on both sides of the tape.
 records on one side of the tape.
- 5 Select the Dolby Noise Reduction mode.
- 6 Press the REC PAUSE button.
- 7 Press the PLAY/PAUSE button on the CD player. Recording begins when you push the button.

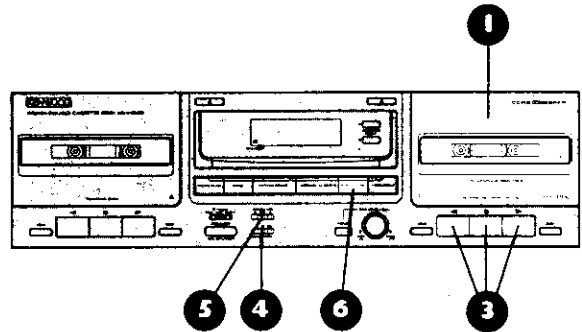

When the CD stops, the recording stops, and the player stops.

To pause the recording

Press the PLAY/PAUSE button on the CD player. You can skip to another track.

To resume recording

Press the PLAY/PAUSE button on the CD player again.

To stop recording

Press the STOP button on the CD player.

If you press the ■ button on the cassette deck, recording stops, but the CD player keeps playing.

Creating custom tapes from CDs

You can tape up to 32 tracks from one or more CDs to fit a particular tape length. The player automatically edits the order of the tracks, so no track is cut off at the end of the tape.

Taping a single CD

Your CD player automatically selects the number of tracks (in numerical order) to best fill Side-A. The player selects the tracks for Side-B the same way.

- 1 Make sure the PGM light is OFF. If the PGM light is ON, press the P.MODE button.
- 2 Press the STOP button.
- 3 Press the EDIT MODE button once. The EDIT light turns ON.
- 4 Select the CD you want to tape using the DISC SELECTOR buttons.
- 5 Press the TIME DISP. button, and enter the recording time of the tape. Each time you press the button, the time cycles from 46 > 54 > 60 > 90 and then back to 46. The time you selected flashes on the display.

You can adjust the time by pressing the DISC SKIP buttons. Each time you press the appropriate button, you increase or decrease the time by 1 minute.

You can also enter the time by using the number buttons on the remote. In this case, you don't have to press the EDIT MODE button after entering the time.

- 6 Press the EDIT MODE button again. The EDIT light flashes, and the display shows the tracks selected for Side-A and then the tracks for Side-B. Finally, the PLAY light flashes, while the EDIT light remains ON.
- 7 To start recording, press the CCRS button on the cassette deck. Recording begins after about 1 minute. For an explanation of CCRS, see page 48.

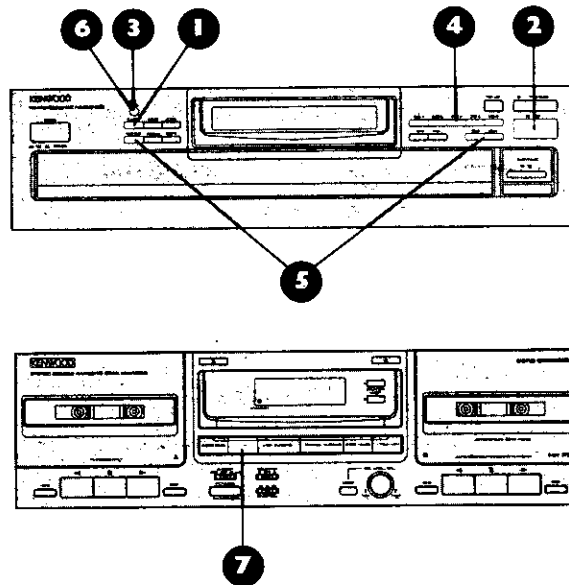

Taping tracks from multiple CDs

You can record tracks from more than one CD onto a single tape.

- 1 Make sure the PGM light is OFF. If the PGM light is ON, press the P.MODE button.
- 2 Press the STOP button.
- 3 Press the EDIT MODE button twice. The MULTI EDIT light turns ON.
- 4 Press the TIME DISP. button, and enter the recording time of the tape. Each time you press the button, the time cycles from 46 > 54 > 60 > 90 and then back to 46. The time you selected flashes on the display.

You can adjust the time by pressing the DISC SKIP buttons. Each time you press the appropriate button, you increase or decrease the time by 1 minute.

You can also enter the time by using the number buttons on the remote. In this case, you don't have to press the EDIT MODE button after entering the time.

- 5 Press the EDIT MODE button again.
- 6 Select the CD you want to tape using the DISC SELECTOR buttons.
- 7 Select the tracks to tape using the TRACK SKIP buttons.

If you make a mistake, press the CLEAR button, and select the correct track.

- 8 Press the P.MODE button after each track selection. The display shows the time remaining on Side-A.

If the time remaining on Side-A is shorter than the track you selected, that track is programmed onto Side-B. When B-FULL is displayed, both sides are full.

- 9 To tape from more than 1 CD, repeat steps 6 through 8.
- 10 To tape, press the CCRS button on the cassette deck. Recording begins after about 1 minute. For an explanation of CCRS, see page 48.

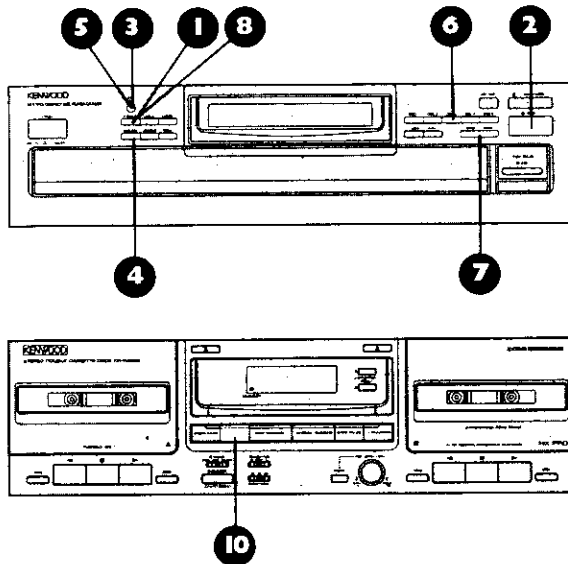

Checking the tracks you've selected

For a single CD, press the CHECK button. The track numbers of the selected tracks are automatically displayed.

For multiple CDs, press the CHECK button. Each time you press the button, you advance the display to the next track number.

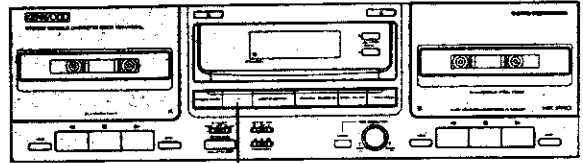
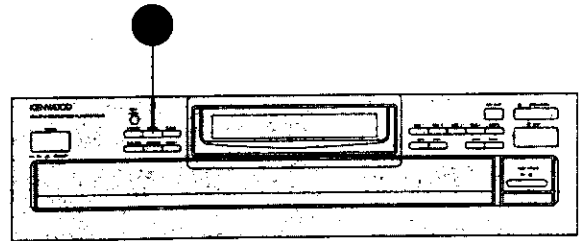

Clearing tracks from the selection

For a single CD, press the P.MODE or the OPEN/CLOSE button.

For multiple CDs, press the P.MODE button.

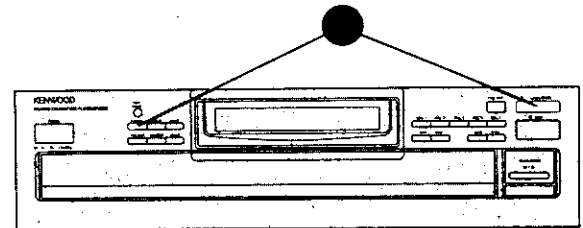

Using a timer to record from the tuner

You can set the cassette deck to record from the tuner at a preset time (to record a specific radio show, for example).

- 1 Connect the power cords of the Spectrum system to the audio timer so that the timer turns the system ON. Follow the instructions included with the timer.
- 2 Turn the system ON.
- 3 Tune in the radio station.
- 4 Insert a blank tape in tape well B.
- 5 Set the recording mode, Dolby Noise Reduction, and adjust the recording level. Make sure you're selected TUNER on the receiver.
- 6 Set the timer.
- 7 Set the TIMER switch on the cassette deck to REC.

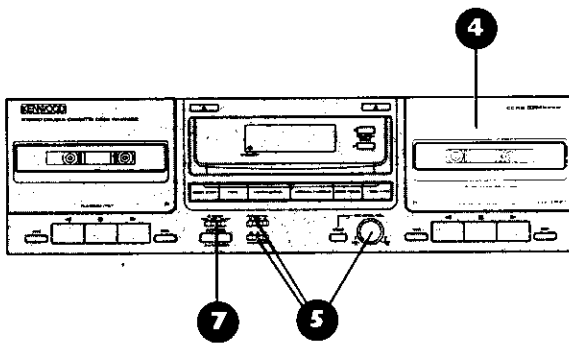



To ensure that the cassette deck's automatic shutoff works properly, set the timer to operate for a little longer than the length of the tape.

Recording from a record (with automatic start and stop)

You can make tapes from your records if you have a Kenwood turntable connected to your Spectrum system with a system control cable. The record and tape deck will start and stop simultaneously.

- 1 Put a blank tape in tape well B.
- 2 Select the tape direction ◀ or ▶.
- 3 Immediately press the STOP button.
- 4 Select the recording mode:

 records on both sides of the tape.

 records on one side of the tape.

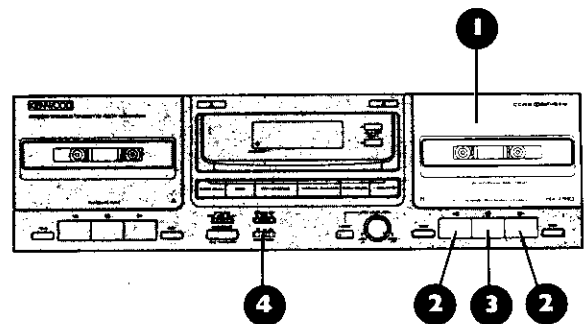

- 5 Select the Dolby Noise Reduction mode.

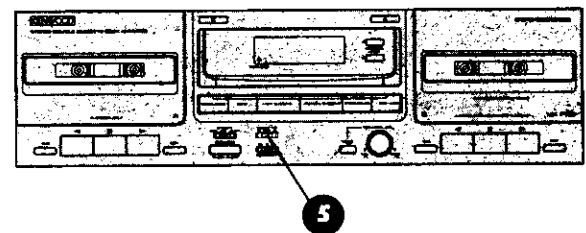

- 6 Adjust the recording level according to the instructions in 'Setting the recording level and balance' on page 46.

7 Press the REC PAUSE button.

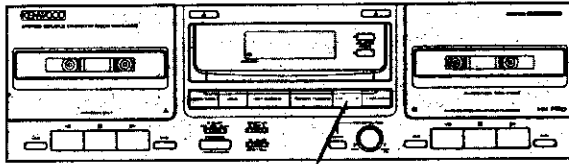

8 Press the PLAY/CUT button on the turntable to start recording.

When the turntable stops, the recording stops, and the player stops.

To stop recording

Press the PLAY/CUT button on the turntable.

If you press the ■ button on the cassette deck, the cassette deck stops, but the turntable keeps playing.

Copying (dubbing) a tape

You can automatically copy a tape in tape well A onto a tape in tape well B. You can copy at normal speed or at high speed, which takes half the time.

A few tips:

- You can't adjust recording level and balance during copying. They are set automatically.
- The new recording in tape well B will automatically have the same noise reduction as the original recording in tape well A. This means you can't add Dolby Noise Reduction during dubbing.
- If the original tape is recorded at very high volume levels, use normal-speed copying for best results.
- Noise from a nearby TV may cause interference during high-speed copying. If this happens, turn OFF the TV.

1 Insert the tape to copy into well A, and a blank tape into well B.

2 Make sure that both wells are set in the same direction, and immediately press the STOP button.

3 Select the copying (dubbing) mode:

 copies both sides of the tape.

 copies one side of the tape.

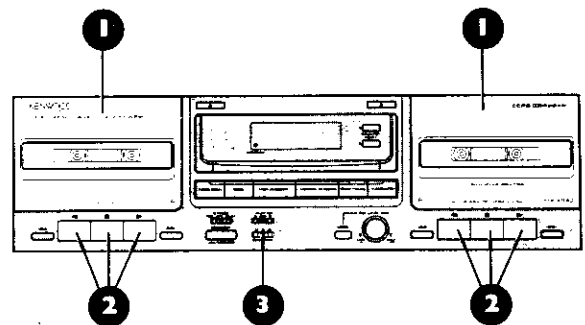

- 4 Press the NORMAL DUBBING button for normal-speed copying or the HIGH DUBBING button for high-speed copying, and the taping starts.

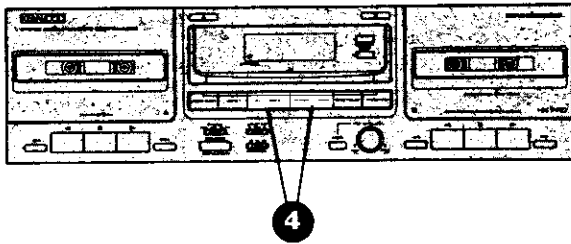

To pause dubbing

If you're in normal copying mode, press the NORMAL DUBBING button.

If you're in high-speed copy mode, press the HIGH DUBBING button.

Well B pauses after putting a 4 to 6-second blank space on the tape.

You can skip unwanted tracks on the tape in tape well A by pressing the ►► button under well A.

To resume dubbing

If you're in normal copying mode, press the NORMAL DUBBING button again.

If you're in high-speed copy mode, press the HIGH DUBBING button again.

To stop dubbing

Press the ■ button of well B.

the outdoor antenna away from roads.

None of the functions operate, or the display shows wrong information

- Reset your unit's microcomputer by unplugging the power cord from the electrical outlet and plugging it back in while holding down the MEMORY button.

CD player

Power light doesn't come on

- Check that the power cord is properly plugged into the electrical outlet on the back of the power amplifier.

Player doesn't play a loaded CD

- Check that the CD is loaded right-side up.
- Check that the CD isn't cracked or dirty.
- There may be condensation on the lens. Leave the player on for at least 1 hour before using it.

No sound

- Check that the CD is loaded properly.
- Check that the CD isn't cracked or dirty.
- Check that the PLAY mode is active (the PLAY/PAUSE light should be ON).
- Check that the audio cables are connected properly.

Skipping (mis-tracking)

- Check that the CD isn't cracked or dirty.
- Make sure that the player isn't subjected to strong vibrations.

CD automatically plays when power is turned on

- Remove all CDs before turning your unit OFF. The player is designed to automatically begin playing when the power is turned ON.

Cassette deck

No sound when the PLAY button is pressed

- Check that the tape isn't blank.
- Check that the tape is wound properly in the cassette case. If not, replace the tape.
- Check that the audio cables are connected properly.

None of the operation buttons work

- Make sure that a tape has been inserted into the well.
- Make sure the cassette well door is completely closed.
- After closing the cassette well door or turning on the power, wait at least 3 seconds before pressing the buttons.
- Make sure that the tape isn't fully wound to the end. If it is, change the tape direction or reinsert the tape facing the other direction.
- Check that the tape is wound properly in the cassette case. If not, replace the tape.

Track-finding function doesn't work

- Make sure that the tape has 4-second blank spaces between tracks.

Automatic recording doesn't work

- Make sure that the recording-activation tabs have not been removed from the tape in tape well B.
- Make sure there is a CD in the CD player.
- Check that the CD isn't cracked or dirty.
- Check that the system control cables are properly plugged in.

The cassette well door doesn't open when the EJECT button is pressed

- Make sure that the player is in the STOP mode.

Recordings sound dull or distorted

- The recording level may be too high. Set the recording level according to the section 'Setting recording level and balance' on page 46.
- Make sure that Dolby Noise Reduction isn't activated

when playing tapes recorded with no Dolby Noise Reduction.

- You may need to clean the tape heads. See the section 'Before using your cassette deck' on page 42.

Pressing the REC/ARM button doesn't start recording

- Make sure that the recording-activation tabs have not been removed from the tape.
- Make sure that the cassette well door is completely closed.
- Make sure that the input on the amplifier is set to something other than TAPE.
- Check that the recording level isn't set to minimum.
- Check that the tape isn't fully wound to the end.

Tape noise (hiss) level is high

- Make sure that the proper Dolby Noise Reduction is selected for play.
- The tape may have been recorded at too low a recording level. If so, record it again at a higher level.
- You may need to demagnetize the tape head. See the section 'Before using your cassette deck' on page 42.

Sound is 'sour', with unstable pitch

- You may need to clean the tape heads. See the section 'Before using your cassette deck' on page 42.
- Make sure that the tape is wound properly in the cassette case.

Tape automatically plays or records when power is turned ON

- Make sure that the TIMER switch is OFF.

None of the functions operate, or the display shows wrong information

- Reset your unit's microcomputer by unplugging the power cord from the electrical outlet and plugging it back in while holding down the STOP button.

Set-up codes for video components

VCR

Maker	Set-up code
-------	-------------

Aiwa	0-5
Akai	056, 064, 068, 076, 121, 257
Akura	286
Alpa	035, 224
Amstrad	015
ASA	052, 096
Barco	119
Baupunkt	045
Broksonic	136, 199, 226
Bush	087, 224
Canon	050, 182
Capehart	035
Carver	096
Craig	062, 255, 286
Curtis Mathes	050
Daewoo	035, 060, 061, 102, 293
Daytron	035
Decca	096
Degraaf	057
Dual	056
Dumont	096, 119
Dynatech	015
Emerson	015, 017, 052, 076, 136, 199, 223, 224, 226, 227, 309
Ferguson	056
Finlandia	096, 119, 125
Finlux	015, 057, 096, 119
Fisher	062, 069, 081, 119
Funai	015
GO	50, 075, 080
Go Video	247, 294
Goldstar	033, 052, 053
Goodmans	077, 087
Graetz	056

Granada	061, 096, 119
Grundig	096
Harmon-Kardon	053, 090
Hinani	087, 223
Hitachi	015, 056, 057, 080, 120, 181
Interfunkm	096
ITT	056, 119, 121
JCL	050
Jensen	056
JVC	023, 056, 082
Kenwood	056, 061, 082
Lloyd	015
Loewe Opta	096
Logik	087
Luxor	121
LXI	052
Magnavox	050, 096, 125, 164
Marantz	050, 053, 077, 096
Marta	052
Matsui	223, 224
MEI	050
Memorex	015, 050, 052, 054, 061, 062, 063, 119
MGA	058, 076
Minolta	057, 120
Mitsubishi	058, 076, 082, 090, 096, 188, 229, 257
MTC	015, 255
Multitech	015, 087
NAD	073
NEC	053, 055, 056, 065, 082, 097
Nokia	056, 119
Nordmenc	056
Optonica	063, 077
Onon	223, 224
Osaki	052
Panasonic	045, 050, 092, 397
Penney	050, 053, 055, 057, 255

Pentax	057, 080, 120
Percio	015
Phico	050
Philips	050, 077, 096, 125
Phonola	096
Pilot	052
Pioneer	073, 082
Portland	035
Pulsar	054
Py	096
Quartz	061
Quasar	050, 111
RCA	050, 057, 075, 080, 092, 120, 164, 217
Realistic	015, 050, 052, 061, 062, 063, 077, 081, 119, 255
Rex	056
Rinnh	049
Runce	054
Saba	056
Saisho	223, 224
Salora	058, 061
Samsung	060, 068, 255
Sansui	056, 082, 097, 286
Sanyo	061, 062, 119
SBR	096
Schaub Lorenz	056
Schneider	087, 125
Scott	136, 199, 225, 227
Sears	050, 052, 057, 061, 062, 069, 081, 119, 120
Sentra	035
Sharp	063, 077
Shintom	087
Sony	047, 048, 049, 050
STS	057
Sylvania	050, 058, 096, 125
Symphonic	015
Tandy	015, 119

Tashiko	015
Tatung	056
TEAC	015, 056
Technics	050
Teknika	015, 050, 052, 067
Telefunken	056
Thomson	056
Thorn	056
Toshiba	056, 058, 060, 081, 225, 227
Totivision	052, 255
Triumph	233
Unitech	255
Vector Research	053, 055
Victor	023, 082
Video Concepts	055, 076
Videosonic	255
Wards	015, 050, 057, 062, 063, 077, 087, 164, 221, 255
Yamaha	053, 056
Zenith	048, 049, 054

Laser disc player

Maker	Set-up code
Aiwa	218
Carver	079
Denon	187
Funa	218
Kenwood	251, 273
Magnavox	079
Marantz	079
Mitsubishi	074
NAD	074
Panasonic	219, 245
Philips	079
Pioneer	074
RCA	366
Realistic	218
Sharp	016
Sony	208, 216
Yamaha	232

TV

Maker	Set-up code
A-Mark	018
Akai	024, 113
Alpa	233
Amstrad	024, 186, 192
Anam	019, 024, 195
Anam National	070
AOC	018, 034, 045, 067, 152
Archer	018
Arcom Delta	231
Archer	018
Audio-Technica	068
Audiosonic	052
Audiovox	018
Bauer	080
Bush	052
Candor	045, 061, 071, 201
Capehart	067
Carver	069
Cimrin	024
Citizen	045, 054, 061, 071, 075, 107, 201
Concerto	071
Contec	024, 173, 195, 200
Crag	195
Crown	054
Curtis Mathes	045, 054, 075
CXC	195
Daewoo	024, 034, 054, 106, 107
Dansat	052
Davtron	054
Decca	064
Dixie	019, 024, 052
Dynatech	064
Electrohom	054
Eita	024
Emerson	054, 173, 192, 193, 194, 195, 196, 197, 198, 200, 251, 285, 295, 297
Envision	045
Etron	024
Fidelity	231
Finlux	052
Fisher	169, 174

Formenti	080
Fortress	108
Fujitsu	194
Funa	194, 195
Futuretech	95
GO	36, 042, 044, 062, 063, 066, 070, 185, 193, 294, 297
GeC	052
Geloso	024
Genexxa	233
Golostar	016, 017, 034, 052, 054, 071, 211, 192
Goodmans/Tasniko	051
Granada	052, 16
Hailmark	193
Hinnan	194
Hisawa	297
Hitachi	053, 054, 071, 110, 112, 160, 166, 188, 242, 294
Hypson	052
Infinity	069
Interfunk	052
JBL	069
Jensen	065
JVC	068
Kenwood	045, 171
Kloss	039, 067
KMC	121
KTV	054, 195, 200, 295
Loytron	047, 054
Loewe, Loewe Opta	052
Logic	031
Luxman	071
LX	062, 069, 163, 169, 171
Magnavox	035, 039, 043, 045, 069, 111, 201, 202
Marantz	045, 052, 069
Mark	052
Matsui	024, 052
Memorex	024, 031, 169
MGA	034, 045, 165, 170, 193
Mitsubishi	034, 051, 052, 113, 165, 170, 193
MTC	034, 045, 064, 071, 075, 106
Multitech	232
NAD	171, 181

NEC	034, 045, 051, 071, 185
Neckermann	052
NEI	052
Nikka	047, 052, 233
Onwa	195
Optonica	108, 180
Osaki	047
Otto Versand	052
Panasonic	066, 069, 070, 177
Pausa	024
Penne	033, 034, 036, 045, 047, 054, 062, 063, 073, 25 150, 164
Phico	034, 035, 029, 043, 045, 069, 201, 202
Philos	0, 5, 052, 069
Pioneer	053, 18
Portland	034, 054
Protect	052
Proton	046, 054, 067, 193
Pulsar	032
Quasar	066, 070, 234
Quel	052
R...n	052
Radio Shack	047, 054, 180, 195
Radio	052
RCA	033, 034, 044, 053, 150, 189, 192
Realistic	169
Roadstar	024
Sasno	024, 026, 92
Sampo	045, 067, 115, 123
Samsung	024, 034, 045, 047, 052, 054, 071, 075
Sarvic	035, 051, 161, 169, 174
SBR	052
Schneider	052
Scott	054, 194, 195, 151
Sears	062, 063, 069, 071, 164, 163, 164, 169, 171, 174, 193, 194
Sharp	051, 054, 108, 80
Signatur	03
Seavox	047
Sonoko	024, 052
Sony	015, 026, 051, 095, 126, 197, 288
Soundesign	93, 193, 201

Soundwav	052
Spectricon	018, 152
SSS	034, 195
Standard	024
Supra	071
Supre-Macv	067
Sylvania	035, 039, 043, 045, 069, 080, 201, 202
Symphonic	186
Tanda	054, 108, 232, 233
Tatung	064, 070, 232
Technics	066
Techwood	071
Technika	031, 034, 054, 061, 071, 075, 107, 165, 194, 195, 201
Teletech	024
Tera	046
TMK	071, 193
Toshiba	051, 075, 164, 169, 171
Tosonic	200
Totevision	054
Unversa	036, 042
Universum	052
vector Research	045
Victor	068
Video Concepts	113
victect	034, 193
Viking	061
Wards	031, 034, 035, 036, 042, 043, 044, 045, 069, 071, 111, 180, 189, 193, 194, 202
Yamaha	034, 045
Zenit	031, 032
Zonda	016

Cable box

Maker	Set-up code
ABC	022, 026, 028, 032
Antronix	222
Archer	054, 166, 222
Centun	166
Citizen	168

Colour Voic	044, 046
Comband	247, 248
Comtronics	055, 075
Eastern	017
Electricon	093
Garrard	168
G	247, 248
Gemini	030, 072, 085, 257
General Instrument	026
Hamlin	024, 035, 049, 274, 288
Hitachi	026
Jasco	168
Jemoid	018, 026, 029, 030, 039, 041, 062, 115
Macom	048
Magnavox	042
Memorex	015
Movie Time	093, 171
Northcoast	329
NSC	078, 085, 171
Oak	022, 034, 263
Panasonic	036, 122
Paragon	015
Philips	040, 042, 043, 044, 045, 046, 075, 305
Philips Ecg	257
Pioneer	038, 159, 275
Pulsar	015
RCA	036
Realistic	222
Regal	035, 274, 288, 294
Regency	017
Rembrandt	085
Samsung	053, 159
Scientific Atlanta	021, 023, 032, 292
Signa	030, 055
Signatur	026
SL Mark	055
Sprucer	036, 322
Standard Components	111
Starcom	018, 030, 062, 113
Stargat	030, 055
STS	171
Sylvania	016
Tandy	273
Tatung	112

Teknika	161
Telecaption	236
Texscan	016, 111
Tocom	027, 028, 074
Toshiba	015
TV86	078
Unika	168, 222
United Artists	022
United Cabl	018
Universal	054, 092, 093, 168, 206, 222
Videoway	265
Viewstar	042, 075, 078, 226, 273, 304
Zenith	015, 069

Specifications

Integrated amplifier (KA-996)

Power amp section

Power output in stereo operation:
100 watts per channel minimum
RMS, both channels driven, at 8
ohms, from 40 Hz to 20 kHz, with
no more than 0.09% total harmonic
distortion (FTC)

Power output in surround operation:
Left and right channels: 100 watts
per channel, 1 kHz, 0.9% THD, 8 ohms

Surround channel: 20 watts + 20
watts, 1 kHz, 0.9 % THD, 8 ohms

Pre amp section

Frequency response:
Line (CD, Tape, Video): 20 Hz to
60 kHz, +0 dB, -3 dB
Phono: (RIAA): 20 Hz to 20 kHz
+0.5 dB

Signal-to-noise ratio (IHF '66):
Phono: 75 dB
CD, Tape, Video: 95 dB

Maximum input level (Phono):
120 mV, 0.5 % THD at 1 kHz

Input sensitivity/impedance:
Phono: 3.5 mV/47 k-ohms
CD, Tape, Video: 200 mV/47 k-ohms
Adaptor loop input:
200 mV/47 k-ohms

Output level/impedance:
Tape record: 200 mV/1 k-ohm
Adaptor loop out: 200 mV/1 k-ohm

Tone controls:
Bass: +10 dB at 100 Hz
Treble: +10 dB at 10 kHz
Loudness control (volume at -30 dB):
+8 dB at 100 HZ

General

Power consumption: 2.3 amps

Electrical outlet (2 switched):
400 watts max total

Dimensions:
Width: 17-5/16"
Height: 5-5/8"
Depth: 11-13/16"
Weight (net): 20.5 lbs

Power amplifier (KM-996)

Performance

Power output:
100 watts per channel minimum
RMS, both channels driven, at 8
ohms, 1 kHz, with no more than
0.09 % total harmonic distortion

Frequency response:
10 Hz to 65 kHz +0 dB, -3 dB

Signal-to-noise ratio (IHF '66):
> 103 dB

Input sensitivity/impedance:
150 mV/40 k-ohms

General

Power consumption: 2.3 amps

electrical outlet (1 unswitched):
30 watts max

Dimensions:
Width: 17-5/16"
Height: 5-1/4"
Depth: 10-3/8"
Weight (net): 14.1 lbs

Tuner (KT-596)

FM tuner section

Tuning frequency range:
87.5 MHz to 108 MHz

Usable sensitivity (IHF):
13.2 dBf (1.2 mv at 75 ohms)

Total harmonic distortion (1 kHz):
Stereo: 0.7 %
Mono: 0.6 %

Signal-to-noise ratio at 65 dBf (IHF):
Stereo: 68 dB
Mono: 75 dB

Stereo separation at 1 kHz (IHF):
40 dB

Capture ratio: 2.0 dB

Selectivity (IHF +400 kHz): 50 dB

Image rejection ratio (98 MHz):
50 dB

IF rejection ratio (98 MHz): 50 dB

AM supression ratio: 37 dB

Frequency response:
30 Hz to 15 kHz, +0.5 dB, -3.0 dB

Output level/impedance (1kHz,
75kHz deviation): 0.6 V/3.3 k-ohm

AM tuner section

Tuning frequency range:
530 to 1700 kHz

Usable sensitivity:
12 mv/(500 mV/m)

Total harmonic distortion: 0.7 %

Signal-to-noise ratio: 48 dB

Selectivity: 30 dB

Image rejection ratio: 30 dB

Output level/impedance (30%
modulation, 1 mV input):
0.18 V/3.3 k-ohm

General

Power consumption: 10 watts

Electrical outlet (1 unswitched):
520 watts max.

Dimensions:
Width: 17-5/16"
Height: 2-15/16"
Depth: 9-5/8"
Weight (net): 4.8 lbs

CD player (DP-R896)

Format

System: Compact disc digital audio
system

Laser: Semiconductor laser

Channel format: 2 channel

Disc rotation speed:
200 to 500 rpm (CLV)

D/A converters: Dual 1 Bit

Oversampling digital filter:
8 fs (352.8 kHz)

Performance

Frequency response:
4 Hz to 20 kHz, +1.0 dB

Signal-to-noise ratio: >96 dB

Dynamic range: >94 dB

Total harmonic distortion + noise:
<0.007 % (1 kHz)

Channel separation: >90 dB (1 kHz)

Wow and flutter: Unmeasurable

Output level/impedance:
2.0 V/3.3 k-ohms

General

Power consumption: 10 watts

Dimensions:
Width: 17-5/16"
Height: 5-1/16"
Depth: 15-7/16"
Weight (net): 11 lbs

Cassette deck (KX-W896)

Format

Track system: 4 track, 2 channel

Recording system: AC bias (105 kHz)

Heads:

Well A: Playback head x 1

Well B: Record/playback head x 1

Erase head x 1

Performance

Wow and flutter: 0.08 % (WRMS)

Fast-wind time: Approx 96 seconds
(C-60 tape)

Frequency response:

Normal tape:

30 Hz to 17 kHz, +3 dB

High-bias tape:

30 Hz to 18 kHz, +3 dB

Signal-to-noise ratio (3% 3rd
harmonic distortion, high bias tape):

Dolby NR OFF: >58 dB

Dolby B NR ON: >67 dB

Dolby C NR ON: >75 dB

Harmonic distortion (315 Hz,
250 nWb/m, high bias tape): <1%

Input sensitivity/impedance:
122.8 mV/47 k-ohms

Output level/impedance:
775 mV/1.0 k-ohms

General

Power consumption: 20 watts

Dimensions:

Width: 17-5/16"

Height: 5-3/8"

Depth: 10-9/16"

Weight (net): 9.3 lbs

Speakers

Main speakers (JL-1106)

Drivers:

Woofer: 6-1/2" cone-type

Tweeter: 3/4" dome-type

Power handling: 100 watts

General

Dimensions:

Width: 9-3/4"

Height: 17-3/16"

Depth: 10-7/8"

Weight (net): 11 lbs

Subwoofer (SW-50)

Driver: 1 x 10" cone-type

Power handling: 140 watts

General

Dimensions:

Width: 17-5/16"

Height: 16-15/16" (with feet)

Depth: 13-3/8" (with grille)

Weight (net): 30 lbs

Center speaker (CRS-156 Center)

Drivers 2 x 4" full-range cone-type

Power handling: 100 watts

General

Dimensions:

Width: 17-5/16"

Height: 5-7/8"

Depth: 6-5/16"

Weight (net): 7 lbs

Surround speakers (CRS-156 Surround)

Drivers 1 x 4" full range cone-type

Power handling: 40 watts

General

Dimensions:

Width: 5-7/8"

Height: 7-7/8"

Depth: 6-5/16"

Weight (net): 3.1 lb

Because Kenwood follows a policy of continuous product improvement, these specifications may be changed without notice.

KENWOOD USA CORPORATION
PO Box 22745
Long Beach, California 90801-5745

