



Warnings, Cautions and Others

JVC

HOME THEATER SOUND SYSTEM

TH-BA3

—Consists of SP-THBA3F, RX-THBA3, SP-THBA3S and SP-THBA3W

DOLBY
DIGITAL
PRO LOGIC II

dts
Digital Surround

Thank you for purchasing a JVC product.
Before operation, please read the instructions carefully.

INSTRUCTIONS

GVT0289-025A[UJ]
0710WMKMDWJMM



© 2010 Victor Company of Japan, Limited

CAUTION (SP-THBA3F)

The $\odot/|$ button in any position does not disconnect the mains line. Disconnect the mains plug to shut the power off completely (the STANDBY lamp goes off). The MAINS plug or an appliance coupler is used as the disconnect device, the disconnect device shall remain readily operable.

- When the System is on standby, the STANDBY lamp lights red.
- When the System is turned on, the STANDBY lamp goes off.

The power can be remote controlled.

CAUTION (SP-THBA3W/RX-THBA3)

The power supply to the subwoofer is linked to the center unit. Disconnect the mains plug to shut the power off completely (the POWER ON lamp goes off). The MAINS plug or an appliance coupler is used as the disconnect device, the disconnect device shall remain readily operable.

- When the System is on standby, the STANDBY/ON lamp lights red.
- When the System is turned on, the STANDBY/ON lamp lights blue.

CAUTION

Battery shall not be exposed to excessive heat such as sunshine, fire or the like.

CAUTION

To reduce the risk of electrical shocks, fire, etc.:

- Do not remove screws, covers or cabinet.
- Do not expose this appliance to rain or moisture.

CAUTION

- Do not block the ventilation openings or holes. (If the ventilation openings or holes are blocked by a newspaper or cloth, etc., the heat may not be able to get out.)
- Do not place any naked flame sources, such as lighted candles, on the apparatus.
- When discarding batteries, environmental problems must be considered and local rules or laws governing the disposal of these batteries must be followed strictly.
- Do not expose this apparatus to rain, moisture, dripping or splashing and that no objects filled with liquids, such as vases, shall be placed on the apparatus.

Do not use another AC adaptor to connect this model.

- Manufactured under license under U.S. Patent numbers: 5,451,942; 5,956,674; 5,974,380; 5,978,762; 6,487,535 and other U.S. and worldwide patents issued and pending. DTS and DTS Digital Surround are registered trademarks and the DTS logos and Symbol are trademarks of DTS, Inc. © 1996-2008 DTS, Inc. All Rights Reserved.
- Manufactured under license from Dolby Laboratories. Dolby, Pro Logic, and the double-D symbol are trademarks of Dolby Laboratories.



[European Union only]
[Union européenne seulement]

Introduction

Notes on handling

Important cautions

Installation of the System

- Select a place which is level, dry, and neither too hot nor too cold; between 5°C and 35°C.
- Leave sufficient distance between the System and the TV.
- Do not use the System in a location near heat sources, or in a place subject to direct sunlight, excessive dust, or vibration.
- Install the System in a location with adequate ventilation to prevent internal heat buildup.

Power cord

- Do not handle the power cord with wet hands.
- A small amount of power is always consumed while the power cord is connected to the wall outlet.
- Do not pull on the cord to unplug the power cord. When unplugging the power cord, always grasp and pull the plug so as not to damage the cord.

To prevent malfunctions of the System

- There are no user-serviceable parts inside. If anything goes wrong, unplug the power cord and consult your dealer.
- Do not insert any metallic objects or liquids into the System.

Safety precautions

Avoid moisture, water, and dust

Do not place the System in moist or dusty places.

Avoid high temperatures

Do not expose the System to direct sunlight and do not place it near any heating devices.

When you are away

When away on holiday or for other reasons for an extended period of time, disconnect the power cord from the wall outlet.

Do not block the vents

Blocking the vents may damage the System.

Care of the cabinet

- Stains on the System should be wiped off with a soft cloth. If the System is heavily stained, wipe it with a cloth soaked in water diluted neutral detergent and wrung well, then wipe clean with a dry cloth.
- Since the System may deteriorate in quality, become damaged or get its paint peeled off, be careful about the following:
 - DO NOT wipe it forcefully.
 - DO NOT wipe it with thinners, benzines or other organic solvents including disinfectants.
 - DO NOT apply any volatile substances such as insecticides to it.
 - DO NOT allow any rubber or plastic to remain in contact with it for a long time.
- Do not place anything on top of the System. Doing so may cause the System to fall, causing malfunctioning and/or injury.
- The manufacturer accepts absolutely no liability for any accidents or damage resulting from inadequate assembly or mounting, insufficient strength of attachment, misuse or abuse, or natural disasters.

If water gets inside the System

Turn the System off and disconnect the power cord from the wall outlet, then call the store where you purchased this System. Using the System in this condition may cause a fire or electrical shock.

Supplied accessories

Check to make sure you have all of the supplied accessories.

If anything is missing, contact your dealer immediately.

- Remote control RM-STHBA3A (× 1)
- AC adaptor (AA-R1902) (× 2)
- AC plug adaptor (× 3)
- AC power cord (× 2)
- Lithium coin battery CR2025 (× 1)
 - The battery has been installed in the remote control when shipped from the factory.
- Core filter (large) (× 3)
 - For the DC power cord and external components cords
- Core filter (small) (× 1)
 - For surround speaker cords

CAUTION: Proper Ventilation

To avoid risk of electric shock and fire, and to prevent damage, locate the apparatus as follows:

- Front: No obstructions and open spacing.
- Sides/Top/Back: No obstructions should be placed in the areas shown by the dimensions below.
- Bottom: Place on the level surface. Maintain an adequate air path for ventilation by placing on a stand with a height of 10 cm or more.

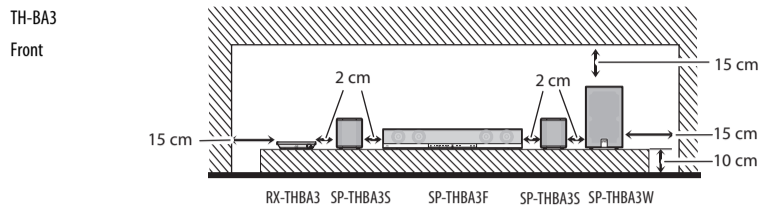

Mains (AC) Line Instruction

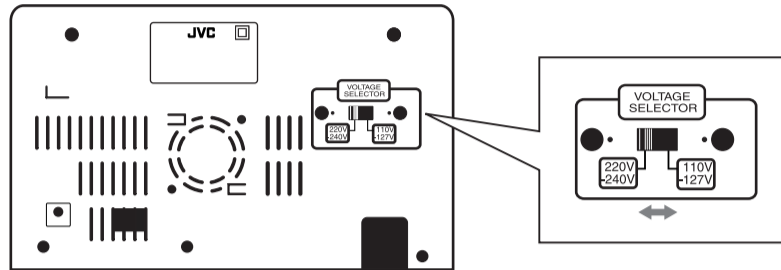

CAUTION for mains (AC) line

BEFORE PLUGGING IN, do check that your mains (AC) line voltage corresponds with the position of the voltage selector switch provided on the outside of this equipment and, if different, reset the voltage selector switch, to prevent from damage or risk of fire/electric shock.

For SP-THBA3F, RX-THBA3, SP-THBA3S and SP-THBA3W

This device complies with RSS-210 of Industry Canada Rules. Operation is subject to the following two conditions: (1) this device may not cause interference, and (2) this device must accept any interference, including interference that may cause undesired operation of the device.

For SP-THBA3F, RX-THBA3, SP-THBA3S and SP-THBA3W

This device complies with Part 15 of the FCC Rules. Operation is subject to the following two conditions: (1) This device may not cause harmful interference, and (2) this device must accept any interference received, including interference that may cause undesired operation. Changes or modifications not expressly approved by the manufacturer for compliance could void the user's authority to operate the equipment.

Specifications

Center unit (SP-THBA3F)

Output power

Center/ Front Surround: **120 W (30 W × 4), at 4 Ω (THD 10 %)**

Audio section

Analog Input: ANALOG: 1 Vrms/50 kΩ
 Digital Input*: DIGITAL 1, DIGITAL 2: -21 dBm to -15 dBm (660 nm ±30 nm)

Speaker section

Type: Full-Range Bass-Reflex Type (Magnetically-Shielded Type)
 8 cm cone × 4
 Speaker: 30 W
 Power Handling Capacity: 4 Ω
 Impedance: 4 Ω
 Frequency Range: Center Speakers: 84 Hz to 22 kHz
 Front Speakers: 84 Hz to 22 kHz
 Center Speakers: 82 dB/W·m
 Front Speakers: 82 dB/W·m

Sound Pressure Level:

General

Power Source (DC IN): DC19V \approx 3.37 A
 AC adaptor (AA-R1902): Input: AC 110-240 V \sim 1.5-0.9 A, 50/60 Hz
 Output: DC19V \approx 3.37 A
 Dimensions (W × H × D): 900 mm × 125 mm × 85 mm
 Mass: 3.5 kg

Powered subwoofer (SP-THBA3W)

Output power

100 W, RMS at 3 Ω at 45 Hz, with 10% total harmonic distortion
 Type: 1-Way Bass-Reflex Type
 Speaker: 16 cm cone × 1
 Power Handling Capacity: 100 W
 Impedance: 3 Ω
 Frequency Range: 45 Hz to 5 kHz
 Sound Pressure Level: 82 dB/W·m
 Power Requirements: AC 110 - 127 V/220 - 240 V \sim , adjustable with the voltage selector
 50/60 Hz

Power Consumption:

30 W (during operation)
 1.00 W or less (in Standby mode)
 Dimensions (W × H × D): 215 mm × 352 mm × 254 mm
 Mass: 5 kg

Wireless receiver unit (RX-THBA3)

Output power:

30 W per channel, RMS at 4 Ω at 1 kHz, with 10% total harmonic distortion

Power Source (DC IN): DC19V \approx 3.37 A
 AC adaptor (AA-R1902): Input: AC 110 - 240 V \sim 1.5-0.9 A, 50/60 Hz
 Output: DC 19V \approx 3.37 A
 Dimensions (W × H × D): 186 mm × 30.8 mm × 300 mm
 Mass: 0.53 kg

Surround speaker (SP-THBA3S)

Type: Full-Range Bass-Reflex Type
 Speaker: 8 cm cone × 1
 Power Handling Capacity: 30 W
 Impedance: 4 Ω
 Frequency Range: 84 Hz to 22 kHz
 Sound Pressure Level: 82 dB/W·m
 Dimensions (W × H × D): 105 mm × 118 mm × 98 mm
 Mass: 0.46 kg each

* Corresponding to Linear PCM, Dolby Digital, and DTS (with sampling frequency — 32 kHz, 44.1 kHz, 48 kHz)

Designs & specifications are subject to change without notice.

Getting started

DO NOT connect the power cord until all other connections have been made.

Prepare the Remote Control

When you use the remote control for the first time, pull out the insulation sheet.

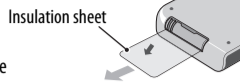

If the range or effectiveness of the remote control decreases, replace the battery.

To Replace the Battery in the Remote Control

Insert the battery into the remote control by matching the polarities (+ and -) correctly.

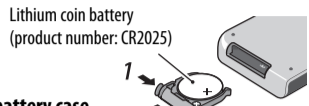

1 Pinch the side of the battery case.

2 Pull out the battery case and insert the battery by matching the polarities.

NOTE

- Store the battery in a place where children cannot reach. If a child accidentally swallows the battery, consult a doctor immediately.

- To prevent the battery from overheating, cracking, or starting a fire:
 - Do not recharge, short, disassemble or heat the battery, or dispose of it in a fire.
 - Do not leave the battery with other metallic materials.
 - Wrap the battery with tape and insulate when throwing away or saving it.
- Do not poke the battery with tweezers or similar tools.
- Dispose of the battery in the proper manner, according to federal, state, and local regulations.

CAUTION:

Danger of explosion if battery is incorrectly replaced. Replace only with the same or equivalent type.

Speaker layout

Install the speakers on a flat and level surface to ensure the best sound quality.

- The sound may be affected depending on the location in which you install them. To avoid such issues, change the location and orientation of the speakers.
- Install the speakers leaving an appropriate distance between them.
- If you install the speakers near the TV, color distortion may occur. To prevent this, turn off the TV's main power or unplug it before installing the speakers. Wait at least 30 minutes before turning on the TV's main power again.
- If the TV is still affected, move the speakers further away.

Connect the wireless receiver unit to the surround speakers.

NOTE

- To obtain the best possible sound from the System, install all speakers except the subwoofer at the same distance from the listening position. See the typical installation next.
- If your speakers cannot be installed at the same distance from the listening position, you can adjust the speaker distance of each speaker by remote control. See "Adjusting the speaker distance" below.

Typical installation

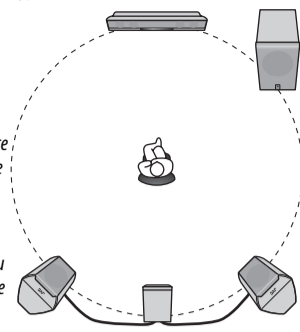

Installing on the wall

You can install the center unit and surround speakers on the wall.

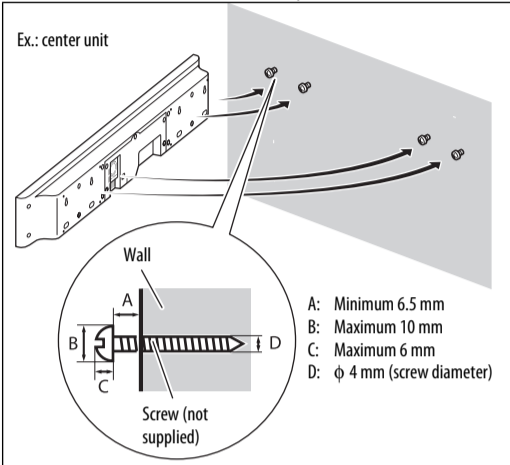

CAUTION

- The center unit weighs approximately 3.5 kg and the surround speakers weigh approximately 0.6 kg each. Sufficient care must be taken when installing them on the wall to prevent any accidents caused by their falling off.
- Use screws which are compatible with the strength and material of the pillar or wall to prevent the center unit and surround speakers from falling off.
- Do not install the center unit and surround speakers onto a plywood or plasterboard wall; otherwise, they will fall and sustain damage.
- When installing the center unit and surround speakers on the wall:
 - Be sure to have them installed on the wall by qualified personnel.
 - Care must be taken when selecting a location for installation on the wall. Injury to personnel or damage to equipment may result if the installed units interfere with daily activities.
 - AC adaptor should not be hanging/put above of any other items. It is acceptable to place the AC adaptor on the flat floor only.
 - Recommended mounting surface: Wooden studs. If the mount is to be installed on any surface other than wooden studs, use suitable hardware (which is commercially available).

Attaching speaker stands

You can use the speaker stands (not supplied) for installation.

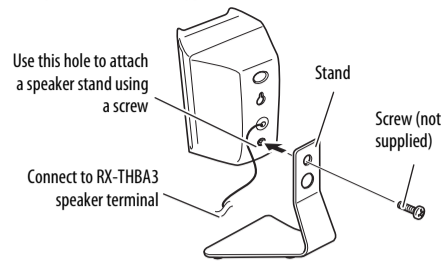

NOTE

- When attaching a speaker stand, refer to the instructions of the speaker stands you purchased.
- Refer to the supplied information sheet for wire arrangement and containing the speaker cords.

CAUTION

- Do not install the surround speakers in a place where they may interfere with daily activities. Injury to personnel or damage to equipment may result if the surround speakers are installed in such a place.

Connecting external components

You can connect analog components to the ANALOG terminal and digital components to the DIGITAL 1 and DIGITAL 2 terminals.

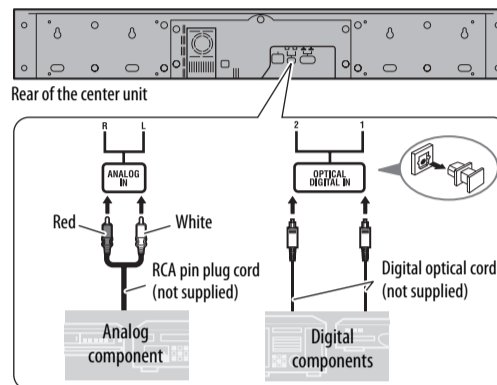

Connecting the power cord

Connect the supplied AC adaptor to the DC IN jacks on the center unit and wireless receiver unit. Then connect the supplied AC power cord to the AC adaptor, and plug it in a wall outlet.

- Plug in the power cord of the subwoofer to a wall outlet.

CAUTION

- Disconnect the power cords before cleaning or moving the speakers.

Using the core filter

Attach the provided core filter to the power cord and the external components cord to reduce interference.

1 Release the stopper of the core filter.



2 Run the cable through the core filter, and wind the cable firmly once inside the cutout of the core filter as shown in the illustration.

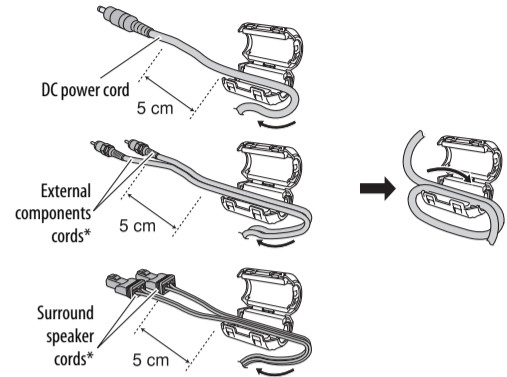

* You can wind two external components cords or surround speaker cords together.

3 Close the core filter until it clicks shut.

CAUTION

- Do not damage the cord by applying excessive force when winding.

Setting up the subwoofer and wireless receiver unit

This System is equipped with a wireless subwoofer and receiver unit. When you use them for the first time, activate the wireless pairing. Refer to the supplied information sheet—"Activate wireless pairing."

NOTE

- The wireless pairing is not canceled even after the AC plug has been pulled out.



Operations



Basic operation

Turning on/off the power

Press **1**.

- You can also use the power button on the front panel.

NOTE

- A small amount of power is consumed even when the power is turned off (standby mode). During standby mode, the STANDBY lamp on the front panel lights up. Unplug the power cord from the AC outlet to turn the power off completely.
- You can also turn on the System by pressing one of the input buttons (DIGITAL 1, DIGITAL 2 or ANALOG).

Selecting the input source

Press one of the input buttons: DIGITAL 1, DIGITAL 2 or ANALOG.

D1 (DIGITAL 1), **D2** (DIGITAL 2) or **AN** (ANALOG) appears on the display for 2 seconds.

- You can also use the input button on the front panel.

NOTE

- The indicator lamp of the selected input source lights.

Adjusting the volume

Press **VOLUME +/-** (0 to 40).

- You can also use the volume buttons on the front panel.

CAUTION

- Set the volume to the minimum level before starting any input source. If the volume is set to a high level, the sudden blast of sound may damage your hearing and blow out the speakers.

Turning off the sound temporarily

Press **FADE MUTING**.

- To restore the sound, press the button again or adjust the volume.

Changing the display brightness

Press **DIMMER**.

Each time you press the button, the LED brightness changes as follows: normal → dim → off

Making sound clearer (Only for Dolby Digital and DTS)

You can enjoy low level recorded sound clearly even at a low volume level—Dynamic Range Compression.

Press **DRC**.

Each time you press the button, the sound is enhanced the effect as follows: OF(off) → MD (middle) → MX (maximum)

Buttons and lamps on the front panel

- 1** **Power button and STANDBY lamp**
Turns on/off the System.
• STANDBY lamp lights up while the System is turned off.
- 2** **Input button and input source indicator lamps**
Selects an input source: "DIGITAL 1," "DIGITAL 2" or "ANALOG."
• The indicator lamp for the selected input source lights up.

Adjusting the output level of the speakers

You can adjust the output level within the range of -6 dB to +6 dB.

1 Press **SPK LEVEL** ch repeatedly to select the target speaker.

Each time you press the button, the speaker changes as follows:

FL (Front left surround speaker) → **CT** (Center speaker) → **FR** (Front right surround speaker) → **SR** (Surround right speaker) → **SL** (Surround left speaker) → **SW** (Subwoofer) → Back to the beginning

2 Press **SPK LEVEL +/-** to adjust the output level while the indication is displayed.

Using the surround mode

You can listen to a more realistic sound than stereo sound using surround. Available surround modes are as follows:

- SURROUND 1:** Suitable for the reproduction of multi-channel sources. **S1** appears on the display when selected.
- SURROUND 2:** Suitable for the reproduction of any stereo music sources. **S2** appears on the display when selected.

- The indicator lamp of the selected mode lights.

Press **SURROUND MODE** repeatedly to select the desired mode.

The surround mode changes alternately.

- To deactivate, press **OFF**. **OF** appears on the display.

Adjusting the speaker distance

By adjusting the speaker distance, you can enjoy the optimum surround sound even if it is hard to install the speakers as shown in the typical installation above.

1 Press **DISTANCE** ch repeatedly to select the desired speaker.

The speaker channel has been changed in the following sequence:

FT (Front speaker) → **SL** (Surround left speaker) → **SR** (Surround right speaker) → **SW** (Subwoofer) → Back to the beginning

2 Press **DISTANCE +/-** to adjust the distance from the listening position to the selected speaker.

- For the example below, set the speaker distance as follows:

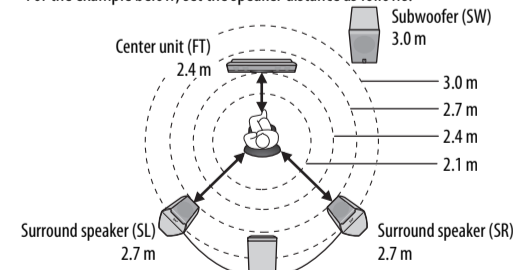

- You can adjust the speaker distance from 0.3 m to 9.0 m. Each time you press the button, the distance changes by 0.3 m.

Listening to the test tone

Press **TEST TONE** to monitor the test tone.

The test tone comes out of the speakers in the following sequence:

FL (Front left surround speaker) → **CT** (Center speaker) → **FR** (Front right surround speaker) → **SR** (Surround right speaker) → **SL** (Surround left speaker) → Back to the beginning

No test tone comes out of the subwoofer.

- Press **SPK LEVEL +/-** to adjust the output level while monitoring the test tone of these speakers.
- To stop monitoring the test tone, press **TEST TONE**.

Troubleshooting

If you have a problem with this System, check this list for a possible solution before calling for service.

POWER

Power does not come on.

- The power cord is not inserted securely. Plug it in securely.

REMOTE CONTROL

The remote control does not work.

- The battery is exhausted. Replace the battery.
- Sunlight is shining directly on the remote sensor. Hide the remote sensor from direct sunlight.
- The path between the remote control and the remote sensor on the front panel is blocked.
- Point the remote control at the remote sensor on the front panel.
- Signals cannot reach the remote sensor. Move closer to the unit.
- Pull out the insulation sheet.

SOUND

Sounds are sometimes interrupted.

- Radio wave connections may be interrupted. Change the location and orientation of the speakers.

No sound from speakers.

- The wireless connections have not been activated correctly. Check the connection.
- The sound has been turned off temporarily. Press **FADE MUTING** on the remote control or adjust the volume by pressing **VOLUME +/-**.

Radio wave reflections

The System is connected directly by radio waves which are reflected by walls, furniture and buildings. If the System cannot receive the waves properly, move the System to obtain better reception. Radio wave reception may also be interrupted by people moving between the units.