

JVC



DVD DIGITAL CINEMA SYSTEM

TH-S33

Consists of XV-THS33, SP-WS33, SP-THS33F,
SP-THS33C and SP-THS33S

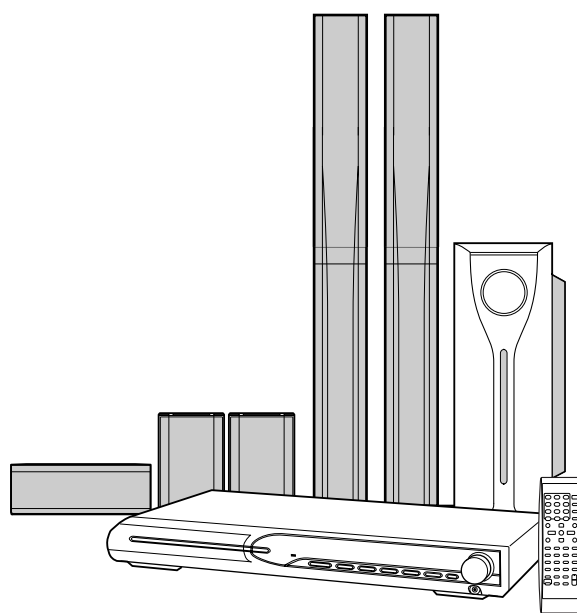

TH-S11

Consists of XV-THS11, SP-WS11, SP-THS11F,
SP-THS11C and SP-THS11S

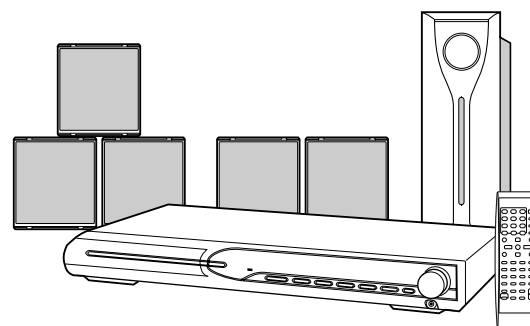

INSTRUCTIONS

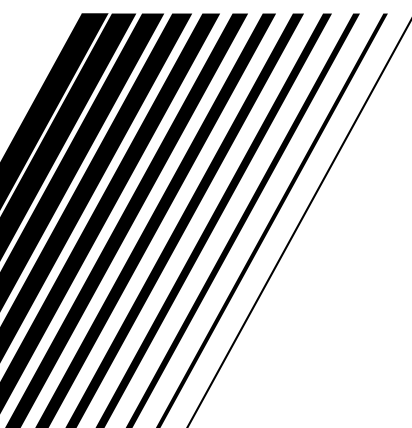

Warnings, Cautions and Others

IMPORTANT for the U.K.

DO NOT cut off the mains plug from this equipment. If the plug fitted is not suitable for the power points in your home or the cable is too short to reach a power point, then obtain an appropriate safety approved extension lead or consult your dealer.

BE SURE to replace the fuse only with an identical approved type, as originally fitted.

If nonetheless the mains plug is cut off ensure to remove the fuse and dispose of the plug immediately, to avoid a possible shock hazard by inadvertent connection to the mains supply.

If this product is not supplied fitted with a mains plug then follow the instructions given below:

IMPORTANT.

DO NOT make any connection to the terminal which is marked with the letter E or by the safety earth symbol or coloured green or green-and-yellow.

The wires in the mains lead on this product are coloured in accordance with the following code:

Blue: Neutral
Brown: Live

As these colours may not correspond with the coloured markings identifying the terminals in your plug proceed as follows:

The wire which is coloured blue must be connected to the terminal which is marked with the letter N or coloured black.

The wire which is coloured brown must be connected to the terminal which is marked with the letter L or coloured red.

IF IN DOUBT - CONSULT A COMPETENT ELECTRICIAN.

CAUTION

To reduce the risk of electrical shocks, fire, etc.:

1. Do not remove screws, covers or cabinet.
2. Do not expose this appliance to rain or moisture.

CAUTION— ϕ /I button!

Disconnect the mains plug to shut the power off completely (the STANDBY lamp goes off).

The ϕ /I button in any position does not disconnect the mains line.

- When the system is on standby, the STANDBY lamp lights red.
- When the system is turned on, the STANDBY lamp goes off. The power can be remote controlled.

CAUTION

- Do not block the ventilation openings or holes. (If the ventilation openings or holes are blocked by a newspaper or cloth, etc., the heat may not be able to get out.)
- Do not place any naked flame sources, such as lighted candles, on the apparatus.
- When discarding batteries, environmental problems must be considered and local rules or laws governing the disposal of these batteries must be followed strictly.
- Do not expose this apparatus to rain, moisture, dripping or splashing and that no objects filled with liquids, such as vases, shall be placed on the apparatus.

IMPORTANT FOR LASER PRODUCTS

1. CLASS 1 LASER PRODUCT
2. **CAUTION:** Do not open the top cover. There are no user serviceable parts inside the unit; leave all servicing to qualified service personnel.
3. **CAUTION:** Visible and invisible laser radiation when open and interlock failed or defeated. Avoid direct exposure to beam.
4. REPRODUCTION OF LABEL: CAUTION LABEL, PLACED INSIDE THE UNIT.

CAUTION : Visible and invisible laser radiation when open and interlock failed or defeated. AVOID DIRECT EXPOSURE TO BEAM. (e)	ADVARSEL : Synlig og usynlig laserstråling når maskinen er åben eller interlocken fejler. Undgå direkte eksponering til stråling. (d)	WARNING : Synlig och osynlig laserstrålning när den öppnas och spärren är urkopplad. Betrakta ej strålen. (s)	VARO : Avattaessa ja suojalukitus ohitettuna tai viallisena olet alttiina näkyvälle ja näkymättömälle lasersäteilylle. Vältä säteen kohdistumista suoraan itseesi. (f)
---	--	--	---

Caution: Proper Ventilation

To avoid risk of electric shock and fire and to protect from damage, place the apparatus on a level surface. The minimal clearances are shown below:

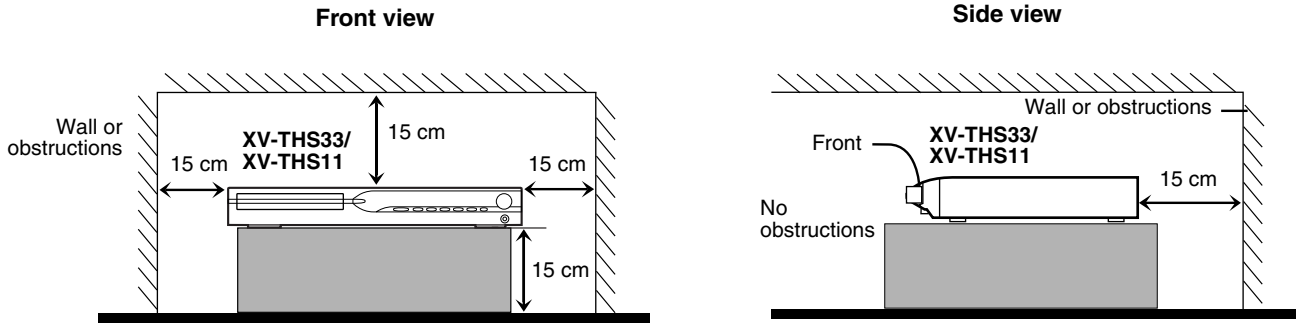

SAFETY INSTRUCTIONS

“SOME DOS AND DON'TS ON THE SAFE USE OF EQUIPMENT”

This equipment has been designed and manufactured to meet international safety standards but, like any electrical equipment, care must be taken if you are to obtain the best results and safety is to be assured.

Do read the operating instructions before you attempt to use the equipment.

Do ensure that all electrical connections (including the mains plug, extension leads and interconnections between pieces of equipment) are properly made and in accordance with the manufacturer's instructions. Switch off and withdraw the mains plug when making or changing connections.

Do consult your dealer if you are ever in doubt about the installation, operation or safety of your equipment.

Do be careful with glass panels or doors on equipment.

DON'T continue to operate the equipment if you are in any doubt about it working normally, or if it is damaged in any way — switch off, withdraw the mains plug and consult your dealer.

DON'T remove any fixed cover as this may expose dangerous voltages.

DON'T leave equipment switched on when it is unattended unless it is specifically stated that it is designed for unattended operation or has a standby mode.

Switch off using the switch on the equipment and make sure that your family know how to do this. Special arrangements may need to be made for infirm or handicapped people.

DON'T use equipment such as personal stereos or radios so that you are distracted from the requirements of traffic safety. It is illegal to watch television whilst driving.

DON'T listen to headphones at high volume as such use can permanently damage your hearing.

DON'T obstruct the ventilation of the equipment, for example with curtains or soft furnishings. Overheating will cause damage and shorten the life of the equipment.

DON'T use makeshift stands and NEVER fix legs with wood screws — to ensure complete safety always fit the manufacturer's approved stand or legs with the fixings provided according to the instructions.

DON'T allow electrical equipment to be exposed to rain or moisture.

ABOVE ALL

—NEVER let anyone, especially children, push anything into holes, slots or any other opening in the case — this could result in a fatal electrical shock.;

—NEVER guess or take chances with electrical equipment of any kind — it is better to be safe than sorry!

E43486-340B

Table of contents

Introduction	2
Notes on handling	2
Supplied accessories	2
About discs	3
Playable disc types	3
Index of parts and controls	5
Connections	7
Connecting the FM and AM (MW) antennas	7
Connecting the satellite (front, center, surround) speakers and the subwoofer	8
Speaker layout	11
Connecting a TV	11
Connecting the power cord	11
Operating the TV	12
Basic operations	13
Turning the system on/off	13
Selecting the source to play	14
Adjusting the volume [VOLUME]	14
Listening with headphones (not supplied)	14
Turning off the sound temporarily [MUTING]	14
Adjusting the brightness of the indications [DIMMER]	14
Sleep Timer [SLEEP]	15
Adjusting the output level of the front/center/surround speakers and subwoofer	15
Adjusting the sound	15
Changing the video signal	15

Playback	16
Basic Playback	16
One Touch Replay	18
Fast-forward/fast-reverse search	18
Skip to the beginning of a desired selection	18
Locating a desired title/group using number buttons	19
Selecting the desired title/playlist from the control display	19
Advanced operations	20
Using the surround mode	20
Using the on-screen bar	21
Playing from a specified position on a disc	23
Using the file control display	24
Resume Playback	25
Selecting a view angle	25
Selecting the subtitle	26
Selecting the audio	26
Special picture playback	27
Program Playback	28
Random Playback	28
Repeat Playback	29
Tray lock	30
Balance Setting	30
Setting DVD preferences	31
Using the setup menus	31
Menu description	31
Tuner operations	34
Manual tuning	34
Preset tuning	34
Selecting the FM reception mode	35
Using the RDS (Radio Data System) when receiving FM stations	35
References	38
Maintenance	38
Troubleshooting	38
Specifications	39

Notes on handling

■ Important cautions

Installation of the system

- Select a place which is level, dry and neither too hot nor too cold; between 5°C and 35°C.
- Leave sufficient distance between the system and the TV.
- Do not use the system in a place subject to vibration.

Power cord

- Do not handle the power cord with wet hands!
- A small amount of power is always consumed while the power cord is connected to the wall outlet.
- When unplugging the power cord from the wall outlet, always pull on the plug, not the power cord.

To prevent malfunctions of the system

- There are no user-serviceable parts inside. If anything goes wrong, unplug the power cord and consult your dealer.
- Do not insert any metallic object into the system.
- Do not use any non-standard shape disc (like a heart, flower or credit card, etc.) available on the market, because it may damage the system.
- Do not use a disc with tape, stickers, or paste on it, because it may damage the system.

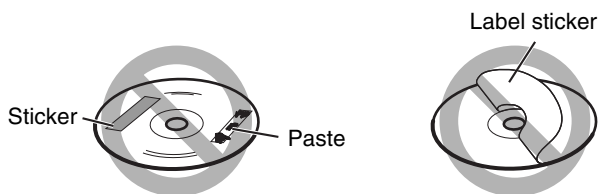

Note about copyright laws

Check the copyright laws in your country before recording from the discs. Recording of copyrighted material may infringe copyright laws.

Note about copyguard system

The discs are protected by copyguard system. When you connect the system to your VCR directly, the copyguard system activates and the picture may not be played back correctly.

■ Safety precautions

Avoid moisture, water and dust

Do not place the system in moist or dusty places.

Avoid high temperatures

Do not expose the system to direct sunlight and do not place it near a heating device.

When you are away

When away on travel or for other reasons for an extended period of time, disconnect the power cord plug from the wall outlet.

Do not block the vents

Blocking the vents may damage the system.

Care of the cabinet

When cleaning the system, use a soft cloth and follow the relevant instructions on the use of chemically-coated cloths. Do not use benzene, thinner or other organic solvents including disinfectants. These may cause deformation or discoloring.

If water gets inside the system

Turn the system off and disconnect the power cord plug from the wall outlet, then call the store where you made your purchase. Using the system in this condition may cause fire or electrical shock.

Supplied accessories

Check to be sure you have all of the supplied accessories.

The number in parentheses is the quantity of the pieces supplied. If anything is missing, contact your dealer immediately.

- Remote control (1)
- Batteries (2)
- FM antenna (1)
- AM loop antenna (1)
- Screws (for TH-S33)
M4 × 40 mm (6)

About discs

Playable disc types

This system has been designed to play back the following discs: DVD VIDEO, Video CD (VCD), Super Video CD (SVCD), Audio CD (CD), CD-R and CD-RW.

- This system accommodates the PAL system, and also can play discs recorded with NTSC system. Note that an NTSC video signal on a disc is converted to the PAL60 signal and output.
- This system can also play finalized DVD-R/-RWs recorded in DVD VIDEO format. However, some discs may not be played because of their disc characteristics or recording conditions.

Discs you can play:

DVD VIDEO 	Audio CD 
VCD 	SVCD 

- The following discs cannot be played back: CD-I (CD-I Ready), Photo CD, SACD, etc. Playing back these discs will generate noise and damage the speakers.
- The Non-DVD side of a “DualDisc” does not comply with the “Compact Disc Digital Audio” standard. Therefore, the use of Non-DVD side of a DualDisc on this product may not be recommended.
- **On some DVD VIDEOS, VCDs or SVCDs, their actual operation may be different from what is explained in this manual. This is due to the disc programming and disc structure, not a malfunction of this system.**

DVD Logo is a trademark of DVD Format/Logo Licensing Corporation.

Region code of DVD VIDEO

DVD VIDEO players and DVD VIDEO discs have their own Region Code numbers. This system can play back DVD VIDEO discs whose Region Code numbers include the system’s Region Code, which is indicated on the rear panel.

Example of playable DVD:



If a DVD with an improper Region Code number is loaded, “REGION CODE ERROR!” appears on the TV screen and playback cannot start.

Notes on DVD-R, DVD-RW and DVD-RAM

- This system can also play finalized DVD-Rs or DVD-RWs recorded in DVD VIDEO format and DVD-RWs or DVD-RAMs recorded in DVD VR format.
- This system can also play DVD-Rs or DVD-RWs if DivX, MP3 and JPEG files are recorded on them with UDF Bridge format. This system does not support “multi-border” disc.

Notes on CD-R and CD-RW

- This system can also play CD-Rs or CD-RWs if DivX, MP3 and JPEG files are recorded on them with ISO 9660 format.
- This system supports “multi-session” discs (up to 20 sessions).
- This system cannot play “packet write” discs.

Some discs may not be played back because of their disc characteristics, recording conditions, or damage or stain on them.

About discs

For all playable files

- The system can only recognize and play files with one of the following extensions, which can be in any combination of upper and lower case;
MP3: “.MP3”, “.mp3”
JPEG: “.JPG”, “.JPEG”, “.jpg”, “.jpeg”
DivX: “.DIVX”, “.DIV”, “.divx”, “.div”, and “.AVI”, “.avi”
- The system recognizes up to 150 tracks (files) per group, 99 groups per disc, and the total number of the tracks (files) that the system can play is 4000.
- Some files may not be played back normally because of their disc characteristics or recording conditions.
- MP3/JPEG/DivX discs require a longer readout time. (It differs due to the complexity of the directory/file configuration.)
- If different kinds of the file are mixed on a disc, set the FILE TYPE setting in the PICTURE menu to the appropriate setting for the data to be read (“AUDIO”, “STILL PICTURE” or “VIDEO”). (See page 32.)

Notes on MP3 files

- Tag information (album name, artist name, and track name) can be shown on the TV. (See page 24.)
- The system can play back the MP3 files recorded at 32 kbps to 320 kbps as a bit rate, and at 16 kHz, 22.05 kHz, 24 kHz, 32 kHz, 44.1 kHz and 48 kHz as a sampling frequency.
- We recommend to record each piece of material (song) at a sample rate of 44.1 kHz and at a data transfer rate of 128 kbps.

Notes on JPEG files

- We recommend to record a file at 640 x 480 resolution. (If a file has been recorded at a resolution of more than 640 x 480, it will take a longer time to be displayed.)
- This system can only play baseline JPEG files.

Notes on DivX files

- The system supports DivX 5.x, 4.x and 3.11.
- The system supports the DivX files whose resolution is 720 x 480 pixels or less (30 fps), and 720 x 576 pixels or less (25 fps).
- Audio stream should conform to MPEG 1 Audio Layer-2 or MPEG 1 Audio Layer-3 (MP3).
- The system does not support GMC (Global Motion Compression).
- The file encoded in the interlaced scanning mode may not be played back correctly.
- The system has its own Registration Code for DivX playback. If necessary, you can confirm the Registration Code of your system using the OTHERS menu. (See page 33.)
- “Official DivX Certified™ product”
“Plays DivX® 5, DivX® 4, DivX® 3, and DivX® VOD video content (in compliance with DivX Certified™ technical requirements)”
“DivX, DivX Certified, and associated logos are trademarks of DivXNetworks, Inc. and are used under license.”

This product incorporates copyright protection technology that is protected by U.S. patents and other intellectual property rights. Use of this copyright protection technology must be authorized by Macrovision, and is intended for home and other limited viewing uses only unless otherwise authorized by Macrovision. Reverse engineering or disassembly is prohibited.

Index of parts and controls

The numbers in the figures indicate the pages where the details of the parts are described.

Front panel (center unit)

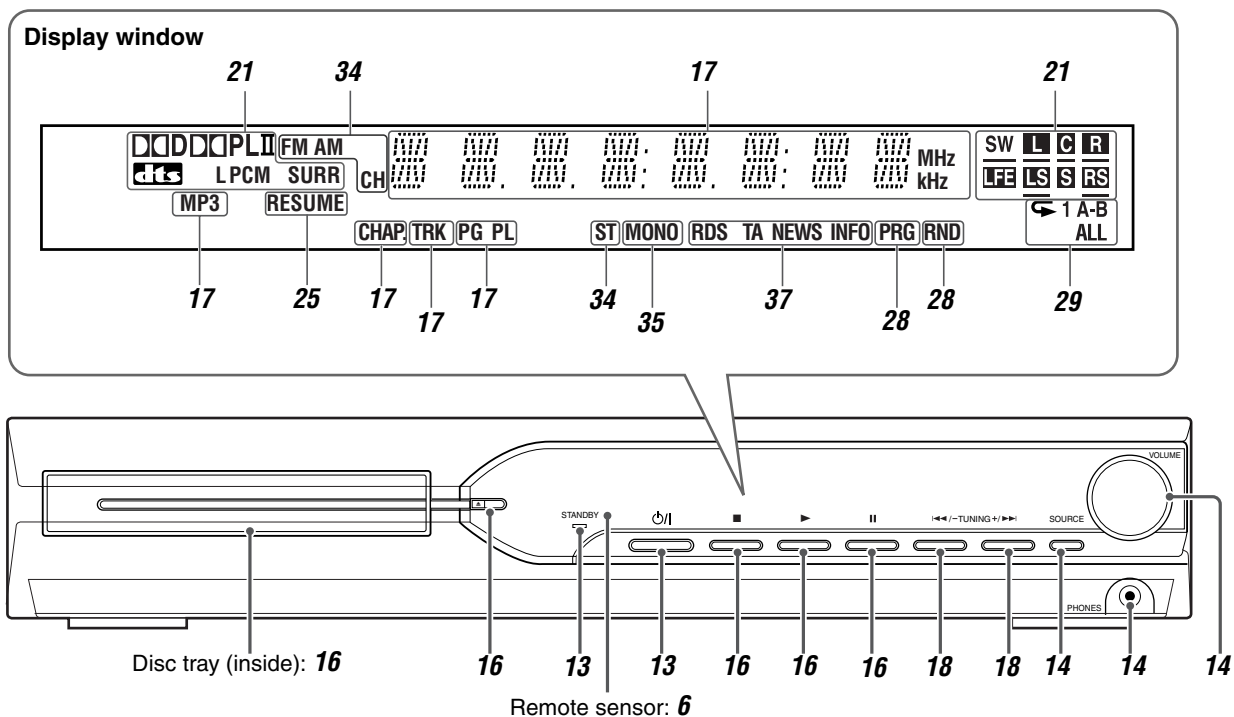

Rear panel (center unit)

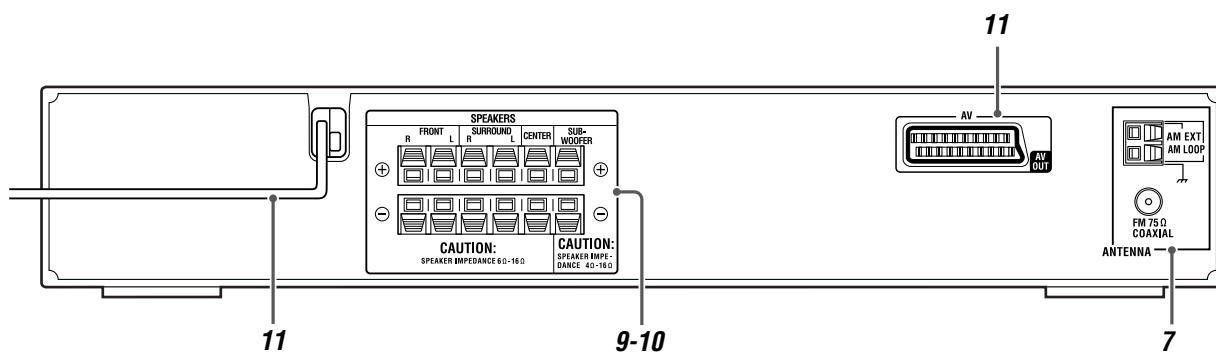

Remote control

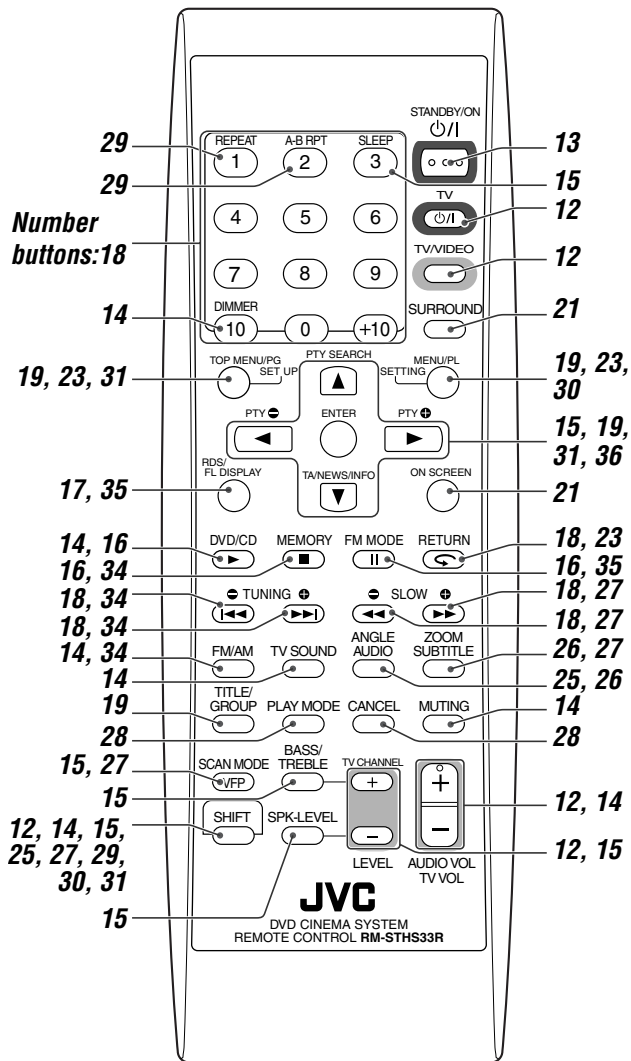

Putting batteries in the remote control

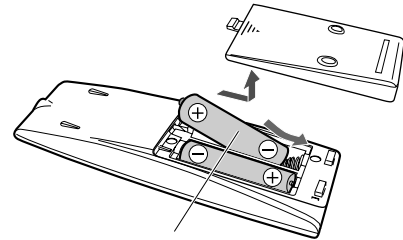

R6P (SUM-3)/AA (15F) type dry-cell batteries (supplied)

If the range or effectiveness of the remote control decreases, replace both batteries.

CAUTION

- Do not expose batteries to heat or flame.

Operating the system from the remote control

Aim the remote control directly to the front panel of the center unit.

- Do not hide the remote sensor.

Connecting the FM and AM (MW) antennas

■ AM (MW) loop antenna

Setting up supplied AM (MW) loop antenna

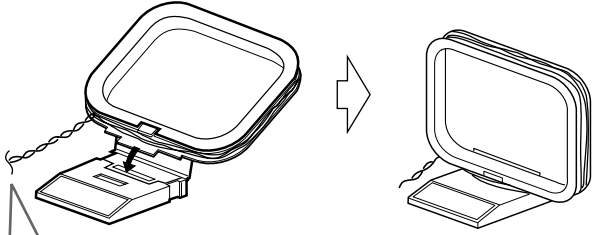

 If the antenna cord is covered with the insulation coat, twist and pull the insulation coat off and remove.

Connecting AM (MW) loop antenna

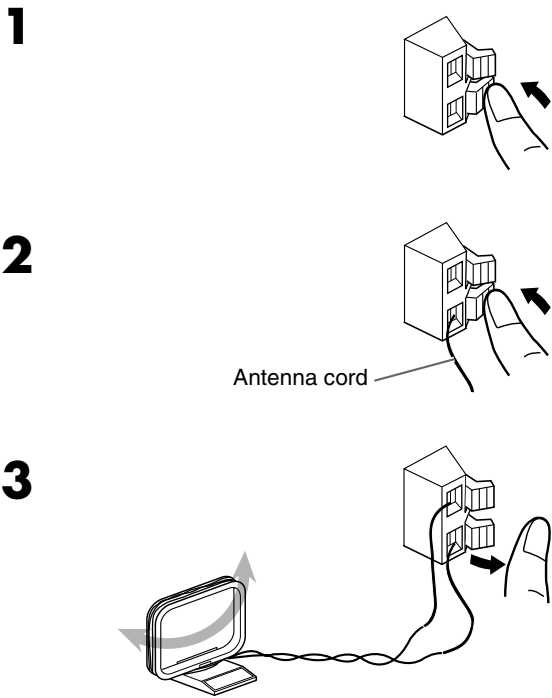

- Turn the loop antenna until you have the best reception during AM (MW) broadcast program reception.

NOTE

- Make sure the antenna conductors do not touch any other terminals, connecting cords and power cords. This could cause poor reception.

If reception is poor

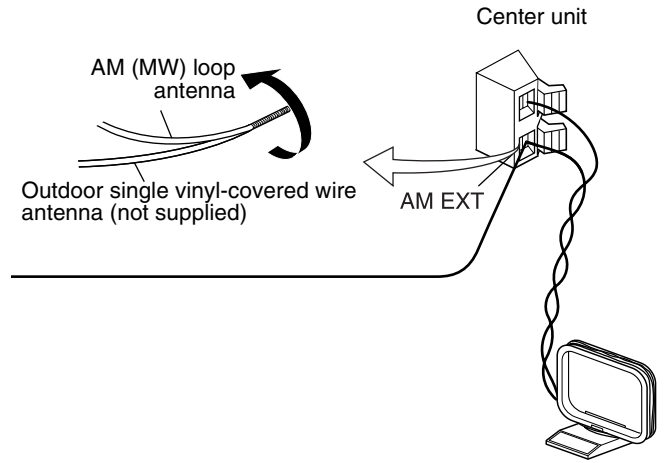

■ FM antenna

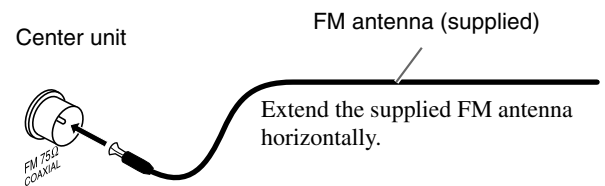

If reception is poor

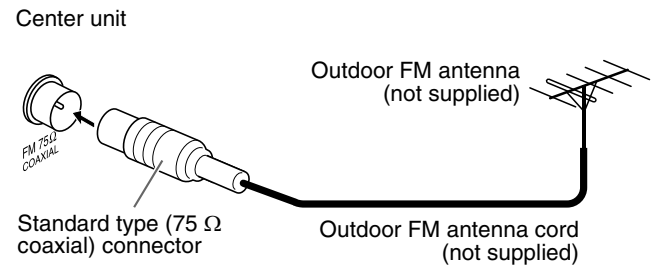

NOTE

- We recommend that you use coaxial cable for the FM antenna as it is well-shielded against interference.

Connecting the satellite (front, center, surround) speakers and the subwoofer

■ Assembling the front speakers for TH-S33

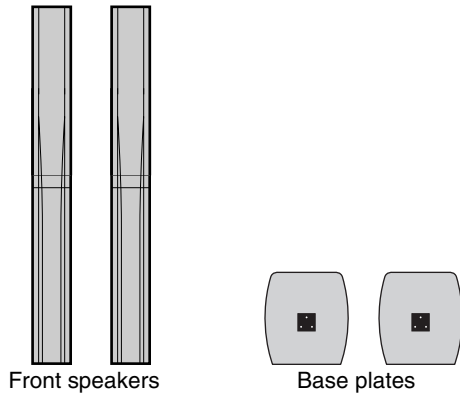

Precautions for daily use

- When moving the speakers, do not pull the speaker cords; otherwise, the speakers may fall over, causing damage or injury.
- When holding a speaker, always grasp the lower portion.
- Do not lean against the speakers, as the speakers could fall down or break, possibly causing an injury. Especially be careful that children do not lean against them.
- Do not reproduce sounds at so high a volume that they are distorted; otherwise, the speakers may be damaged by internal heat buildup.

Before assembling —

- Prepare a Phillips screwdriver (not supplied).
- Take care not to drop any component part while assembling; otherwise, it may cause damage to the floor or injury.

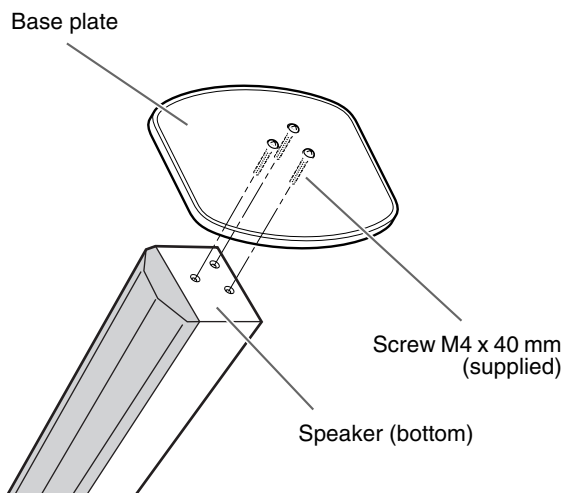

■ Connecting speakers for TH-S33

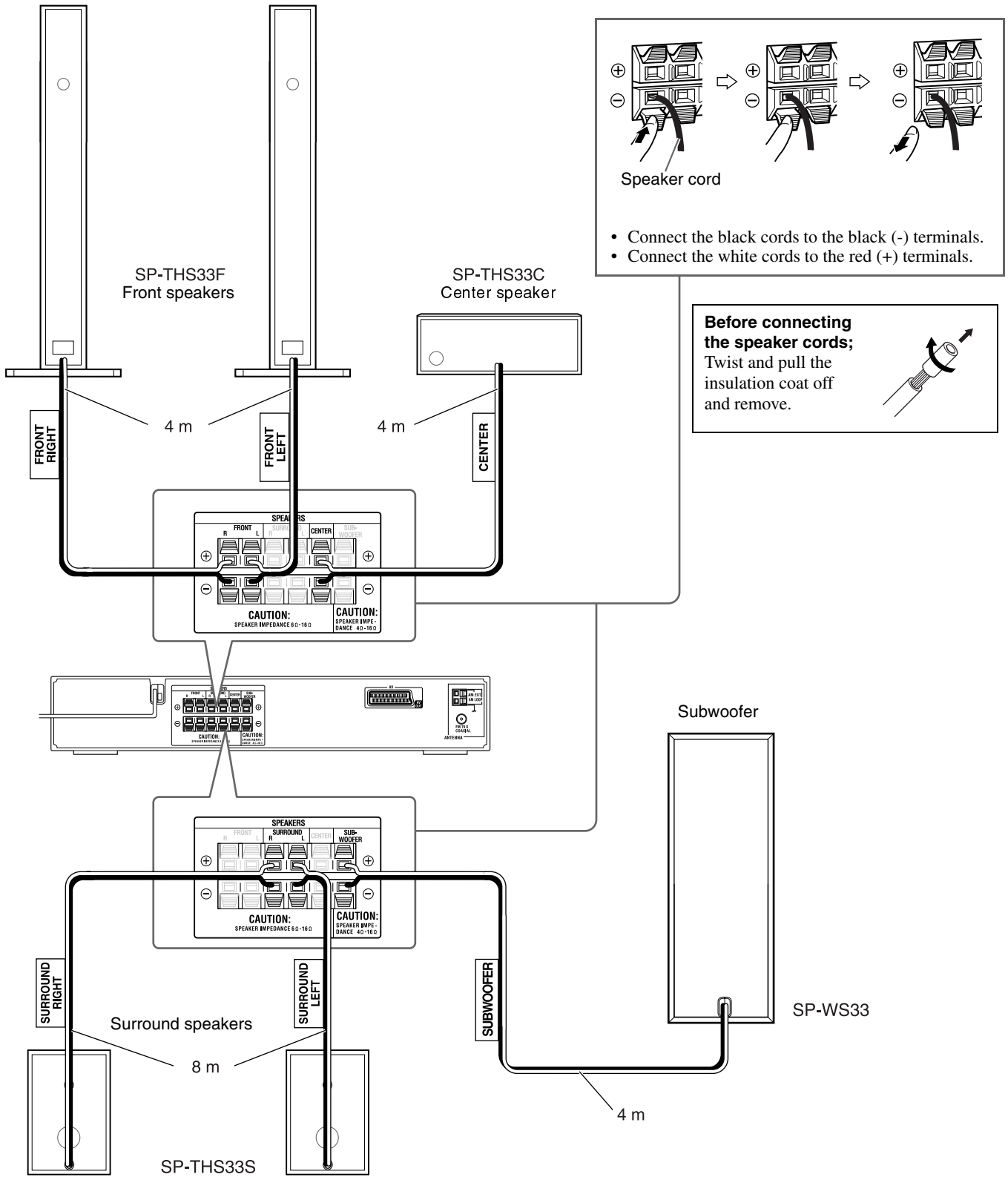

CAUTION

- When you connect speakers other than the supplied ones, use speakers of the same speaker impedance (SPEAKER IMPEDANCE) indicated on the rear of the center unit.
- DO NOT connect more than one speaker to one speaker terminal.

- When installing the satellite speakers on the wall;
 - Be sure to have them installed on the wall by a qualified personnel. DO NOT install the satellite speakers on the wall by yourself to avoid unexpected damage from their falling off the wall due to incorrect installation or weakness in wall structure.
 - Care must be taken in selecting a location for speaker installation on a wall. Injury to personnel or damage to equipment may result if the speakers installed interfere with daily activities.

■ Connecting speakers for TH-S11

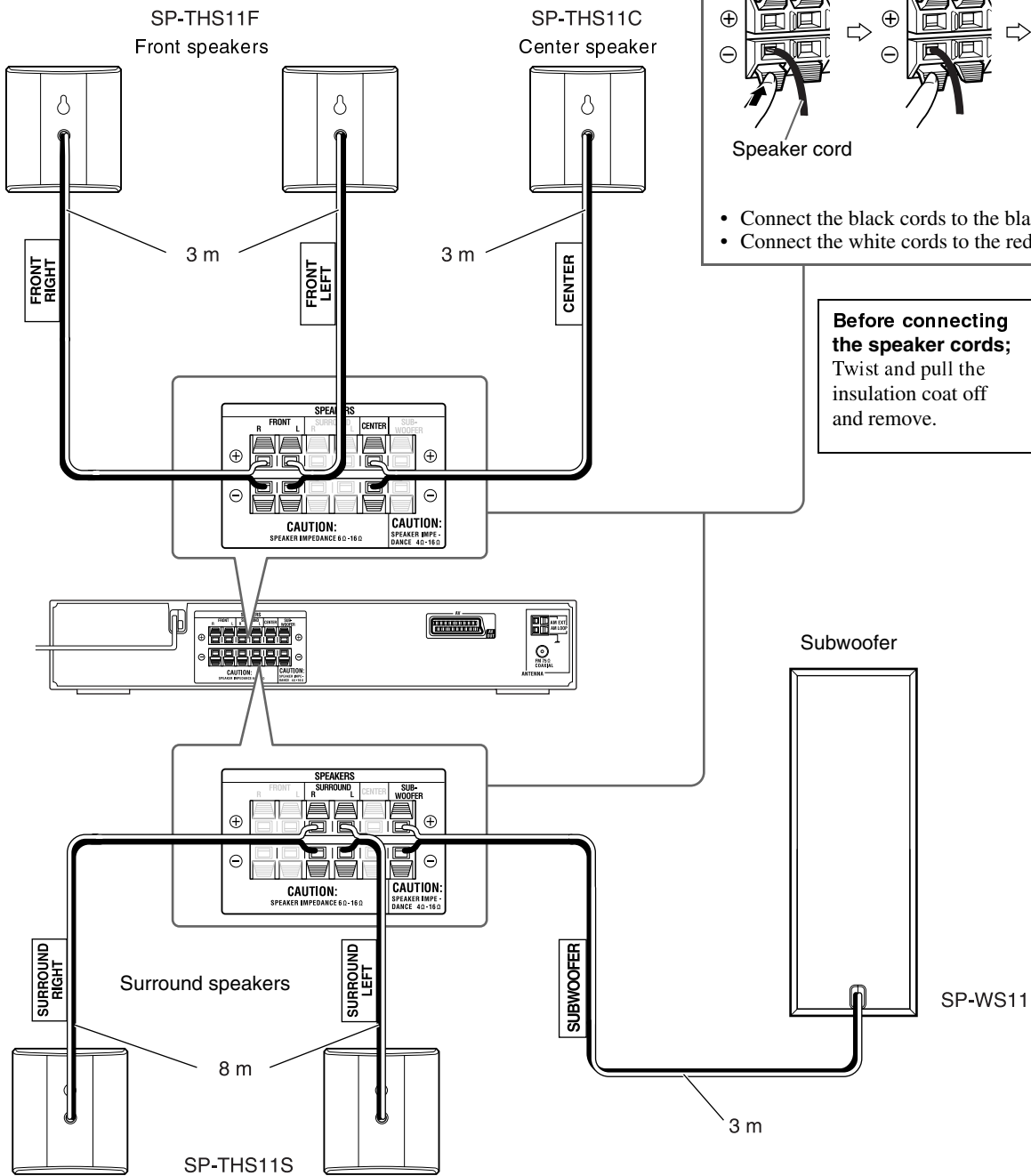

CAUTION

- When you connect speakers other than the supplied ones, use speakers of the same speaker impedance (SPEAKER IMPEDANCE) indicated on the rear of the center unit.
- DO NOT connect more than one speaker to one speaker terminal.

- When installing the satellite speakers on the wall;
 - Be sure to have them installed on the wall by a qualified personnel. DO NOT install the satellite speakers on the wall by yourself to avoid unexpected damage from their falling off the wall due to incorrect installation or weakness in wall structure.
 - Care must be taken in selecting a location for speaker installation on a wall. Injury to personnel or damage to equipment may result if the speakers installed interfere with daily activities.

Speaker layout

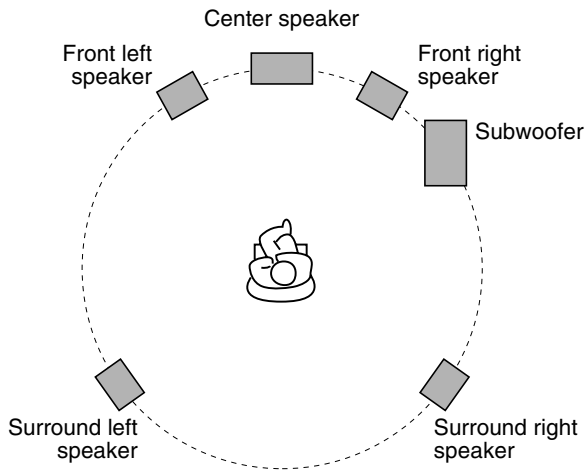

NOTE

- Place the satellite speakers on a flat and level surface.
- The front and center speakers are magnetically shielded to avoid color distortions on TVs. However, if not installed properly, they may cause color distortions. So, pay attention to the following when installing the speakers.
 - When placing the speakers near a TV set, turn off the TV's main power switch or unplug it before installing the speakers. Then wait at least 30 minutes before turning on the TV's main power switch again.
- Some TVs may still be affected even though you have followed the above. If this happens, move the speakers away from the TV.
- The surround speakers and the subwoofer are not magnetically shielded. If it is located nearby the TV or monitor, it will probably cause color distortion on the screen. To avoid this, do not place the speaker nearby the TV or monitor.
- Be sure to place the subwoofer to the TV's right. If you place the subwoofer to the TV's left, keep sufficient distance between them to prevent the TV screen from appearing mottled.

Connecting a TV

- Distortion of picture may occur when connecting the TV via a VCR, or to a TV with a built-in VCR.
- You need to set "MONITOR TYPE" in the PICTURE menu correctly according to the aspect ratio of your TV. (See page 32.)

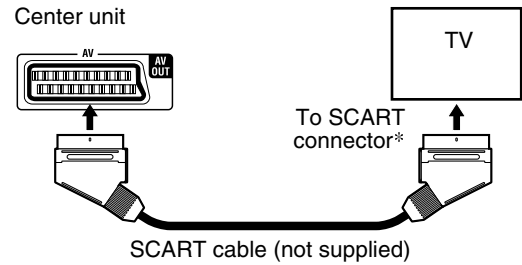

* Some TV's SCART connectors output audio signal. In such a case, you can enjoy the TV sound through this system.

NOTE

- No sound signal comes out from "AV" (SCART) connector.
- Select the appropriate video signal according to your TV. (See page 15.)

Connecting the power cord

Make sure that all other connections have been completed.

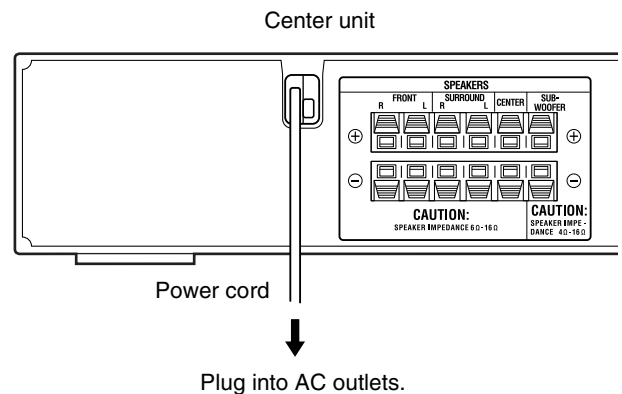

CAUTION

- Disconnect the power cord before cleaning or moving the system.
- Do not pull on the power cord to unplug the cord. When unplugging the cord, always grasp and pull the plug so as not to damage the cord.

NOTE

- Preset settings, such as preset stations and surround mode adjustment, may be erased in a few days in the following cases:
 - If you unplug the power cord of the center unit.
 - If a power failure occurs.

Operating the TV

You can use the remote control to operate not only this unit but also JVC's TV.

- Refer also to the manuals supplied for the TV.
- To operate the TV, aim the remote control directly at the remote sensor on the TV.

■ To operate a JVC's TV

You can perform the following operations on the TV.

TV \odot/I:	Turn on or off the TV.
TV VOL +/- with SHIFT pressed and held:	Adjust the volume.
TV/VIDEO:	Set the input mode (either TV or VIDEO).
CHANNEL +/- with SHIFT pressed and held:	Change the channels.

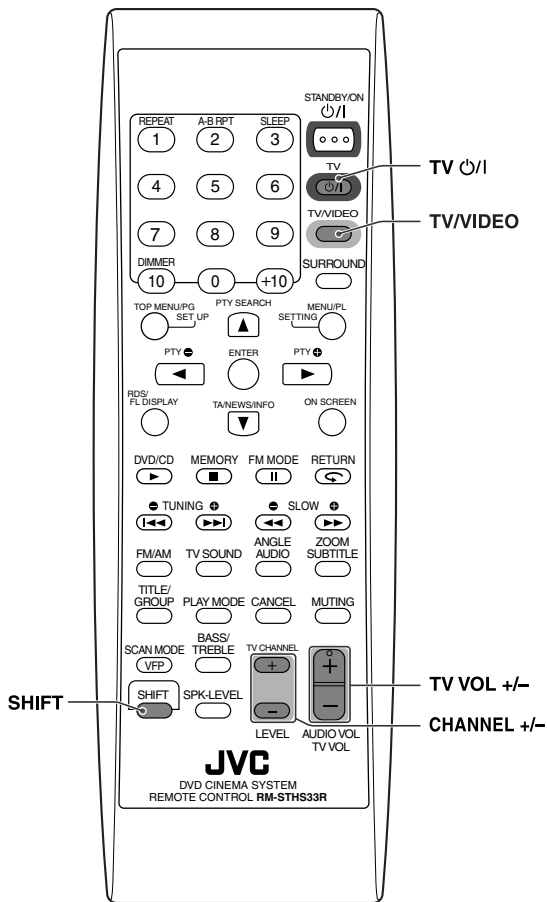

Basic operations

The buttons on the remote control are used to explain most of the operations in this manual. You can use the buttons on the center unit same as on the remote control for operations unless otherwise noted.

The buttons described below are used on pages 13 to 15.

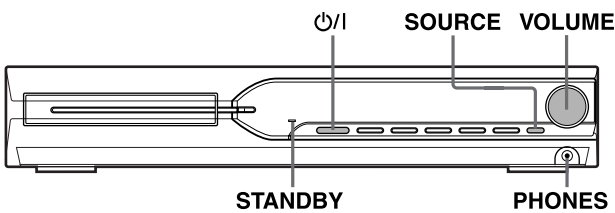
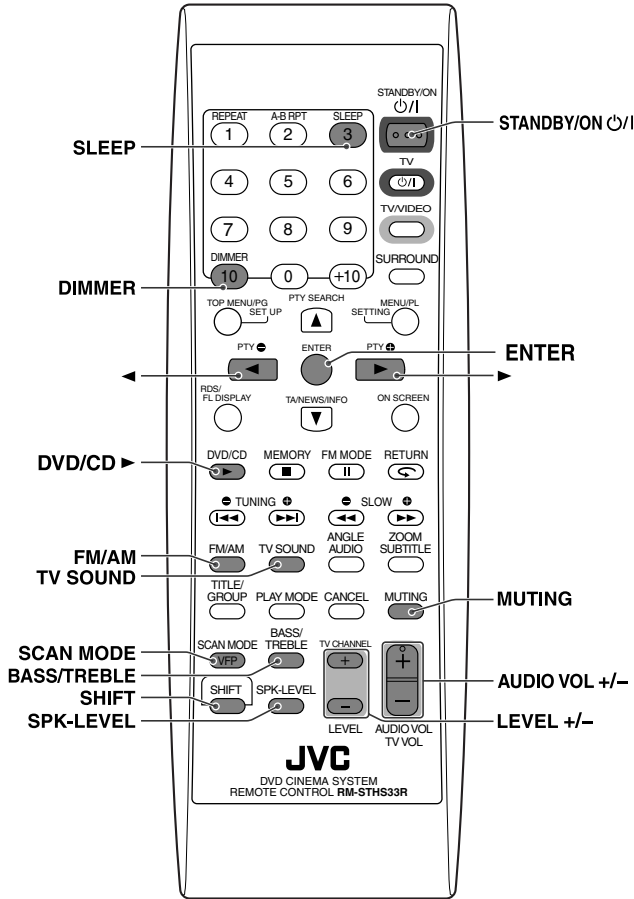

Turning the system on/off

On the remote control:

Press **STANDBY/ON** .

On the center unit:

Press .

When DVD is selected as the source (see page 14), the following messages will appear on the TV screen.

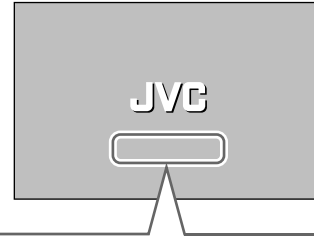

- “OPEN”/“CLOSE”:
Appears when opening or closing the disc tray.
- “NOW READING”:
Appears when the system is reading the disc information.
- “REGION CODE ERROR!”:
Appears when the Region Code of the DVD VIDEO does not match the code the system supports. The disc cannot be played back.
- “NO DISC”:
Appears when no disc is loaded.
- “CANNOT PLAY THIS DISC”:
Appears when unplayable disc is loaded.

NOTE

- The STANDBY lamp goes off when the power is turned on, and the lamp lights when the power is turned off.
- A small amount of the power is consumed even when the power is turned off. This is called standby mode and the STANDBY lamp lights in this mode. Unplug the power cord from the AC outlet to turn the power off completely.
- You can also turn on the system by pressing the following buttons;
 - ▲ on the center unit
 - One of the source selecting buttons on the remote control
 - ► on the center unit.

Selecting the source to play

On the remote control:

Press one of the source selecting buttons (DVD/CD▶, FM/AM or TV SOUND).

DVD/CD▶: To play back a disc (DVD VIDEO, VCD etc.). (See page 16.)

FM/AM: To tune in an FM or AM (MW) station. (See page 34.)

Each time you press the button, the band alternates between FM and AM (MW).

TV SOUND: To select the TV (that outputs sound signals) connected to the AV (SCART) connector. (See page 11.)

On the center unit:

Press SOURCE repeatedly until the source name you want appears on the display window.

NOTE

- When a source except DVD is selected, this system does not output video signals.
- It may take time to change the source.

Adjusting the volume [VOLUME]

CAUTION

- Always set the volume to minimum level before starting any source. If the volume is set at its high level, the sudden blast of sound could permanently damage your hearing and/or blow out the speakers.

On the remote control:

Press AUDIO VOL +/-.

On the center unit:

Turn VOLUME.

Listening with headphones (not supplied)

CAUTION

Be sure to turn down the volume;

- Before connecting or putting on headphones as high volume may damage both the headphones and your hearing.
- Before disconnecting headphones as high volume may be suddenly output from the speakers.

While connecting a pair of headphones to the PHONES jack on the center unit, the system automatically cancels the surround mode (see page 20) currently selected, deactivates the speakers, and activates the headphone mode. "H.PHONE" appears on the display window.

Headphone mode

When using the headphones, the following signals are output regardless of your speaker setting;

- For 2 channel sources, the front left and right channel signals are output from the headphones.
- Multi-channel signals are down-mixed and output from the headphones.

Turning off the sound temporarily [MUTING]

Press MUTING.

To restore the sound

Perform one on the following:

- Press MUTING again.
- Press AUDIO VOL +/- (or turn VOLUME on the center unit).

Adjusting the brightness of the indications [DIMMER]

Press DIMMER, with SHIFT pressed.

Each time you repeat the procedure, the brightness level changes.

Sleep Timer [SLEEP]

The system turns off automatically when the specified period of time has passed.

Press SLEEP, with SHIFT pressed.

Each time you repeat the procedure, the shut-off time changes.

Example:



To check the remaining time

Press SLEEP, with SHIFT pressed once.

To change the remaining time

Press SLEEP repeatedly, with SHIFT pressed.

To cancel

Press SLEEP repeatedly, with SHIFT pressed until "SLEEP - -" appears.

- Turning off the power also cancels the Sleep Timer.

Adjusting the output level of the front/center/surround speakers and subwoofer

1 Press SPK-LEVEL to show the target speaker indication on the display window.

Each time you press the button, the indication of the speakers changes as follows:

FRONTL → FRONTR → CENTER →
 SURR(surround) L → SURR(surround) R →
 SUBWFR → (back to the beginning)

2 Press LEVEL +/- to adjust the output level from -6 to 6.

NOTE

- You can also make adjustments by using the setup menu shown on the TV screen. (See page 32.)
- The adjustments take effect for all sources.

Adjusting the sound

1 Press BASS/TREBLE to show "BASS" or "TREBLE" on the display window.

Each time you press the button, the indication alternates between "BASS" and "TREBLE".

2 Press LEVEL +/- to adjust the level from -8 to 8.

NOTE

- The adjustments take effect for all sources.

Changing the video signal

The system can be accommodated to your TV's video signal.

- While DVD is selected as the source and before playback

1 Press and hold SCAN MODE for 2 seconds.

The current setting appears on the display window.

2 Press Cursor ▶/◀ to select the desired mode.

- RGB: Select when your TV accommodates the interlaced RGB/composite video signal.
- Y/C: Select when your TV accommodates the interlaced S-video signal.

You can get better picture quality in the order — "RGB" > "Y/C".

3 Press ENTER while the selected mode is shown on the display window.

NOTE

- Although the picture may be distorted when you press ENTER, this is not a malfunction of the system.
- "RGB" is selected at your purchase.

Playback

- The mark  shows the types of discs the operation is available for.

The buttons described below are used on pages 16 to 19.

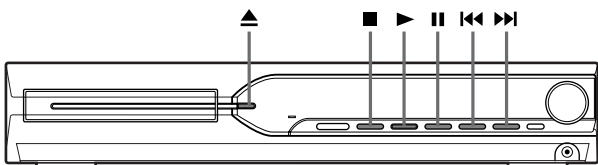
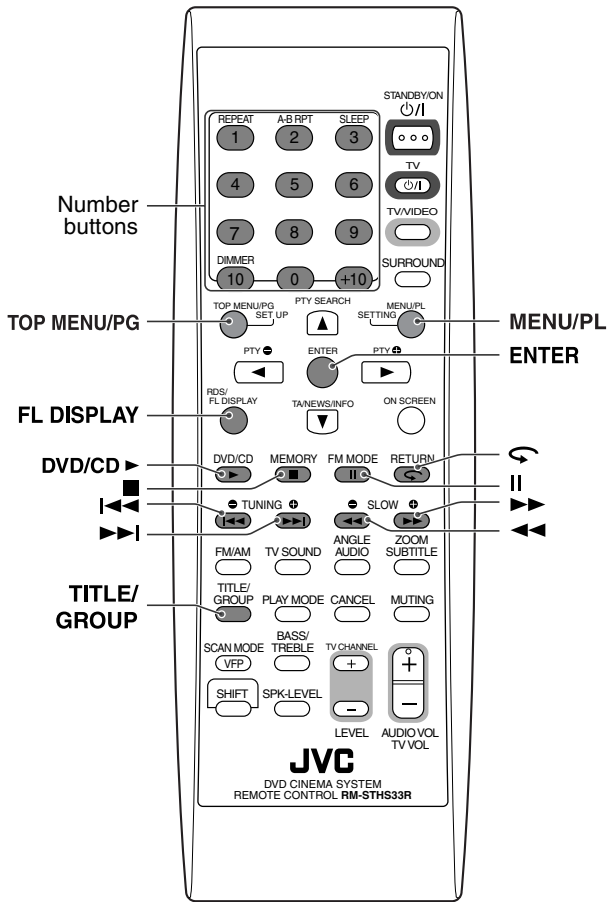

Basic Playback

1 Press on the center unit.

- The system turns on and the disc tray comes out.

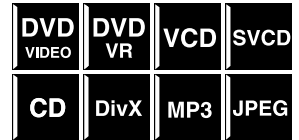

2 Place a disc.

Label side up

When placing an 8 cm (3 inches) disc

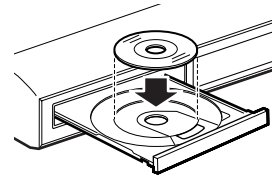
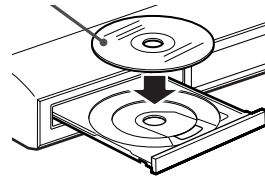

3 Press DVD/CD (play button).

For MP3

The file control display (see page 24) appears on the TV screen.

For JPEG

Each file (still pictures) is shown on the TV screen for about 3 seconds (slide-show). When stopping playback, the file control display (see page 24) appears on the TV screen.

For DivX files

During a readout time, "READING INDEX" may appear on the TV screen.

Pressing TOP MENU/PG or MENU/PL shows the file control display (see page 24) on the TV screen during playback.

For DVD VR disc

Pressing TOP MENU/PG or MENU/PL shows the control display on the TV screen (see page 19).

■ To pause

Press .











To return to playback, press  (play button).

■ To stop

Press .

■ On-screen guide icons

During DVD VIDEO playback, the following guide icons may appear for a while on the TV screen;

- : appears at the beginning of a scene containing multi-subtitle languages.
- : appears at the beginning of a scene containing multi-audio languages.
- : appears at the beginning of a scene containing multi-angle views.
-  (Play),  (Pause),  /  (Fast forward/fast-reverse),  /  (Slow-motion forward/reverse): appears when you perform each operation.
- : the disc cannot accept an operation you have tried to do.

NOTE

- (For JPEG) The system cannot accept operations even though you press any buttons before the entire picture appears on the TV screen.
- If you do not want the on-screen guide icons to appear, see page 33.

■ Playback information on the display window

DVD VIDEO

Example:

When a DVD VIDEO encoded with Dolby Digital 5.1ch is played

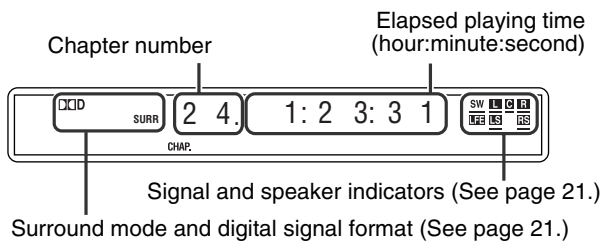

Pressing FL DISPLAY

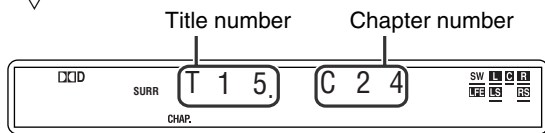

DVD VR disc

Example:

During playback on the Original program*

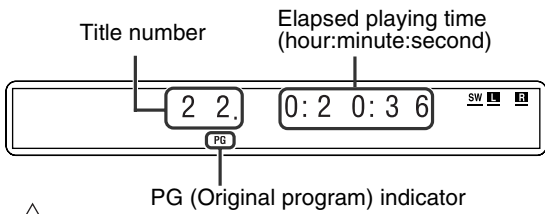

Pressing FL DISPLAY

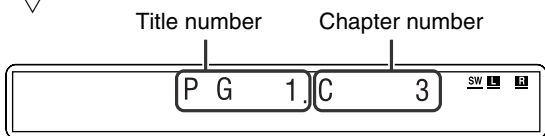

Example:

During playback on the Playlist*

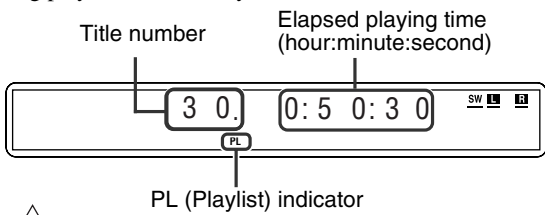

Pressing FL DISPLAY

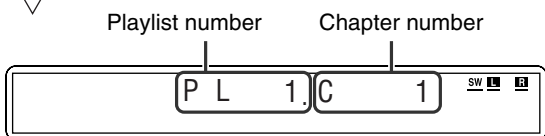

* Pressing TOP MENU/PG or MENU/PL, you can change the play mode. (See page 19.)

VCD/SVCD/CD

Example:

When a CD is played back

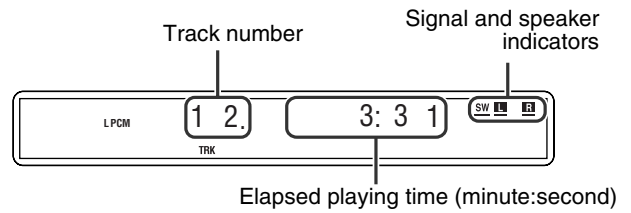

NOTE

- When a VCD or SVCD with PBC function is played, the elapsed playing time does not appear, but "PBC" appears.

MP3 file

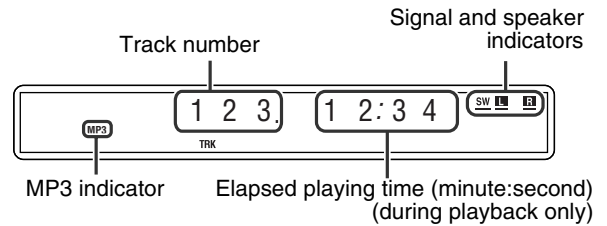

Pressing FL DISPLAY

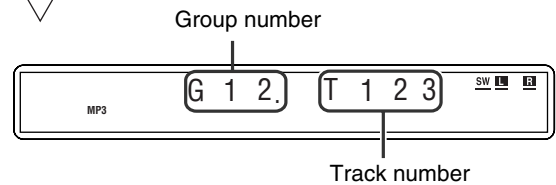

JPEG file

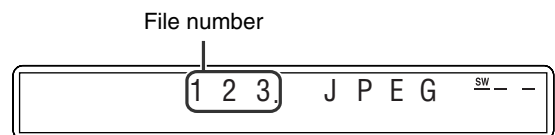

Pressing FL DISPLAY

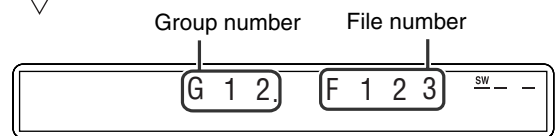

DivX file

Example:

When a DivX file is played.

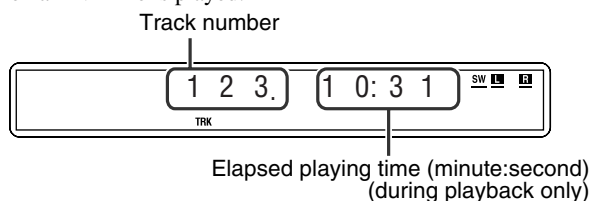

Pressing FL DISPLAY

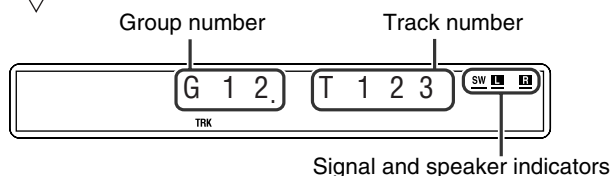

NOTE

- You can change the time information mode (except for MP3/JPEG/DivX). (See page 22.)
- You can also check the playback information on the TV screen. (See page 21.)

■ Screen saver

A TV screen may burn out if a static picture is displayed for a long time. To prevent this, the system automatically dims the screen if a static picture is displayed for over 5 minutes (the screen saver function).

- Pressing any button will cancel the screen saver function.
- If you do not want to use the screen saver function, see page 32.

One Touch Replay

You can move back the playback position by 10 seconds from the current position.



- During playback

On the remote control:

Press .

NOTE

- This function works in the same title.
- This feature may not work for some discs.

Fast-forward/fast-reverse search

- During playback

On the remote control:

Press or .

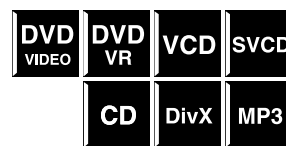

Each time you press the button, the search speed changes (x2, x5, x10, x20, x60).

To return to normal speed playback

Press DVD/CD (play button).

On the center unit:

Press and hold or .

Continuously pressing or increases the fast-forward/reverse search speed (x5 → x20).

NOTE

- When a DVD VIDEO, DVD VR, VCD, SVCD or DivX is played back, no sound comes out during fast-forward/reverse search.
- When a CD is played back, sound is intermittent and low during fast-forward/reverse search.
- This feature may not work for some discs.
- For MP3, the search speed is not shown.
- The search speed for DivX is 1, 2, 3 for forward search, and 1, 2 and 3 for reverse search.

Skip to the beginning of a desired selection

- Using / buttons

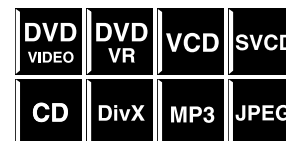

- For DVD VIDEO/DVD VR (chapter): During playback
- For VCD/SVCD (track):

During playback without PBC function

For CD/MP3/JPEG/DivX (track/file): During playback or while stopped

Press or repeatedly.

NOTE

- When playing back an MP3/JPEG, you can make operations using the file control display. (See page 24.)
- When playing back a DivX file, pressing Cursor / may skip the scene a few minutes forward/backward.
- This feature may not work for some discs.

- Using number buttons on the remote control

- For DVD VIDEO/DVD VR (title, chapter): While stopped, the title number is selected. During playback, the chapter number is selected.
- For VCD/SVCD (track): During playback without PBC function
- For CD/MP3/JPEG/DivX (track/file): During playback or while stopped

Press number buttons (0-10, +10) to select the desired number.

- For details on using the number buttons, see “How to use the number buttons” below.

How to use the number buttons

- To select 3: Press 3.
- To select 14: Press +10, then 4.
- To select 24: Press +10 twice, then 4.
- To select 40: Press +10 three times, then 10. Or press +10 four times, then 0.

Locating a desired title/group using number buttons

■ During playback or while stopped.

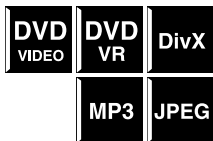

1 Press TITLE/GROUP.

“_ _” or “_” is shown in the title/group display area in the display window.

Example:

During DVD VIDEO playback

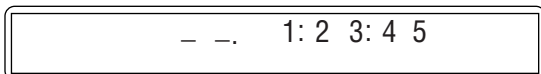

2 While the display window shows “_ _” or “_”, use number buttons (0-10, +10) to enter the desired title or group number.

The system starts playback from the first chapter/track/file of the selected title/group.

- For details on using the number buttons, see “How to use the number buttons”. (See page 18.)

NOTE

- This feature may not work for some discs.

Selecting the desired title/playlist from the control display

■ During playback or while stopped.



1 Press TOP MENU/PG or MENU/PL.

The control display is shown on the TV screen, and the system starts playback of the first title/playlist.

- The PLAY LIST is shown only when the playlist is on the DVD VR disc.

TOP MENU/PG: shows the ORIGINAL PROGRAM.

Example:

ORIGINAL PROGRAM					
No	Date	Ch	Time	Title	
1	25/04/04	4ch	19:00	JVC DVD World 2004	
2	17/05/04	8ch	10:30		
3	22/05/04	8ch	17:00	Music Festival	
4	26/05/04	L-1	13:19	children 001	
5	20/06/04	4ch	22:00		
6	25/06/04	L-1	8:23	children 002	

- *1: Title number
- *2: Recording date
- *3: Recording source (TV station, the input terminal of the recording equipment etc.)
- *4: Start time of recording
- *5: Title of the original program/playlist (The title may not be displayed depending on the recording equipment.)
- *6: Current title

MENU/PL: shows the PLAY LIST.

Example:

PLAY LIST				
No	Date	Chap	Length	Title
1	25/05/04	001	1:03:16	My JVC World
2	17/06/04	005	1:35:25	
3	20/06/04	003	0:10:23	Favorite music
4	25/06/04	001	0:07:19	children001-002

- *7: Playlist number
- *8: Creating date of playlists
- *9: Number of chapters
- *10: Total playing time
- *11: Current playlist

2 Press ▼/▲ to select the desired title/playlist.

The system starts playback of the selected title/playlist.

To clear the control display

- Press ENTER.

About the play mode on a DVD VR disc

- Original program (ORIGINAL PROGRAM):
The system can play back the original picture in the recorded order.
- Playlist (PLAY LIST):
The system can play back the playlist edited by the recording equipment.

Advanced operations

- The mark  shows the types of discs the operation is available for.

The buttons described below are used on pages 20 to 30.

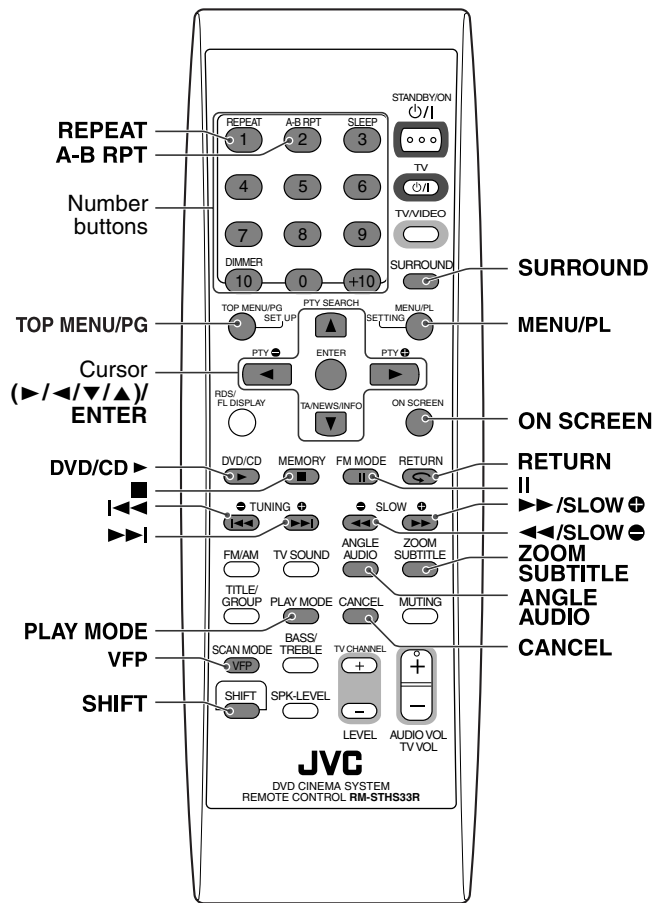

Using the surround mode

■ Auto Surround (AUTO SURR)

This function automatically selects the appropriate surround mode according to the input signals. For example, a multichannel source is automatically reproduced in multichannel audio.

■ Dolby Surround

Dolby Pro Logic II*¹

Dolby Pro Logic II has a developed multichannel playback format to decode all 2 channel sources — stereo source and Dolby Surround encoded source — into a 5.1 channel.

Dolby Pro Logic II has two modes — Movie mode and Music mode:

• Pro Logic II Movie (MOVIE)

Suitable for reproduction of Dolby Surround encoded sources bearing the mark .

• Pro Logic II Music (MUSIC)

Suitable for reproduction of any 2 channel stereo music sources.

Dolby Digital*¹

Used to reproduce multichannel soundtracks of the software encoded with Dolby Digital (.

■ DTS Digital Surround*²

Used to reproduce multichannel soundtracks of the software encoded with DTS Digital Surround (.

DTS Digital Surround (DTS) is another discrete multichannel digital audio format available on CD and DVD software.

Available Surround modes for each input signal

The √ marks show available surround modes.

Signal	Mode	Surround off	Auto Surround	Dolby Surround			DTS Digital Surround	DSP
		SURR OFF	AUTO SURR	MOVIE* ³	MUSIC* ³	Dolby Digital	DTS	ALL ST* ³
Dolby Digital (Multichannel)		√	√	—	—	√	—	—
Dolby Digital (2 channel)		√	√	√	√	—	—	√
DTS Digital Surround (Multichannel)		√	√	—	—	—	√	—
DTS Digital Surround (2 channel)		√	√	√	√	—	—	√
Analog or Linear PCM		√	√	√	√	—	—	√

*¹ Manufactured under license from Dolby Laboratories. “Dolby”, “Pro Logic”, and the double-D symbol are trademarks of Dolby Laboratories.

*² “DTS” and “DTS Digital Surround” are registered trademarks of Digital Theater Systems, Inc.

*³ You can select these modes by pressing SURROUND. (See page 21.)

Continued on next page

■ All Channel Stereo

All Channel Stereo (ALL ST) mode can reproduce a larger stereo sound field using all the connected (and activated) speakers. All Channel Stereo can be used while reproducing 2 channel stereo source.

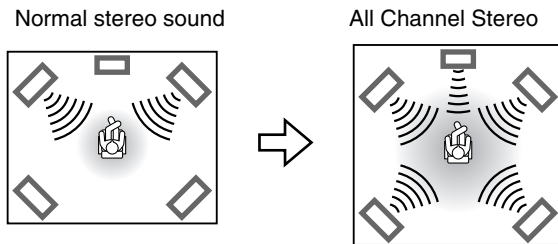

■ Indicators on the display window

Digital signal format indicators

- LPCM, SURR: Lights when Linear PCM signal comes in.
- DD, SURR: Lights when Dolby Digital signals come in.
- DTS, SURR: Lights when DTS Digital (Surround) signals come in.
- No indication: No digital signal indicator lights when analog signals come in.

Dolby Surround mode indicators

- PLII: Lights when Dolby Pro Logic II mode is activated.

Source signal indicators, etc.

Light to indicate the incoming signals.



- L**: Lights when the front left channel signal comes in.
- C**: Lights when the center channel signal comes in.
- R**: Lights when the front right channel signal comes in.
- LFE**: Lights when the LFE channel signal comes in.
- LS**: Lights when the surround left channel signal comes in.
- RS**: Lights when the surround right channel signal comes in.
- S**: Lights when the monaural surround channel signal or 2 channel Dolby Surround signal comes in.
- SW**: Always lights.

The channel with “—” shows that the corresponding speakers are reproducing the channels’ sound. If the channels’ sound decoded into 5.1 channel is reproduced, only “—” lights.

Selecting the surround mode

The system is set up to automatically select the optimal surround mode for input signal from digital multichannel software. When playing back 2 channel source, you can select the desired surround mode manually.

NOTE

- This function also takes effect for the sources other than DVD.
- For FM/AM and TV SOUND, you can select All Channel Stereo (ALL ST) or SURR OFF.
- For DivX, the surround mode takes no effects.

■ When playing back digital multichannel software (except during SURR OFF mode)

The appropriate multichannel surround mode (Dolby Digital, DTS Digital Surround or Linear PCM) is automatically selected.

■ When playing back 2 channel source

You can select either mode of Dolby Pro Logic II (MOVIE/MUSIC) or the DSP (ALL ST) mode.

Press SURROUND repeatedly to select the desired mode.

The surround mode is turned on and the current surround mode appears on the display window. Each time you press the button, the surround mode changes. For details on each mode, see page 20.

To turn off the surround mode

Press SURROUND repeatedly until “SURR OFF” appears on the display window.

Storing adjustments — auto memory

When you turn the power off, the system memorizes the current surround mode. The memorized mode is automatically recalled when you turn the power on.

Using the on-screen bar

You can check disc information and you can use some functions using the on-screen bar.

Showing the on-screen bar

- Whenever a disc is loaded

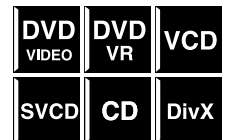

Press ON SCREEN.

Each time you press the button, the on-screen bar changes as follows on the TV screen.

Example:

During DVD VIDEO playback

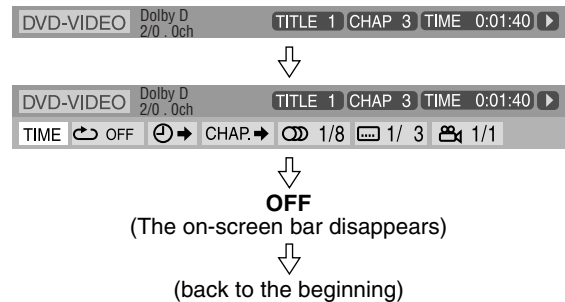

- The currently selected item shows green.

■ Contents of the on-screen bar during playback

DVD VIDEO

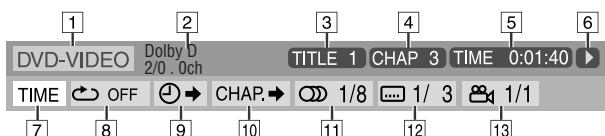

DVD VR disc

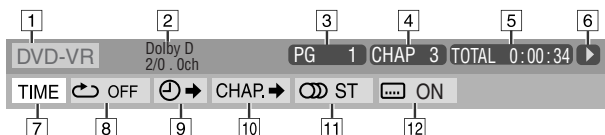

VCD

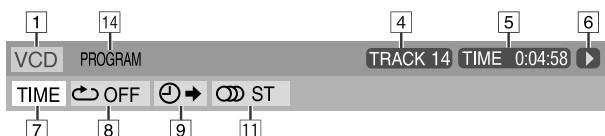

SVCD

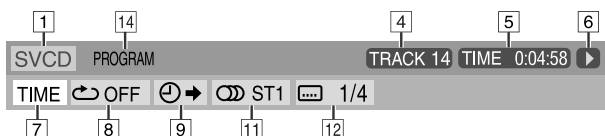

CD



DivX



- 1 Shows disc type.
- 2 Shows audio information.
- 3 Shows current title number.
- 4 Shows current chapter number (for DVD VIDEO and DVD VR) or track number (for other type of discs).
- 5 Shows time information. See “Changing the time information”.

- 6 Shows playback status.
 - ▶: appears during playback.
 - ▶▶ / ◀◀: appears during fast forward/reverse.
 - ▶◀ / ◀▶: appears during playback in forward slow-motion/reverse slow-motion.
 - ⏸: appears when paused.
 - ⏹: appears when stopped.
- 7 Select this to change time information (5). See “Changing the time information”.
- 8 Select this for Repeat Playback. (See page 29.)
- 9 Select this for time search function. (See page 24.)
- 10 Select this for chapter search function. (See page 23.)
- 11 Select this to change audio language, channel, or stream. (See page 26.)
- 12 Select this to change subtitle language. (See page 26.)
- 13 Select this to change view angle. (See page 25.)
- 14 Shows Playback Mode status.
 - PROGRAM: appears during Program Playback. (See page 28.)
 - RANDOM: appears during Random Playback. (See page 28.)
- 15 Shows Repeat Mode status. (See page 29.)

Changing the time information

You can change the time information in the on-screen bar on the TV screen and the display window of the center unit.



- During playback
- 1 Press ON SCREEN twice. The on-screen bar appears on the TV screen.
- 2 Press Cursor ▶ / ◀ to highlight TIME .
- 3 Press ENTER repeatedly to select the desired information.

Example:

When elapsed playing time of disc is selected.

TOTAL 1:25:58

- VCD/SVCD/CD
 - TIME: Elapsed playing time of current track
 - REM: Remaining time of current track
 - TOTAL: Elapsed time of disc
 - T. REM: Remaining time of disc
- DVD VIDEO/DVD VR
 - TIME: Elapsed playing time of current chapter
 - REM: Remaining time of current chapter
 - TOTAL: Elapsed time of Title/Program
 - T. REM: Remaining time of Title/Program

4 Press ON SCREEN.

The on-screen bar disappears.

NOTE

- When playing back DVD VR, “TIME” and “REM” cannot be shown.

Playing from a specified position on a disc

You can start playing a title, chapter or track you specify. You can also play a disc from specified time.

Locating a desired scene from the DVD menu

DVD VIDEOS generally have their own menus which show disc contents and you can display them on the TV screen. You can locate a desired scene by using these menus.



- Whenever a DVD VIDEO is loaded

1 Press TOP MENU/PG or MENU/PL.

The menu appears on the TV screen.

Example:

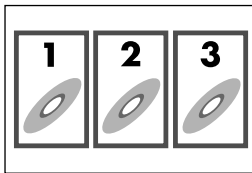

Normally, a DVD VIDEO which contains more than one title will have a "top" menu which lists the titles. Press TOP MENU/PG to show the title menu.

Some DVD VIDEO may also have a different menu which is shown by pressing MENU/PL.

See the instructions for each DVD VIDEO regarding its particular menu.

2 Use Cursor ▶/◀/▼/▲ to select a desired item.

3 Press ENTER.

- With some discs, you can also select items by entering the corresponding number using number buttons.

Locating a desired scene using a VCD/SVCD menu with PBC

A VCD or SVCD recorded with PBC has its own menus such as a list of contained songs. You can locate a specific scene by using these menus.



- During playback with PBC function

1 Press RETURN repeatedly, with SHIFT pressed until the menu appears on the TV screen.

Example:

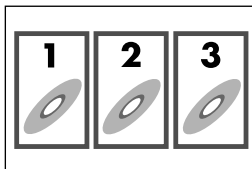

2 Press number buttons (1-10, +10) to select the number of the desired item.

- For details on using the number buttons, see "How to use the number buttons". (See page 18.)

To return to the menu

Press RETURN repeatedly until the menu screen appears.

When "NEXT" or "PREVIOUS" is shown on the TV screen:

- To go to the next page, press ▶▶.
- To return to the previous page, press ◀◀.

NOTE

- If you want to play a PBC-compatible VCD/SVCD without using the PBC function, perform any of the following:
 - Start playback by pressing number buttons while stopped.
 - Press ▶▶ repeatedly until the desired track number is displayed, then start playback by pressing ▶ (play button). The track number appears on the display window instead of "PBC".
- To activate the PBC function when playing a PBC-compatible VCD/SVCD without using the PBC function, perform any of the following:
 - Press TOP MENU/PG or MENU/PL.
 - Press ■ twice to stop playback, then press ▶ (play button).

Locating a desired chapter using the on-screen bar

- During playback



1 Press ON SCREEN twice.

The on-screen bar appears on the TV screen.

2 Press Cursor ▶/◀ to highlight CHAP.→.

3 Press ENTER.

Example:

During DVD VIDEO playback

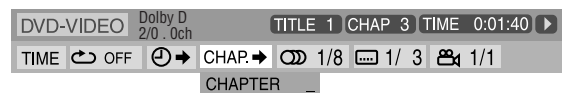

4 Press number buttons (0-9) to enter the desired chapter number.

Example:

- To select 8: Press 8.
- To select 10: Press 1, then 0.
- To select 20: Press 2, then 0.
- To select 37: Press 3, then 7.

To correct a misentry

Repeat step 4.

5 Press ENTER.

6 Press ON SCREEN.

The on-screen bar disappears.

NOTE

- You can select up to the 99th chapter.

Locating a desired position by specifying the time

You can locate a desired position by specifying the time from the beginning of the disc (while stopped) or the current title/track (during playback).

- For DVD VIDEO/DVD VR:
 - During playback
- For VCD/SVCD:
 - While stopped or during playback without PBC function
- For CD:
 - During playback or while stopped

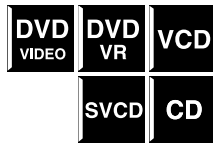

■ When specifying the elapsed playing time from the beginning of the disc

Perform the following procedure while stopped.

■ When specifying the elapsed playing time from the beginning of current title/track

Perform the following procedure during playback.

1 Press ON SCREEN twice.

The on-screen bar appears on the TV screen.

2 Press Cursor ▶/◀ to highlight ⌚.

3 Press ENTER.



4 Use number buttons (0-9) to enter the time.

You can specify the elapsed playing time from the beginning of the disc (while stopped) or from the beginning of the current title/track (during playback).

Example:

To play back from a point 2 (hours): 34 (minutes): 08 (seconds) elapsed

TIME _:__:__ ⇒ TIME 2:__:__ ⇒
Press 2 Press 3

TIME 2:3_:__ ⇒ TIME 2:34:__: ⇒
Press 4 Press 0

TIME 2:34:0_ ⇒ TIME 2:34:08
Press 8

To cancel a misentry
Press Cursor ◀ repeatedly.

5 Press ENTER.

6 Press ON SCREEN.

The on-screen bar disappears.

NOTE

- You can specify time in hours/minutes/seconds for DVD VIDEO/DVD VR and in minutes/seconds for VCD/SVCD/CD.

Using the file control display

You can search and play desired groups and tracks/files using the file control display on the TV screen.



Current group / total group number Playback mode (PROGRAM, RANDOM, REPEAT)

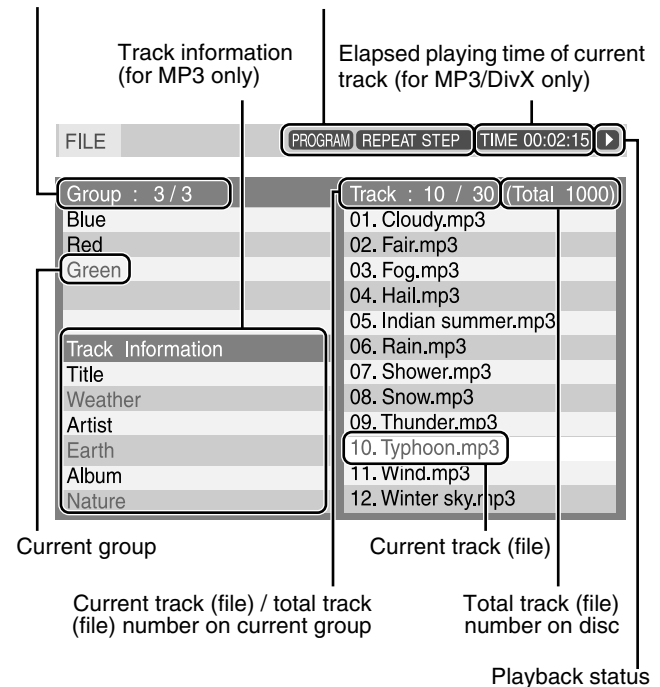

The file control display appears automatically during playback (for MP3) or while stopped.

- For MP3:
During playback or while stopped
- For JPEG/DivX:
While stopped

1 Press Cursor **▶/◀/▼/▲** to select the desired group/track/file.

- For MP3, playback starts from the selected track.
- For JPEG, proceed to perform the following operation.

2 Press **DVD/CD▶** or **ENTER**.

- Track playback/slide-show starts from the selected track/file.
- When you press **ENTER** for JPEG, only the selected file is played back.

To skip the file during playback

Press **▶▶/◀◀** or Cursor **▲/▼**.

NOTE

- You can also check playback information on the display window. (See page 17.)
- Some group, track and file names may not be displayed correctly depending on recording conditions.
- The order of groups, tracks and files may be displayed differently from the order displayed on your personal computer.

Resume Playback

When Resume Playback is set to “ON” (see page 33) and you stop playback by the following operations, the position where playback has been stopped is stored. (“RESUME” appears on the display window.)

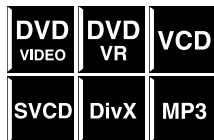

- Turning off the power (see page 13)
- Pressing **■** once
- Changing the source (see page 14)

To start playback from the stored position

(“RESUME” disappears.)

- Press **▶** (play button) on the remote control or the center unit.
- Select DVD as the source again if you changed the source.

To clear the stored position

Press **■** again or open the disc tray.

NOTE

- (For DivX) The beginning of a scene where playback has been stopped may be stored.

Selecting a view angle

- During playback of a disc containing multi-view angles



When using the **ANGLE** button:

1 Press **ANGLE**, with **SHIFT** pressed.

Example:

The first view angle is selected out of 3 view angles recorded.

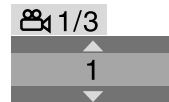

2 Press **ANGLE** repeatedly, with **SHIFT** pressed or Cursor **▼/▲** to select the desired view angle.

When using the on-screen bar:

1 Press **ON SCREEN** twice.

The on-screen bar appears on the TV screen.

2 Press Cursor **▶/◀** to highlight **1/3**.

3 Press **ENTER**.

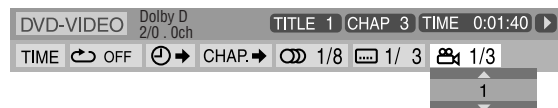

4 Press Cursor **▼/▲** to select the desired view angle.

5 Press **ENTER**.

6 Press **ON SCREEN**.

The on-screen bar disappears.

Selecting the subtitle

- During playback of a disc containing subtitles in several languages



When using the **SUBTITLE** button:

1 Press SUBTITLE.

Example (DVD VIDEO):

“ENGLISH” is selected out of 3 subtitle languages recorded.

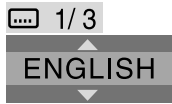

2 Press Cursor ▼/▲ to select the desired subtitle.

For DVD VR

- Pressing SUBTITLE activates the subtitles (subpictures) regardless of whether the subtitles are recorded or not. (Subpictures will not change if no subpicture is recorded.)

For SVCD

- An SVCD can contain up to four subtitles. Pressing SUBTITLE changes the subtitles regardless of whether the subtitles are recorded or not. (Subtitles will not change if no subtitle is recorded.)

NOTE

- Each time you press SUBTITLE, the subtitle appears and disappears alternately.

When using the on-screen bar:

1 Press ON SCREEN twice.

The on-screen bar appears on the TV screen.

2 Press Cursor ►/◀ to highlight 1/3 .

3 Press ENTER.

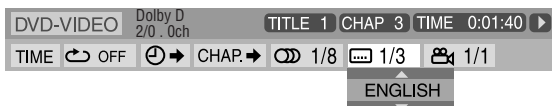

4 Press Cursor ▼/▲ repeatedly to select the desired subtitle.

5 Press ENTER.

6 Press ON SCREEN.

The on-screen bar disappears.

NOTE

- Some subtitle or audio languages are abbreviated in the pop-up window. See “The language codes list”. (See page 31.)
- Each time you press SUBTITLE, the subtitle appears and disappears alternately.
- For DivX, you cannot operate this procedure using the on-screen bar.

Selecting the audio

- During playback of a disc containing audio in several languages



When using the **AUDIO** button:

1 Press AUDIO.

Example (DVD VIDEO):

“ENGLISH” is selected out of 3 audio languages recorded.

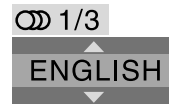

2 Press AUDIO repeatedly or Cursor ▼/▲ to select the desired audio.

When using the on-screen bar:

1 Press ON SCREEN twice.

The on-screen bar appears on the TV screen.

2 Press Cursor ►/◀ to highlight 1/3 .

3 Press ENTER.

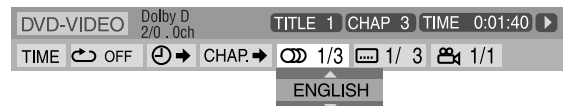

4 Press Cursor ▼/▲ to select the desired audio.

5 Press ENTER.

6 Press ON SCREEN.

The on-screen bar disappears.

NOTE

- Some subtitle or audio languages are abbreviated in the pop-up window. See “The language codes list”. (See page 31.)
- “ST”, “L” and “R” is displayed when playing a DVD VR, VCD or SVCD respectively representing “stereo”, “left sound” and “right sound”.
- For DivX, you cannot operate this procedure using the on-screen bar.

Special picture playback

Frame-by-frame playback

- During playback

Press **II** repeatedly.

Each time you press the button, the still picture advances by one frame.

To return to normal playback

Press DVD/CD ►.

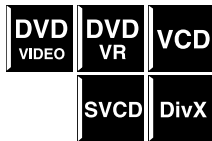

Playing back in slow-motion

- During playback

1 Press **II** at the point where you want to start playback in slow-motion from.

The system pauses playback.

2 Press **SLOW** ⊕.

- Playback in forward slow-motion starts.

For DVD VIDEO only:

- To play back in reverse slow-motion, press SLOW ⊖.

Each time you press the button, the playback speed become faster.

To return to normal playback

Press DVD/CD ►.

NOTE

- Sound cannot be heard during slow-motion playback.

Zooming in

- During playback or while paused

1 Press **ZOOM**, with **SHIFT** pressed.

Each time you repeat the procedure, the scene magnification changes.

2 While zoomed in, press **Cursor** ►/◄/▼/▲ to move zoom-in area.

To return to normal playback

Press ZOOM repeatedly, with SHIFT pressed to select OFF.

NOTE

- The number of the magnification steps varies depending on the disc type.
- During slide-show playback of JPEG, zooming in is not available. In such a case, press **II** to pause slide-show playback, then zoom in.
- During playback of JPEG/DivX, there may be a case where **Cursor** (►/◄/▼/▲) does not work in step 2.

Changing the VFP setting

The VFP (Video Fine Processor) function enables you to adjust the picture character according to the type of programming, picture tone or personal preference.

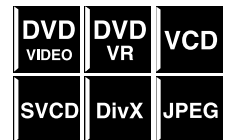

- During playback

1 Press **VFP**.

The current VFP settings appear on the TV screen.

Example:

NORMAL	
GAMMA	0
BRIGHTNESS	0
CONTRAST	0
SATURATION	0
TINT	0
SHARPNESS	0

2 Press **Cursor** ►/◄ repeatedly to select the VFP mode.

- NORMAL: Normally select this.
- CINEMA: Suitable for movies.

When you select "NORMAL" or "CINEMA", press VFP to complete the setting.

- USER 1 and USER 2:

You can adjust parameters that affect picture appearance.

Only when selecting "USER 1" or "USER 2" in step 2, proceed to perform the following operation;

3 Press **Cursor** ▼/▲ repeatedly to select a parameter you want to adjust.

Adjust gradually and confirm picture appearance results are as preferred.

- GAMMA: Controls brightness of neutral tints while maintaining brightness of dark and bright portions.
- BRIGHTNESS: Controls screen brightness.
- CONTRAST: Controls screen contrast.
- SATURATION: Controls screen color depth.
- TINT: Controls screen tint.
- SHARPNESS: Controls screen sharpness.

4 Press ENTER.

Example:



5 Press Cursor ▼/▲ to change the setting.

6 Press ENTER.

The current VFP settings appear again.

7 Repeat steps 3 to 6 to adjust other parameters.

8 Press VFP.

NOTE

- Although the setting display disappears in the middle of the procedure, the setting at that time will be stored.

Program Playback

- While stopped



1 Press PLAY MODE repeatedly until program window appears on the TV screen.

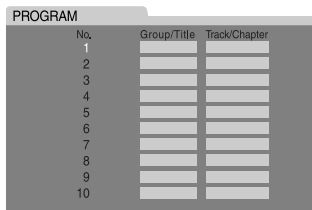

USE NUMERIC KEYS TO PROGRAM TRACKS.
USE CANCEL TO DELETE THE PROGRAM.

2 Follow the instructions that appear on the TV screen to program the desired chapters/tracks.

- For details on using the number buttons, see "How to use the number buttons". (See page 18.)
- The content's numbers that you have to specify for programming varies depending on the disc type:
 - DVD VIDEO: Titles and chapters
 - VCD, SVCD, CD: Tracks
 - MP3: Groups and tracks
- You can specify the chapters/tracks whose number is up to 99.
- (For CD, SVCD or VCD) When the total playback time exceeds 99 minutes 59 seconds, ":-:" will appear on the display window. But, it is possible to continue programming.

To clear the programs one by one from the last entered number

Press CANCEL repeatedly.

To clear all programs

Press ■.

You can also clear the program by turning off the system.

3 Press DVD/CD▶ to start Program Playback.

If all of the programmed tracks/files have been played back, playback stops and the program window appears again. Note that program setting remains.

To check the program contents

During playback, press ■. Playback stops and the program window appears.

To quit the Program mode

While stopped, press PLAY MODE repeatedly until both program window and "RANDOM" disappears from the TV screen.

NOTE

- The Resume function cannot be used with Program Playback.
- Program Playback may not work for some discs.

Random Playback

You can play titles or tracks on a disc in random order.



- While stopped

1 Press PLAY MODE repeatedly until "RANDOM" appears on the TV screen.

2 Press ▶ (play button).

After playing all titles/tracks on the disc, the system stops playback and quits the Random mode.

To quit the Random mode

While stopped, press PLAY MODE repeatedly until both program window and "RANDOM" disappear from the TV screen.

You can also clear the Random mode by turning off the system.

NOTE

- The same title/track will not be played back more than once during Random Playback.

Repeat Playback

Repeating the current selection

- For DVD VIDEO/DVD VR:
During playback
- For VCD/SVCD:
During playback without PBC
function or stopped
- For CD/MP3/JPEG/DivX:
During playback or stopped

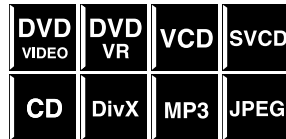

When using the REPEAT button:
Press REPEAT, with SHIFT pressed.

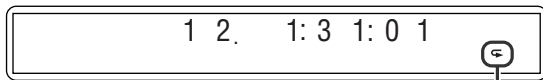

Repeat mode indicator

Each time you press REPEAT, the Repeat mode changes.

Display window	TV screen	Meanings
↻	↻GROUP	Repeats the current group for MP3/JPEG/DivX.
	REPEAT GROUP	
	↻TITLE	Repeats the current title for DVD VIDEO.
	↻PG	Repeats the current title for Original program for DVD VR.
	↻PL	Repeats the current playlist for Playlist for DVD VR.
↻ ALL	↻ALL	Repeats all title/tracks/files for DVD VR/VCD/SVCD/CD/MP3/JPEG/DivX.
	REPEAT ALL	
↻ 1	↻TRACK, ↻STEP	Repeats the current track for VCD/SVCD/CD/MP3/DivX.
	REPEAT TRACK, REPEAT STEP	
	↻CHAP, ↻STEP	Repeats the current chapter for DVD VIDEO/DVD VR.
	REPEAT STEP	
No indication	↻OFF	Repeat mode is off. The system plays back the disc normally.

NOTE

- For DVD VIDEO, REPEAT ALL may not be available depending on the disc.

When using the on-screen bar (except for MP3/JPEG/DivX):

- 1 Press ON SCREEN twice.
The on-screen bar appears on the TV screen.
- 2 Press Cursor ▶/◀ to highlight OFF.
- 3 Press ENTER.



- 4 Press Cursor ▼/▲ repeatedly to select the Repeat mode.
- 5 Press ENTER.
- 6 Press ON SCREEN.

The on-screen bar disappears.

To cancel Repeat Playback

Select "OFF" in step 4.

Repeating a desired part [A-B Repeat]

You can repeat playback of a desired part by specifying the beginning (point A) and ending (point B).



- During playback

When using the A-B RPT button:

- 1 Press A-B RPT, with SHIFT pressed at the beginning of the part you want to repeat (point A).
The repeat mode indicator "↻ A -" appears on the display window.
- 2 Press A-B RPT again, with SHIFT pressed at the end of the part you want to repeat (point B).
The repeat mode indicator on the display window changes to "↻ A - B" and A-B Repeat Playback starts. The selected part of the disc (between point A and B) is played repeatedly.



To cancel

Press A-B RPT, with SHIFT pressed during A-B Repeat Playback.

When using the on-screen bar:

1 Press ON SCREEN twice.

The on-screen bar appears on the TV screen.

2 Press Cursor ►/◄ to highlight  **OFF.**

3 Press ENTER.

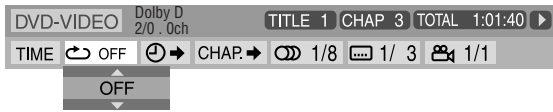

4 Press Cursor ▼/▲ repeatedly to select “A-B”.

5 Press ENTER at the beginning of the part you want to repeat (point A).



6 Press ENTER at the end of the part you want to repeat (point B).

A-B Repeat Playback starts.

7 Press ON SCREEN.

The on-screen bar disappears.

To cancel

Select “OFF” in step 4, then press ENTER.

NOTE

- When playing back a DVD VIDEO, A-B Repeat Playback is possible only within the same title.
- “A-B” cannot be selected during Program and Random Playback.
- “A-B” cannot be selected during playback with PBC function.

Tray lock

You can lock the tray and prohibit the unwanted disc ejection.

On the center unit ONLY:

While the system is on standby mode, press ▲, with ■ pressed and held.

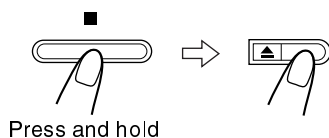

Press and hold

- The system turns on and “LOCKED” appears on the display window.
- If you try to eject the disc, “LOCKED” appears to indicate that the tray is locked.

To cancel

Carry out the same operation again.

- The system turns on and “UNLOCKED” appears on the display window.

Balance Setting

You can adjust the balance between the front left and front right speakers.

NOTE

- This function also takes effect for the sources other than DVD.
- Before you start operation; There is a time limit when doing the following steps. If the setting is cancelled before you finish, start from step 1 again.

1 Press SETTING, with SHIFT pressed.

Example:



2 Press Cursor ►/◄ to make an adjustment or selection.

Example:



The adjustment display automatically disappears a few seconds later with the current setting.

Setting DVD preferences

Using the setup menus

- You can change the language used in the setup menus. See “Menu description”.

Basic operation on the setup menus

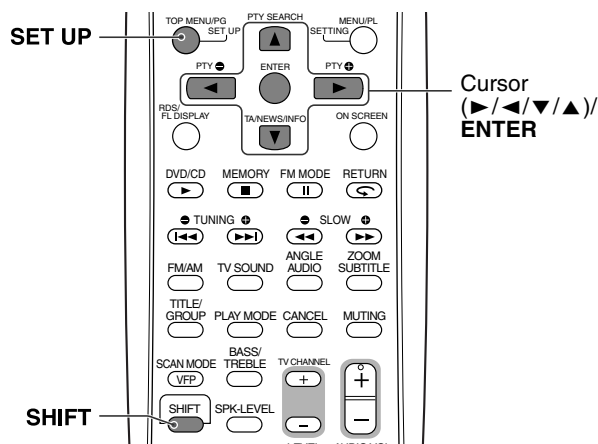

- While stopped

1 Press **SET UP**, with **SHIFT** pressed.

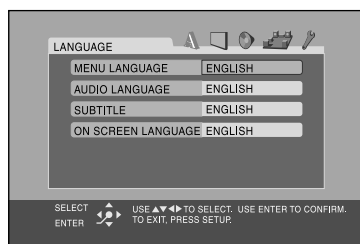

2 Follow the instructions that appear on the TV screen.

Menu description

A: Language menu (LANGUAGE)

■ MENU LANGUAGE

Some DVDs have their own menus in multiple languages.

- Select the initial menu language*.

■ AUDIO LANGUAGE

Some DVDs have multiple audio languages.

- Select the initial audio language*.

■ SUBTITLE

Some DVDs have multiple subtitle languages.

- Select the initial subtitle language*.

■ ON SCREEN LANGUAGE

- Select the language shown on the TV screen when operating this system.

* When the language you have selected is not recorded to a disc, the original language is automatically used as the initial language.

NOTE

- See the following “The language codes list” for the code of each language, such as “AA”, etc.

The language codes list

AA	Afar	IK	Inupiak	RN	Kirundi
AB	Abkhazian	IN	Indonesian	RO	Rumanian
AF	Afrikaans	IS	Icelandic	RU	Russian
AM	Ameharic	IW	Hebrew	RW	Kinyarwanda
AR	Arabic	JI	Yiddish	SA	Sanskrit
AS	Assamese	JW	Javanese	SD	Sindhi
AY	Aymara	KA	Georgian	SG	Sangho
AZ	Azerbaijani	KK	Kazakh	SH	Serbo-Croatian
BA	Bashkir	KL	Greenlandic	SI	Singhalese
BE	Byelorussian	KM	Cambodian	SK	Slovak
BG	Bulgarian	KN	Kannada	SL	Slovenian
BH	Bihari	KO	Korean (KOR)	SM	Samoan
BI	Bislama	KS	Kashmiri	SN	Shona
BN	Bengali, Bangla	KU	Kurdish	SO	Somali
BO	Tibetan	KY	Kirghiz	SQ	Albanian
BR	Breton	LA	Latin	SR	Serbian
CA	Catalan	LN	Lingala	SS	Siswati
CO	Corsican	LO	Laothian	ST	Sesotho
CS	Czech	LT	Lithuanian	SU	Sundanese
CY	Welsh	LV	Latvian, Lettish	SV	Swedish
DA	Danish	MG	Malagasy	SW	Swahili
DZ	Bhutani	MI	Maori	TA	Tamil
EL	Greek	MK	Macedonian	TE	Telugu
EO	Esperanto	ML	Malayalam	TG	Tajik
ET	Estonian	MN	Mongolian	TH	Thai
EU	Basque	MO	Moldavian	TI	Tigrinya
FA	Persian	MR	Marathi	TK	Turkmen
FI	Finnish	MS	Malay (MAY)	TL	Tagalog
FJ	Fiji	MT	Maltese	TN	Setswana
FO	Faroese	MY	Burmese	TO	Tonga
FY	Frisian	NA	Nauru	TR	Turkish
GA	Irish	NE	Nepali	TS	Tsonga
GD	Scots Gaelic	NL	Dutch	TT	Tatar
GL	Galician	NO	Norwegian	TW	Twi
GN	Guarani	OC	Occitan	UK	Ukrainian
GU	Gujarati	OM	(Afan) Oromo	UR	Urdu
HA	Hausa	OR	Oriya	UZ	Uzbek
HI	Hindi	PA	Panjabi	VI	Vietnamese
HR	Croatian	PL	Polish	VO	Volapuk
HU	Hungarian	PS	Pashto, Pushto	WO	Wolof
HY	Armenian	PT	Portuguese	XH	Xhosa
IA	Interlingua	QU	Quechua	YO	Yoruba
IE	Interlingue	RM	Rhaeto-Romance	ZU	Zulu

: Picture menu (PICTURE)

■ MONITOR TYPE

You can select the monitor type to match your TV when you play DVDs recorded in the picture's height/width ratio of 16:9.

- **16:9 (Wide television conversion)**
Select this when the aspect ratio of your TV is 16:9 (wide TV).
- **4:3 LB (Letter Box conversion)**
Select this when the aspect ratio of your TV is 4:3 (conventional TV). While viewing a wide screen picture, the black bars appear on the top and the bottom of the screen.
- **4:3 PS (Pan Scan conversion)**
Select this when the aspect ratio of your TV is 4:3 (conventional TV). While viewing a wide screen picture, the black bars do not appear, however, the left and right edges of the pictures will not be shown on the screen.

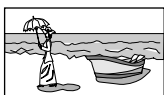

Ex.: 16:9



Ex.: 4:3 LB

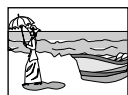

Ex.: 4:3 PS

NOTE

- Even if "4:3 PS" is selected, the screen size may become "4:3 LB" with some DVDs. This depends on how DVDs are recorded.

■ PICTURE SOURCE

You can obtain optimal picture quality by selecting whether the content on the disc is processed by field (video source) or by frame (film source).

Normally set to "AUTO".

- **AUTO**
Used to play a disc containing both video and film source materials.
This system recognizes the source type (video or film) of the current disc according to the disc information.
 - If the playback picture is unclear or noisy, or the oblique lines of the picture are rough, try to change to other modes.
- **FILM**
Suitable for playing back a film source disc.
- **VIDEO**
Suitable for playing back a video source disc.

■ SCREEN SAVER (See page 18.)

You can activate or deactivate Screen Saver function.

■ FILE TYPE

When several types of files are recorded on a disc, you can select which files to play.

- **AUDIO**
Select this to play MP3 files.
- **STILL PICTURE**
Select this to play JPEG files.
- **VIDEO**
Select this to play DivX files.

: Audio menu (AUDIO)

■ D. RANGE COMPRESSION

(Dynamic range compression)

You can enjoy low level recorded sound clearly at night even at a low volume when listening to the sound with Dolby Digital.

- **AUTO**
Select this when you want to enjoy surround sound with its full dynamic range (no effect applied).
- **ON**
Select this when you want to fully apply the compression effect (useful at midnight).

NOTE

- When you play a multichannel Dolby Digital source with the surround mode is off, the setting of D. RANGE COMPRESSION is set to ON automatically.

: Speaker setting menu (SPK. SETTING)

■ Level menu (LEVEL)

FRONT LEFT SPEAKER/FRONT RIGHT SPEAKER/ CENTER SPEAKER/SURROUND RIGHT SPEAKER/ SURROUND LEFT SPEAKER

While monitoring the test tone, adjust the output level of the speakers.

You can adjust the output level in the -6 dB to +6 dB range.

TEST TONE*

Outputs the test tone.

- * The test tone comes out of all of the activated speakers in the following sequence:

⇒ Front left speaker ⇒ Center speaker ⇒ Front right speaker ⇒ Surround right speaker ⇒ Surround left speaker ⇒ (back to the beginning)

Setting DVD preferences

■ Delay menu (DELAY)

Example:

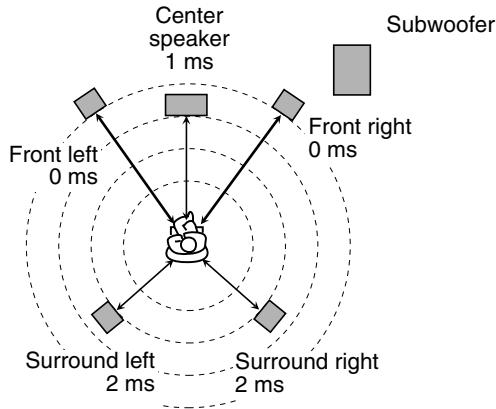

In this case, set the delay time of each speaker as follows;

- Delay time of front speakers: 0 ms
- Delay time of center speaker: 1 ms
- Delay time of surround speakers: 2 ms

FRONT LEFT SPEAKER/FRONT RIGHT SPEAKER/ CENTER SPEAKER/SURROUND RIGHT SPEAKER/ SURROUND LEFT SPEAKER

Adjust the distance from the listening position to the speakers.

Within the range from 0 ms to 15 ms. (by 1 ms)

■ Subwoofer menu (SUBWOOFER)

LEVEL

You can set the output level of the subwoofer in the -6 dB to +6 dB range.

CROSS OVER

The signals below the preset frequency level will be sent to and be reproduced by the subwoofer.

Select one of the cross over frequency levels according to the bass sound quality from the front/center/surround speakers.

Other setting menu (OTHERS)

■ RESUME (See page 25.)

You can activate or deactivate Resume Playback function.

■ ON SCREEN GUIDE

You can activate or deactivate the on-screen guide icons. (See page 16.)

■ DivX registration menu (DivX REGISTRATION)

The system has its own Registration Code for DivX playback.

You can confirm the code of your system.

- Once you played back a disc created by using the Registration Code, the system's code is overwritten by a totally different new one for copyright protection purpose.

Tuner operations

The buttons described below are used on pages 34 to 37.

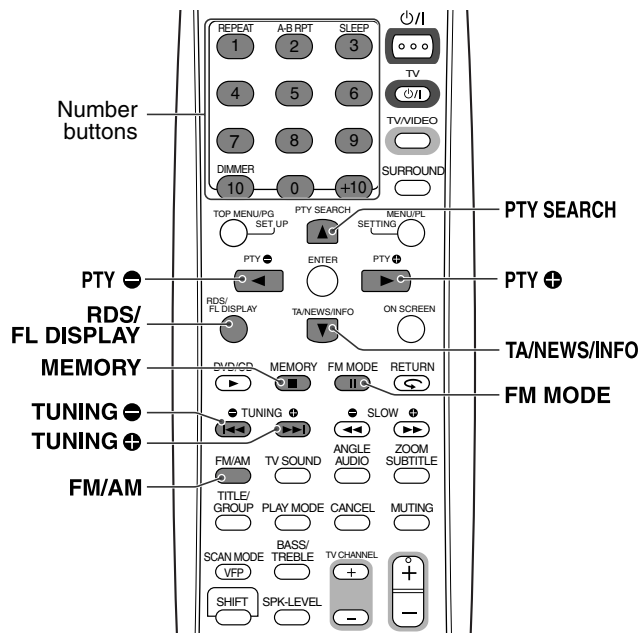

Manual tuning

1 Press FM/AM repeatedly to select the band.

Example:

When the system is tuned in to 810 kHz.

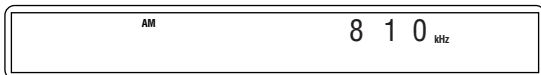

2 Press TUNING +/- repeatedly until you find the frequency you want.

When you hold down the button until the system starts searching for stations and then release it, the system stops searching automatically when a station of sufficient signal strength is tuned in to.

NOTE

- When an FM stereo program is received, the ST indicator lights on the display window.

Preset tuning

Once a station is assigned to a channel number, the station can be quickly tuned in. You can preset 30 FM and 15 AM (MW) stations.

To preset the stations

1 Tune in the station you want to preset.

- If you want to store the FM reception mode for an FM station, select the reception mode you want. See "Selecting the FM reception mode". (See page 35.)

Example:

When the system is tuned in to 103.5 MHz.

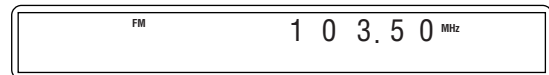

2 Press MEMORY.

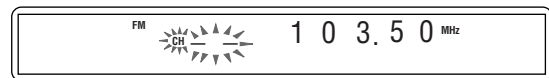

While "—" are flashing:

3 Press number button(s) (1-10, +10) to select a preset number you want.

- For details on using the number buttons, see "How to use the number buttons". (See page 18.)

Example:

When the preset channel 1 is selected.

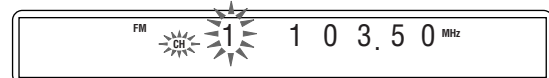

If the setting is cancelled before you finish, start from step 2 again.

While the selected number is flashing:

4 Press MEMORY.

The selected number stops flashing.

The station is assigned to the selected preset number.

If the setting is cancelled before you finish, start from step 2 again.

5 Repeat steps 1 to 4.

- Storing a new station to a used number erases the previously stored one.

To tune in to a preset station

1 Press FM/AM repeatedly to select FM or AM.

2 Press number button(s) (1-10, +10) to select a preset number.

- For details on using the number buttons, see "How to use the number buttons". (See page 18.)

Selecting the FM reception mode

When the stereo FM program currently tuned in is noisy, you can change the FM reception mode to improve the reception.

- While listening to an FM station

Press FM MODE.

The FM reception mode appears on the display window.

Each time you press the button, the FM reception mode changes.

- **AUTO:**

When a program is broadcast in stereo, you will hear stereo sound. (The ST indicator lights on the display window.) When in monaural, you will hear monaural sound. This mode is also useful to suppress static noise between stations.

- **MONO:**

Reception will be improved although you will lose the stereo effect. (The MONO indicator lights on the display window.) In this mode, you will hear noise until you are tuned in to a station.

Using the RDS (Radio Data System) when receiving FM stations

RDS allows FM stations to send an additional signal along with their regular program signals. For example, the stations send their station names, as well as information about what type of program they broadcast, such as sports or music, etc.

When tuned in to an FM station which provides the RDS service, the RDS indicator lights up on the display window.

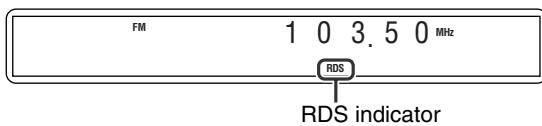

With the system, you can receive the following types of RDS signals:

PS (Program Service):	Shows commonly known station names.
PTY (Program Type):	Shows types of broadcast programs.
RT (Radio Text):	Shows text messages the station sends.
Enhanced Other Network:	See page 37.

NOTE

- RDS is not available for AM (MW) broadcasts.
- RDS may not operate correctly if the station tuned is not transmitting RDS signal properly or if the signal strength is weak.

■ To show the RDS signals information

Press RDS/FL DISPLAY while listening to an FM station.

Each time you repeat the procedure, the indication on the display window changes.

PS (Program Service):

While searching, "PS" appears and then the station names will be displayed. "NO PS" appears if no signal is sent.

PTY (Program Type):

While searching, "PTY" appears and then the type of the broadcast program will be displayed. "NO PTY" appears if no signal is sent.

RT (Radio Text):

While searching, "RT" appears and then text messages the station sends will be displayed. "NO RT" appears if no signal is sent.

Frequency:

Station frequency (non-RDS service).

About characters shown on the display window

When PS, PTY, or RT signals appear on the display window, some special characters and marks may not be displayed correctly.

NOTE

- If searching finishes at once, "PS", "PTY", and "RT" will not appear on the display window.

Searching for a program by PTY codes

One of the advantages of the RDS service is that you can locate a particular kind of program from the preset channels (see page 34) by specifying the PTY codes.

■ To search for a program using the PTY codes

NOTE

Before you start operation;

- Press FM/AM on the remote control to select an FM station.
- The PTY Search is only applicable to preset stations.
- To stop searching any time during the process, press PTY SEARCH while searching.
- There is a time limit in doing the following steps. If the setting is canceled before you finish, start from step 1 again.

1 Press PTY SEARCH while listening to an FM station.

“PTY” and “SELECT” flash alternately on the display window.

While “PTY” and “SELECT” is flashing alternately:

2 Press PTY ⊕ or PTY ⊖ repeatedly until the PTY code you want appears on the display window.

- For details, see “Description of the PTY codes”.

While the PTY code selected in step 2 is still on the display window:

3 Press PTY SEARCH again.

While searching, “SEARCH” and the selected PTY code alternate on the display window.

The system searches 30 preset FM stations, stops when it finds the one you have selected, and tunes in that station.

To continue searching after the first stop

Press PTY SEARCH again while the indications on the display window are flashing.

If no program is found, “NO FOUND” appears on the display window.

Description of the PTY codes

NEWS:	News.
AFFAIRS:	Topical program expanding or enlarging upon the news — debate, or analysis.
INFO:	Programs the purpose of which is to impart advice in the widest sense.
SPORT:	Programs concerned with any aspect of sports.
EDUCATE:	Educational programs.
DRAMA:	All radio plays and serials.
CULTURE:	Programs concerning any aspect of national or regional culture, including language, theater, etc.
SCIENCE:	Programs about natural sciences and technology.
VARIED:	Used for mainly speech-based programs such as quizzes, panel games and personality interviews.
POP M:	Commercial music of current popular appeal.
ROCK M:	Rock music.
EASY M:	Current contemporary music considered to be “easy-listening”.
LIGHT M:	Instrumental music, and vocal or choral works.
CLASSICS:	Performances of major orchestral works, symphonies, chamber music, etc.
OTHER M:	Music not fitting into any of the other categories.
WEATHER:	Weather reports and forecasts.
FINANCE:	Stock Market reports, commerce, trading etc.
CHILDREN:	Programs targeted at a young audience.
SOCIAL:	Programs about sociology, history, geography, psychology and society.
RELIGION:	Religious programs.
PHONE IN:	Involving members of the public expressing their views either by phone or at a public forum.
TRAVEL:	Travel information.
LEISURE:	Programs about recreational activities.
JAZZ:	Jazz music.
COUNTRY:	Songs which originate from, or continue the musical tradition of the American Southern States.
NATION M:	Current popular music of the nation or region in that country’s language.
OLDIES:	Music from the so-called “golden age” of popular music.
FOLK M:	Music which has its roots in the musical culture of a particular nation.
DOCUMENT:	Programs concerning factual matters, presented in an investigative style.
TEST:	Broadcasts for testing emergency broadcast equipment or unit.
ALARM:	Emergency announcement.
NONE:	No program type, undefined program, or difficult to categorize into particular types.

NOTE

- Classification of the PTY codes for some FM stations may be different from the above list.

Switching to broadcast program of your choice temporarily

Another convenient RDS service is called “Enhanced Other Network”.

This allows the system to switch temporarily to a broadcast program of your choice (TA, NEWS, and/or INFO) from a different station except in the following cases:

- When you are listening to non-RDS stations (all AM – MW stations, some FM stations and other sources).
- When the system is in standby mode.

NOTE

Before you start operations;

- The Enhanced Other Network function is only applicable to preset stations.

Press TA/NEWS/INFO repeatedly until the program type indicator (TA/NEWS/INFO) you want appears on the display window.

Each time you repeat the procedure, the indicator on the display window changes.

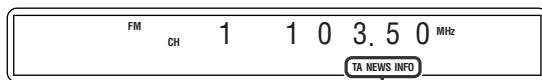

The program type indicator

TA: Traffic Announcement in your area.

NEWS: News.

INFO: Program the purpose of which is to impart advice in the widest sense.

To stop listening to the program selected by Enhanced Other Network

Press TA/NEWS/INFO repeatedly again so that the program type indicator (TA/NEWS/INFO) goes off from the display window. The system exits from Enhanced Other Network standby mode and goes back to the previously selected station.

When an emergency broadcast (Alarm signal) is sent from an FM station

The system automatically tunes in to the station and “ALARM” appears on the display window while the system receiving the emergency broadcast.

Note that an emergency broadcast cannot be received in the following cases;

- When you are listening to non-RDS stations (all AM — MW stations, some FM stations and other sources).
- When the system is in standby mode.

The TEST signal is used for equipment test — whether it can receive the Alarm signal correctly

The TEST signal makes the system work in the same way as the Alarm signal does. If the TEST signal is received, the system automatically switches to the station broadcasting the TEST signal. While receiving the TEST signal, “TEST” appears on the display window.

■ How the Enhanced Other Network function actually works

Case 1

If there is no station broadcasting the program you have selected

The system continues tuning in to the current station.



When a station starts broadcasting the program you have selected, the system automatically switches to the station. The indicator of received PTY code starts flashing.



When the program is over, the system goes back to the previously tuned station, but the Enhanced Other Network function still remains activated.

Case 2

If the FM station you are listening to is broadcasting the program you have selected

The system continues to receive the station but the indicator of received PTY code starts flashing.



When the program is over, the indicator of received PTY code stops flashing and remains lit, but the Enhanced Other Network function still remains activated.

NOTE

- In Enhanced Other Network standby mode, if you change the source to play, Enhanced Other Network standby mode is canceled temporarily. If you change the source to FM again, the system returns to Enhanced Other Network standby mode.
- Enhanced Other Network data sent from some stations may not be compatible with this system.
- Enhanced Other Network does not function for some FM stations with RDS service.
- While listening to a program tuned in by the Enhanced Other Network function, the station does not change even if another network station starts broadcasting a program of the same Enhanced Other Network data.
- While listening to a program tuned in by the Enhanced Other Network function, you can only use TA/NEWS/INFO and RDS/FL DISPLAY as the tuner operation buttons.

Maintenance

■ Handling Discs

- Remove the disc from its case by holding it at the edge while pressing the center hole lightly.
- Do not touch the shiny surface of the disc or bend the disc.
- Put the disc back in its case after use to prevent warping.
- Be careful not to scratch the surface of the disc when placing it back in its case.
- Avoid exposure to direct sunlight, temperature extremes and moisture.

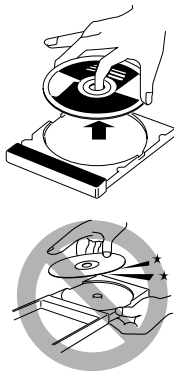

To clean the disc

Wipe the disc with a soft cloth in a straight line from center to edge.

- **DO NOT use any solvent — such as conventional record cleaner, spray, thinner or benzine — to clean the disc.**



■ Cleaning the system

- Stains on the system should be wiped off with a soft cloth. If the system is heavily stained, wipe it with a cloth soaked in water diluted neutral detergent and wrung well, then wipe clean with a dry cloth.
- Since the system may deteriorate in quality, become damaged or get its paint peeled off, be careful about the following.
 - DO NOT wipe it with a hard cloth.
 - DO NOT wipe it strong.
 - DO NOT wipe it with thinner or benzine.
 - DO NOT apply any volatile substance such as insecticides to it.
 - DO NOT allow any rubber or plastic to remain in contact with it for a long time.

Troubleshooting

PROBLEM	POSSIBLE CAUSE	SOLUTION
Power does not come on.	The power cord is not connected.	Connect the power cord correctly. (See page 11.)
The remote control does not work.	The batteries are exhausted.	Replace the batteries. (See page 6.)
	Sunlight is falling directly on the remote sensor.	Hide the remote sensor from direct sunlight.
The remote control does not work as expected.	The remote control mode is not for the desired source.	Before operation, press one of the source selecting buttons for the desired source.
No sound.	The speaker cord is not connected.	Check the connection. (See page 8.)
	An incorrect source has been selected.	Select the correct source. (See page 14.)
No picture is displayed on the TV screen.	The SCART cable is not connected correctly.	Connect the cable correctly. (See page 11.)
	The disc is not playable.	Use a playable disc. (See page 3.)
Video and audio are distorted.	The disc is scratched or dirty.	Replace or clean the disc.
	A VCR is connected between the center unit and the TV.	Connect the center unit and TV directly. (See page 11.)
The picture does not fit the TV screen.	The monitor type is not set correctly.	Set "MONITOR TYPE" properly. (See page 32.)
Hard to listen to broadcast because of noise.	Antennas are disconnected.	Reconnect the antennas correctly and securely. (See page 7.)
The system suddenly turns off.	The playback level of the current source is too high.	Play back the source with lower volume level.

Specifications

■ Center unit (XV-THS33/XV-THS11)

Audio section

Front/Center/Surround: 33 W per channel, RMS at 6 Ω at 1 kHz, with 10 % total harmonic distortion.
Subwoofer: 40 W, RMS at 4 Ω at 100 Hz, with 10% total harmonic distortion.

Video section

Video System: PAL
Horizontal Resolution: 500 lines
Signal-to-Noise Ratio: 64 dB
(Composite signal when "RGB" is selected)
Video output level
Composite: 1.0 V(p-p)/75 Ω
S-video-Y: 1.0 V(p-p)/75 Ω
S-video-C: 0.3 V(p-p)/75 Ω
RGB: 0.7 V(p-p)/75 Ω

Tuner section

Tuning Range
FM: 87.50 MHz to 108.00 MHz
AM: 522 kHz to 1 629 kHz

General

Power Requirements: AC 230 V \sim , 50 Hz
Power Consumption: 100 W (at operation)
1.3 W (in standby mode)
Dimensions (W \times H \times D):
360 mm \times 65 mm \times 370 mm
Mass: 5.3 kg

■ Front speakers (SP-THS33F)

Type: 1-Way Bass-Reflex Type
(Magnetically-shielded Type)
Speaker: 5.5 cm cone \times 1
Power Handling Capacity: 35 W
Impedance: 6 Ω
Frequency Range: 90 Hz to 20 000 Hz
Sound Pressure Level: 75 dB/W·m
Dimensions (W \times H \times D):
230 mm \times 1 102 mm \times 260 mm
Mass: 3.2 kg each

■ Center speaker (SP-THS33C)

Type: 1-Way Bass-Reflex Type
(Magnetically-shielded Type)
Speaker: 5.5 cm cone \times 2
Power Handling Capacity: 35 W
Impedance: 6 Ω
Frequency Range: 95 Hz to 20 000 Hz
Sound Pressure Level: 81 dB/W·m
Dimensions (W \times H \times D):
220 mm \times 84 mm \times 88.5 mm
Mass: 0.97 kg

■ Surround speakers (SP-THS33S)

Type: 1-Way Bass-Reflex Type
Speaker: 5.5 cm cone \times 1
Power Handling Capacity: 35 W
Impedance: 6 Ω
Frequency Range: 105 Hz to 20 000 Hz
Sound Pressure Level: 75 dB/W·m
Dimensions (W \times H \times D):
83 mm \times 131 mm \times 93.5 mm
Mass: 0.50 kg each

■ Subwoofer (SP-WS33)

Type: 1-Way Bass-Reflex Type
Speaker: 16.0 cm cone \times 1
Power Handling Capacity: 40 W
Impedance: 4 Ω
Frequency Range: 30 Hz to 150 Hz
Sound Pressure Level: 75 dB/W·m
Dimensions (W \times H \times D):
129 mm \times 284 mm \times 337 mm
Mass: 3.3 kg

■ Front speakers (SP-THS11F)

Type: 1-Way Bass-Reflex Type
(Magnetically-shielded Type)
Speaker: 8.0 cm cone \times 1
Power Handling Capacity: 33 W
Impedance: 6 Ω
Frequency Range: 90 Hz to 20 000 Hz
Sound Pressure Level: 84 dB/W·m
Dimensions (W \times H \times D):
92 mm \times 101 mm \times 95 mm
Mass: 0.58 kg each

■ Center speaker (SP-THS11C)

Type: 1-Way Bass-Reflex Type
(Magnetically-shielded Type)
Speaker: 8.0 cm cone \times 1
Power Handling Capacity: 33 W
Impedance: 6 Ω
Frequency Range: 90 Hz to 20 000 Hz
Sound Pressure Level: 85 dB/W·m
Dimensions (W \times H \times D):
92 mm \times 101 mm \times 95 mm
Mass: 0.65 kg

■ Surround speakers (SP-THS11S)

Type: 1-Way Bass-Reflex Type
Speaker: 8.0 cm cone \times 1
Power Handling Capacity: 33 W
Impedance: 6 Ω
Frequency Range: 90 Hz to 20 000 Hz
Sound Pressure Level: 82 dB/W·m
Dimensions (W \times H \times D):
92 mm \times 101 mm \times 95 mm
Mass: 0.56 kg each

■ Subwoofer (SP-WS11)

Type: 1-Way Bass-Reflex Type
Speaker: 15.0 cm cone \times 1
Power Handling Capacity: 40 W
Impedance: 4 Ω
Frequency Range: 40 Hz to 1 800 Hz
Sound Pressure Level: 84 dB/W·m
Dimensions (W \times H \times D):
129 mm \times 284 mm \times 337 mm
Mass: 3.0 kg

Designs & specifications are subject to change without notice.

JVC

