

# JVC



## DVD DIGITAL CINEMA SYSTEM

# TH-A30R

Consists of XV-THA30R, SP-XA30, SP-XSA30 and SP-WA30

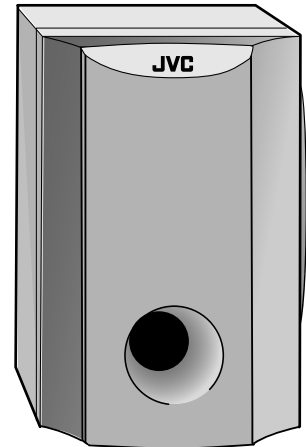
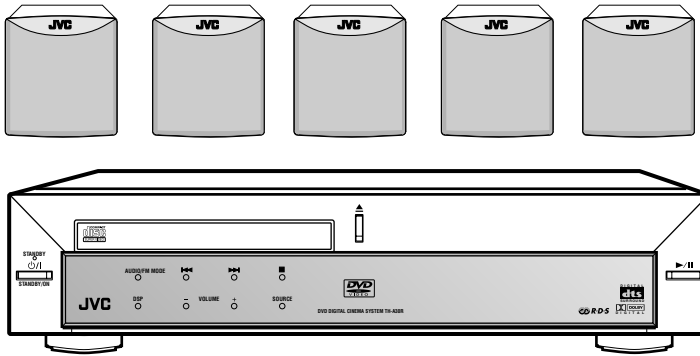

## INSTRUCTIONS

### For Customer Use:

Enter below the Model No. and Serial No. which are located either on the rear, bottom or side of the cabinet. Retain this information for future reference.

Model No. \_\_\_\_\_

Serial No. \_\_\_\_\_

LVT0945-010B

[B]

# Warnings, Cautions and Others

---

**IMPORTANT** for the U.K.

**DO NOT** cut off the mains plug from this equipment. If the plug fitted is not suitable for the power points in your home or the cable is too short to reach a power point, then obtain an appropriate safety approved extension lead or consult your dealer.

**BE SURE** to replace the fuse only with an identical approved type, as originally fitted.

If nonetheless the mains plug is cut off ensure to remove the fuse and dispose of the plug immediately, to avoid a possible shock hazard by inadvertent connection to the mains supply.

If this product is not supplied fitted with a mains plug then follow the instructions given below:

**IMPORTANT.**

**DO NOT** make any connection to the terminal which is marked with the letter E or by the safety earth symbol or coloured green or green-and-yellow.

The wires in the mains lead on this product are coloured in accordance with the following code:

Blue : Neutral  
Brown : Live

As these colours may not correspond with the coloured markings identifying the terminals in your plug proceed as follows:

The wire which is coloured blue must be connected to the terminal which is marked with the letter N or coloured black.

The wire which is coloured brown must be connected to the terminal which is marked with the letter L or coloured red.

**IF IN DOUBT - CONSULT A COMPETENT ELECTRICIAN.**

## **CAUTION**

To reduce the risk of electrical shocks, fire, etc.:

1. Do not remove screws, covers or cabinet.
2. Do not expose this appliance to rain or moisture.

## **Caution —STANDBY/ON switch!**

Disconnect the mains plug to shut the power off completely.

The STANDBY/ON  button in any position does not disconnect the mains line.

The power can be remote controlled.

## **CAUTION**

- Do not block the ventilation openings or holes.  
(If the ventilation openings or holes are blocked by a newspaper or cloth, etc., the heat may not be able to get out.)
- Do not place any naked flame sources, such as lighted candles, on the apparatus.
- When discarding batteries, environmental problems must be considered and local rules or laws governing the disposal of these batteries must be followed strictly.
- Do not expose this apparatus to rain, moisture, dripping or splashing and that no objects filled with liquids, such as vases, shall be placed on the apparatus.

## IMPORTANT FOR LASER PRODUCTS

### REPRODUCTION OF LABELS

① CLASSIFICATION LABEL, PLACED ON EXTERIOR SURFACE

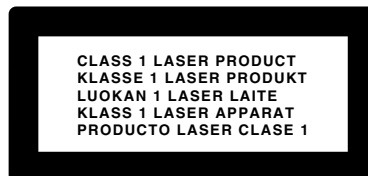

② WARNING LABEL, PLACED INSIDE THE UNIT

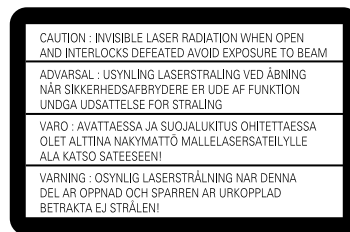

1. CLASS 1 LASER PRODUCT
2. **CAUTION:** Invisible laser radiation when open and interlock failed or defeated. Avoid direct exposure to beam.
3. **CAUTION:** Do not open the top cover. There are no user serviceable parts inside the Unit; leave all servicing to qualified service personnel.

#### Caution: Proper Ventilation

To avoid risk of electric shock and fire and to protect from damage.

Locate the apparatus as follows:

- Front: No obstructions open spacing.
- Sides: No obstructions in 10 cm from the sides.
- Top: No obstructions in 10 cm from the top.
- Back: No obstructions in 15 cm from the back
- Bottom: No obstructions, place on the level surface.

In addition, maintain the best possible air circulation as illustrated.

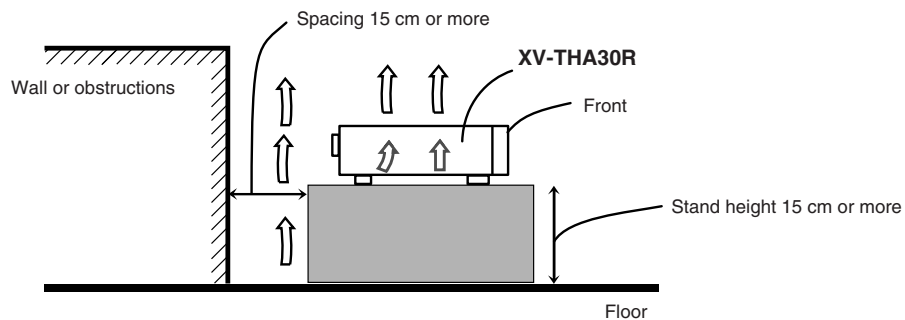

## SAFETY INSTRUCTIONS

### “SOME DOS AND DON'TS ON THE SAFE USE OF EQUIPMENT”

This equipment has been designed and manufactured to meet international safety standards but, like any electrical equipment, care must be taken if you are to obtain the best results and safety is to be assured.

\*\*\*\*\*

Do read the operating instructions before you attempt to use the equipment.

Do ensure that all electrical connections (including the mains plug, extension leads and interconnections between pieces of equipment) are properly made and in accordance with the manufacturer's instructions. Switch off and withdraw the mains plug when making or changing connections.

Do consult your dealer if you are ever in doubt about the installation, operation or safety of your equipment.

Do be careful with glass panels or doors on equipment.

\*\*\*\*\*

DON'T continue to operate the equipment if you are in any doubt about it working normally, or if it is damaged in any way—switch off, withdraw the mains plug and consult your dealer.

DON'T remove any fixed cover as this may expose dangerous voltages.

DON'T leave equipment switched on when it is unattended unless it is specifically stated that it is designed for unattended operation or has a standby mode.

Switch off using the switch on the equipment and make sure that your family know how to do this.

Special arrangements may need to be made for infirm or handicapped people.

DON'T use equipment such as personal stereos or radios so that you are distracted from the requirements of traffic safety. It is illegal to watch television whilst driving.

DON'T listen to headphones at high volume as such use can permanently damage your hearing.

DON'T obstruct the ventilation of the equipment, for example with curtains or soft furnishings.

Overheating will cause damage and shorten the life of the equipment.

DON'T use makeshift stands and NEVER fix legs with wood screws — to ensure complete safety always fit the manufacturer's approved stand or legs with the fixings provided according to the instructions.

DON'T allow electrical equipment to be exposed to rain or moisture.

ABOVE ALL

— NEVER let anyone, especially children, push anything into holes, slots or any other opening in the case -this could result in a fatal electrical shock.;

— NEVER guess or take chances with electrical equipment of any kind — it is better to be safe than sorry!

# Table of Contents

<b>Parts Identification</b> .....	<b>2</b>	Moving to a Particular Portion Directly .....	29
Center Unit .....	2	Searching for a Particular Point .....	30
Remote Control .....	3	Repeating Playback .....	30
<b>Getting Started</b> .....	<b>4</b>	■ Repeat Play .....	30
Before Installation .....	4	■ A-B Repeat .....	30
Checking the Supplied Accessories .....	4	Programming the Playing Order of the Chapters	
Putting Batteries in the Remote Control .....	4	—Program Play .....	31
Connecting the FM and AM Antennas .....	5	DVD Special Effect Playback .....	33
Speaker Layout Diagram .....	6	■ Still Picture/Frame-by-Frame Playback .....	33
Connecting the Speakers .....	7	■ Slow Motion Playback .....	33
Connecting Audio/Video Component .....	8	■ Zoom .....	33
<b>Basic DVD Operations</b> .....	<b>10</b>	<b>VCD/CD Playback</b> .....	<b>34</b>
1 Turn On the Power .....	10	Showing the On-Screen Bar .....	34
2 Select the Source .....	10	Checking the Remaining Time .....	34
3 Load a DVD .....	10	Disc Menu-Driven Playback (Only for VCD) .....	35
4 Start Playback .....	10	Moving to a Particular Portion Directly .....	35
5 Adjust the Volume .....	10	Searching for a Particular Point .....	35
6 Activate Surround or DSP Mode .....	11	Repeating Playback .....	36
7 Stop Playback .....	11	■ Repeat Play .....	36
<b>Basic VCD/CD Operations</b> .....	<b>12</b>	■ A-B Repeat .....	36
1 Turn On the Power .....	12	Programming the Playing Order of the Tracks	
2 Select the Source .....	12	—Program Play .....	37
3 Load a VCD/CD .....	12	Selecting Playback Channel .....	38
4 Start Playback .....	12	VCD Special Effect Playback .....	39
5 Adjust the Volume .....	12	■ Still Picture/Frame-by-Frame Playback .....	39
6 Activate DSP Mode .....	13	■ Slow Motion Playback .....	39
7 Stop Playback .....	13	■ Zoom .....	39
<b>Basic Tuner Operations</b> .....	<b>14</b>	<b>MP3 Introduction</b> .....	<b>40</b>
1 Turn On the Power .....	14	<b>MP3 Playback</b> .....	<b>41</b>
2 Select the Band .....	14	Starting Playback .....	41
3 Adjust the Volume .....	14	Operations Using the On-Screen Display .....	42
4 Tune into a Station .....	14	Moving to a Particular Track Directly .....	43
<b>Other Basic Operations</b> .....	<b>15</b>	Repeating Playback .....	43
Enjoying Sounds from the External Component .....	15	<b>Tuner Operations</b> .....	<b>44</b>
Turning Off the Power with the Timer .....	15	Tuning in Stations .....	44
<b>Speaker Settings</b> .....	<b>16</b>	Using Preset Tuning .....	45
Setting the Delay Time .....	16	Selecting the FM Reception Mode .....	45
<b>Creating Realistic Sound Fields</b> .....	<b>18</b>	Using the RDS (Radio Data System)	
■ Dolby Digital and DTS Digital Surround .....	18	to Receive FM Stations .....	46
■ Dolby Surround .....	18	Searching for a Program by PTY Codes .....	47
■ DSP (Digital Signal Processor) Modes .....	19	■ Description of the PTY codes .....	48
Adjusting Stereo Sound .....	20	<b>Setting up the DVD Preferences</b> .....	<b>50</b>
Adjusting Dolby Digital and DTS Digital Surround .....	21	Setting the Initial Languages .....	50
Activating Dynamic Range Compression .....	21	Introducing the DVD Preference (System) .....	51
Adjusting Dolby Surround .....	22	Setting the Parental (Rating) Level .....	53
Adjusting DSP Modes .....	23	<b>Operating JVC's Components</b> .....	<b>54</b>
<b>Disc Introduction—DVD/VCD/CD</b> .....	<b>25</b>	<b>Operating Other Manufacturers' TV</b> .....	<b>55</b>
<b>Basic Disc Operations</b> .....	<b>26</b>	<b>Maintenance</b> .....	<b>56</b>
<b>DVD Playback</b> .....	<b>27</b>	<b>Troubleshooting</b> .....	<b>57</b>
Showing the On-Screen Bar .....	27	<b>Specifications</b> .....	<b>58</b>
Selecting the Subtitles .....	28		
Selecting the Audio Languages .....	28		
Selecting the Multi-Angle Views .....	28		
Checking the Remaining Time .....	29		
Disc Menu-Driven Playback .....	29		

# Parts Identification

## Center Unit

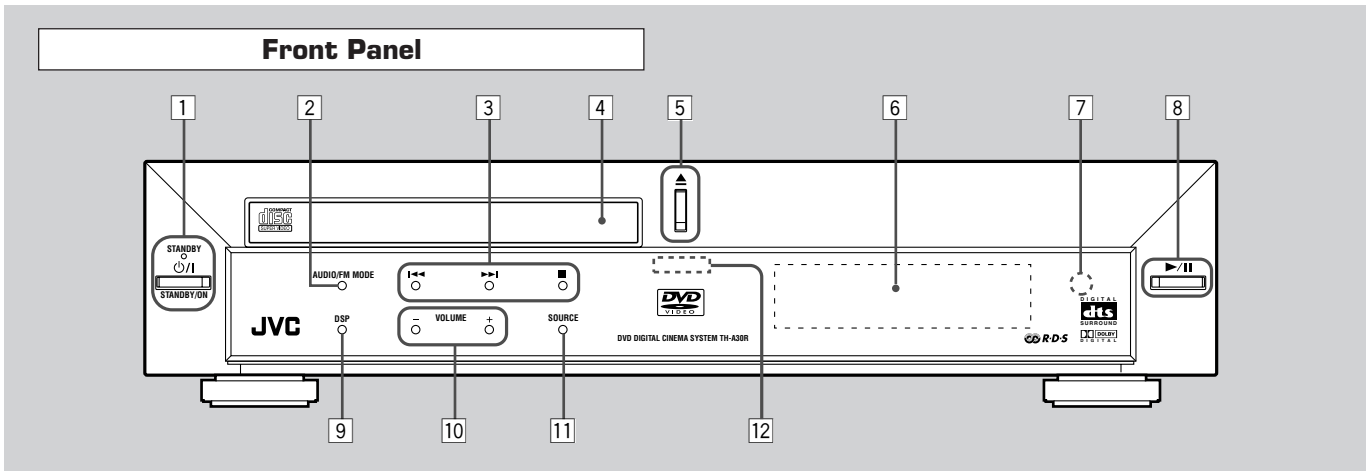

See pages in the parentheses for details.

### Front Panel

- |   |   |
|---|---|
| <p>1 STANDBY/ON <math>\odot/\text{I}</math> button and STANDBY lamp (10 – 14)</p> <p>2 AUDIO/FM MODE button (28, 38, 45)</p> <p>3 Multi operation buttons</p> <ul style="list-style-type: none"> <li>• <math>\lll</math>, <math>\ggg</math>, and <math>\blacksquare</math></li> </ul> <p>4 Disc tray (10, 12)</p> <p>5 <math>\blacktriangle</math> (open/close) button (10 – 13, 32, 37, 41)</p> <ul style="list-style-type: none"> <li>• Pressing this button also turns on the power and changes the source to the DVD player.</li> </ul> <p>6 Display window</p> | <p>7 Remote sensor</p> <p>8 <math>\blacktriangleright/\text{II}</math> (play/pause) button (10, 12, 26, 41)</p> <ul style="list-style-type: none"> <li>• Pressing this button also turns on the power and changes the source to the DVD player.</li> </ul> <p>9 DSP button (11, 13, 23)</p> <p>10 VOLUME + and – buttons (10, 12, 14)</p> <p>11 SOURCE button (14, 15, 44, 45)</p> <p>12 Illumination lamp (10, 12, 14)</p> |
|---|---|

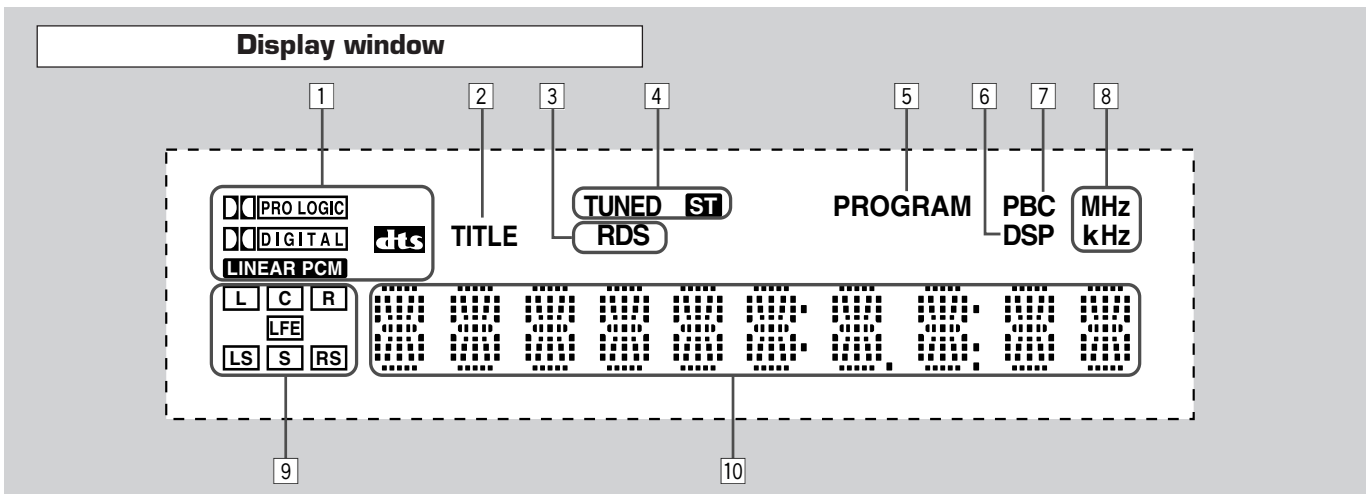

See pages in the parentheses for details.

### Display

- |   |   |
|---|---|
| <p>1 Sound signal indicators (11, 13, 18)</p> <ul style="list-style-type: none"> <li>• PRO LOGIC, DOLBY DIGITAL, DTS, and LINEAR PCM</li> </ul> <p>2 TITLE indicator (26)</p> <p>3 RDS indicator (46)</p> <p>4 Tuner mode indicators (14, 44, 45)</p> <ul style="list-style-type: none"> <li>• TUNED and ST (stereo)</li> </ul> <p>5 PROGRAM indicator (31, 37, 45)</p> | <p>6 DSP indicator (23)</p> <p>7 PBC (Play Back Control) indicator (34)</p> <p>8 Frequency unit indicators</p> <ul style="list-style-type: none"> <li>• MHz (for FM station) and kHz (for AM station)</li> </ul> <p>9 Audio channel indicators</p> <ul style="list-style-type: none"> <li>• Indicates audio channels currently being played back.</li> </ul> <p>10 Main display</p> |
|---|---|

## Remote Control

### Remote Control

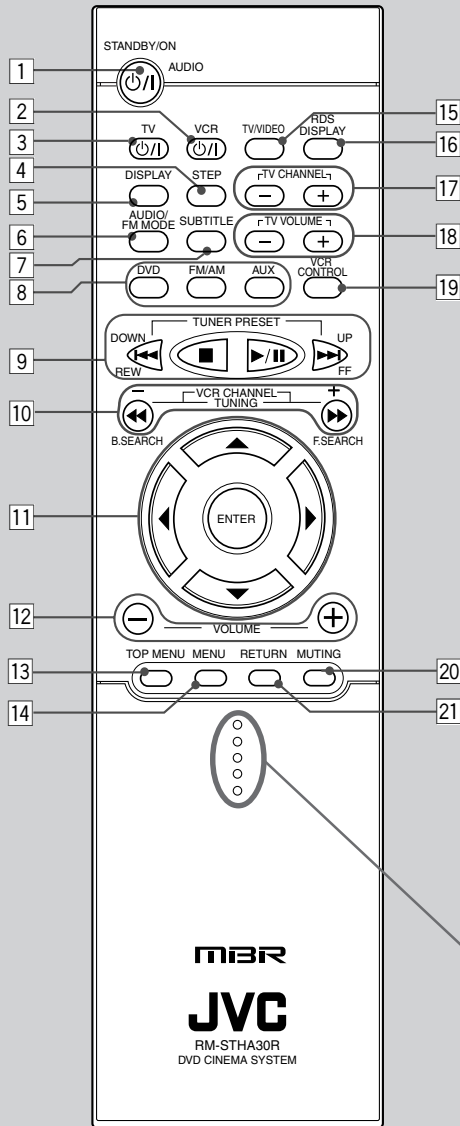

See pages in the parentheses for details.

- 1 STANDBY/ON  $\odot/\text{II}$  AUDIO button (10 – 14)
- 2 VCR  $\odot/\text{II}$  button (54)
- 3 TV  $\odot/\text{II}$  button (10, 12, 54, 55)
- 4 STEP button (33, 39)
- 5 DISPLAY button (27, 34)
- 6 AUDIO/FM MODE button (28, 38, 45)
- 7 SUBTITLE button (28)
- 8 Source selecting buttons (14, 15, 44)
  - DVD, FM/AM, AUX
  - Pressing one of these buttons also turns on the power.
- 9  $\blacktriangleleft$ ,  $\blacksquare$ ,  $\blacktriangleright$ ,  $\text{II}$ , and  $\blacktriangleright$  buttons  
TUNER PRESET UP and DOWN buttons (45)  
FF (Fast-forward) and REW (Rewind) buttons
- 10 VCR CHANNEL + and – buttons (54)  
TUNING + and – buttons (14, 44)  
 $\blacktriangleright$  F. (Forward) SEARCH and  $\blacktriangleleft$  B. (Back) SEARCH buttons
- 11 Menu operation buttons
  - $\blacktriangleright$ ,  $\blacktriangleleft$ ,  $\blacktriangle$ , and  $\blacktriangledown$  buttons
  - ENTER button
- 12 VOLUME + and – buttons (10, 12, 14)
- 13 TOP MENU button (29)
- 14 MENU button (29, 35)
- 15 TV/VIDEO button (10, 12, 54, 55)
- 16 RDS DISPLAY button (46)
- 17 TV CHANNEL + and – buttons (54, 55)
- 18 TV VOLUME + and – buttons (54, 55)
- 19 VCR CONTROL buttons (54)

#### IMPORTANT:

If you press VCR CONTROL, this remote control will work ONLY for the JVC's VCR. When you want to operate the system again, press DVD or FM/AM.

- 20 MUTING button (10, 13)
- 21 RETURN button (35, 51, 52)

To open the cover of the remote control, push here, then slide downward.

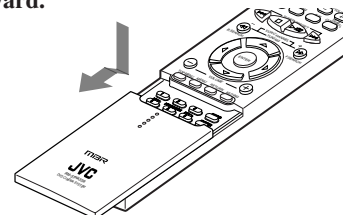

### Inside of the Cover

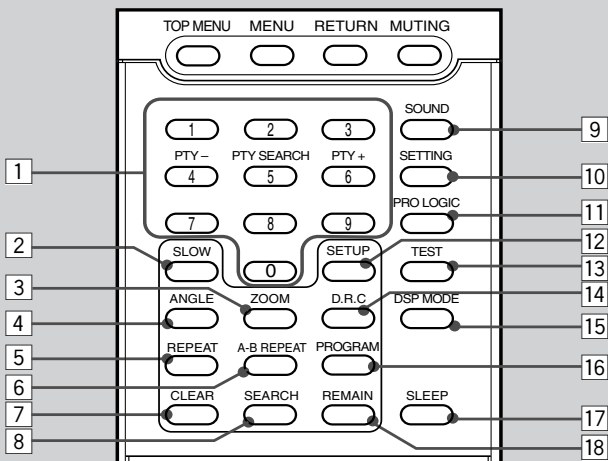

#### Inside of the Cover

- 1 Number buttons (29, 35, 43, 54, 55)
- 2 SLOW button (33, 39)
- 3 ZOOM button (33, 39)
- 4 ANGLE button (28)
- 5 REPEAT button (30, 36, 43)
- 6 A-B REPEAT button (31, 36)
- 7 CLEAR button (29, 35, 38)
- 8 SEARCH button (29, 35, 43)
- 9 SOUND button (20 – 24)
- 10 SETTING button (16, 17)
- 11 PRO LOGIC button (15, 17, 22)
- 12 SETUP button (51 – 53)
- 13 TEST button (19)
- 14 D.R.C button (21)
- 15 DSP MODE button (11, 13, 20, 23)
- 16 PROGRAM button (31, 32, 37, 45)
- 17 SLEEP button (15)
- 18 REMAIN button (29, 34)

# Getting Started

## Before Installation

### General Precautions

- DO NOT insert any metal object into the center unit.
- DO NOT disassemble the center unit or remove screws, covers, or cabinet.
- DO NOT expose the center unit to rain or moisture.

### Locations

- Install the center unit in a location that is level and protected from moisture.
- The temperature around the center unit must be between 5°C and 35°C (41°F and 95°F).
- Make sure there is good ventilation around the center unit. Poor ventilation could cause overheating and damage the center unit.

### Handling the center unit

- DO NOT touch the power cord with wet hands.
- DO NOT pull on the power cord to unplug the cord. When unplugging the cord, always grasp the plug so as not to damage the cord.
- Keep the power cord away from the connecting cords and the antenna. The power cord may cause noise or screen interference. It is recommended to use a coaxial cable for antenna connection, since it is well-shielded against interference.
- When a power failure occurs, or when you unplug the power cord, the preset settings such as preset FM/AM channels and sound adjustments may be erased in a few days.

## Checking the Supplied Accessories

Check to be sure you have all of the following supplied accessories. The number in the parentheses indicates the quantity of the pieces supplied.

- Remote Control (1)
- Batteries (2)
- AM Loop Antenna (1)
- FM Antenna (1)
- Video cord (1)

If anything is missing, contact your dealer immediately.

## Putting Batteries in the Remote Control

Before using the remote control, put two supplied batteries first.

- When using the remote control, aim the remote control directly at the remote sensor on the center unit.

1. On the back of the remote control, remove the battery cover.

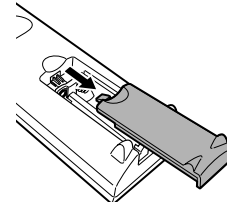

2. Insert batteries. Make sure to match the polarity: (+) to (+) and (-) to (-).

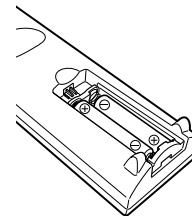

3. Replace the cover.

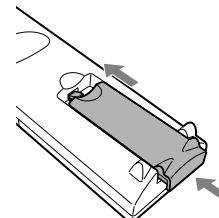

If the range or effectiveness of the remote control decreases, replace the batteries. Use two UM-4“AAA”/IEC “R03” type dry-cell batteries.

### CAUTION:

Follow these precautions to avoid leaking or cracking cells:

- Place batteries in the remote control so they match the polarity: (+) to (+) and (-) to (-).
- Use the correct type of batteries. Batteries that look similar may differ in voltage.
- Always replace both batteries at the same time.
- Do not expose batteries to heat or flame.



## Connecting the FM and AM Antennas

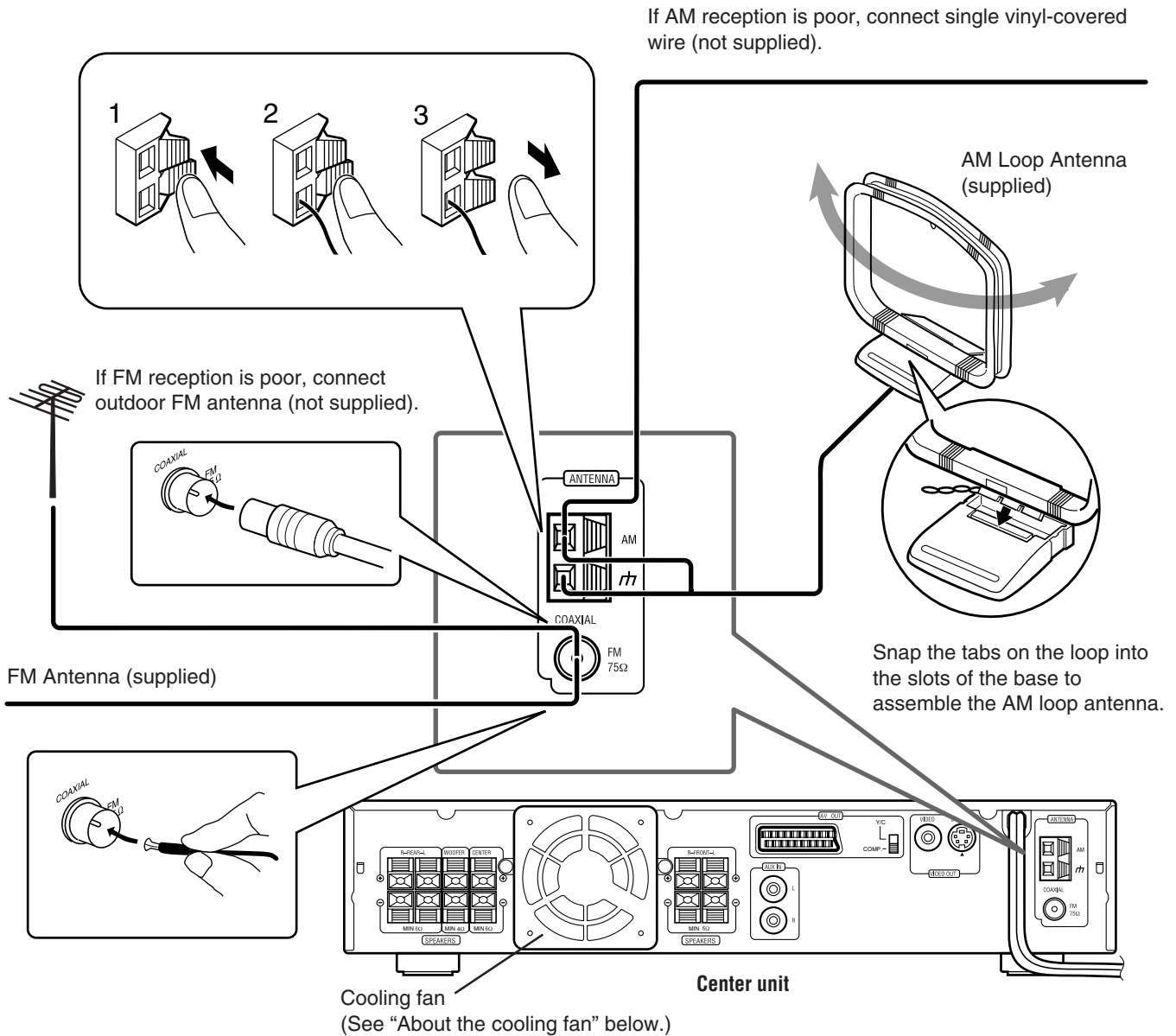

### FM antenna connection

Connect the supplied FM antenna to the FM 75 Ω COAXIAL terminal as temporary measure.

Extend the supplied FM antenna horizontally.

- If reception is poor, connect an outdoor antenna. Before attaching a 75 Ω coaxial cable (with a standard type connector), disconnect the supplied FM antenna.

### AM antenna connection

Connect the supplied AM loop antenna to the AM and  $\pi$  terminals. Turn the loop until you have the best reception.

- If reception is poor, connect an outdoor single vinyl-covered wire to the AM terminal. (Keep the AM loop antenna connected.)

#### Note:

If the AM loop antenna wire is covered with vinyl, remove the vinyl by twisting it as shown in the diagram.



### About the cooling fan

A cooling fan is mounted on the rear panel of the center unit to prevent abnormal temperature inside the center unit, thus assuring normal operation of the unit. The cooling fan automatically starts rotating to supply external cool air to the inside of the center unit when the internal temperature goes up.

For safety, observe the following carefully.

- Make sure there is good ventilation around the center unit. Poor ventilation could overheat and damage the center unit.
- DO NOT block the cooling fan and the ventilation openings or holes. (If they are blocked by a newspaper or cloth, etc., the heat may not be able to get out.)
- DO NOT touch the speaker cords to the cooling fan.

# Getting Started

## Speaker Layout Diagram

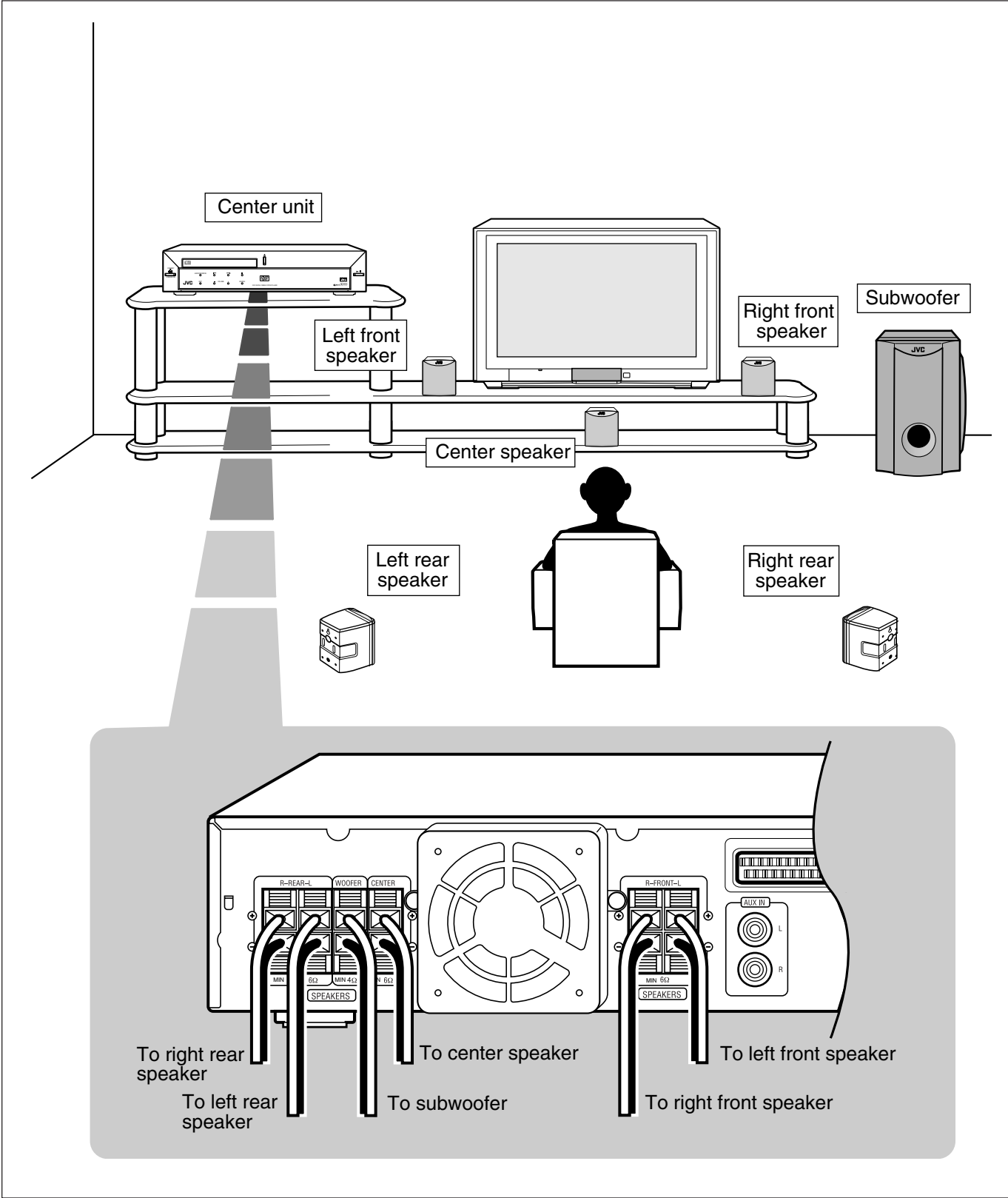

## Connecting the Speakers

Connect the satellite speakers, center speaker, and subwoofer to the terminals on the rear panel using speaker cords supplied.

Labels are attached to the speaker cords to indicate the terminals to be connected.

- Connect the red cord to the red (+) terminal, and the black cord to the black (-) terminal respectively.

### CAUTION:

Use speakers with the SPEAKER IMPEDANCE indicated by the speaker terminals.

### Connecting speaker cords to the terminals

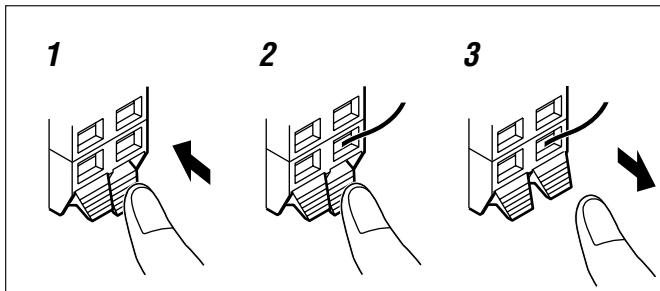

- 1 Press and hold the terminal clamp.
- 2 Insert the speaker cord.
- 3 Release the finger from the clamp.

### Notes:

- If the speaker cord is covered with vinyl, remove the vinyl by twisting it as shown in the diagram.
- Make sure the core wire of speaker cords do not expose to out of the terminals. This could cause short-circuit.



### When setting the speakers

To obtain the best possible sound from this system, you need to place all the speakers except the subwoofer at the same distance from the listening position with each front faced toward the listener. Since bass sound is non-directional, you can place a subwoofer wherever you like. Normally place it in front of you.

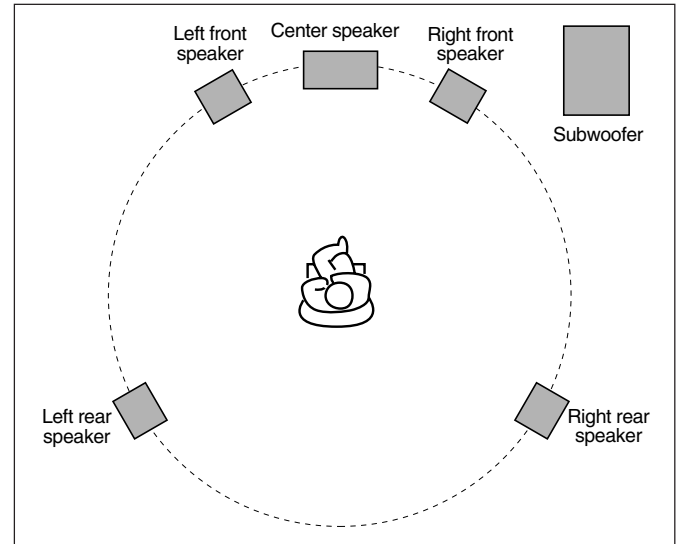

### If your speakers cannot be placed at the same distance from the listening position

You can adjust the delay time of the center speaker and rear speakers. For in-depth information about adjusting the delay time, see "Setting the Delay Time" on page 16 and 17.

### Note:

You can change the phase of subwoofer sounds by connecting the speaker cords to the terminals inversely—the red cord to the black terminal, and the black cord to the red terminal. You may get the more effective bass sounds by changing the phase.

### CAUTION:

- When attaching the satellite speakers on the wall, have them attached to the wall by a qualified person.  
DO NOT attach the satellite speakers on the wall by yourself to avoid an unexpected damage of their falling from the wall, caused by incorrect attachment or weakness in the wall.
- Care is required in selecting a location for attaching speakers to the wall. Injury to personnel, or damage to equipment, may result if the speakers are attached in a location which interferes with daily activities.

# Getting Started

## Connecting Audio/Video Component

Turn the power off to all components before connections.

### Audio component connection

Connect the other component to the center unit with the audio cord.  
Use the cord supplied with the other component or purchase it at an electric appliance store.

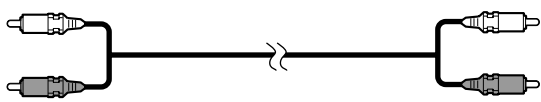

Audio cord (not supplied)

Illustrations of the input/output terminals below are typical examples.  
When you connect the other component, refer also to its manuals since the terminal name actually printed on the rear vary among the components.

If you connect a sound-enhancing device such as a graphic equalizer between the source component and the center unit, the sound output through this system may be distorted.

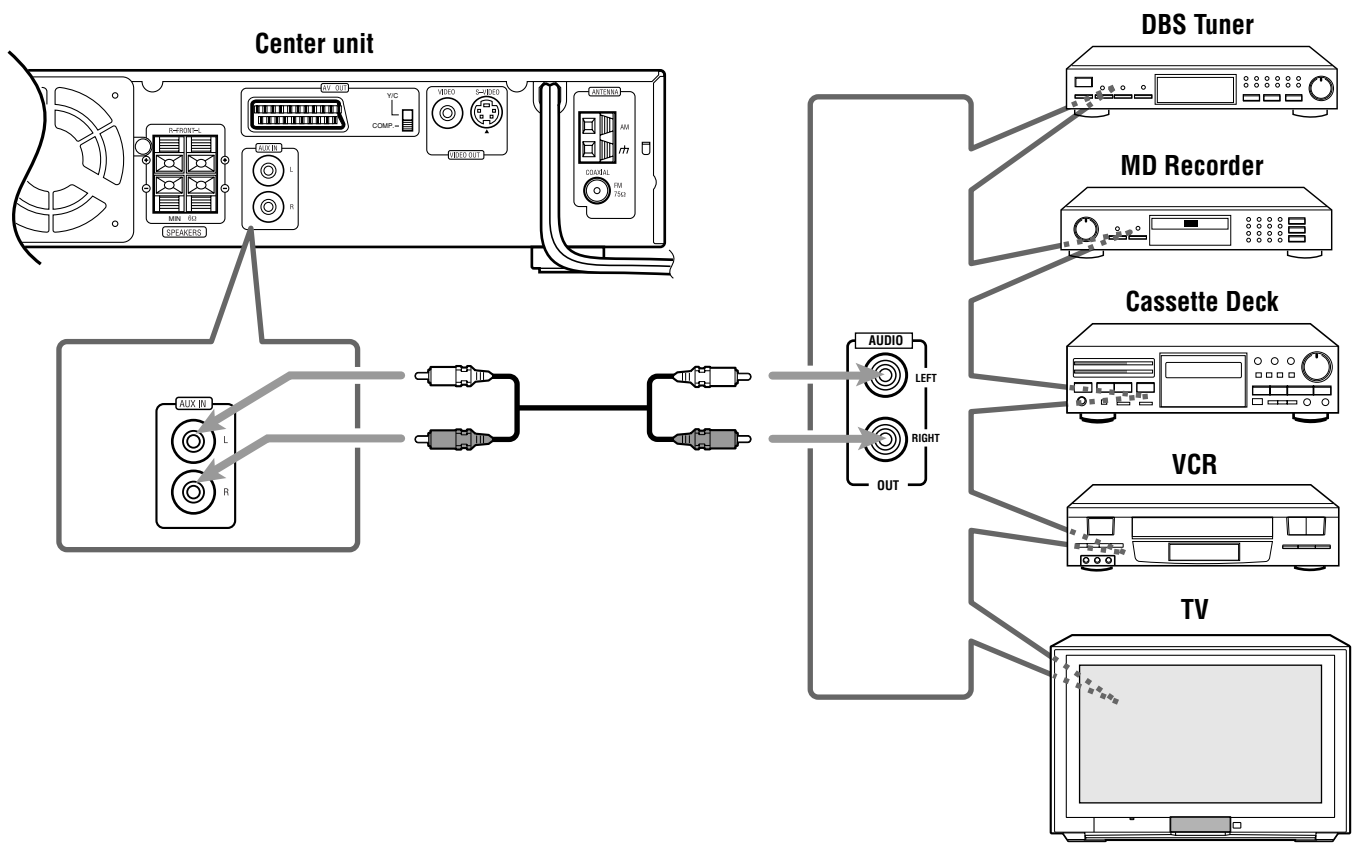

## TV connection

The S-video cord and the SCART cable are not supplied with this system.  
Use the cords or cables supplied with the other component or purchase them at an electric appliance store.

**A** Video cord (supplied)

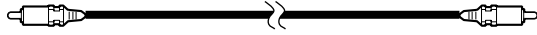

**B** S-video cord (not supplied)

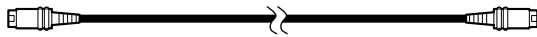

**C** SCART cable (not supplied)

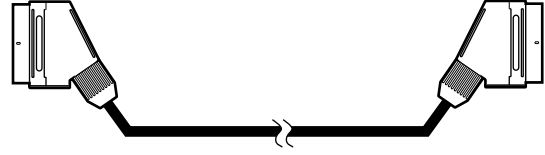

You can select one of three connection types—**A**, **B**, and **C**.

### For using the composite video cord or S-video cord

- If your TV has S-video (Y/C-separation) jack, connect it using an S-video cord (not supplied) **B**.  
By using this jack, you can get a better picture quality than using composite video cord connection **A**.

### For using the SCART cable ( **C** )

- If S-Video (Y/C-separation) is equipped for your TV, set Y/C-COMP. selector of the center unit to Y/C. You can get a better picture quality by using S-Video (Y/C-separation) setting.
- If S-Video (Y/C-separation) is not equipped for your TV, set Y/C-COMP. selector to COMP.

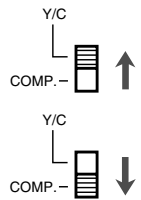

Illustrations below are typical examples. When you connect the TV, refer also to its manual since the terminal names actually printed on the rear vary among the components.

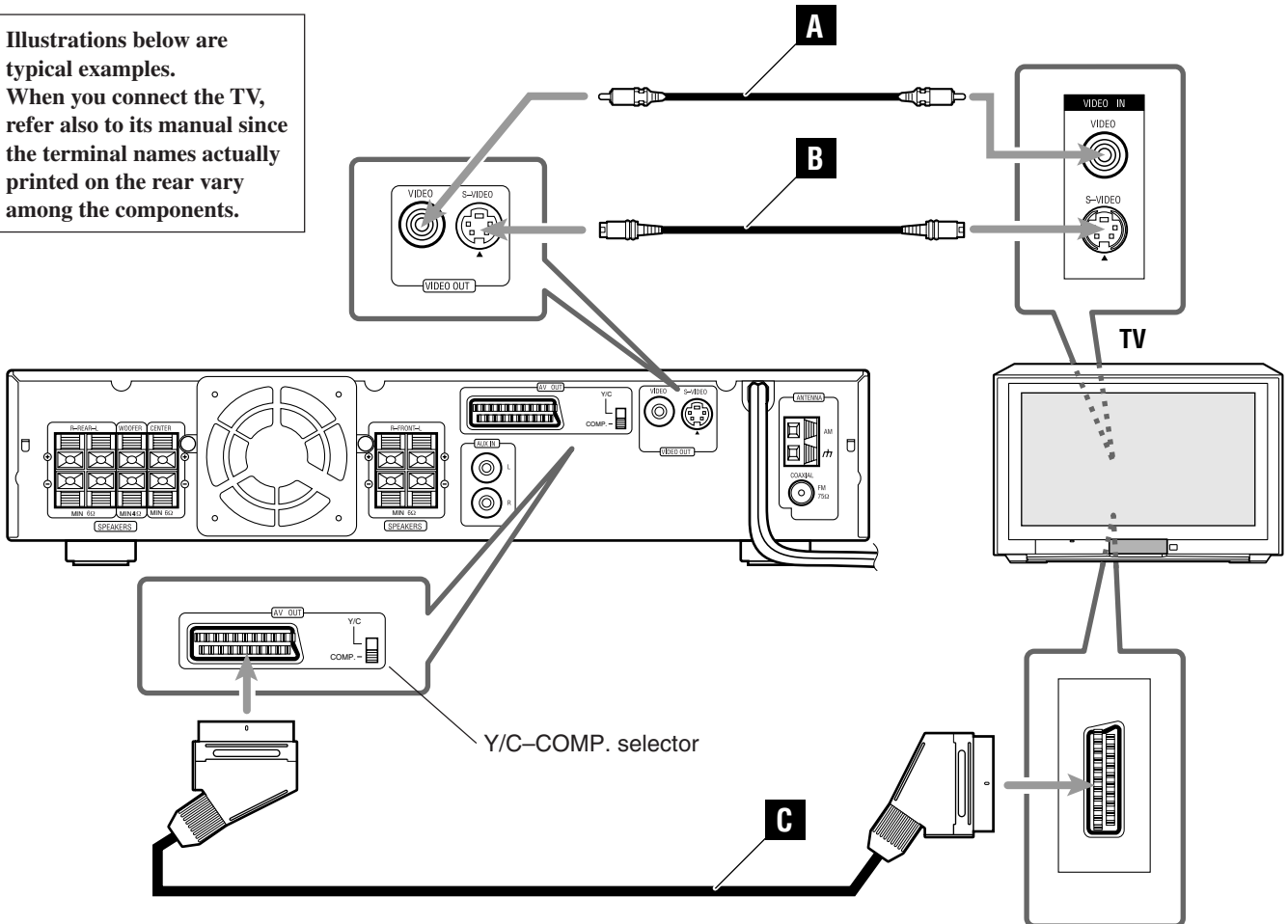

### Note:

On the rear panel SCART cable is indicated as "AV OUT." However, this terminal is designed as video output. So, no sound comes out.

Now, you can plug the power cord of the center unit into the AC outlet.

### Note:

Keep the power cord away from the connecting cords and the antenna cables. The power cord may cause noise or screen interference.

# Basic DVD Operations

This manual mainly explains operations using the buttons on the remote control. You can also use the buttons on the center unit if they have the similar names (or marks) as those on the remote control.

If operations using the center unit are different from those using the remote control, they are then explained.

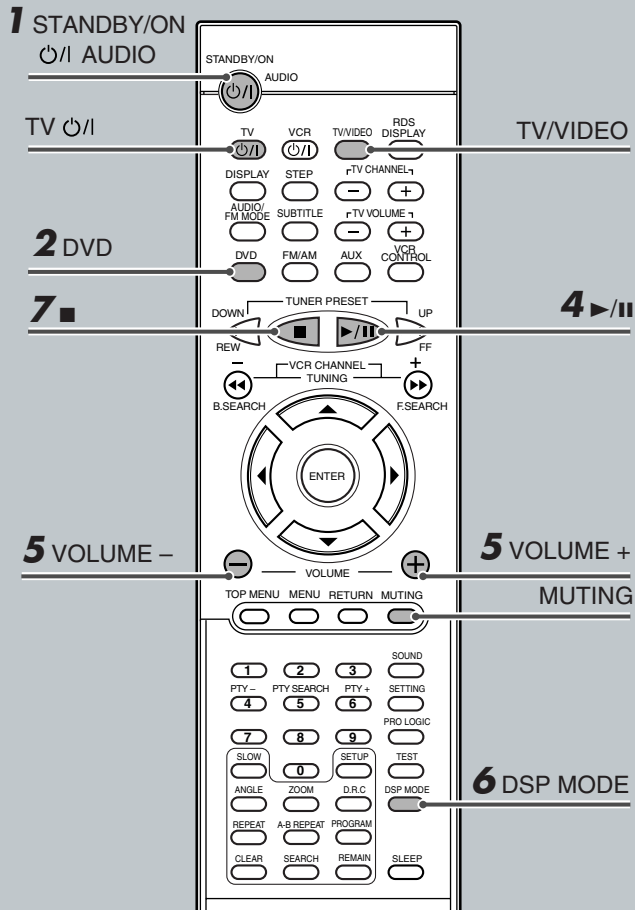

For in-depth information about DVD operations, see pages 25 to 33.

## 1 Turn On the Power

Before turning on the system, turn on your TV and select the correct video input. (See the manual supplied with your TV.)

- When you use a JVC's TV, you can turn on your TV by pressing TV on the remote control, and select the video input by pressing TV/VIDEO. (If your TV is not a JVC's, see "Operating Other Manufacturers' TV" on page 55.)
- For changing the OSD messages—the information on the TV screen—into the desired language, see "Setting the Initial Languages" on pages 50 and 51.

Press STANDBY/ON AUDIO (or STANDBY/ON on the front panel).

The STANDBY lamp goes off and the illumination lamp on the center unit lights up. The source indication selected previously appears on the display.



## 2 Select the Source

Press DVD.

The source changes to DVD.



## 3 Load a DVD

**On the front panel ONLY:**

Press to open the disc tray, then place a DVD correctly with its label side up.

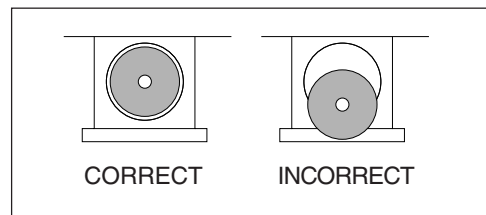

## 4 Start Playback

Press .

The disc tray closes. "LOADING" appears for a while.

- You can also start playback by closing the disc tray using on the front panel.

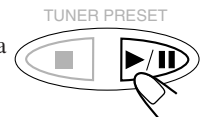

## 5 Adjust the Volume

To increase the volume, press and hold VOLUME +.  
To decrease the volume, press and hold VOLUME -.



### CAUTION:

Always set the volume to the minimum before starting any source. If the volume is set at its high level, the sudden blast of sound energy can permanently damage your hearing and/or ruin your speakers.

### Notes:

- By pressing VOLUME + or - repeatedly, you can adjust the volume level step by step.
- The volume level can be adjusted within 51 steps—"MIN (minimum)," 01 to 49, and "MAX (maximum)."

### To turn off the sounds temporarily

**From the remote control ONLY:**

Press MUTING.



To restore the sound, press MUTING again.

- Pressing VOLUME + or - also restores the sound.

## 6 Activate Surround or DSP Mode

You can enjoy two kinds of surround—Digital Multichannel Surround (Dolby Digital and DTS Digital Surround) and DSP modes.

### Digital Multichannel Surround—Dolby Digital and DTS Digital Surround

Dolby Digital or DTS Digital Surround takes effect only when you enjoy a disc encoded with its signals—the DOLBY DIGITAL or DTS indicator lights up on the display.



Sound signal indicators on the display

#### To activate Dolby Digital or DTS Digital Surround

When a disc encoded with the Dolby Digital or DTS Digital Surround is loaded, the system detects it and starts playing the disc automatically with Multichannel Surround activated.

- For in-depth information about surround modes, see “Creating Realistic Sound Fields” on pages 18 and 21.

### DSP modes—THEATER, HALL, LIVE CLUB, DANCE CLUB

DSP modes take effect only when you enjoy a disc recorded using Linear PCM—the LINEAR PCM indicator lights up on the display.



Sound signal indicators on the display

#### To activate DSP modes

Press **DSP MODE** (or **DSP** on the front panel).

The DSP indicator lights up and the current DSP mode appears on the display for a while.



- Each time you press the button, DSP mode changes as follows:

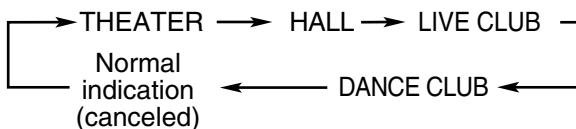

- For in-depth information about DSP modes, see “Creating Realistic Sound Fields” on pages 19, 23, and 24.

#### Note:

Before activating the Surround or DSP mode, adjust the speaker setting to bring out the best performance from this system.

For in-depth information about adjusting the speaker setting, see “Speaker Settings” on pages 16 and 17.

## 7 Stop Playback

Press **■** twice.

Playback stops completely and “DVD” appears on the display. (The DVD player goes on working for 3 minutes after playback stops.)

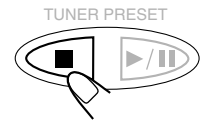

- This system can memorize the end point even when you press **■** once. When you start playback again by pressing **▶/II**, playback begins from where it has been stopped—Resume play.

#### To remove the loaded disc

Press **▲**.

“OPEN” appears on the display and the disc tray comes out.



To close the disc tray, press **▲** again.

- If you do not press the button, the disc tray closes automatically after 3 minutes.

#### To turn off the power (into standby)

Press **STANDBY/ON** **⏻/I** **AUDIO** (or **STANDBY/ON** **⏻/I** on the front panel).



The illumination lamp goes off and the STANDBY lamp lights up.

- If you press **STANDBY/ON** **⏻/I** **AUDIO** (or **STANDBY/ON** **⏻/I** on the front panel) while the disc tray is kept open, the disc tray closes automatically, then the system is turned off.
- A small amount of power is consumed even in standby mode. To turn the power off completely, unplug the AC power cord.

# Basic VCD/CD Operations

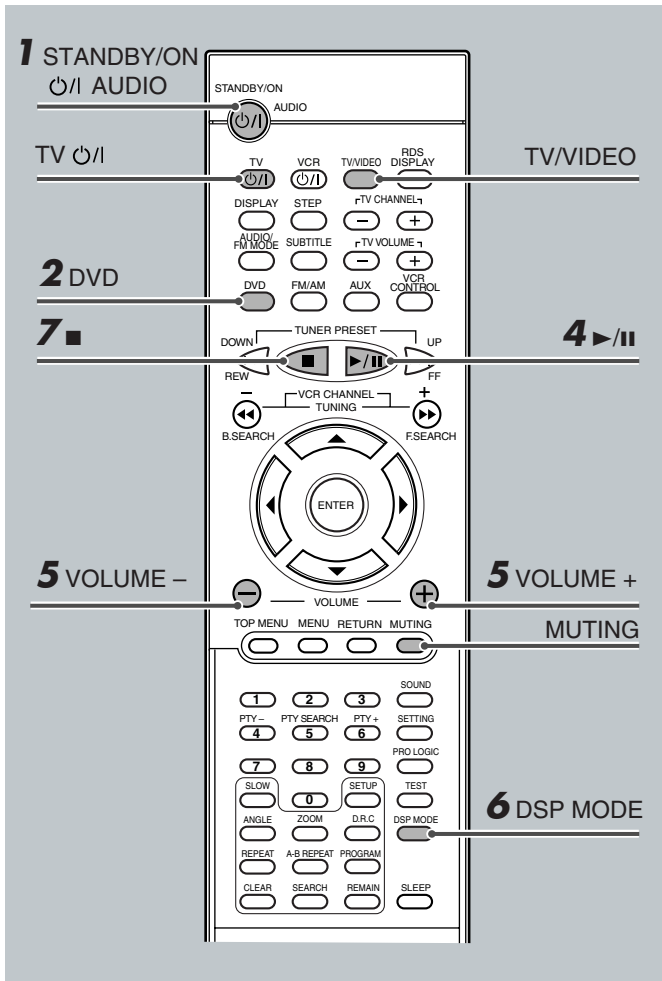

- SVCD can be operated by using the VCD operation procedure.
- For in-depth information about VCD/CD operations, see pages 25, 26, and 34 to 39.

## 1 Turn On the Power

Before turning on the system, turn on your TV if necessary and select the correct video input. (See the manual supplied with your TV.)

- When you use a JVC's TV, you can turn on your TV by pressing TV  $\odot/\text{I}$  on the remote control, and select the video input by pressing TV/VIDEO. (If your TV is not a JVC's, see "Operating Other Manufacturers' TV" on page 55.)
- For changing the OSD messages—the information on the TV screen—into the desired language, see "Setting the Initial Languages" on pages 50 and 51.

Press STANDBY/ON  $\odot/\text{I}$  AUDIO (or STANDBY/ON  $\odot/\text{I}$  on the front panel).

The STANDBY lamp goes off and the illumination lamp on the center unit lights up. The source indication selected previously appears on the display.



## 2 Select the Source

Press DVD.



## 3 Load a VCD/CD

On the front panel ONLY:

Press  $\blacktriangle$  to open the disc tray, then place a disc correctly with its label side up.

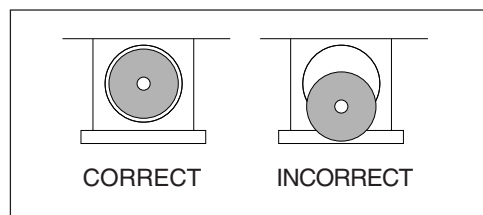

- When using a CD single (8 cm), place it on the inner circle of the disc tray.
- Continued use of irregular shape CDs (heart-shape, octagonal, etc.) can damage the center unit.

## 4 Start Playback

Press  $\blacktriangleright/\text{II}$ .

The disc tray closes. "LOADING" appears for a while.

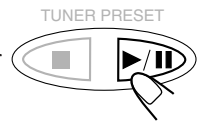

- You can also start playback by closing the disc tray using  $\blacktriangle$  on the front panel.

## 5 Adjust the Volume

To increase the volume, press and hold VOLUME +.  
To decrease the volume, press and hold VOLUME -.



### CAUTION:

Always set the volume to the minimum before starting any source. If the volume is set at its high level, the sudden blast of sound energy can permanently damage your hearing and/or ruin your speakers.

### Notes:

- By pressing VOLUME + or - repeatedly, you can adjust the volume level step by step.
- The volume level can be adjusted within 51 steps—"MIN (minimum)," 01 to 49, and "MAX (maximum)."



## To turn off the sounds temporarily

### From the remote control ONLY:

Press **MUTING**.

To restore the sound, press **MUTING** again.

- Pressing **VOLUME +** or **-** also restores the sound.



## 6 Activate DSP Mode

You can enjoy DSP modes.

### DSP modes—THEATER, HALL, LIVE CLUB, DANCE CLUB

DSP modes take effect only when you enjoy a disc recorded using Linear PCM—the **LINEAR PCM** indicator lights up on the display.



Sound signal indicators on the display

### To activate DSP modes

Press **DSP MODE** (or **DSP** on the front panel).

The DSP indicator lights up and the current DSP mode appears on the display for a while.

- Each time you press the button, DSP mode changes as follows:

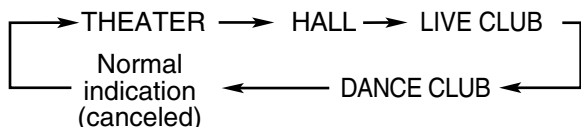

– For in-depth information about DSP modes, see “Creating Realistic Sound Fields” on pages 19, 23, and 24.

### Note:

Before activating the DSP mode, adjust the speaker setting to bring out the best performance from this system.

For in-depth information about adjusting the speaker setting, see “Speaker Settings” on pages 16 and 17.

## 7 Stop Playback

Press **■** twice.

Playback stops completely and “VCD” or “CD” appears on the display. (The DVD player goes on working for 3 minutes after playback stops.)

- This system can memorize the end point even when you press **■** once. When you start playback again by pressing **▶/II**, playback begins from where it has been stopped—Resume play.

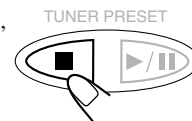

### To remove the loaded disc

Press **▲**.

“OPEN” appears on the display and the disc tray comes out.



To close the disc tray, press **▲** again.

- If you do not press the button, the disc tray closes automatically after 3 minutes.

### To turn off the power (into standby)

Press **STANDBY/ON** **⏻/II** **AUDIO** (or **STANDBY/ON** **⏻/II** on the front panel).

The illumination lamp goes off and the **STANDBY** lamp lights up.

- If you press **STANDBY/ON** **⏻/II** **AUDIO** (or **STANDBY/ON** **⏻/II** on the front panel) while the disc tray is kept open, the disc tray closes automatically, then the system is turned off.
- A small amount of power is consumed even in standby mode. To turn the power off completely, unplug the AC power cord.



# Basic Tuner Operations

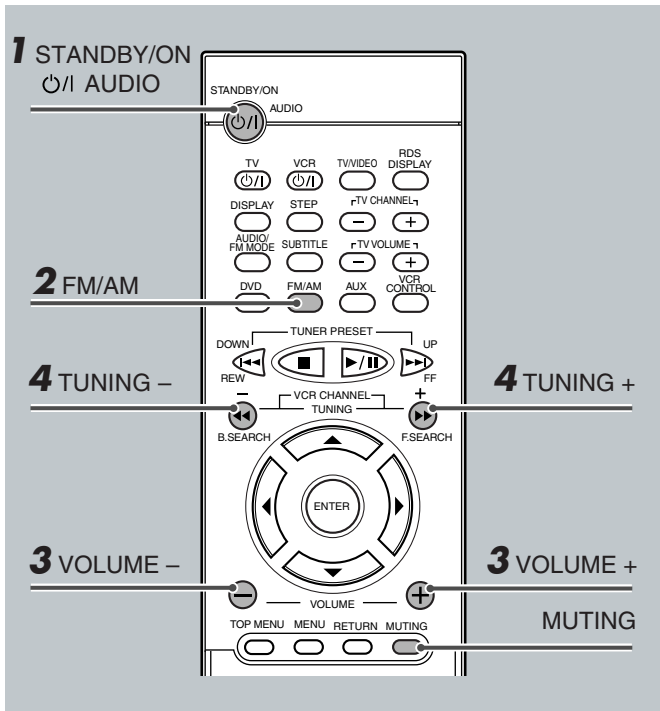

For in-depth information about tuner operations, see “Tuner Operations” on pages 44 to 49.

## 1 Turn On the Power

Press **STANDBY/ON** **AUDIO** (or **STANDBY/ON** on the front panel). The STANDBY lamp goes off and the illumination lamp lights up on the center unit. The source indication selected previously appears on the display.



## 2 Select the Band

**From the remote control:**

Press **FM/AM**. The last received station of the selected band is tuned into.

- Each time you press the button, the band alternates between FM and AM.



**On the front panel:**

Press **SOURCE** repeatedly until the desired band (FM or AM) appears on the display. The last received station of the selected band is tuned into.

- Each time you press the button, the source changes as follows:

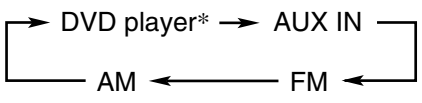

\* “WAIT” appears on the display.

## 3 Adjust the Volume

To increase the volume, press and hold **VOLUME +**. To decrease the volume, press and hold **VOLUME -**.



**CAUTION:**

Always set the volume to the minimum before starting any source. If the volume is set at its high level, the sudden blast of sound energy can permanently damage your hearing and/or ruin your speakers.

**Notes:**

- By pressing **VOLUME +** or **-** repeatedly, you can adjust the volume level step by step.
- The volume level can be adjusted within 51 steps—“MIN (minimum),” 01 to 49, and “MAX (maximum).”
- You can turn off the sounds temporarily by pressing **MUTING**.

## 4 Tune into a Station

**From the remote control:**

Press and hold **TUNING +** or **-** until the station frequency starts changing continuously on the display.

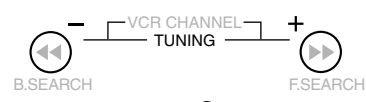

The system starts searching for a station.

**On the front panel:**

- Press **MANUAL** so that “MANUAL” appears on the display.
  - Press and hold **TUNING +** or **-** until the station frequency starts changing continuously on the display.
- The system starts searching for a station.

**Notes:**

- When a station of sufficient signal strength is tuned in, the system stops searching, and the **TUNED** indicator lights up on the display.
- When an FM stereo program is received, the **ST** indicator also lights up.
- When you press the button repeatedly, the frequency changes step by step.

### To turn off the power (into standby)

Press **STANDBY/ON** **AUDIO** (or **STANDBY/ON** on the front panel) again. The illumination lamp goes off and the STANDBY lamp lights up.



A small amount of power is consumed even in standby mode. To turn the power off completely, unplug the AC power cord.

# Other Basic Operations

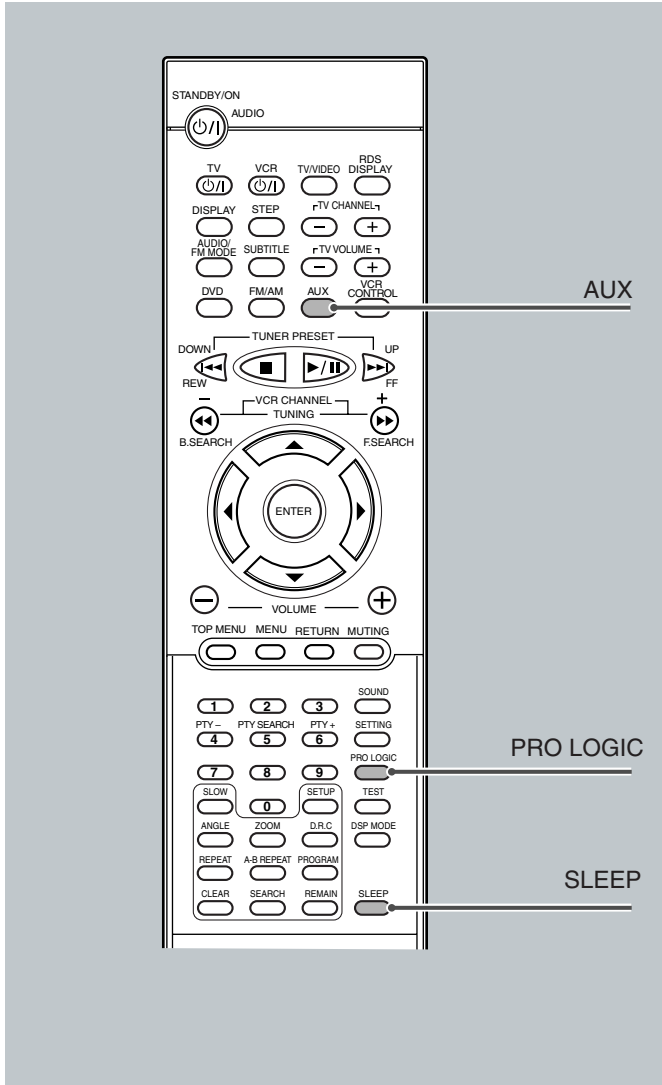

## 2 Start playback on the external component.

- For in-depth information about the external component, see the manual supplied for it.

## 3 Press PRO LOGIC to activate Dolby Surround.



- Each time you press the button, Dolby Surround mode changes as follows:

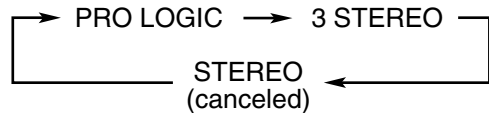

- When Dolby Surround activates, the PRO LOGIC indicator lights up on the display.

– For in-depth information about Pro Logic modes, see “Creating Realistic Sound Fields” on pages 18 and 22.

## Turning Off the Power with the Timer

You can fall asleep while listening to music—Sleep Timer.

### From the remote control ONLY:

#### Press SLEEP.



- Each time you press the button, the shut-off time changes as follows:

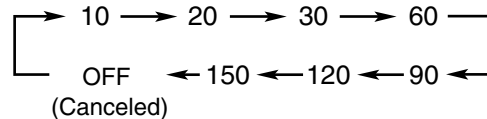

When the shut-off time comes, the system turns off automatically.

## Enjoying Sounds from the External Component

You can enjoy sounds from the external component connected to the AUX IN jacks on the rear panel of the center unit.

- When you listen to sounds encoded with Dolby Surround, you can enjoy Dolby Surround.

### 1 Select AUX as the source.

#### From the remote control:

Press AUX.



#### On the front panel:

Press SOURCE repeatedly until “AUX IN” appears on the display.

- Each time you press the button, the source changes as follows:

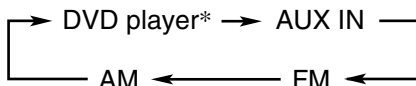

\* “WAIT” appears on the display.



### To check or change the time remaining until the shut-off time

#### Press SLEEP once.

The remaining time (in minutes) appears on the display.

- By pressing SLEEP, you can change the shut-off time.



### To cancel the Sleep Timer

Press SLEEP repeatedly until “OFF” appears on the display.

- Turning off the power also cancels the Sleep Timer.



# Speaker Settings

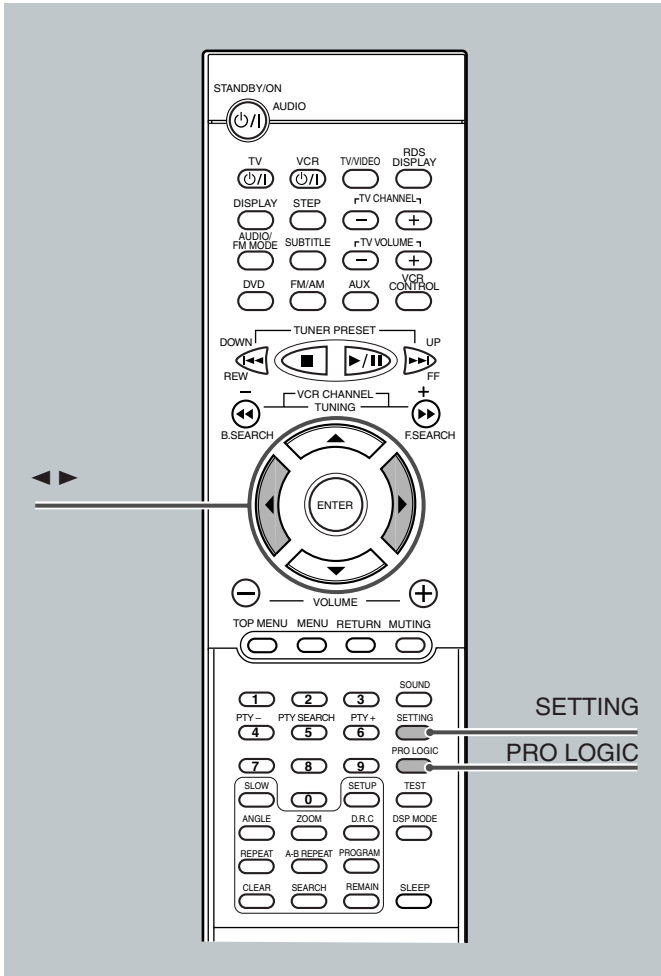

## Setting the Delay Time

Adjust the delay time of the sounds from the center speaker and the rear speakers, comparing to that of the sounds from the front speakers. If the distance to the center speaker\* and/or the rear speakers\*\* from your listening point is almost the same as from the front speakers, select "00 MS (msec)."

- \* You can adjust the delay time only when the DOLBY DIGITAL or DTS indicator is lit on the display.
- \*\* You can adjust the delay time only when the DOLBY DIGITAL, DTS, or PRO LOGIC indicator is lit on the display.

### For Dolby Digital or DTS Digital Surround:

Before you start, remember...

There is a time limit in doing the following steps. If the setting is canceled before you finish, start from step 1 again.

**1** Select and play a DVD encoded with Dolby Digital or DTS Digital Surround.

**2** Press **SETTING** repeatedly until one of delay time indications (with the current setting\*) appears on the display.

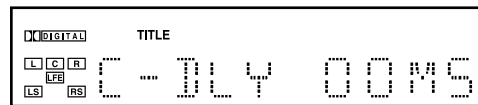

- Each time you press the button, the indication in the main display changes as follows:

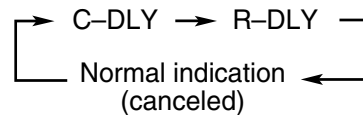

**C-DLY** (Center delay) : To register delay time for center speaker—from 0 msec to 5 msec

**R-DLY** (Rear delay) : To register delay time for rear speakers—from 0 msec to 15 msec

\* The initial setting for the center speaker is "00 MS." The initial setting for the rear speakers is "00 MS." If you have already changed the setting, a different value will be shown.

**3** Press **▶** or **◀** to adjust delay time.

- **▶** : Increases delay time.
- **◀** : Decreases delay time.
- 1 msec increase (or decrease) in delay time corresponds to 30 cm increase (or decrease) in distance.

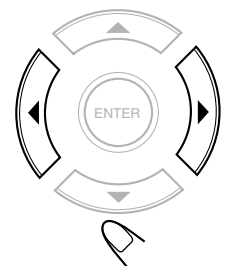

**4** Repeat steps 2 and 3 to adjust the other delay time.

**For Dolby Pro Logic:**

**Before you start, remember...**

There is a time limit in doing the following steps. If the setting is canceled before you finish, start from step 1 again.

**1 Press AUX to select the external component as the source.**



**2 Start playing a source encoded with Dolby Surround.**

**3 Press PRO LOGIC repeatedly on the remote control to select Dolby Pro Logic.**



**4 Press SETTING repeatedly until one of delay time indications (with the current setting\*) appears on the display.**

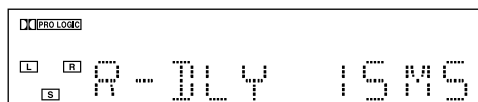

- Each time you press the button, the indication in the main display changes as follows:

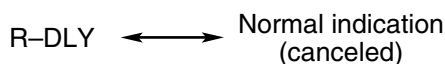

**R-DLY (Rear delay)** : To register delay time for rear speakers—from 15 msec to 30 msec.

\* The initial setting for the rear speakers is “15 MS.”  
If you have already changed the setting, a different value will be shown.

**5 Press ► or ◀ to adjust delay time.**

- ► : Increases delay time.
- ◀ : Decreases delay time.
- 1 msec increase (or decrease) in delay time corresponds to 30 cm increase (or decrease) in distance.

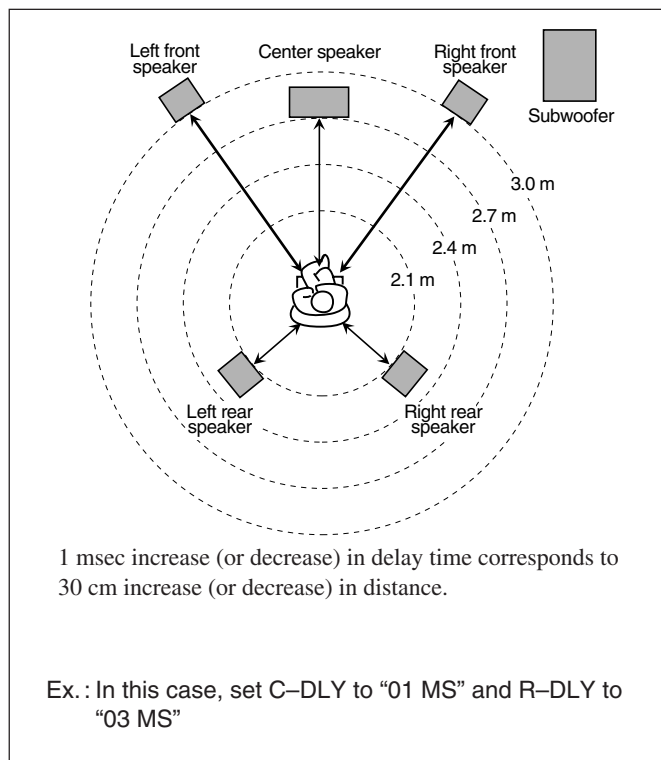
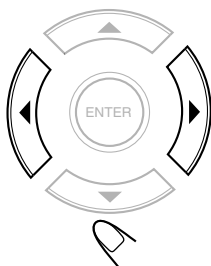

# Creating Realistic Sound Fields

You can use the following surround to reproduce a realistic sound field.

- Digital Multichannel Surround—Dolby Digital and DTS Digital Surround
- Dolby Surround
- DSP (Digital Signal Processor) modes

## ■ Dolby Digital and DTS Digital Surround

To enjoy surround effectively, all the speakers need to be connected and activated.

### Dolby Digital\*

Used to reproduce multichannel sound tracks of the software encoded with Dolby Digital (  ).

**Dolby Digital** encoding method (so-called discrete 5.1 channel digital audio format) records and digitally compresses the left front channel, right front channel, center channel, left rear channel, right rear channel, and LFE channel signals (total 6 channels, but LFE channel is counted as 0.1 channel. Therefore, called 5.1 channel). Since each channel is completely independent from the other channel signals to avoid interference, you can obtain much better sound quality with much stereo and surround effects. In addition, Dolby Digital enables stereo rear sounds, and sets the cutoff frequency of the rear treble at 20 kHz, compared to 7 kHz for Dolby Pro Logic. These facts enhance the sound movement and being-there feelings much more than Dolby Pro Logic.

When the system detects Dolby Digital signals, the DOLBY DIGITAL indicator lights up on the display.

### DTS Digital Surround\*\*

Used to reproduce multichannel sound tracks of the software encoded with DTS Digital Surround (  ).

**DTS Digital Surround** is another discrete 5.1 channel digital audio format available on CD, LD, and DVD software. Compared to Dolby Digital, audio compression rate is relatively low. This fact allows DTS Digital Surround format to add breadth and depth to the reproduced sounds. As a result, DTS Digital Surround features natural, solid and clear sound.

When the system detects DTS Digital Surround signals, the DTS indicator lights up on the display.

## ■ Dolby Surround\*

Used to reproduce sound tracks of the VCR tapes encoded with Dolby Surround (  ).

This is only used for the sound sources coming through the AUX IN jacks.

## Dolby Pro Logic and Dolby 3 Stereo

**Dolby Surround** encoding format records the left front channel, right front channel, center channel, and rear channel signals (total 4 channels) into 2 channels.

The **Dolby Pro Logic** decoder built in this system decodes these 2 channel signals into original 4 channel signals—matrix-based multichannel reproduction, and allows you to enjoy a realistic stereo sound in your listening room.

When one of Dolby Surround is selected, the PRO LOGIC indicator lights up on the display.

### Indications on the display for each surround

#### • Dolby Digital

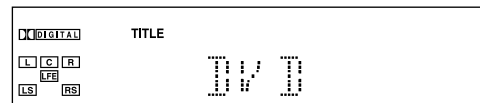

#### • DTS Digital Surround

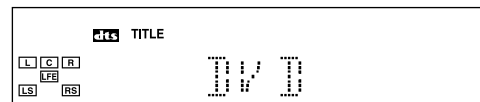

#### • Dolby Pro Logic

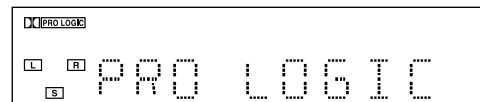

#### • Dolby 3 Stereo

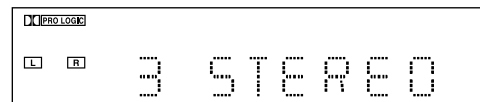

#### • DSP\*

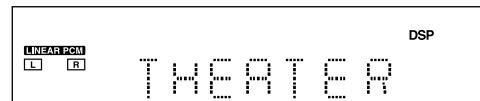

- \* When you select FM/AM or AUX as the source, the Linear PCM indicator (  ) does not light up.
- According to the speaker settings, some speaker indicators do not light up. In this case, set the speaker setting appropriately.

\* Manufactured under license from Dolby Laboratories. "Dolby," "Pro Logic," and the double-D symbol are trademarks of Dolby Laboratories. Confidential Unpublished Works. ©1992–1997 Dolby Laboratories. All rights reserved.

\*\* Manufactured under license from Digital Theater Systems, Inc. US Pat. No. 5,451,942 and other world-wide patents issued and pending. "DTS" and "DTS Digital Surround" are trademarks of Digital Theater Systems, Inc. ©1996 Digital Theater Systems, Inc. All rights reserved.

## ■ DSP (Digital Signal Processor) Modes

DSP modes have been designed to create important acoustic surround elements.

The sound heard in a theater, a hall, a live club, or a dance club consists of direct sound and indirect sound—early reflections and reflections from behind. Direct sounds reach the listener directly without any reflection. On the other hand, indirect sounds are delayed by the distances of the ceiling and walls.

These indirect sounds are important elements of the acoustic surround effects.

The following DSP modes are provided with this unit.

<b>THEATER</b>	: Gives the feeling of a theater.
<b>HALL</b>	: Gives clear vocal and the feeling of a concert hall.
<b>LIVE CLUB</b>	: Gives the feeling of a live music club with a low ceiling.
<b>DANCE CLUB</b>	: Gives a throbbing bass beat.

These DSP modes can be used to add the acoustic surround effects while reproducing stereo analog software or Linear PCM digital software, and can give you a real “being there” feeling.

When one of the DSP modes is selected, the DSP indicator lights up on the display.

### To check the speaker connections and settings using the test tone

1. Select and play a DVD encoded with Dolby Digital or DTS Digital Surround.
2. Press TEST on the remote control.  
The test tone comes out from the speakers (except subwoofer) in the order.
  - If there is a speaker from which no sounds comes out, check the speaker’s connection (see pages 6 and 7.)
3. Press TEST again to stop the test tone.



### Available surround according to the input signal format

○: Possible    ×: Impossible

Surround	Multichannel Surround	Pro Logic*		DSP				(canceled)
		Pro Logic	3 Stereo	THEATER	HALL	LIVE CLUB	DANCE CLUB	STEREO
Input Signal format	Analog	×	○	○	○	○	○	○
	Linear PCM	×	○	○	○	○	○	○
	Dolby Digital Multichannel	○	×	×	×	×	×	×
	Dolby Surround	×	○	○	○	○	○	○
	DTS Digital Surround	○	×	×	×	×	×	×

\* You can use Pro Logic mode for all 2 channel sources, but surround effect does not work sufficiently except Dolby Surround encoded source.

# Creating Realistic Sound Fields

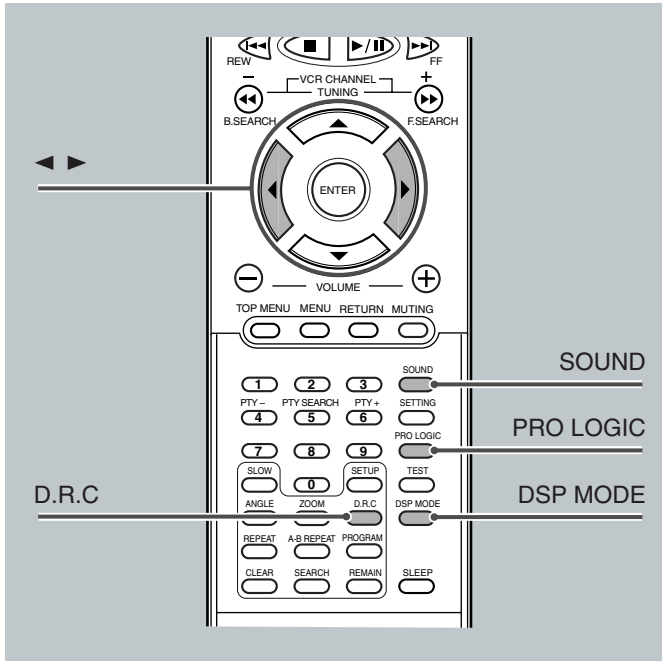

## Adjusting Stereo Sound

You can adjust the following settings.

It is recommended that you make adjustments from your actual listening point while listening to reproduced sounds.

- Output balance for the front speakers
- Output level for the subwoofer

Once you adjust these items, the adjustments take effect for all the surround modes.

### Before you start, remember...

- There is a time limit in doing the following steps. If the setting is canceled before you finish, start from step **2** again.

**1** Select and play any source except Dolby Digital or DTS Digital Surround.

**2** Cancel Dolby Surround or DSP modes if they are activated.

For deactivating Dolby Surround:

Press **PRO LOGIC** on the remote control until “STEREO” appears on the display.

PRO LOGIC



For deactivating DSP modes:

Press **DSP MODE** (or **DSP** on the front panel) until the DSP indicator goes off from the display.

DSP MODE



Now, you are ready to start adjustments.

- To adjust the output balance for the front speakers, go to the next step.
- To adjust the output level for the subwoofer, go to step **4**.

**3** To adjust the output balance for the front speakers

1) Press **SOUND** repeatedly until the adjustment indication for the front speakers appears on the display.



- Each time you press the button, the adjustment indication on the display changes as follows:

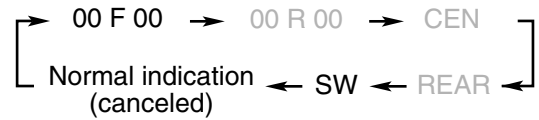

2) Press **▶** or **◀** to adjust the output balance.

- ▶ : Decreases the left speaker output, or restores the right speaker output.
- ◀ : Decreases the right speaker output, or restores the left speaker output.

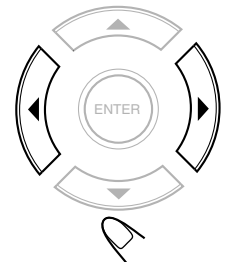

- The output balance changes from OFF (silence), –06 (most reduction) to 00 (no reduction).
- “00 F 00” is the initial setting (the output balance is at the center position). If you have already changed the setting, another value will appear.

**4** To adjust the output level for the subwoofer

1) Press **SOUND** repeatedly to select “SW.”



- Each time you press the button, the adjustment indication on the display changes as follows:

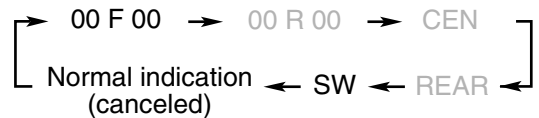

2) Press **▶** or **◀** to adjust the output level.

- ▶ : Increases the output level.
- ◀ : Decreases the output level.
- The output level changes from –6 to +6.
- “SW 0dB” is the initial setting. If you have already changed the settings, another value will appear.

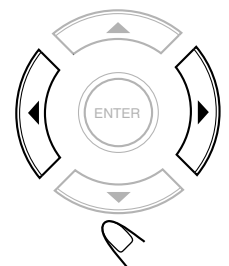



## Adjusting Dolby Digital and DTS Digital Surround

You can adjust the following settings while activating Dolby Digital or DTS Digital Surround.

It is recommended that you make adjustments from your actual listening point while listening to reproduced sounds.

- Output balance for the front speakers
- Output balance for the rear speakers
- Output level for the center speaker
- Output level for the rear speakers\*
- Output level for the subwoofer

\* The adjustment is separately memorized for Digital Multichannel Surround (Dolby Digital and DTS Digital Surround), and for Dolby Pro Logic.

**Before you start, remember...**

- There is a time limit in doing the following steps. If the setting is canceled before you finish, start from step **2** again.

### 1 Select and play a DVD encoded with Dolby Digital or DTS Digital Surround.

Now, you are ready to start adjustments.

- To adjust the output balance for the front speakers and the rear speakers, go to the next step.
- To adjust the output level for the center speaker, the rear speakers, and the subwoofer, go to step **3**.

### 2 To adjust the output balance for the front speakers and the rear speakers

#### 1) Press SOUND repeatedly until one of the following adjustment indications appears on the display.



- Each time you press the button, the adjustment indication on the display changes as follows:

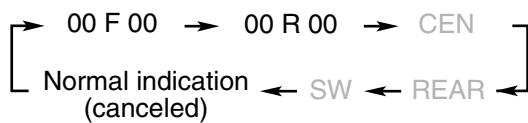

**00 F (Front) 00** : To adjust the output balance for the front speakers.

**00 R (Rear) 00** : To adjust the output balance for the rear speakers.

- “00 F 00” and “00 R 00” are the initial setting (the output balances are at the center position). If you have already changed the setting, another value will appear.

#### 2) Press ► or ◀ to adjust the output balance.

- : Decreases the left speaker output, or restores the right speaker output.
- ◀ : Decreases the right speaker output, or restores the left speaker output.

- Each output balance changes from OFF (silence), -06 (most reduction) to 00 (no reduction).

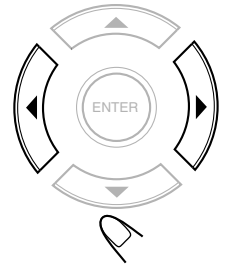

#### 3) Repeat 1) and 2) for setting the other speaker.

### 3 To adjust the output levels for the center speaker, the rear speakers, and the subwoofer

#### 1) Press SOUND repeatedly to select the “CEN,” “REAR,” or “SW.”



- Each time you press the button, the adjustment indication on the display changes as follows:

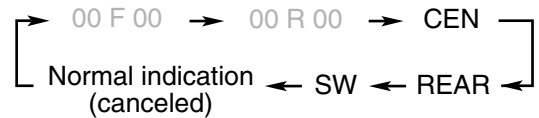

**CEN (Center)** : To adjust the output level for center speaker (from -6 dB to +6 dB).

**REAR** : To adjust the output level for rear speakers (from -6 dB to +6 dB).

**SW (Subwoofer)** : To adjust the output level for subwoofer (from -6 dB to +6 dB).

- “CEN 0dB,” “REAR 0dB,” and “SW 0dB” are the initial settings. If you have already changed the settings, another value will appear.

#### 2) Press ► or ◀ to adjust the output level.

- : Increases the output level.
- ◀ : Decreases the output level.

#### 3) Repeat 1) and 2) for setting the other speakers.

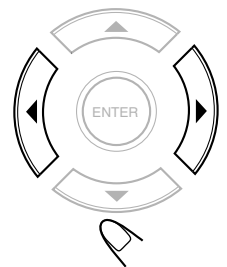

## Activating Dynamic Range Compression

You can enjoy a powerful sound even at a low volume level by compressing the dynamic range (difference between the maximum and minimum sounds).

- This function takes effect only when Dolby Digital is activated.

**From the remote control ONLY:**

**Press D.R.C.**

- Each time you press the button, the dynamic range compression mode alternates between on and off. Select “DRC ON” while watching the DVD at night. (You can obtain a powerful sound at a low volume.)



# Creating Realistic Sound Fields

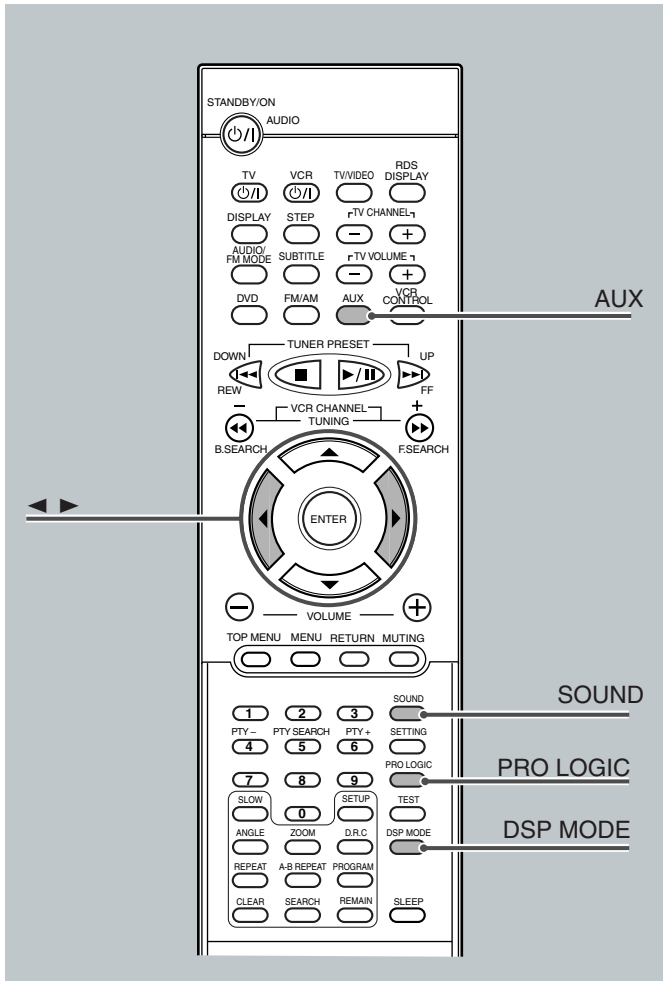

### 3 Press PRO LOGIC repeatedly on the remote control to select Dolby Pro Logic or Dolby 3 Stereo.



The PRO LOGIC indicator lights up on the display.

- Each time you press the button, the indication changes as follows:

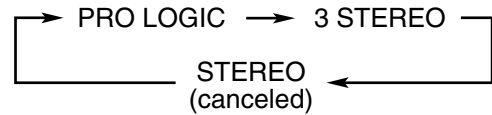

Now, you are ready to start adjustments.

- To adjust the output balance for the front speakers and the rear speakers, go to the next step.
- To adjust the output level for the center speaker, the rear speakers, and the subwoofer, go to step 5.

### 4 To adjust the output balance for the front speakers and the rear speakers

#### 1) Press SOUND repeatedly until one of the following adjustment indications appears on the display.



- Each time you press the button, the adjustment indication on the display changes as follows:

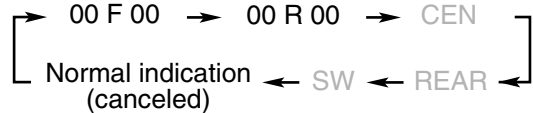

**00 F (Front) 00** : To adjust the output balance for the front speakers.

**00 R (Rear) 00** : To adjust the output balance for the rear speakers.

- When selecting “3 STEREO,” you cannot adjust the output balance for the rear speakers.
- “00 F 00” and “00 R 00” are the initial settings (the output balances are at the center position). If you have already changed the setting, another value will appear.

#### 2) Press ► or ◀ to adjust the output balance.

- : Decreases the left speaker output, or restores the right speaker output.

- ◀ : Decreases the right speaker output, or restores the left speaker output.

- Each output balance changes from OFF (silence), -06 (most reduction) to 00 (no reduction).

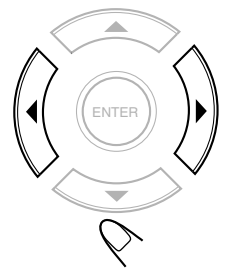

#### 3) Repeat 1) and 2) for setting the other speakers.

## Adjusting Dolby Surround

You can adjust the following settings while activating Dolby Surround.

It is recommended that you make adjustments from your actual listening point while listening to reproduced sounds.

- Output balance for the front speakers
- Output balance for the rear speakers
- Output level for the rear speakers\*
- Output level for the subwoofer

- When Dolby 3 Stereo is activated, you cannot adjust the rear speakers.
- \* The adjustment is separately memorized for Digital Multichannel Surround (Dolby Digital and DTS Digital Surround), and for Dolby Pro Logic.
- Dolby Surround cannot be used with DSP modes. Once one of Dolby Surround is activated, DSP modes in use will be canceled.

Before you start, remember...

- There is a time limit in doing the following steps. If the setting is canceled before you finish, start from step 3 again.

### 1 Press AUX to select the external component as the source.



### 2 Start playing a source encoded with Dolby Surround.

## 5 To adjust the output level for the center speaker, the rear speakers, and the subwoofer.

### 1) Press **SOUND** repeatedly to select the “CEN,” “REAR,” or “SW.”



- Each time you press the button, the indication on the display changes as follows:

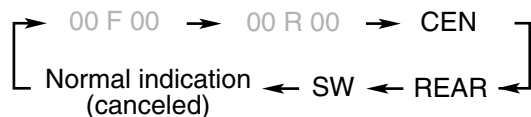

**CEN** (Center) : To adjust the output level for center speaker (from -6 dB to +6 dB).

**REAR** : To adjust the output level for rear speakers (from -6 dB to +6 dB).

**SW** (Subwoofer) : To adjust the output level for subwoofer (from -6 dB to +6 dB).

- When selecting “3 STEREO,” you cannot adjust the output levels for the rear speakers.
- “CEN 0dB,” “REAR 0dB,” and “SW 0dB” are the initial settings. If you have already changed the settings, another value will appear.

### 2) Press **▶** or **◀** to adjust the output level.

- ▶ : Increases the output level.
- ◀ : Decreases the output level.

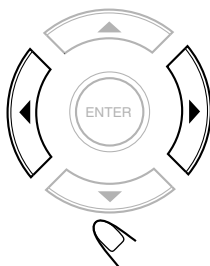

### 3) Repeat 1) and 2) for setting the other speakers.

## Adjusting DSP Modes

You can adjust the following settings while activating DSP modes. It is recommended that you make adjustments from your actual listening point while listening to reproduced sounds.

- Output balance for the front speakers
- Output balance for the rear speakers
- Output level for the rear speakers
- Output level for the subwoofer

- DSP modes cannot be used with Dolby Surround. Once one of DSP modes is activated, Dolby Surround in use will be canceled.
- When you play back a DVD encoded with Dolby Digital or DTS Digital Surround, DSP MODE button (or DSP button on the center unit) does not work.

### Before you start, remember...

- There is a time limit in doing the following steps. If the setting is canceled before you finish, start from step **2** again.

## 1 Select and play any source except Dolby Digital or DTS Digital Surround.

## 2 Press **DSP MODE** (or **DSP** on the front panel) repeatedly to select the desired DSP mode.



The DSP indicator lights up on the display while the DSP modes are activated.

- Each time you press the button, DSP mode changes as follows:

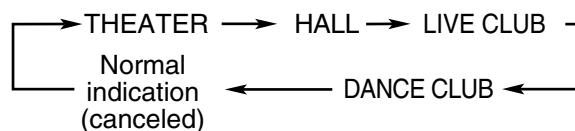

### Now, you are ready to start the adjustment.

- To adjust the output balance for the front speakers and the rear speakers, go to the next step.
- To adjust the output level for the rear speakers and the subwoofer, go to step **4** on the next page.

# Creating Realistic Sound Fields

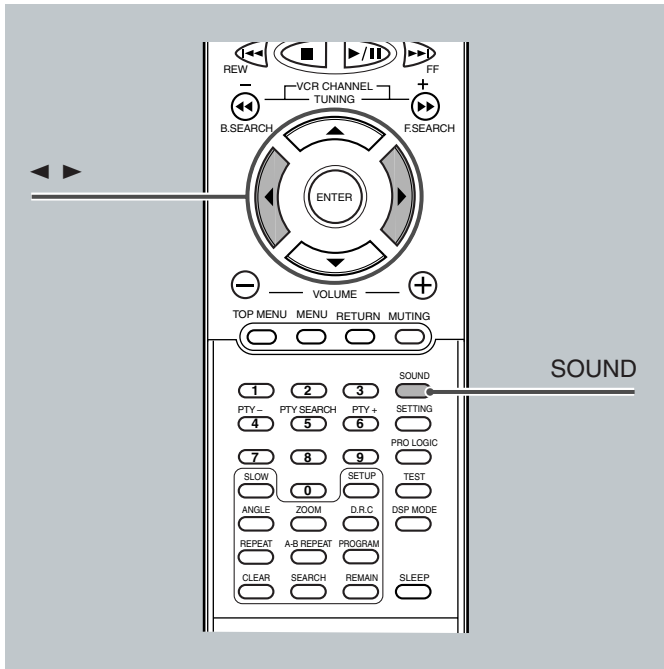

### 3 To adjust the output balance for the front speakers and the rear speakers

#### 1) Press **SOUND** repeatedly until one of the following adjustment indications appears on the display.



- Each time you press the button, the adjustment indication on the display changes as follows:

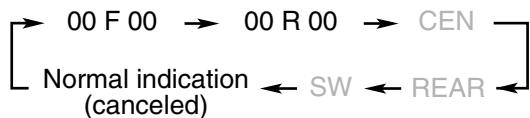

**00 F (Front) 00** : To adjust the output balance for the front speakers.

**00 R (Rear) 00** : To adjust the output balance for the rear speakers.

- “00 F 00” and “00 R 00” are the initial setting (the output balances are at the center position). If you have already changed the setting, another value will appear.

#### 2) Press **▶** or **◀** to adjust the output balance.

- ▶ : Decreases the left speaker output, or restores the right speaker output.
- ◀ : Decreases the right speaker output, or restores the left speaker output.

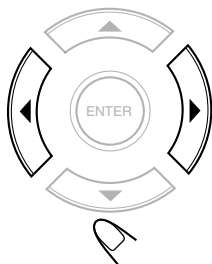

- Each output balance changes from OFF (silence), -06 (most reduction) to 00 (no reduction).

#### 3) Repeat 1) and 2) for setting the other speaker.

### 4 To adjust the output level for the rear speakers and the subwoofer.

#### 1) Press **SOUND** repeatedly to select the “REAR” or “SW:”



- Each time you press the button, the adjustment indication on the display changes as follows:

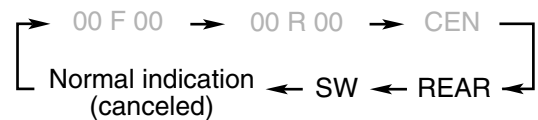

**REAR** : To adjust the output level for rear speakers (from -6 dB to +6 dB).

**SW (Subwoofer)** : To adjust the output level for subwoofer (from -6 dB to +6 dB).

- “REAR 0dB” and “SW 0dB” are the initial setting. If you have already changed the setting, another value will appear.

#### 2) Press **▶** or **◀** to adjust the output level.

- ▶ : Increases the output level.
- ◀ : Decreases the output level.

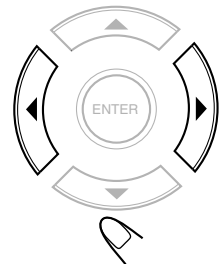

#### 3) Repeat 1) and 2) for setting the other speakers.

# Disc Introduction—DVD/VCD/CD

This system has been designed to play back the following discs: DVD, Video CD, Super Video CD (SVCD), Audio CD, CD-R, and CD-RW.

- This system can also play back MP3 files recorded on CD-Rs and CD-RWs. For in-depth information about what MP3 is, see “MP3 Introduction” on page 40.

## Discs you can play:

Disc Type	Mark (Logo)	Video Format	Region Code Number*
DVD Video		PAL	2 ALL
Video CD		PAL	_____
Super Video CD			_____
Audio CD		_____	_____
CD-R		_____	_____
CD-RW		_____	_____

- On some DVD or VCD/SVCD discs, their actual operations may be different from what is explained in this manual. This is due to the disc programming and disc structure, but not a malfunction of this system.
- The following discs cannot be played back:
  - DVD-Audio, DVD-ROM, DVD-RAM, DVD-R, DVD-RW, CD-ROM, CD-I, (CD-I Ready), Photo CD, etc.
 Playing back these discs will generate noise and damage the speakers.

### \* Note on Region Code

DVD players and DVD Video discs have their own Region Code numbers. This system only can play back DVD discs whose Region Code numbers include “2.”

Examples:



If a DVD with the inadequate Region Code numbers is loaded, “REGION ERR” appears on the display and playback cannot start.

**IMPORTANT:** Before performing any operations, make sure of the following....

- Check the connection with the TV.
- Turn on the TV and select the correct input on the TV to view the pictures or on-screen indications on the TV screen.
- For DVD playback, you can change the Setup menu setting to your preference. (See pages 50 to 53.)

If “⊗” appears on the TV screen when pressing a button, the disc cannot accept an operation you have tried to do, or information required for that operation is not recorded in the disc.

NOTICE : In some cases, without showing “⊗,” operations will not be accepted.

## Disc structure—DVD, Video CD (VCD/SVCD) and Audio CD (CD)

A DVD disc consists of **Titles**, and each title may be divided into some **Chapters**. (See Example 1.)

For example, if a DVD disc contains some movies, each movie may have its own title number, and it may be further divided into some chapters.

On the other hand, a VCD/SVCD or CD consists of **Tracks**. (See Example 2.)

In general, each song has its own track number. (On some discs, each track may also be divided by Indexes.)

When playing back a VCD/SVCD with Playback Control (PBC) function, you can select what to view using the menu shown on the TV screen. (While operating a Video CD using the menu, some of the functions such as Repeat and Track Search may not work.)

Example 1: DVD disc

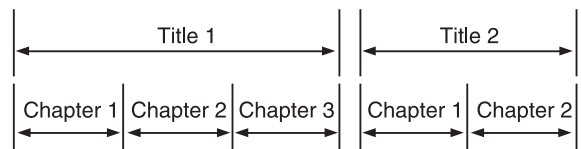

Example 2 : Video CD/Audio CD



### Notes on CD-R and CD-RW

User-edited CD-Rs (Recordable) and CD-RWs (Rewritable) can be played back only if they are already “**finalized**.”

- The system can play back CD-Rs or CD-RWs recorded on a personal computer if they have been recorded in the audio CD format or recorded in MP3 format (see page 40). However, they may not be played back depending on their characteristics or recording conditions.
- Before playing back CD-Rs or CD-RWs, read their instructions or cautions carefully.
- Some CD-Rs or CD-RWs may not be played back on this unit because of their disc characteristics, damage or stain on them, or if the built-in lens is dirty.
- CD-RWs may require a longer readout time. This is caused by the fact that the reflectance of CD-RWs is lower than for regular CDs.

# Basic Disc Operations

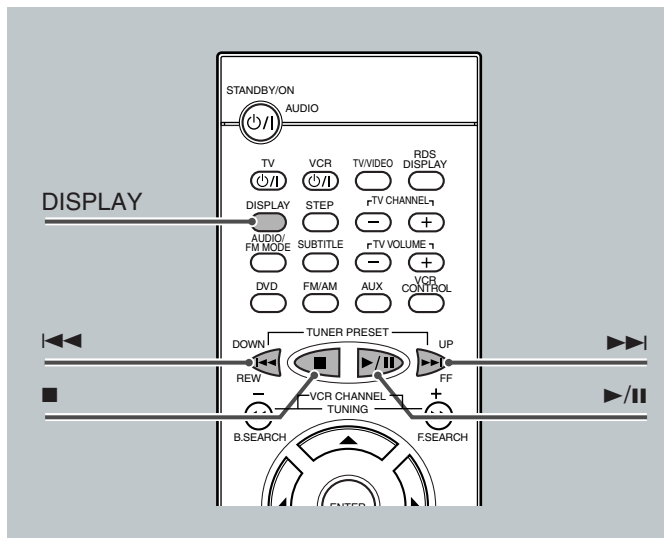

SVCD can be operated by using the VCD operation procedure.

## To start playback

Press ►/II.

The source is automatically changed to the DVD player.

“WAIT” appears on the display for a while, then the detected disc type appears—DVD, VCD, CD, or MP3. (If your TV is turned on, the mark corresponding to the detected disc type appears on the TV screen.)

- When a disc is not loaded, “NO DISC” appears on the display.

Disc play starts from the first chapter or track of the selected disc.

- If a menu appears while playing a DVD or VCD with PBC function, see “Disc Menu-Driven Playback” (for DVD) on page 29 or “Disc Menu-Driven Playback (Only for VCD)” on page 35.

### Note:

If “WRONG PARENTAL CODE” appears on the TV screen, Parental Lock is in use. You cannot play back a DVD containing violent scenes or those not suitable for your family members.

To play back such a disc, cancel the Parental Lock. (See page 53.)

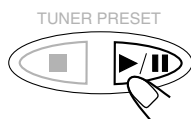

## To stop playback for a moment

Press ►/II.

While pausing, minute and second digit of elapsed playing time flashes on the display.

- To resume play, press ►/II.

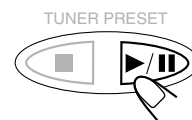

## To go to another chapter or track

Press ►| or |◀ repeatedly during playback.

- ►| : Skips to the beginning of the next or succeeding chapter or track.
- |◀ : While a DVD, a VCD with PBC or MP3 is played back Goes back to the beginning of the previous chapter or track. While a CD or a VCD without PBC is played back Goes back to the beginning of the current or previous track.

## To go to another title (only possible on a DVD) or track (only possible on a CD and VCD) directly using the number buttons

Pressing the number buttons before or during play allows you to start playing the title/track number you want. (If your TV is turned on, the on-screen bar is pulled down automatically on the TV screen.)

- To select number 1 to 9, press the corresponding number button (then press ENTER or wait for 5 seconds).
- To select number 15, press 1, 5.
- To select number 23, press 2, 3.

## To stop during playback

Press ■.

(If your TV is turned on, “■ STOP” appears on the TV screen.)

- When an MP3 disc is played back, playback stops completely.
- This system can memorize the end point even when you press ■. When you start playback again by pressing ►/II, playback begins from where it has been stopped—Resume play.
- To stop completely, press ■ twice. (“■ STOP” appears on the TV screen.) The disc type appears on the display. The DVD player goes on working for 3 minutes after playback stops.

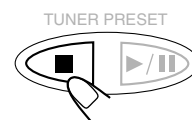

## To remove the disc

Press ▲ on the front panel.

The disc tray comes out.

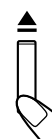

To close the disc tray, press ▲ again.

- If you do not press the button, the disc tray closes automatically 3 minutes after.

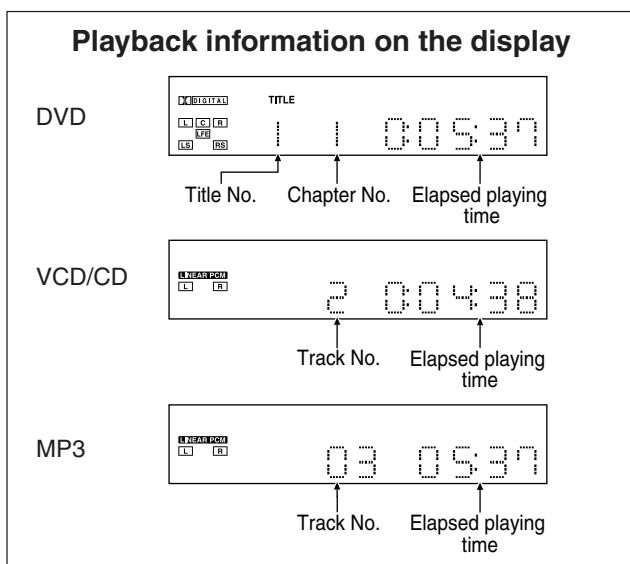

## Playback information on the display



# DVD Playback

Some DVDs contain several audio languages, subtitles, and multi-angle views.

When you find the following marks on the DVD or its package, you can select these elements recorded on the DVD.

	Subtitles are recorded on the disc. The number inside the mark indicates the total number of the recorded subtitles.
	Several audio languages are recorded on the disc. The number inside the mark indicates the total number of the recorded audio languages.
	Multi-angle views are recorded on the disc. The number inside the mark indicates the total number of the recorded multi-angle views.

If you cannot find out whether your disc contains these features listed above, you can check it by showing the on-screen bar.

For basic disc operations such as inserting a disc, starting playback, and moving to another chapters, see “Basic DVD Operations” on pages 10, 11, and “Basic Disc Operations” on page 26.

## Showing the On-Screen Bar

You can show the following information on the TV screen while a disc is loaded.

### From the remote control ONLY:



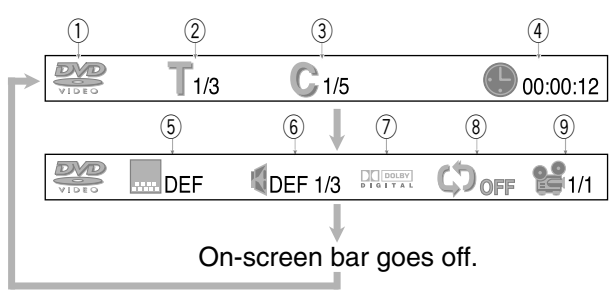

Press **DISPLAY**.

- Each time you press the button, the following on-screen bar appears in sequence.





On-screen bar goes off.

<p>① : Disc type</p> <p>DVD  VCD  SVCD  CD  MP3 </p>
<p>② : Current title and total number of the titles on the disc</p> <ul style="list-style-type: none"> <li>• Ex.: 1st title is playing out of 3 titles recorded.</li> </ul>
<p>③ : Current chapter and total number of the chapters in the current title</p> <ul style="list-style-type: none"> <li>• Ex.: 1st chapter is playing out of 5 chapters recorded.</li> </ul>
<p>④ : Elapsed playing time or remaining time</p> <p>You can change the play time indication by pressing <b>REMAIN</b>. See page 29 for more details.</p>
<p>⑤ : Subtitle language indication</p> <ul style="list-style-type: none"> <li>• Ex.: When no subtitle is recorded on the disc.</li> </ul> <p>See page 28 for more details.</p>
<p>⑥ : Audio language indication</p> <ul style="list-style-type: none"> <li>• Ex.: Original sound (default) is selected out of 3 audio languages recorded. See page 28 for more details.</li> </ul>
<p>⑦ : Signal format indicator</p> <ul style="list-style-type: none"> <li>• Signal format type—Linear PCM (stereo), Dolby Digital, and DTS Digital Surround—will be indicated.</li> </ul> <p>Ex.: When the disc is encoded with Dolby Digital.</p>
<p>⑧ : Repeat mode indicator</p> <ul style="list-style-type: none"> <li>• Ex.: When repeat mode is turned off.</li> </ul> <p>See page 30 for more details.</p>
<p>⑨ : Multi-angle view indicator</p> <ul style="list-style-type: none"> <li>• Ex.: When only a single angle-view is recorded on the disc. See page 28 for more details.</li> </ul>

# DVD Playback

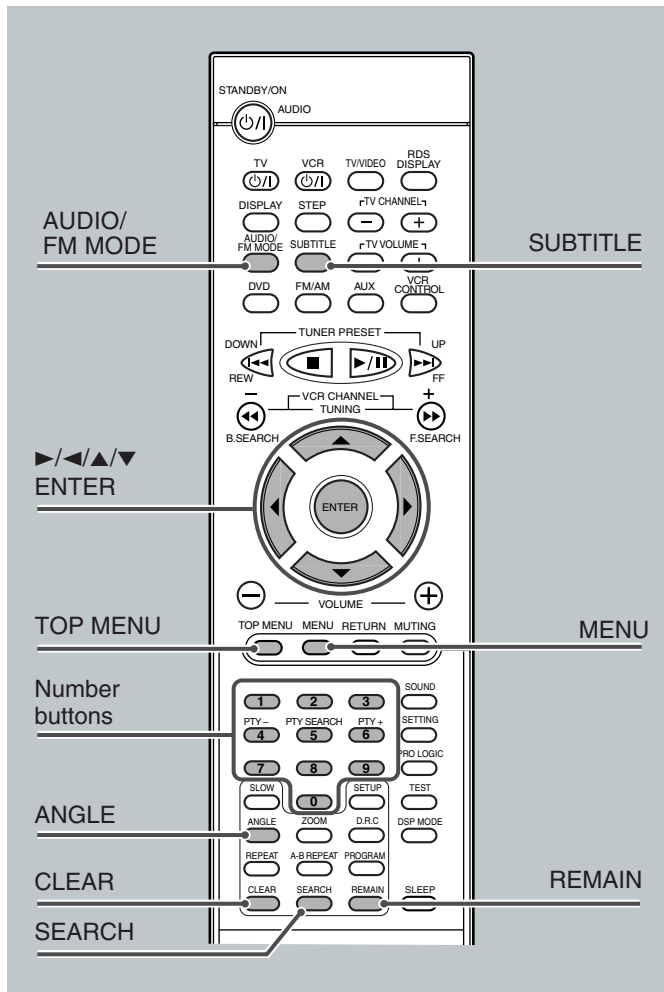

## Selecting the Subtitles

While playing back a DVD containing subtitles in different languages, you can select the subtitle to be displayed on the TV screen.

- You can set your favorite subtitle language as the initial language shown on the screen. (See page 50.)

### From the remote control ONLY:

Press **SUBTITLE**.

The on-screen bar appears on the TV screen for a while.

- Each time you press the button, the subtitle language changes as follows:

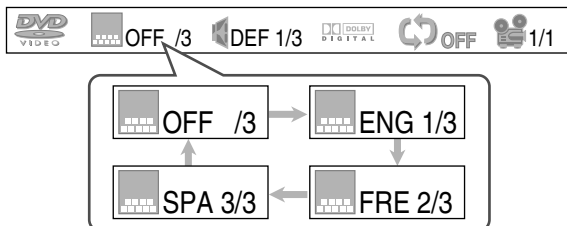

Ex.: When the disc has 3 selections—English, French, Spanish and no subtitle (OFF)

## Selecting the Audio Languages

While playing back a DVD containing audio languages (sound track), you can select the language (sound track) to listen to.

- You can set your favorite audio language as the initial audio language. (See page 50.)

### Press **AUDIO/FM MODE**.

The on-screen bar appears on the TV screen for a while.

- Each time you press the button, the audio language changes as follows:

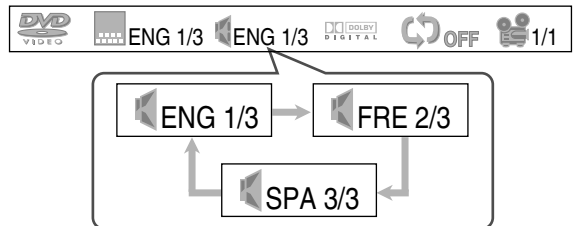

Ex.: When the disc has 3 selections—English, French, and Spanish

## Selecting the Multi-Angle Views

While playing back a DVD containing multi-angle views, you can view the same scene at different angles.

- When you play back the DVD containing multi-angle views, appears on the TV screen.

### From the remote control ONLY:

Press **ANGLE**.

- Each time you press the button, the view angle changes.

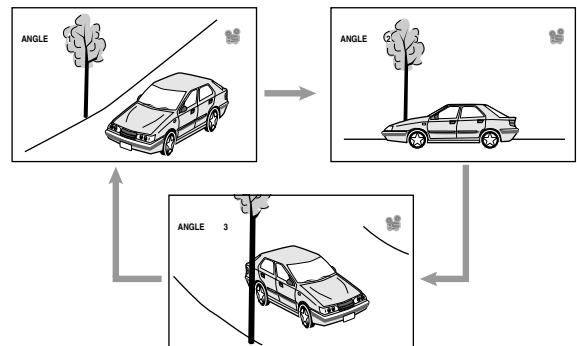

Ex.: When the disc has 3 multi-angle views

### Note:

When the on-screen bar is shown on the TV screen, Multi-angle view indication also changes as follows:

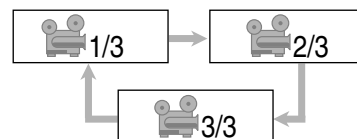



## Checking the Remaining Time

While playing back a DVD, you can check the remaining time to be played back.

### From the remote control ONLY:

Press **REMAIN**.

The on-screen bar and the current play time indication appear on the TV screen for a while.



- Each time you press the button, the following indication appears on the screen:



#### REMAIN TIME:TITLE

: Select this to show the remaining time of the current title.

#### CHAPTER TIME

: Select this to show the elapsed playing time of the current chapter.

#### REMAIN TIME:CHAPTER

: Select this to show the remaining time of the current chapter.

#### TITLE TIME

: Select this to show the elapsed playing time of the current title.

## Disc Menu-Driven Playback

Disc menu-driven playback is possible while playing back a DVD with menu (menu may be still pictures or moving pictures depending on the disc).

- When operating a disc using the disc menu, refer also to the instructions supplied for the disc.

DVD discs generally have their own menus or title lists. A menu usually contains various information about the disc and playback selections. On the other hand, a title list usually contains titles of movies and songs recorded.

### From the remote control ONLY:

#### 1 Press **MENU** or **TOP MENU**.

A menu or title list will appear on the screen. "MENU" appears on the display.

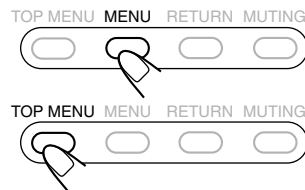

- On some DVDs, a menu will automatically appear on the screen after playback starts.

#### 2 Select a desired item on the menu or on the title list, using **▶/◀/▲/▼** and **ENTER**.

The unit starts playback of the selected item.

- On some discs, you can also select items by pressing the number buttons corresponding to the item numbers listed.

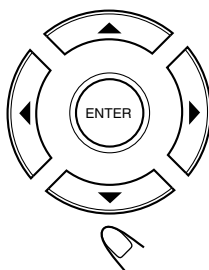

## Moving to a Particular Portion Directly

You can move to another title, chapter, or particular scene in the chapter directly.

### From the remote control ONLY:

#### 1 Press **SEARCH** during playback or pause.

- Each time you press the button, the following indication appears on the screen:

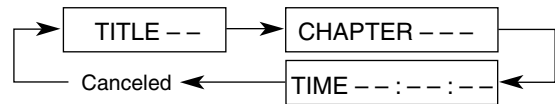

**TITLE --** : Select this to move to another title.

**CHAPTER ---** : Select this to move to another chapter.

**TIME ---:---:---** : Select this to move to a particular scene.

#### 2 Press the number buttons to select a desired title, chapter, or playing time.

The unit starts playback of the selected item. (The on-screen bar appears for a while.)

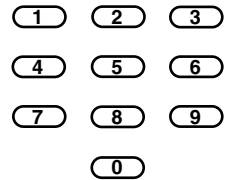

### How to input the title and chapter number

Press the number buttons corresponding to the number, then wait for about 5 seconds or press **ENTER** to start playback.

- To select number 5, press 5, then **ENTER**.
- To select number 12, press 1, 2, then **ENTER**.
- To select number 22, press 2, 2, then **ENTER**.

### How to input the playing time

Press the number buttons to input the playing time, then wait for about 5 seconds or press **ENTER** to start playback at the selected elapsed playing time.

- To input time "00:45:23," press 4, 5, 2, 3.
- To input time "01:23:45," press 1, 2, 3, 4, 5.
- To cancel a mis-entry, press **CLEAR**.

Each time you press the button, the last entry will be erased.

#### Note:

When you want to move to another title directly, you can move to it by simply pressing the corresponding number buttons (without pressing **SEARCH** in step 1).

# DVD Playback

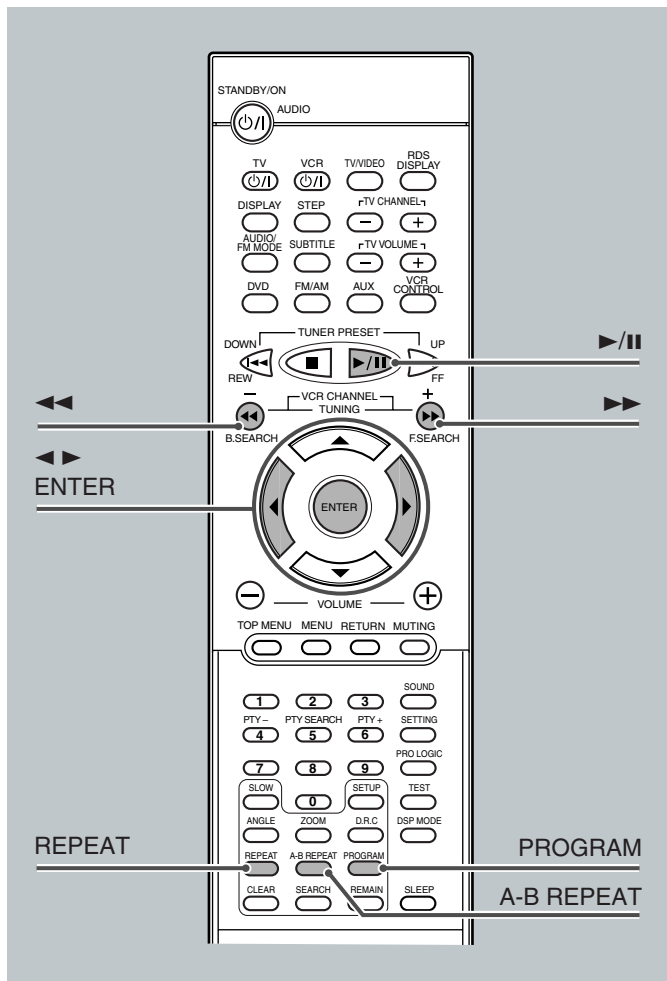

## Searching for a Particular Point

You can search for a particular portion while playing a disc—Variable Speed Forward/Reverse Search.

- No sound comes out during Variable Speed Forward/Reverse Search.

### To fast-forward the chapter—Variable Speed Forward Search

**From the remote control ONLY:**

Press ►► during playback or pause.

- Each time you press the button, the search speed changes as follows:

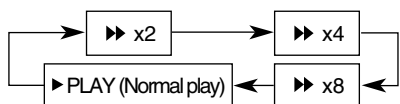

### To reverse the chapter—Variable Speed Reverse Search

**From the remote control ONLY:**

Press ◀◀ during playback or pause.

- Each time you press the button, the search speed changes as follows:

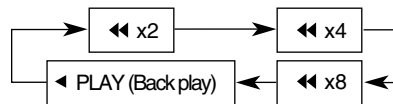

### To resume normal play

Press ►/||.

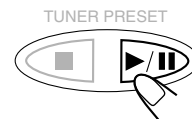

## Repeating Playback

Repeat play cannot be used in the following cases:

- When you enjoy program play

### Repeat Play

**From the remote control ONLY:**

Press REPEAT repeatedly.

The indication corresponding to the selected mode appears on your TV.

- Each time you press the button, Repeat mode changes as follows:

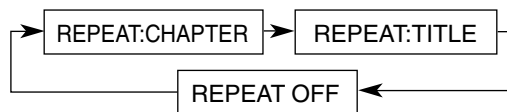

**REPEAT:CHAPTER** : Current chapter will be repeated.

**REPEAT:TITLE** : Current title will be repeated.

**REPEAT OFF** : Repeat play is canceled. (Normal play is resumed.)

### Note:

When the on-screen bar is shown on the TV screen, repeat mode indication also changes as follows:

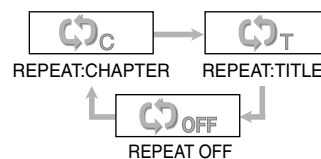

### A-B Repeat

While playing, you can also select a portion you want to repeat.

- A-B repeat is not performed between different titles.
- An interval of more than 5 seconds is required between point A and point B.

Example:

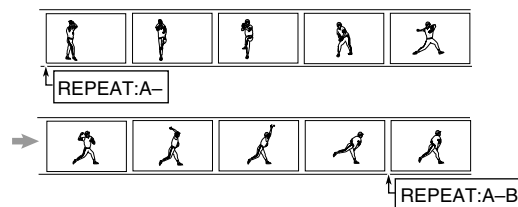

**From the remote control ONLY:**

**1 Press A-B REPEAT to select the start point.**

“RPT A-” appears on the display and “REPEAT:A-” appears on the TV screen.



**2 Press A-B REPEAT again to select the end point.**

“RPT A-” changes to “RPT A-B” and “REPEAT:A-” changes to “REPEAT:A-B,” then A-B repeat begins.

The unit automatically locates point A and starts repeated playback between points A and B.



**To cancel A-B Repeat**

Press A-B REPEAT again.

“RPT OFF” appears on the display and “REPEAT OFF” appears on the TV screen.



**Note:**

When the on-screen bar is shown on the TV screen, Repeat mode indication also changes as follows:

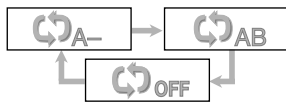

On some DVDs, A-B Repeat may not be used even within the same title. This is due to their disc structures, and not a malfunction of the unit.

**Programming the Playing Order of the Chapters—Program Play**

You can arrange the chapter playback order before you start playing. You can program up to 20 steps.

• Before making a program, make sure that the TV is turned on and the correct input is selected on the TV.

**From the remote control ONLY:**

**1 Load a disc.**

• If the current playing source is not the DVD player, press ►/II, then ■ before going to the next step.

**2 Press PROGRAM.**

The PROGRAM MENU screen appears on the TV screen.

• “PROGRAM” appears on the display.



PROGRAM MENU		SELECT: ENTER	
TITLE	CHAPT	TITLE	CHAPT
1	-- --	6	-- --
2	-- --	7	-- --
3	-- --	8	-- --
4	-- --	9	-- --
5	-- --	10	-- --
PREVIOUS ↑		NEXT ↓	
PLAY: ►		FINISH: PROGRAM	

**3 Press ENTER.**

PROGRAM MENU		SELECT: ENTER	
TITLE	CHAPT	TITLE	CHAPT
1	-- --	6	-- --
2	-- --	7	-- --
3	-- --	8	-- --
4	-- --	9	-- --
5	-- --	10	-- --
CHOOSE: 1-5		NEXT ↓	
PREVIOUS ↑		FINISH: PROGRAM	
PLAY: ►			

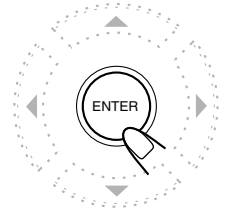

Title numbers you can select in the next step

**4 Press ► or ◀ to select a title number, then ENTER.**

- ► : Increases the number.
- ◀ : Decreases the number.
- You can also select a title number using the number buttons.

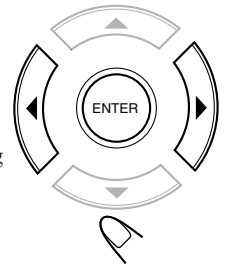

PROGRAM MENU		SELECT: ENTER	
TITLE	CHAPT	TITLE	CHAPT
1	-2 --	6	-- --
2	-- --	7	-- --
3	-- --	8	-- --
4	-- --	9	-- --
5	-- --	10	-- --
CHOOSE: 1-9		NEXT ↓	
PREVIOUS ↑		FINISH: PROGRAM	
PLAY: ►			

Chapter numbers you can select in the next step

**5 Press ► or ◀ to select a chapter number, then ENTER.**

- ► : Increases the number.
- ◀ : Decreases the number.
- You can also select a chapter number using the number buttons.

PROGRAM MENU		SELECT: ENTER	
TITLE	CHAPT	TITLE	CHAPT
1	2 8	6	-- --
2	-- --	7	-- --
3	-- --	8	-- --
4	-- --	9	-- --
5	-- --	10	-- --
PREVIOUS ↑		NEXT ↓	
PLAY: ►		FINISH: PROGRAM	

- To select all chapters in the selected title as one program step, simply press ENTER without selecting any number. “ALL” appears on the chapter number position.

**6 Repeat steps 3 to 5 to program other chapters you want.**

- After 10 steps are programmed, “NEXT ↓” is selected (highlighted). If you want to program more steps, press ENTER.

**7 Press ►/II.**

The chapters are played in the order you have programmed and the PROGRAM indicator lights up.

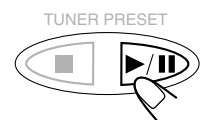

After all the chapters you programmed are played back, the PROGRAM MENU screen appears on the TV screen again.

# DVD Playback

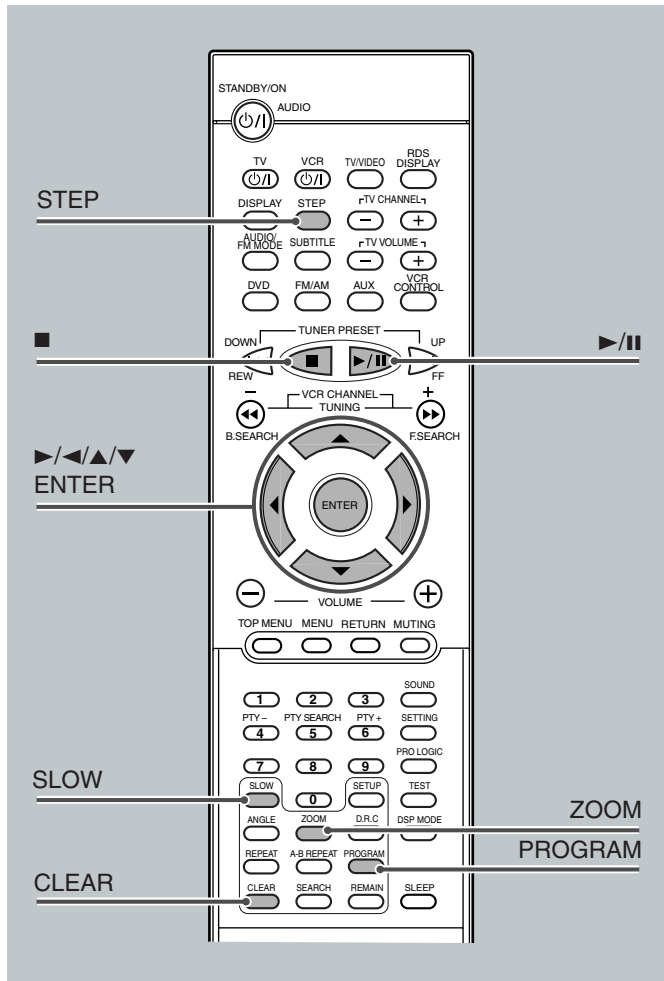

## To erase the stored program

Press **▲** to eject the disc.

- If you turn off the system or change the source, the program is also erased.



## To check the program contents

You can check the program contents by pressing PROGRAM. The PROGRAM MENU screen appears on the TV screen.

- If you press the button during playback, the program play will stop.

## To modify the program

You can modify the program while the PROGRAM MENU screen is shown on the TV screen.

- **To erase a step:** Press **▼** (or **▲**) to select (highlight) an unwanted program step, then press CLEAR.
- **To modify a step:** Press **▼** (or **▲**) to select (highlight) a program step you want to modify, then perform steps **3** to **5** on page 31. (Before entering a new number, press CLEAR repeatedly until “-” appears on the number entry position.)
- **To add a step:** Press **▼** (or **▲**) to select (highlight) an empty program step, then perform steps **3** to **5** on page 31.

- To move program step 11 to program step 10, press **▲** when program step 11 is selected (highlighted) so that “PREVIOUS **↑**” is selected (highlighted). Then, press ENTER.
- To move program step 10 to program step 11, press **▼** when program step 10 is selected (highlighted) so that “NEXT **↓**” is selected (highlighted). Then, press ENTER.

## To stop during playback

Press **■** or PROGRAM on the remote control.

The PROGRAM MENU screen appears on the TV screen.

- If you press **▶/||** while this screen is shown, the unit starts program play.

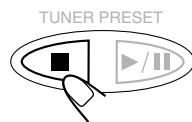

PROGRAM MENU				SELECT: ENTER	
TITLE	CHAPT	TITLE	CHAPT		
1	2	8		6	2
2	1	5		7	2
3	1	17		8	1
4	3	6		9	--
5	4	2		10	--
PREVIOUS <b>↑</b>			NEXT <b>↓</b>		
PLAY: <b>▶</b>			FINISH: PROGRAM		

## To exit from program play

From the remote control ONLY:

Press PROGRAM.

The PROGRAM MENU screen goes off, and the opening screen appears. (The program you made is still kept in memory.)

- If you press **▶/||** while this screen is shown, the unit starts normal playback.



## DVD Special Effect Playback

### ■ Still Picture/Frame-by-Frame Playback

You can advance the still picture frame by frame while playing a DVD.

**From the remote control ONLY:**

#### 1 Press STEP once during playback.

A still picture appears on the TV screen.

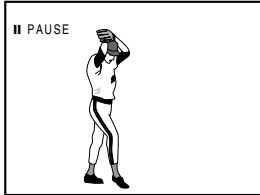

#### 2 Press STEP repeatedly to advance the picture frame by frame.

- Each time you press the button, the picture advances frame by frame.



### To resume normal play

Press ►/II.

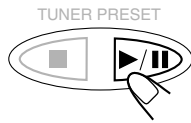

### ■ Slow Motion Playback

You can enjoy slow motion playback while playing a DVD.

**From the remote control ONLY:**

Press SLOW repeatedly during playback or pause.

- Each time you press the button, slow motion speed changes as follows:

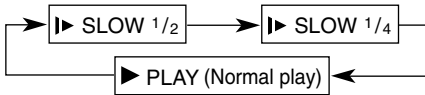

### ■ Zoom

You can zoom in on the picture while playing back a DVD.

**From the remote control ONLY:**

#### 1 Press ZOOM to zoom in.

- Each time you press the button, the picture is enlarged as follows:

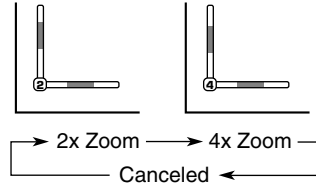

#### 2 Press ►/◄/▲/▼ to move the enlarged portion you want to watch.

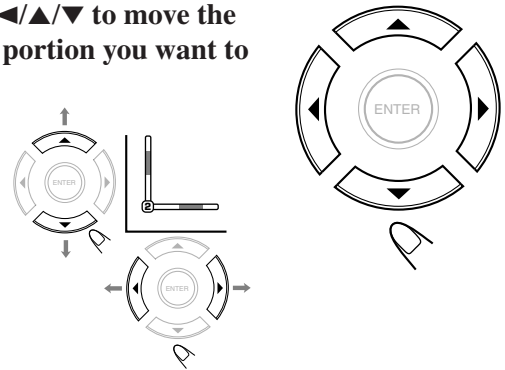

### To cancel the ZOOM

Press ZOOM repeatedly until the normal size picture is resumed.



# VCD/CD Playback

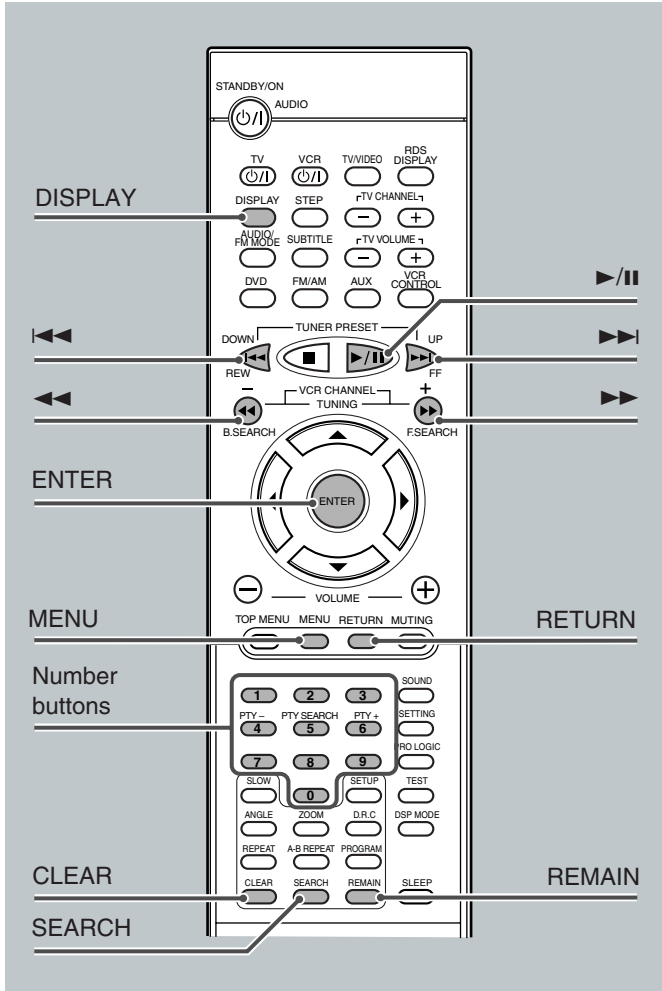

- SVCD can be operated by using the VCD operation procedure.
- For basic disc operations such as inserting a disc, starting playback, and moving to another tracks, see “Basic VCD/CD Operations” on pages 12, 13, and “Basic Disc Operations” on page 26.

## Showing the On-Screen Bar

You can show the following information on the TV screen while a disc is loaded.

- From the remote control ONLY:**  
 Press **DISPLAY**.
- Each time you press the button, the following on-screen bar appears in sequence.



On-screen bar goes off.

- \* Appears only when a VCD is loaded.
- \*\* Appears only when a VCD is played back.

- ①: Disc type  
 DVD VCD SVCD CD MP3
- ②: Current track and total number of the tracks on the disc  
 • Ex.: 1st track is playing out of 35 tracks recorded.
- ③: Sound mode  
 • Ex.: Stereo sound (Left channel and Right channel).
- ④: Play Back Control (PBC) indicator  
 • Ex.: PBC is on. (When PBC is turned off, will appear.)
- ⑤: Repeat mode indicator  
 • Ex.: When repeat mode is turned off. See page 36 for more details.
- ⑥: Elapsed playing time or remaining time  
 You can change the play time indication by pressing **REMAIN**. See below.
- ⑦: Sound indication  
 • Indicates sound input level. (Appears only during playback VCD.)

## Checking the Remaining Time

While playing back a VCD or CD, you can check the remaining time.

- From the remote control ONLY:**  
 Press **REMAIN**.
- The on-screen bar appears on the TV screen for a while.
- Each time you press the button, the play time indication changes as follows:

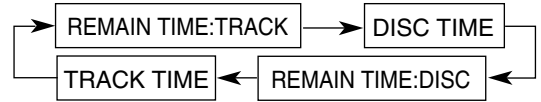

- REMAIN TIME:TRACK**  
 : Select this to show the remaining time of the current track.
- DISC TIME**  
 : Select this to show the total elapsed playing time of the disc.
- REMAIN TIME:DISC**  
 : Select this to show the total remaining time of the disc.
- TRACK TIME**  
 : Select this to show the elapsed playing time of the current track.

## Disc Menu-Driven Playback (Only for VCD)

The Play Back Control function (PBC) allows you to operate the VCD using menus.

When you start playing a VCD with PBC function, a menu will automatically appear on the TV screen. ("MENU" will also appear on the display.)

- A menu may be a list of items, divided screens, or some moving pictures. (See "PBC operation concept" below.)

When a menu appears, you can select a desired item on the menu.

- When a list of items is displayed on the TV screen, press the number buttons to select an item.
- When "▶" or "SELECT" is displayed on the TV screen, press ▶/II to start playback.

### To go to the next submenu

Press ▶▶.



### To return to the previous submenu

Press ◀◀.



### To cancel the PBC playback

You can cancel the menu-driven operations (PBC function):

- 1 Press ■ to stop playback.
- 2 Press the number buttons to select a track.

Normal playback starts from the selected track.

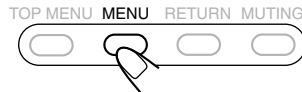

- You can also turn on and off the PBC function by pressing MENU on the remote control. Each time you press the button, the PBC function turns on and off.

### PBC operation concept

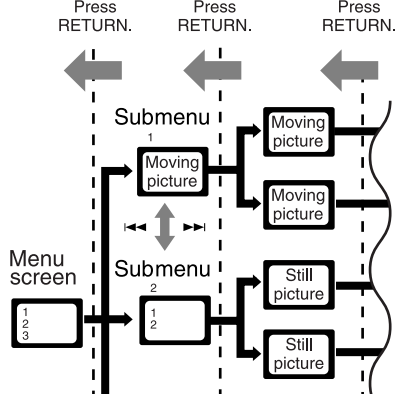

#### Note:

While operating a VCD using menu, some of the functions such as repeat play may not work.

## Moving to a Particular Portion Directly

You can move to a particular portion (scene) on the track directly.

- PBC function is canceled when you use this function.

**From the remote control ONLY:**

### 1 Press SEARCH during playback or pause.

- Each time you press the button, the following indication appears on the TV screen.

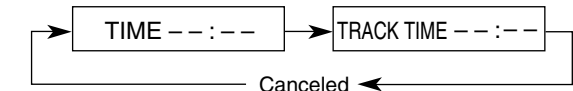

TIME ---:---

: Select this to move to a particular portion on the current disc.

TRACK TIME ---:---

: Select this to move to a particular portion on the current track.

### 2 Press number buttons to select a playing time you want to search for.

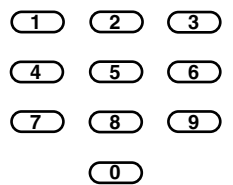

The unit starts playback at the selected elapsed playing time. (The on-screen bar appears for a while.)

- To input time "45:23," press 4, 5, 2, 3.
- To input time "09:45," press 9, 4, 5, then wait for about 5 seconds (or press ENTER).
- To cancel a misentry, press CLEAR. Each time you press the button, the last entry will be erased.

## Searching for a Particular Point

You can search for a particular portion while playing a disc—Variable Speed Forward/Reverse Search.

- No sound comes out during Variable Speed Forward/Reverse Search on a VCD.

### To fast-forward the tracks—Variable Speed Forward Search

Press ▶▶ during playback or pause.

- Each time you press the button, the search speed changes as follows:

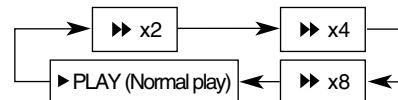

### To reverse the tracks—Variable Speed Reverse Search

Press ◀◀ during playback or pause.

- Each time you press the button, the search speed changes as follows:

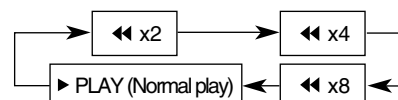

# VCD/CD Playback

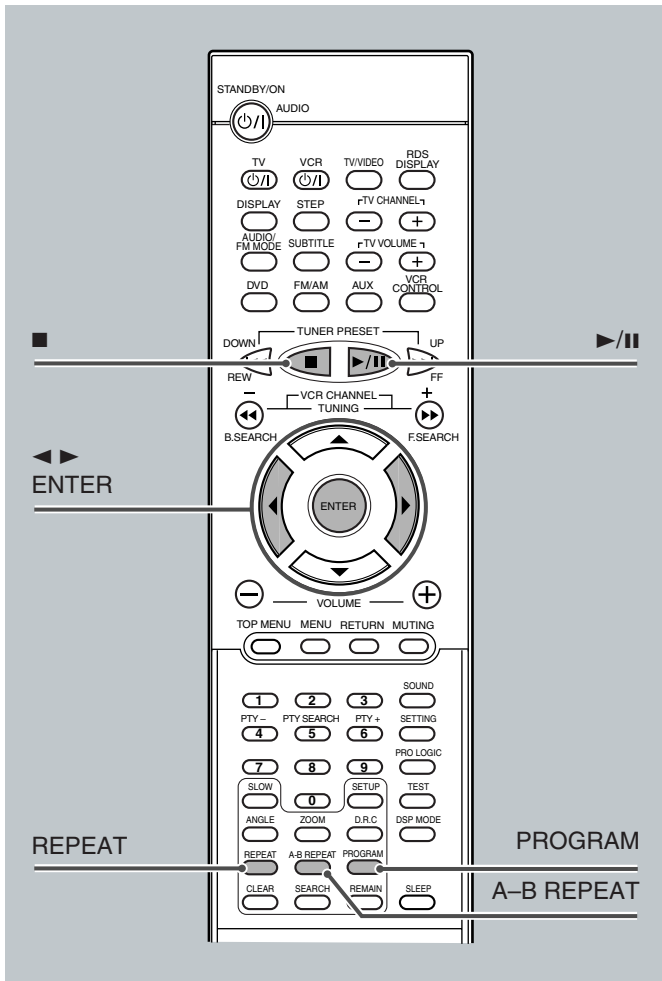

## Repeating Playback

Repeat play cannot be used in the following cases:

- When you play back a VCD using the PBC function
- When you enjoy program play

### Repeat Play

**From the remote control ONLY:**

Press **REPEAT** repeatedly.

The indication corresponding to the selected mode appears on your TV.

- Each time you press the button, repeat mode changes as follows:

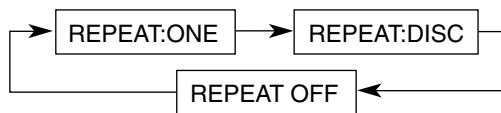

- REPEAT:ONE** : Current track will be repeated.
- REPEAT:DISC** : All the tracks will be repeated.
- REPEAT OFF** : Repeat play is canceled. (Normal play is resumed.)

### Note:

When the on-screen bar is shown on the screen, Repeat mode indication also changes as follows:

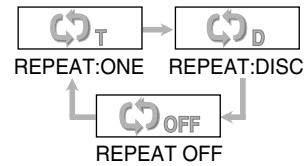

### A-B Repeat

While playing, you can also select a portion you want to repeat.

- An interval of more than 5 seconds is required between point A and point B.

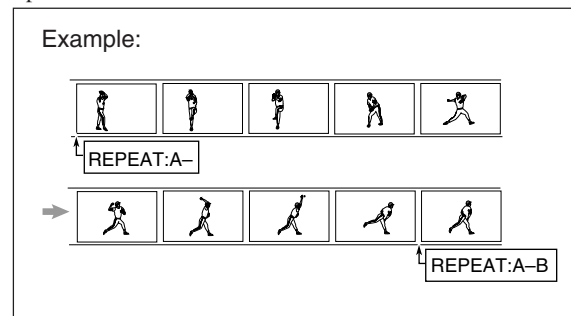

**From the remote control ONLY:**

**1** Press **A-B REPEAT** to select the start point.

“RPT A-” appears on the display and “REPEAT:A-” appears on the TV screen.



**2** Press **A-B REPEAT** again to select the end point.

“RPT A-” changes to “RPT A-B” and “REPEAT:A-” changes to “REPEAT:A-B,” then A-B repeat begins.

The unit automatically locates point A and starts repeated playback between points A and B.



### To cancel A-B Repeat

Press **A-B REPEAT** again.

“RPT OFF” appears on the display and “REPEAT OFF” appears on the TV screen.



### Note:

When the on-screen bar is shown on the TV screen, repeat mode indication also changes as follows:

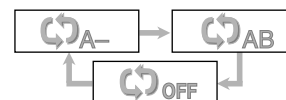



## Programming the Playing Order of the Tracks—Program Play

You can arrange the track playback order before you start playing. You can program up to 20 steps.

- Before making a program, make sure that the TV is turned on and the correct input is selected on the TV.

### From the remote control ONLY:

#### 1 Load a disc.

- If the current playing source is not the DVD player, press ►/II to select the disc you want to play, then ■ before going to the next step.

#### 2 Press PROGRAM.

The PROGRAM MENU screen appears on the TV screen.

- “PROGRAM” appears on the display.

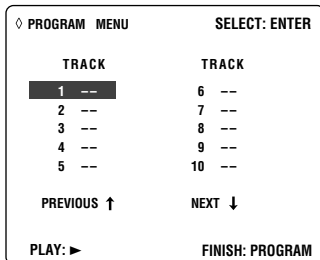

#### 3 Press ENTER.

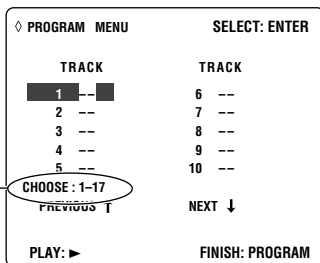

Track numbers you can select in the next step

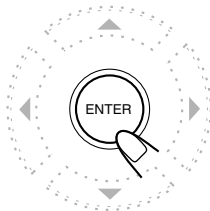

#### 4 Press ► or ◀ to select a track number, then ENTER.

- ► : Increases the number.
- ◀ : Decreases the number.
- You can also select a track number using the number buttons.

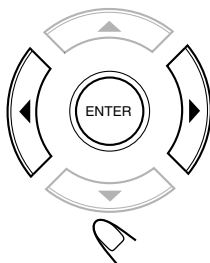
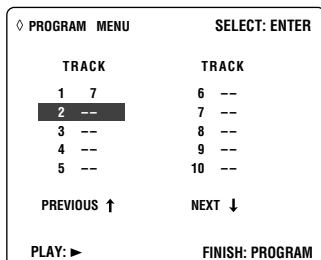

#### 5 Repeat steps 3 and 4 to program other tracks you want.

- After 10 steps are programmed, “NEXT ↓” is selected (highlighted). If you want to program more steps, press ENTER.

#### 6 Press ►/II.

The tracks are played in the order you have programmed and the PROGRAM indicator lights up.



After all the tracks you programmed are played back, the PROGRAM MENU screen appears on the TV screen again.

#### To stop during play

Press ■ or PROGRAM on the remote control.

The PROGRAM MENU screen appears on the TV screen.

- If you press ►/II while this screen is shown, the system starts program play.

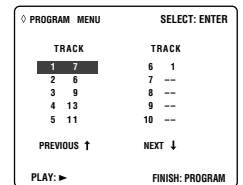
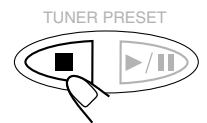

#### To exit from program play

From the remote control ONLY:

Press PROGRAM.

The PROGRAM MENU screen goes off, and the opening screen appears. (The program you made is still kept in memory.)

- If you press ►/II while this screen is shown, the unit starts normal playback.



#### To erase the stored program

Press ▲ to eject the disc.

- If you turn off the system or change the source, the program is also erased.



#### To check the program contents

You can check the program contents by pressing PROGRAM. The PROGRAM MENU screen appears on the TV screen.

- If you press the button during playback, the program play will stop.



TO BE CONTINUED ON THE NEXT PAGE

# VCD/CD Playback

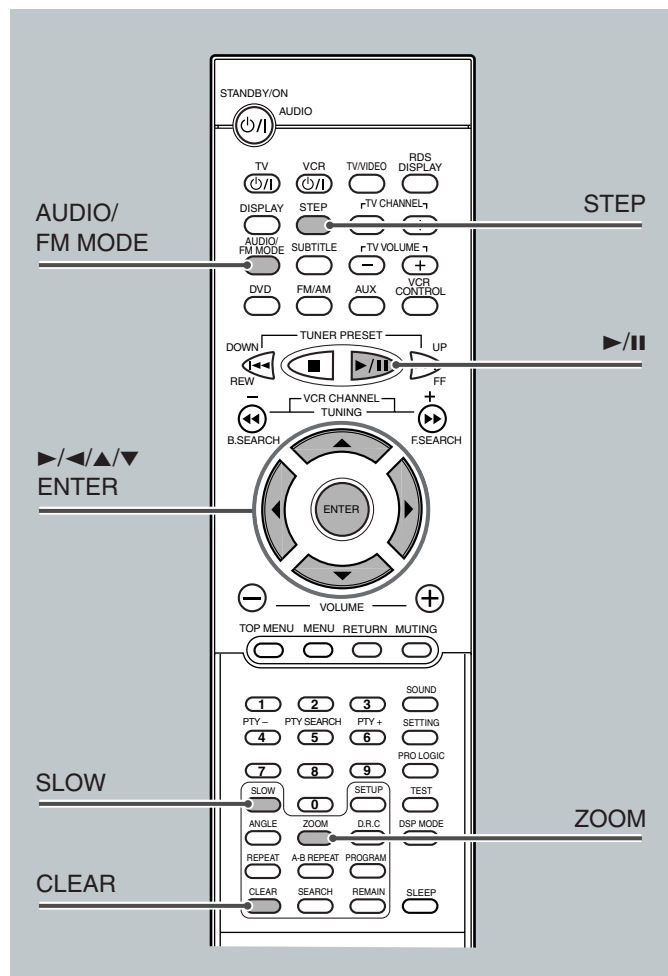

## To modify the program

You can modify the program while the PROGRAM MENU screen is shown on the TV screen.

- **To erase a step:** press ▼ (or ▲) to select (highlight) an unwanted program step, then press CLEAR.
- **To modify a step:** press ▼ (or ▲) to select (highlight) an program step you want to modify, then perform steps **3** and **4**. (Before entering a new number, press CLEAR repeatedly until “- -” appears on number entry position.)
- **To add a step:** press ▼ (or ▲) to select (highlight) an empty program step, then perform steps **3** and **4**.

- To move program step 11 to program step 10, press ▲ when program step 11 is selected (highlighted) so that “PREVIOUS ↑” is selected (highlighted). Then, press ENTER.
- To move program step 10 to program step 11, press ▼ when program step 10 is selected (highlighted) so that “NEXT ↓” is selected (highlighted). Then, press ENTER.

## Selecting Playback Channel

When you play back a karaoke VCD or CD, you can only select either the left channel or right channel to listen to.

Press **AUDIO/FM MODE** repeatedly.

The on-screen bar appears on the screen for a while.

- Each time you press the button, the sound mode changes as follows:

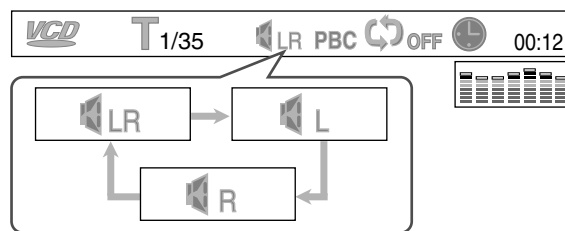
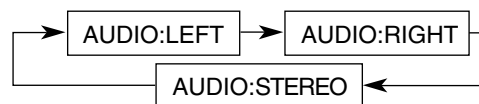

- AUDIO:STEREO (LR)** : Select this to listen to both channel sounds.
- AUDIO:LEFT (L)** : Select this to listen to the left channel sounds.
- AUDIO:RIGHT (R)** : Select this to listen to the right channel sounds.

REMEMBER that after playing back a karaoke VCD or CD using “AUDIO:LEFT” or “AUDIO:RIGHT,” select “AUDIO:STEREO” to restore normal stereo playback.

## VCD Special Effect Playback

### ■ Still Picture/Frame-by-Frame Playback

You can advance the still picture frame by frame while playing a VCD.

**From the remote control ONLY:**

#### 1 Press STEP once during playback.

A still picture appears on the TV screen.

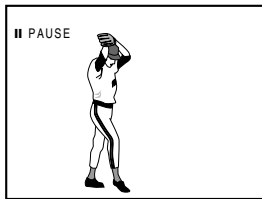

#### 2 Press STEP repeatedly to advance the picture frame by frame.

- Each time you press the button, the picture advances frame by frame.



### To resume normal play

Press ►/II.

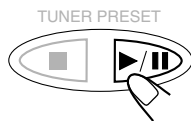

### ■ Slow Motion Playback

You can enjoy slow motion playback while playing a VCD.

**From the remote control ONLY:**

Press SLOW repeatedly during playback or pause.

- Each time you press the button, slow motion speed changes as follows:

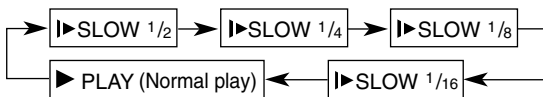

### ■ Zoom

You can zoom in on the picture while playing a VCD.

**From the remote control ONLY:**

#### 1 Press ZOOM to zoom in.

- Each time you press the button, the picture is enlarged as follows:

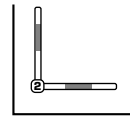

2x Zoom ←→ Canceled

#### 2 Press ►/◀/▲/▼ to move the enlarged portion you want to watch.

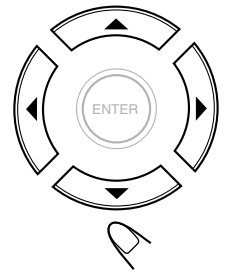
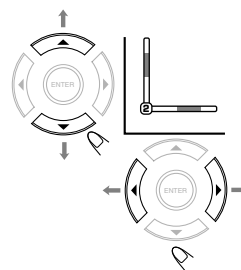

### To cancel the ZOOM

Press ZOOM again.

The normal size picture is resumed.



# MP3 Introduction

This system is incorporated with an MP3 decoder. You can play back MP3 tracks (files) recorded on CD-Rs and CD-RWs.

- Notice that “files” and “tracks” are used interchangeably.

## What is MP3?

MP3 is an abbreviation of Motion Picture Experts Group (or MPEG) Audio Layer 3. MP3 is simply a file format with a data compression ratio of 1:10 (128 Kbps\*). That means, by using MP3 format, one CD-R or CD-RW can contain 10 times as much data volume as a regular CD can.

\* Bit rate is the average number of bits that one second of audio data will consume. The measuring unit used is Kbps (1000 bits per second).

To get a better audio quality, choose a higher bit rate. The most popular bit rate for encoding (recording) is 128 Kbps.

## MP3 File Compatibility

- This system can only read MP3 files that are recorded in the format that is compliant with ISO 9660 Level 1 or Level 2.
- The system can read or play MP3 files only with the extension code—“.mp3”.
- ID3\* tags cannot be shown on the display.
- \* An MP3 file can contain file information called “ID3 Tag” where its album name, performer, track title, etc. are recorded. There are two versions—ID3v1 (ID3 Tag version 1) and ID3v2 (ID3 Tag version 2).

## Disc structure—How are MP3 files recorded and played back?

“MP3 files (tracks)” can be recorded in “directories (or folders),” in PC terminology.

During recording, the files and directories can be arranged in a way similar to arranging files and folder/directories of computer data.

“Root” is similar to the root of a tree. Every file and directory can be linked to the root.

In compliance with ISO 9660, the maximum allowable depth of nested directories—so-called “hierarchy”—is eight (inclusive of the root).

Playback order, files search order, and directory search order of the MP3 files recorded on a disc are determined by the writing (or encoding) application; therefore, playback order may be different from the one you have intended while recording the folders/directories and the files.

## Note on MP3 discs

MP3 discs (either CD-R or CD-RW) require a longer readout time. (It differs due to the complexity of the directory/file configuration.)

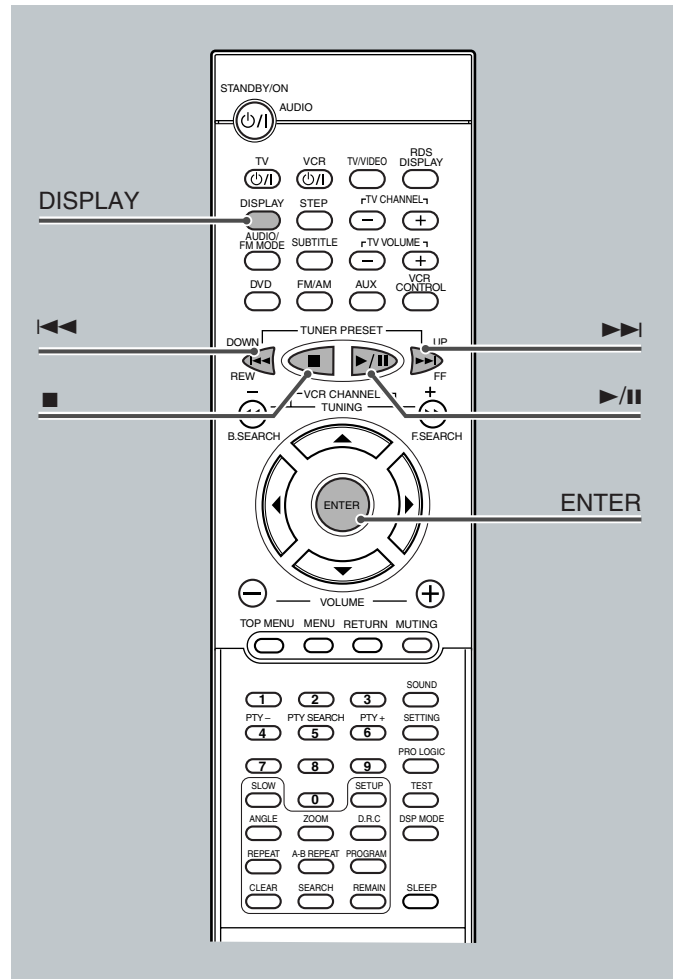

For in-depth information about a disc to be played back, see “Disc Introduction—DVD/VCD/CD” on page 25.

# MP3 Playback

## Starting Playback

It is recommended to turn on your TV when playing back an MP3 disc.

**1** Press **▲** to load a disc.

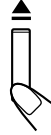

**2** Press **▶/||**.

After detecting the disc, playback starts.

- The on-screen bar and the contents recorded on the MP3 disc will be shown on the TV if it is turned on.

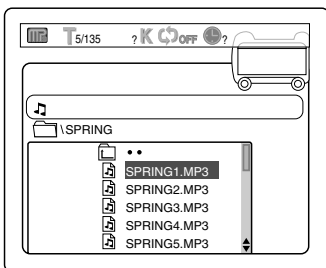
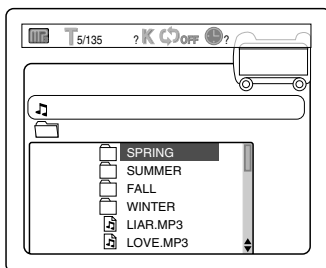
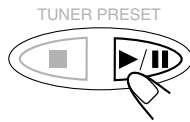

### Note:

If the loaded disc is not recorded in the audio CD format or MP3 format, "WRONG DISC FORMAT" appears on the TV screen.

## The on-screen bar

①	②	③	④	⑤	⑥
① : Disc type					
DVD  VCD  SVCD  CD  MP3					
② : Current track (file) and total number of the tracks on the disc					
• Ex.: 1st track is playing out of 35 tracks recorded.					
③ : Bit rate					
• Ex.: Bit rate used for recording the loaded disc is 128 Kbps. (See the previous page.)					
④ : Repeat mode indicator					
• Ex.: When repeat mode is turned off. See page 43 for more details.					
⑤ : Elapsed playing time and the total playing time of the current track					
⑥ : Sound indication					
• Indicates sound input level. (Only appears during playback.)					

## To go to another track

Press **▶▶|** or **||◀◀** during playback.

- ▶▶|** : Skip to the beginning of the next track.



- ||◀◀** : Skip to the beginning of the previous track.



## To stop playback for a moment

Press **▶/||**.

To resume play, press **▶/||** again or ENTER.

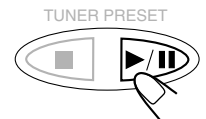

## To stop during playback

Press **■**.

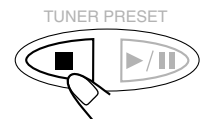

## To remove the disc

Press **▲** on the front panel.

The disc tray comes out.

To close the disc tray, press **▲** again.



# MP3 Playback

## Operations Using the On-Screen Display

It is recommended to turn on your TV when playing back an MP3 disc.

When the loaded MP3 disc is recognized, the following on-screen display appears on the TV screen. (The contents of this on-screen display varies according to the disc—the way MP3 tracks were recorded on the disc.)

- Only the first 8 letters of the titles appear on the TV screen.

### From the remote control ONLY:

Button	To do
ENTER	Start playback or go into a directory.
▼ / ▲	Select a track or directory.

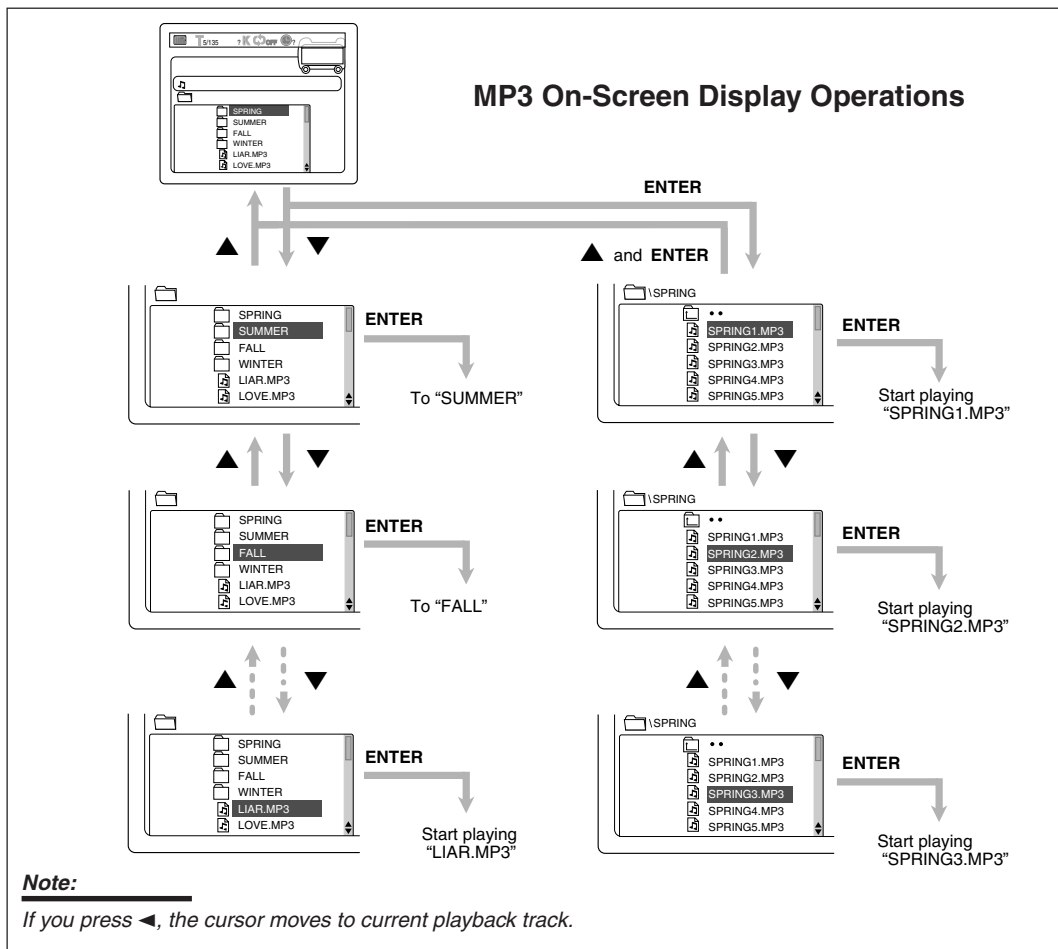
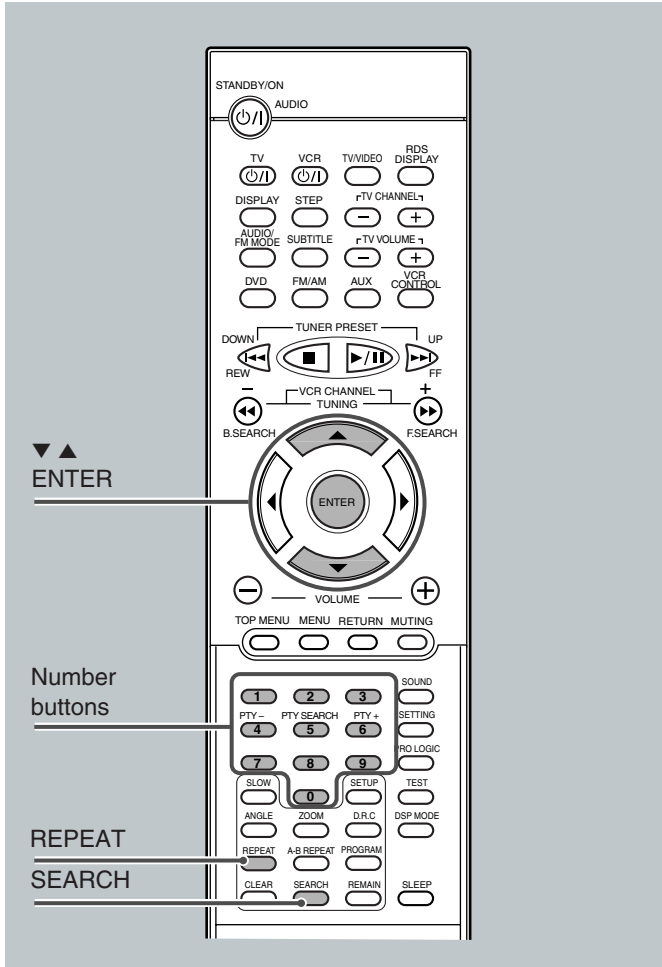

## Moving to a Particular Track Directly

You can move to a particular track on the disc directly.

**From the remote control ONLY:**

**1** Press **SEARCH** during playback or pause.

“TRACK ----” appears on the TV screen.



**2** Press the number buttons to select a track number you want.

The system starts playback from the selected track.

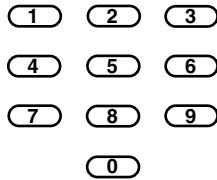

- To select number 5, press 5 (then ENTER).
- To select number 10, press 1, 0 (then ENTER).
- To select number 23, press 2, 3 (then ENTER).
- To select number 123, press 1, 2, 3.



**Note:**

When you want to move to another file (track) directly, you can move to it simply by pressing the number buttons (without pressing **SEARCH** in step 1).

## Repeating Playback

On an MP3 disc, A–B repeat cannot be used. You can enjoy only repeat play.

**From the remote control ONLY:**

**To repeat playback—Repeat Play**

Press **REPEAT** repeatedly.

The indication corresponding to the selected mode appears on the TV screen.



- Each time you press the button, repeat mode changes as follows:

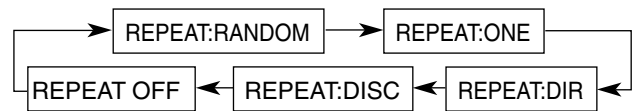

**REPEAT:RANDOM**

: All tracks recorded on the disc will be played once at random (random play), and random play will be repeated.

**REPEAT:ONE**

: Current track will be repeated.

**REPEAT:DIR**

: Tracks in the current directory will be repeated.

**REPEAT:DISC**

: All tracks on the disc will be repeated.

**REPEAT OFF**

: Repeat play is canceled. (Normal play is resumed.)

**Note:**

When the on-screen bar is shown on the TV screen, repeat mode indication also changes as follows:

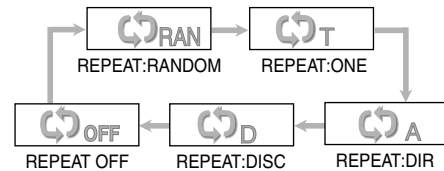

# Tuner Operations

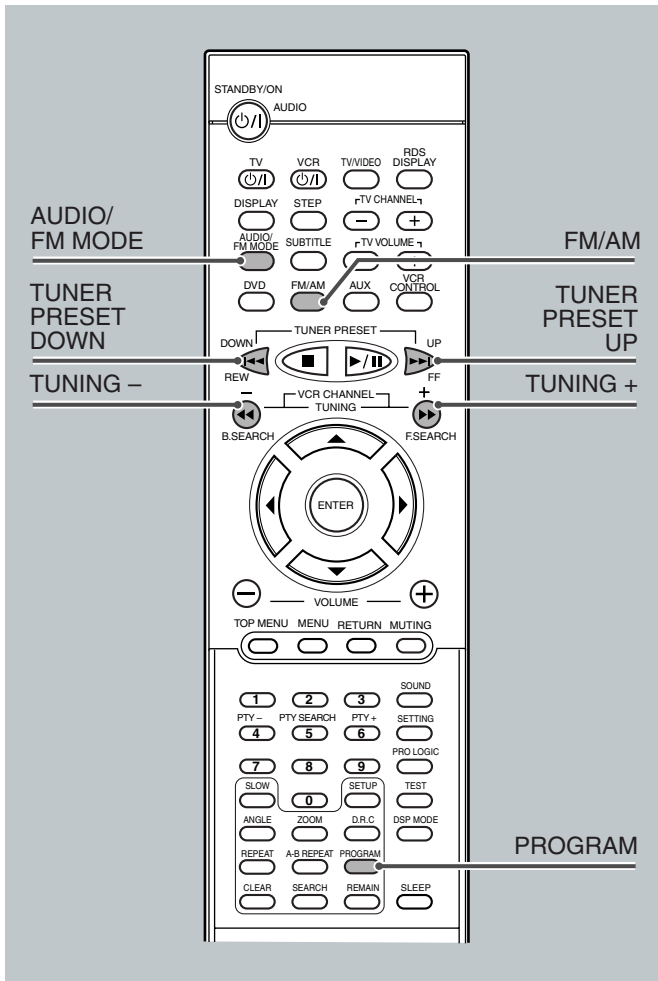

For basic tuner operations, see “Basic Tuner Operations” on page 14.

## Tuning in Stations

**From the remote control:**

**1 Press FM/AM repeatedly to select the band.**

The last received station of the selected band is tuned in.

- Each time you press the button, the band alternates between FM and AM.



**2 Press and hold TUNING + or - until you find the frequency you want.**

- TUNING + : Increases the frequency.
- TUNING - : Decreases the frequency.

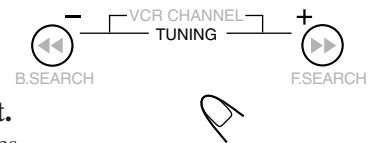

The system starts searching for stations and stops when a station of sufficient signal strength is tuned in.

**On the front panel:**

**1 Press SOURCE repeatedly until the desired band appears on the display.**

The last received station of the selected band is tuned in.

- Each time you press the button, the source changes as follows:

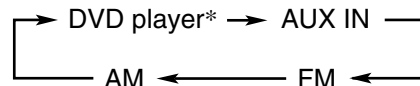

\* “WAIT” appears on the display.

**2 Press ■ so that “MANUAL” appears on the display.**

- Each time you press the button, the operation mode of ►►| and |◀◀ buttons alternates between “PRESET” and “MANUAL.”

**PRESET** : Select this for using ►►| and |◀◀ as the buttons to select the preset station.

**MANUAL** : Select this for using ►►| and |◀◀ as the buttons to change the frequency manually.

**3 Press and hold ►►| or |◀◀ until you find the frequency you want.**

- ►►| : Increases the frequency.
- |◀◀ : Decreases the frequency.



**Notes:**

- When a station of sufficient signal strength is tuned in, the **TUNED** indicator lights up on the display.
- When an FM stereo program is received, the **ST** indicator also lights up.
- When you press the button repeatedly, the frequency changes step by step.



## Using Preset Tuning

Once a station is assigned to a channel number, the station can be quickly tuned. You can preset up to 15 FM and 15 AM stations.

### To store the preset stations

**From the remote control ONLY:**

**1** Tune in the station you want to preset (see “Tuning in Stations”).

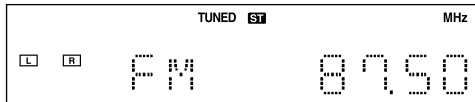

**2** Press PROGRAM.

The preset number appears on the display and the PROGRAM indicator lights up.

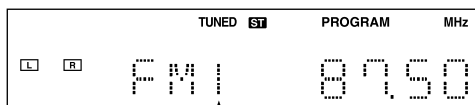

Preset number

**3** Press TUNER PRESET UP or DOWN to select a preset number.



**4** Press PROGRAM to store the preset station.

The PROGRAM indicator goes off, and the station is assigned to the selected preset number.



**5** Repeat steps 1 to 4 until you store all the stations you want.

### To erase a stored preset station

Storing a new station on a used number erases the previously stored one.

### To tune in a preset station

**From the remote control:**

**1** Press FM/AM repeatedly to select the band.



The last received station of the selected band is tuned in.

- Each time you press the button, the band alternates between FM and AM.

**2** Press TUNER PRESET UP or DOWN until the desired preset station appears on the display.



- TUNER PRESET UP : Increases the preset number.
- TUNER PRESET DOWN : Decreases the preset number.

**On the front panel:**

**1** Press SOURCE repeatedly until the desired band appears on the display.



**2** Press ■ so that “PRESET” appears on the display.



- Each time you press the button, the operation mode of ►► and ◀◀ buttons alternates between “PRESET” and “MANUAL.”

**PRESET** : Select this for using ►► and ◀◀ as the buttons to select the preset station.

**MANUAL** : Select this for using ►► and ◀◀ as the buttons to change the frequency manually.

**3** Press ►► or ◀◀ repeatedly until the desired preset station appears on the display.



- ►► : Increases the preset number.
- ◀◀ : Decreases the preset number.

## Selecting the FM Reception Mode

When an stereo FM program tuned currently is noisy, you can change the FM reception mode to improve the reception.

**Press AUDIO/FM MODE.**

The **ST** indicator goes off from the display and the program loses the stereo effect.



**To resume the stereo effect,** press AUDIO/FM MODE again. The stereo effect resumes.

**Note:**

The FM reception mode will also resume in the following case:

- When you change the frequency, the preset number, or the band

# Tuner Operations

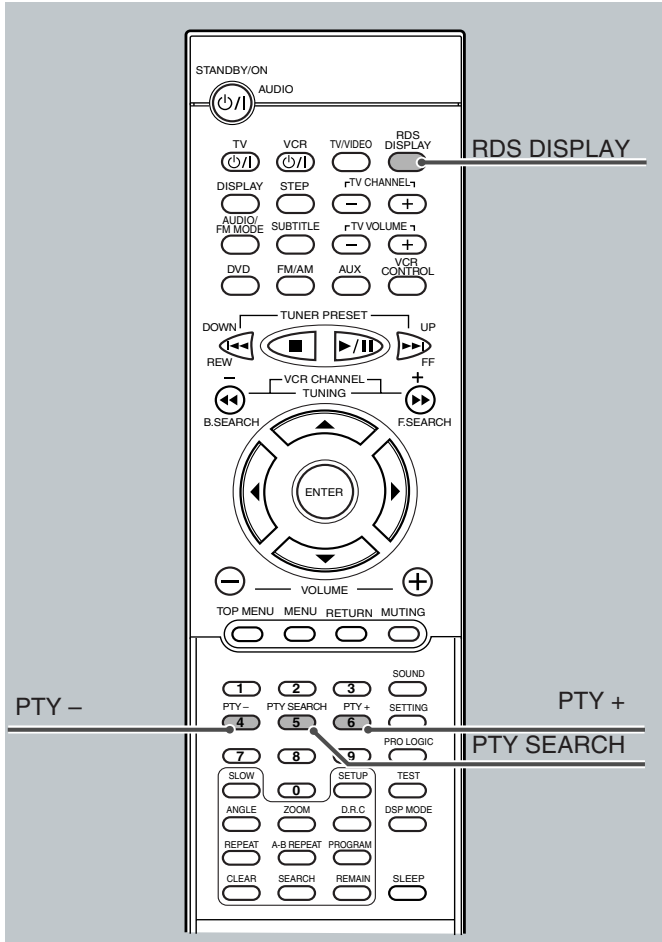

If the remote control is not for the tuner operations, the button for the RDS operations—PTY + and –, and PTY SEARCH—do not work. In this case, press FM/AM on the remote control so that the remote control can be used for the tuner operation.

## Using the RDS (Radio Data System) to Receive FM Stations

RDS allows FM stations to send an additional signal along with their regular program signals. For example, the stations send their station names, as well as information about what type of program they broadcast, such as sports or music, etc.

When tuned to an FM station which provides the RDS service, the RDS indicator lights up on the display.

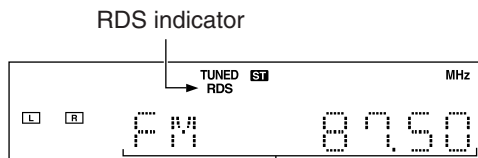

Then, the display shows its PS name.

### Notes:

- RDS is not available for AM broadcasts.
- RDS may not operate correctly if the tuned station is not transmitting RDS signals properly or if the signal strength is weak.

## What information can RDS signals provide?

You can see the following RDS signals the station sends on the display.

### PS NAME (Program Service):

While searching, “PS NAME” appears, then the station names will be displayed. “NO PS” appears if no signal is sent.

### RT (Radio Text):

While searching, “RT” appears, then text messages the station sends will be displayed. “NO RT” appears if no signal is sent.

### CT (Clock Time):

While searching, “CT” appears, then clock signals the station sends will be displayed. “NO CT” appears if no signal is sent.

### Frequency:

Station frequency (non-RDS service)

### From the remote control ONLY:

Make sure that the remote control is for the tuner operation. If not, press FM/AM on the remote control so that the remote control can be used for the tuner operation.

Press RDS DISPLAY while listening to an FM station to show the RDS signals.

- Each time you press the button, the display changes to show the following information:

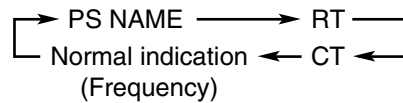

To check the PTY, press PTY SEARCH once so that the current PTY code appears.

- “NO PTY” appears if no signal is sent.

### About characters shown on the display

When the display shows PS NAME, RT, or CT signals, the following characters are used.

- The display cannot differentiate upper case and lower case letters and always uses upper case letters.
- The display cannot show accented letters, “A,” for instance, may stand for accented “A’s” like “À, Ä, Ã, Á, À, Â, ã, ä, ã, á, à, and â.”

### Note:

If searching finishes at once, “PS NAME,” “RT,” and “CT” will not appear on the display.

## Searching for a Program by PTY Codes

One of the advantages of the RDS service is that you can locate a particular kind of program from the preset channels (see page 45) by specifying the PTY codes.

### To search for a program using the PTY codes

#### Before you start, remember...

- The PTY Search is only applicable to preset stations.
- There is a time limit in doing the following steps. If the setting is canceled before you finish, start from step 1 again.

#### From the remote control ONLY:

Make sure that the remote control is for the tuner operation. If not, press FM/AM on the remote control so that the remote control can be used for the tuner operation.

#### 1 Press PTY SEARCH while listening to an FM station.

The currently selected PTY code appears on the display.



#### 2 Press PTY + or PTY - until the PTY code you want appears on the display.

- For details, see “Description of the PTY codes” on page 48.

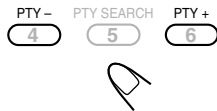

#### 3 Press PTY SEARCH again, while the PTY code selected in the previous step is still on the display.

The system searches FM preset stations, stops when it finds the one you have selected, and tunes in that station.



#### To stop during searching

Press PTY SEARCH again.



### PTY codes

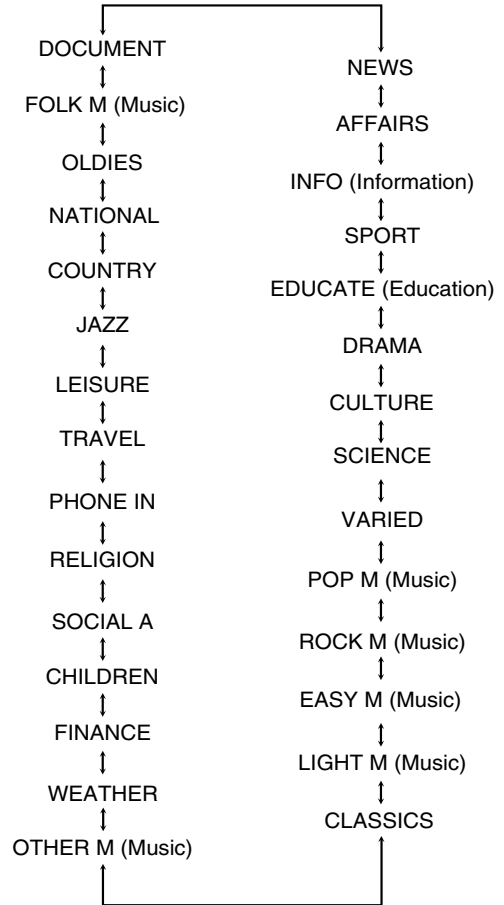

# Tuner Operations

## ■ Description of the PTY codes:

<b>NEWS:</b>	News.	<b>WEATHER:</b>	Weather reports and forecasts.
<b>AFFAIRS:</b>	Topical program expanding or enlarging upon the news—debate, or analysis.	<b>FINANCE:</b>	Stock Market reports, commerce, trading etc.
<b>INFO:</b>	Programs the purpose of which is to impart advice in the widest sense.	<b>CHILDREN:</b>	Programs targeted at a young audience.
<b>SPORT:</b>	Programs concerned with any aspect of sports.	<b>SOCIAL A:</b>	Programs about sociology, history, geography, psychology and society.
<b>EDUCATE:</b>	Educational programs.	<b>RELIGION:</b>	Religious programs.
<b>DRAMA:</b>	All radio plays and serials.	<b>PHONE IN:</b>	Involving members of the public expressing their views either by phone or at a public forum.
<b>CULTURE:</b>	Programs concerning any aspect of national or regional culture, including language, theater, etc.	<b>TRAVEL:</b>	Travel information.
<b>SCIENCE:</b>	Programs about natural sciences and technology.	<b>LEISURE:</b>	Programs about recreational activities.
<b>VARIED:</b>	Used for mainly speech-based programs such as quizzes, panel games and personality interviews.	<b>JAZZ:</b>	Jazz music.
<b>POP M:</b>	Commercial music of current popular appeal.	<b>COUNTRY:</b>	Songs which originate from, or continue the musical tradition of the American Southern States.
<b>ROCK M:</b>	Rock music.	<b>NATIONAL:</b>	Current popular music of the nation or region in that country's language.
<b>EASY M:</b>	Current contemporary music considered to be "easy-listening."	<b>OLDIES:</b>	Music from the so-called "golden age" of popular music.
<b>LIGHT M:</b>	Instrumental music, and vocal or choral works.	<b>FOLK M:</b>	Music which has its roots in the musical culture of a particular nation.
<b>CLASSICS:</b>	Performances of major orchestral works, symphonies, chamber music, etc.	<b>DOCUMENT:</b>	Programs concerning factual matters, presented in an investigative style.
<b>OTHER M:</b>	Music not fitting into any of the other categories.		

Classification of the PTY codes for some FM stations may be different from the above list.

**MEMO**

FM 1

FM 2

FM 3

FM 4

FM 5

FM 6

FM 7

FM 8

FM 9

FM 10

FM 11

FM 12

FM 13

FM 14

FM 15

AM 1

AM 2

AM 3

AM 4

AM 5

AM 6

AM 7

AM 8

AM 9

AM 10

AM 11

AM 12

AM 13

AM 14

AM 15

# Setting up the DVD Preferences

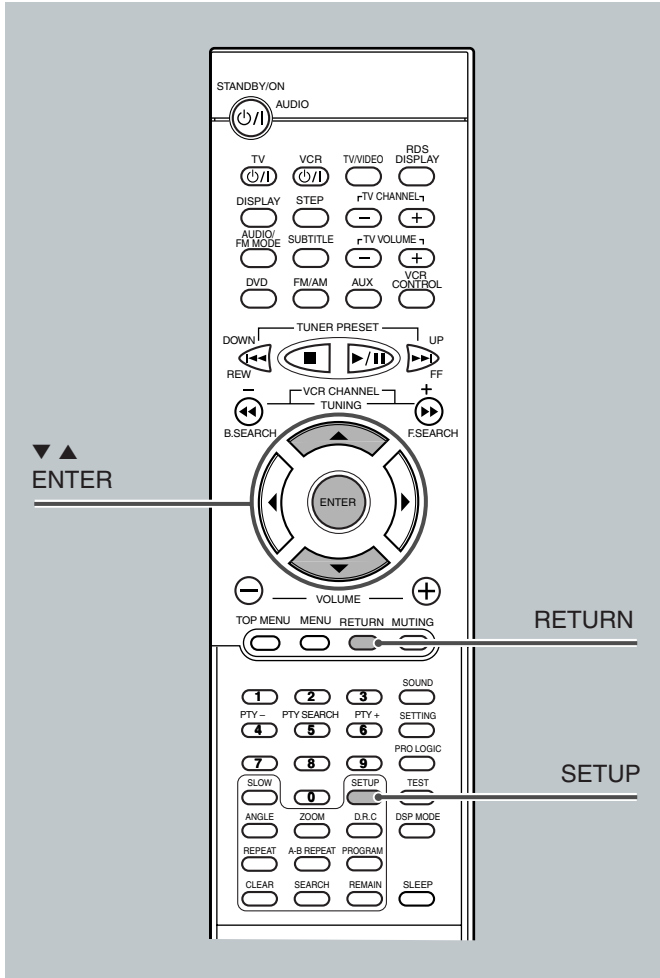

On the Setup menu, you can do the two main important settings—language selection (LANGUAGES) menu and system setting (SYSTEM) menu.

- Setup menu can only be displayed while a disc is not playing. (The DVD player must be selected as the source.)
- You can only use the remote control for Setup menu operations.

## Setting the Initial Languages

You can select your favorite language you listen to or read on the TV screen.

When you operate this system or watch a DVD, you will be able to operate the system or to enjoy a DVD in the language you have selected and stored.

On the language selection menu, you can select the following:

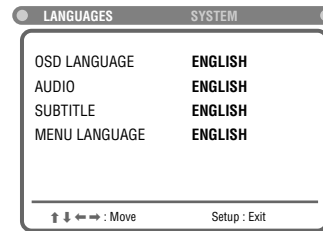

**OSD LANGUAGE** : Select the indication language shown on the TV screen while operating the system. (ex. PLAY, STOP, PAUSE, etc.)

**AUDIO** : Select the language you listen to while watching a DVD.

**SUBTITLE** : Select the subtitle language you read while watching a DVD.

**MENU LANGUAGE** : Select the menu language recorded on a DVD which you use while operating the DVD's own menu.

## Languages you can select on this menu

You can select the following languages separately for each listed item on the menu.

- For **“OSD LANGUAGE”**: English, Chinese, Spanish, French, German, Japanese, and Korean.
- For **“AUDIO,” “SUBTITLE,” and “MENU LANGUAGE”**: English, Chinese, French, German, Japanese, Russian, Spanish, Portuguese, Korean and Original\*.

\* Available only for “AUDIO” and “SUBTITLE.”

When you want to operate the disc or enjoy its playback in the originally recorded (default) language, select “ORIGINAL.”

### Note:

The original language will be selected as the initial language regardless of your setting in the following cases:

- If the language you have selected is not recorded on the disc.
- If the disc is programmed to be played back in the original language.

## ■ Basic language selecting procedure

Ex. : To select the desired language as the initial language for "AUDIO."

**From the remote control ONLY:**

### 1 Press SETUP.

Language selection menu of the Setup menu appears on the TV screen.

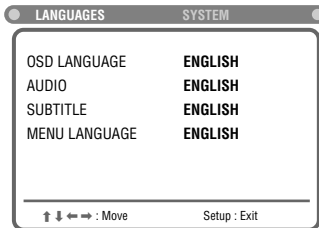

### 2 Press ▼ (or ▲) to select (highlight) one of the language items.

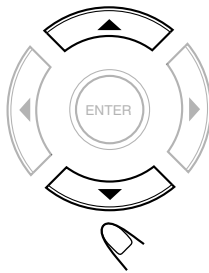
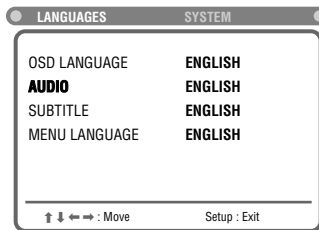

### 3 Press ENTER.

Pop-up window appears (where the language names are listed).

✓ indicates the current setting.

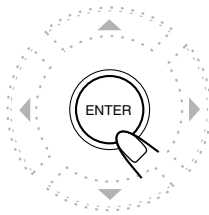
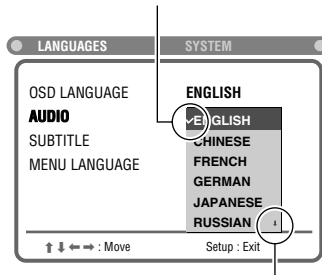

↓ indicates that more languages are listed, but not shown.

### 4 Press ▼ (or ▲) to select (highlight) the language you want, then press ENTER.

The setting is stored (and the pop-up window goes off).

- When you want to cancel the setting you have just made, press RETURN without pressing ENTER. (Pop-up menu also goes off.)

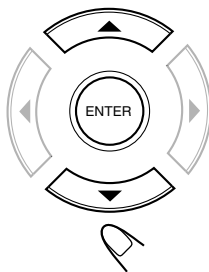

### 5 Repeat steps 2 to 4 to select the other language items listed.

## To erase the Setup menu

Press SETUP.





## Introducing the DVD Preference (System)

You can set the DVD preference to match it to your usage and operating circumstances.

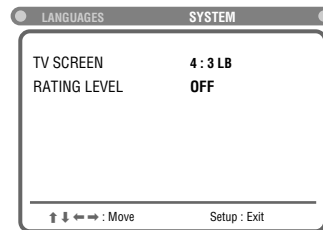
On the system setting menu, you can set the following:

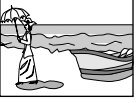

**TV SCREEN:** Select the TV screen size for playing back a DVD recorded with 16:9 wide screen video signal.

- **4:3 LB** : Select "4:3 LB (Letter Box)" when the aspect ratio of your TV is 4:3. While viewing a wide screen picture, the black bars appear on the top and the bottom of the screen. 
- **4:3 PS** : Select "4:3 PS (Pan-Scan)" when the aspect ratio of your TV is 4:3. While viewing a wide screen picture, the black bars do not appear, however, the left and right edge sides of the pictures will not be shown on the screen. 
- **16:9** : Select "16:9" when the aspect ratio of the TV is 16:9. (Set the screen size to full on your TV.) 

**RATING LEVEL:** You can select this to restrict playback of DVDs containing violent scenes and those not suitable for your family members. (See page 53 for detailed operations.)

# Setting up the DVD Preferences

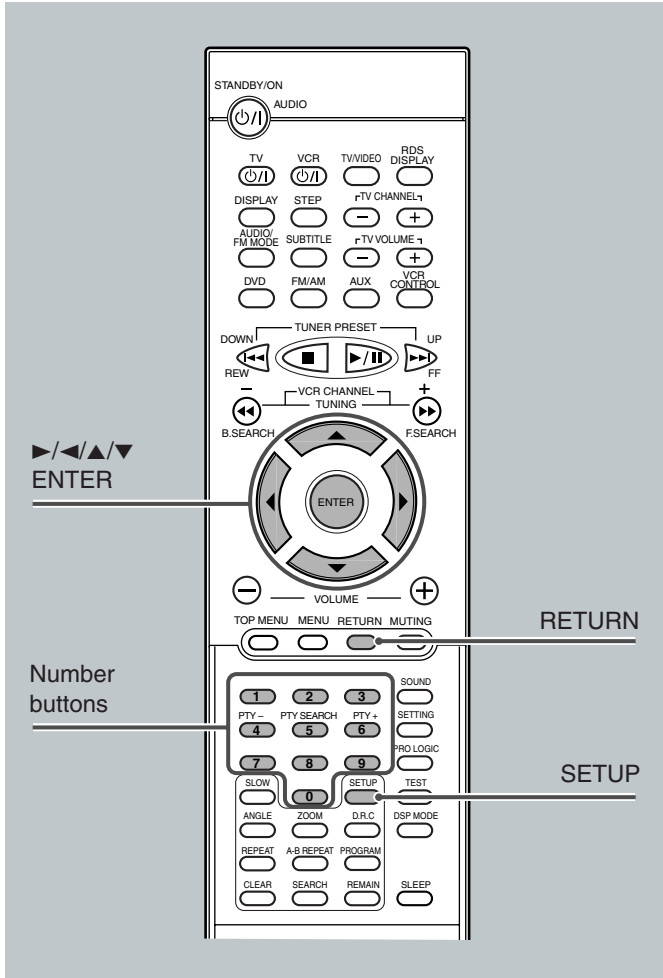

**3** Press ▼ (or ▲) to select (highlight) one of the system setting items listed on the menu.

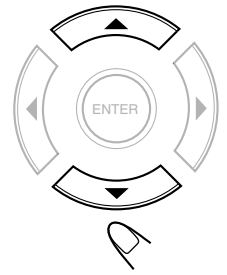
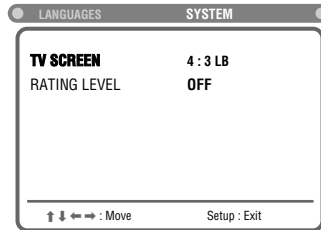

**4** Press ENTER.

Pop-up window appears (where the selectable settings are listed).

✓ indicates the current setting.

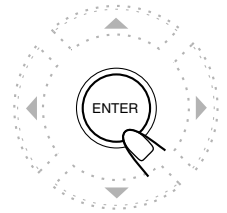
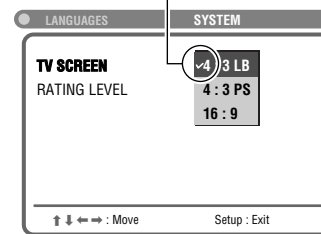

**5** Press ▼ (or ▲) to select (highlight) the proper setting, then press ENTER.

The setting is stored (and the pop-up window goes off).

- When you want to cancel the setting you have just made, press RETURN without pressing ENTER. (Pop-up menu also goes off.)

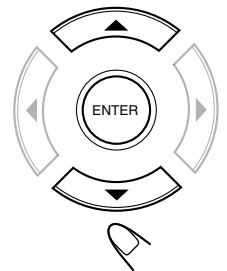

## ■ Setting the TV screen size

**From the remote control ONLY:**

**1** Press SETUP.

Language selection menu of the setup menu appears on the TV screen.

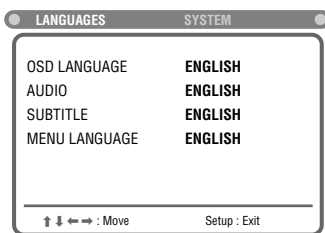

**2** Press ENTER (or ►/◀) to select (highlight) the system setting menu.

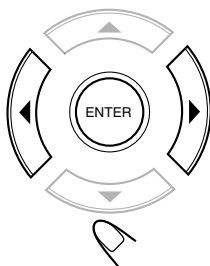
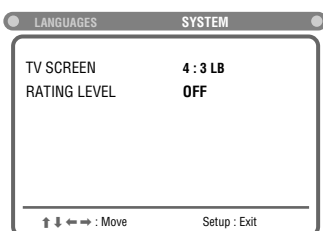

- Even if "4:3 PS" is selected, the screen size may become "4:3 LB" while playing some DVDs. This depends on how the DVD is programmed and recorded.
- If a disc (or some portions of the disc) is recorded with the video signals of 4:3 aspect ratio, this setting does not take effect. The pictures are displayed with full 4:3 aspect ratio or with 4:3 Letter Box.

## To erase the Setup menu

Press SETUP.





## Setting the Parental (Rating) Level

Using this function, you can restrict playback of DVD containing violent scenes and those not suitable for your family members. Nobody can play such a disc unless this function is canceled. (“WRONG PARENTAL CODE” appears on the display if you try to play back such a disc.)

- This setting takes effect only for the DVDs containing the rating level information—Level 1 (most restrictive) to Level 8 (least restrictive).

**From the remote control ONLY:**

### 1 Press SETUP.

Language selection menu of the setup menu appears on the TV screen.



### 2 Press ENTER (or ►/◀) to select (highlight) the system setting menu.

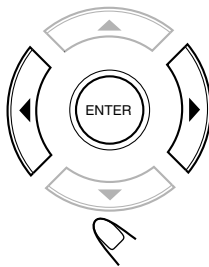
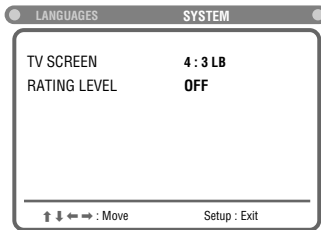

### 3 Press ▼ (or ▲) to select (highlight) “RATING LEVEL.”

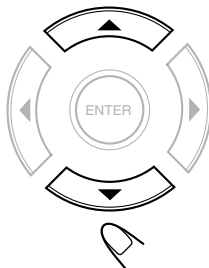
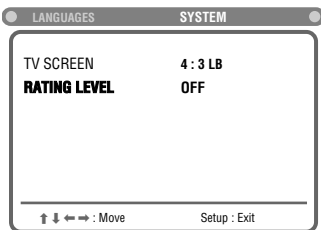

### 4 Press ENTER.

“RATING LEVEL” now changes to “ENTER PASSWORD” on the menu.

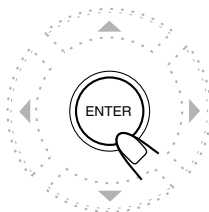
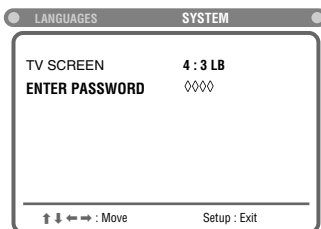

### 5 Press the number buttons to enter the password (4 digits).

- When shipped from the factory, password is “7890.”
- If you enter a wrong password, your setting will be canceled.

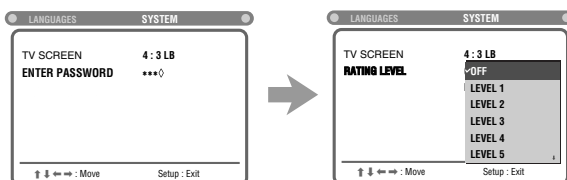

### 6 Press ▼ (or ▲) to select (highlight) the level you want, then press ENTER.

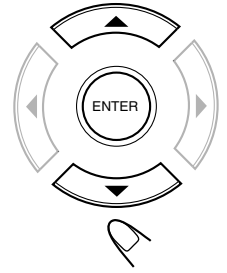

### To erase the Setup menu

Press SETUP again.



### To change the password

#### 1 Repeat steps 1 to 5 of “Setting the Parental (Rating) Level” procedure.

#### 2 Press ▼ (or ▲) to select (highlight) “NEW PASSWORD,” then ENTER.

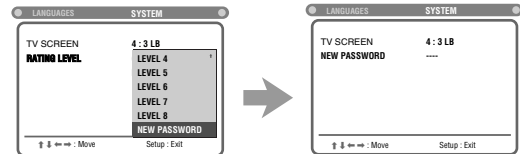
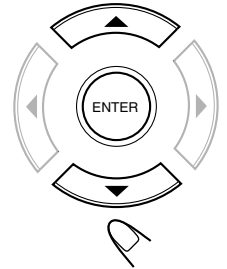

- If “NEW PASSWORD” is the last item listed on the pop-up window and is not shown, pressing ▼ repeatedly will show it in the pop-up window.

#### 3 Press the number buttons to enter a new password, then ENTER.

Your new password is now stored.

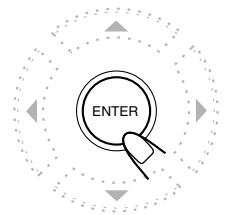

### To erase the Setup menu

Press SETUP again.



# Operating JVC's Components

You can use the remote control to operate not only this unit but also other JVC products.

- Refer also to the manuals supplied for the other products.
  - This remote control can operate a VCR whose remote control code is set to A code.
- To operate the other products, aim the remote control directly at the remote sensor on the target product.

## ❑ To operate a JVC's TV

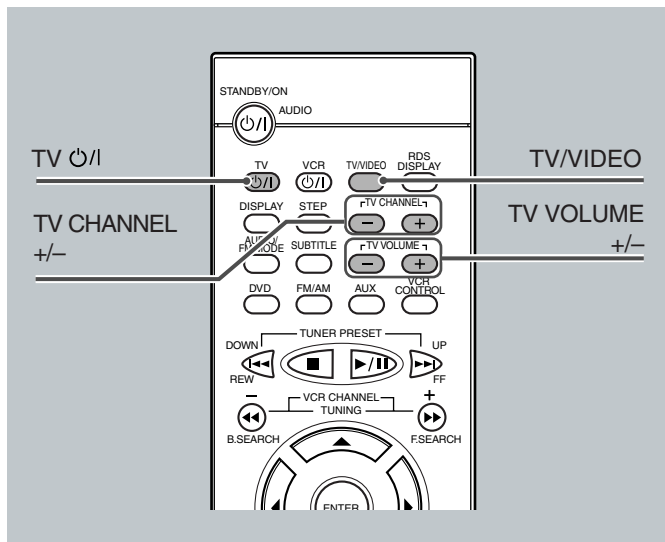

You can perform the following operations on the TV.

<b>TV ON/OFF</b>	: Turn on or off the TV.
<b>TV VOLUME +/-</b>	: Adjust the volume.
<b>TV/VIDEO</b>	: Set the input mode (either TV or VIDEO).
<b>TV CHANNEL +/-</b>	: Change the channels.

## ❑ To operate a JVC's VCR

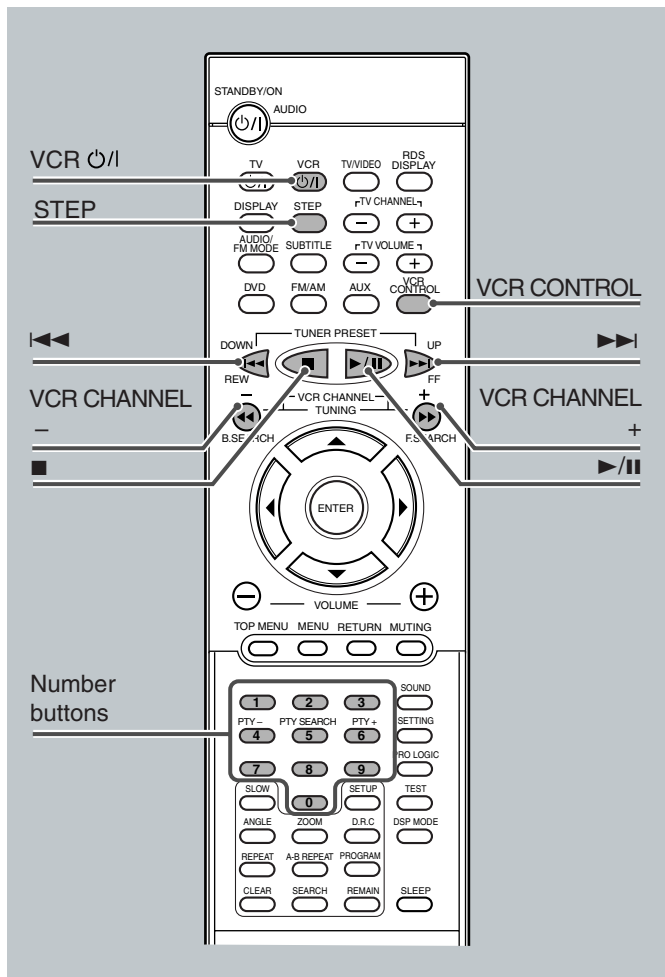

After pressing **VCR CONTROL** on the remote control, you can perform the following operations on the VCR.



<b>VCR ON/OFF</b>	: Turn on or off the VCR.
<b>VCR CHANNEL +/-</b>	: Change the channels.
<b>1 - 9, 0</b>	: Select TV channel on the VCR.
<b>▶/  </b>	: Start playback.
<b>■</b>	: Stop playback.
<b>STEP</b>	: Pause playback. To release it, press <b>▶/  </b> .
<b>FF (▶▶)</b>	: Fast-wind a tape.
<b>REW (◀◀)</b>	: Rewind a tape.

After operating the VCR, press **DVD** or **FM/AM**.



### **IMPORTANT:**

When you press **VCR CONTROL**, some buttons on the remote control cannot work for operating the system.

To operate the system, press **DVD** or **FM/AM**.

# Operating Other Manufacturers' TV

You can use the remote control to operate other manufacturers' TV.

- Refer also to the manuals supplied for the other products.
- To operate the other products, aim the remote control directly at the remote sensor on the target product.

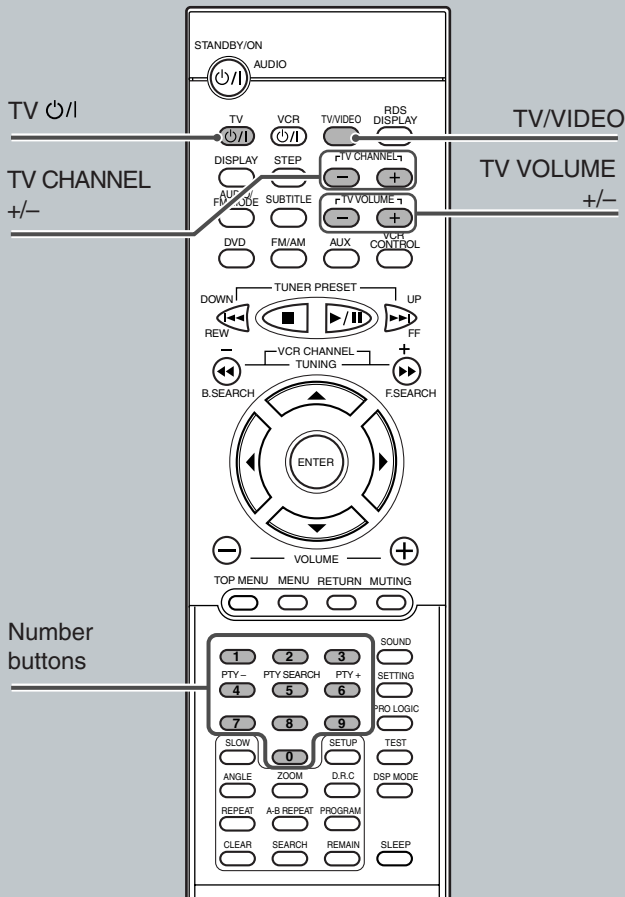

## □ To change the transmittable signals for operating a TV

1. Press and hold TV ON/OFF.
2. Enter manufacturer's code using buttons 1-9, and 0.
3. Release TV ON/OFF.

Now, you can perform the following operations on the TV.

<b>TV ON/OFF</b>	: Turn on or off the TV.
<b>TV VOLUME +/-</b>	: Adjust the volume.
<b>TV/VIDEO</b>	: Set the input mode (either TV or VIDEO)
<b>TV CHANNEL +/-</b>	: Change the channels.

4. Try to operate your TV by pressing TV ON/OFF.  
When your TV turns on or off, you have entered the correct code.

If there are more than one code listed for your brand of TV, try each one until the correct one is entered.

Manufacturers' codes for TV

Manufacturer	Codes
JVC	01
Akai	12
Fisher	12
Grundig	09, 17, 21
Hitachi	11, 13, 14, 24
Mitsubishi	02, 16
Nokia	23
Nordmende	13, 14, 24
Panasonic	08, 23 - 27
Philips	02, 20, 22
Saba	13, 14, 22 - 24
Samsung	03 - 06, 32
Sanyo	12, 16
Schneider	12
Sharp	10, 31
Sony	15, 16
Telefunken	14, 24, 28
Thomson	13, 14, 24, 33, 34
Toshiba	07, 16 - 19, 21

Manufacturers' codes are subject to change without notice. If they are changed, this remote control cannot operate the equipment.

# Maintenance

To get the best performance of the unit, keep your discs and mechanism clean.

## General Notes

In general, you will have the best performance by keeping your discs, and the mechanism clean.

- Store discs in their cases, and keep them in cabinets or on shelves.
- Keep the disc tray closed when not in use.

## Handling Discs



- Remove the disc from its case by holding it at the edge while pressing the center hole lightly.
- Do not touch the shiny surface of the disc, or bend the disc.
- Put the disc back in its case after use to prevent warping.

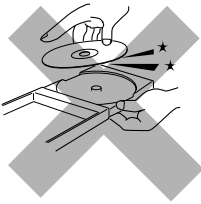

- Be careful not to scratch the surface of the disc when placing it back in its case.
- Avoid exposure to direct sunlight, temperature extremes, and moisture.



### To clean the disc

Wipe the disc with a soft cloth in a straight line from center to edge.

**DO NOT use any solvent—such as conventional record cleaner, spray, thinner, or benzine—to clean the disc.**

## Cleaning the unit

### • Stains on the unit

Should be wiped off with a soft cloth. If the unit is heavily stained, wipe it with a cloth soaked in water-diluted neutral detergent and wrung well, then wipe clean with a dry cloth.

### • Since the unit may deteriorate in quality, become damaged or get its paint peeled off, be careful about the following.

- DO NOT wipe it with a hard cloth.
- DO NOT wipe it strong.
- DO NOT wipe it with thinner or benzine.
- DO NOT apply any volatile substance such as insecticides to it.
- DO NOT allow any rubber or plastic to remain in contact with it for a long time.

# Troubleshooting

Use this chart to help you solve daily operational problems. If there is any problem you cannot solve, contact your JVC service center.

PROBLEM	POSSIBLE CAUSE	SOLUTION
Power does not come on.	The power cord is not plugged in.	Insert the plug into the socket.
The remote control does not work.	<ul style="list-style-type: none"> <li>• It is too far from the center unit, or is not facing the center unit.</li> <li>• There is something obstructing the remote sensor.</li> <li>• <b>The VCR CONTROL button has been pressed.</b></li> <li>• The battery is flat.</li> <li>• The battery has been inserted the wrong way round (+/-).</li> <li>• Sunlight is falling directly on the detector.</li> </ul>	<ul style="list-style-type: none"> <li>• Come close to the center unit.</li> <li>• Avoid any obstacles.</li> <li>• <b>Press DVD or FM/AM to operate the system. (See page 54.)</b></li> <li>• Replace the battery.</li> <li>• Insert the battery correctly.</li> <li>• Shade the remote control from direct sunlight.</li> </ul>
No sound.	<ul style="list-style-type: none"> <li>• There is a short in the speaker cord.</li> <li>• The audio cord is not connected properly.</li> <li>• An incorrect source has been selected.</li> <li>• Muting is on.</li> <li>• The disc is copy-protected CD.</li> </ul>	<ul style="list-style-type: none"> <li>• Reconnect the speaker cord.</li> <li>• Connect the cord properly. (See page 8.)</li> <li>• Select the correct source. (See pages 10 to 15.)</li> <li>• Press MUTING to cancel muting.</li> <li>• Replace the disc.</li> </ul>
Sound is emitted from only one speaker.	<ul style="list-style-type: none"> <li>• The speaker cord is not connected correctly.</li> <li>• Left-right balance is incorrect.</li> </ul>	<ul style="list-style-type: none"> <li>• Connect the cord properly. (See page 7.)</li> <li>• Adjust balance. (See pages 20 to 24.)</li> </ul>
No video.	<ul style="list-style-type: none"> <li>• The video cord is not connected properly.</li> <li>• TV input selection is incorrect.</li> </ul>	<ul style="list-style-type: none"> <li>• Connect the cord properly. (See page 9.)</li> <li>• Select the correct input.</li> </ul>
A disc cannot be played.	<ul style="list-style-type: none"> <li>• The system and disc region code numbers are incompatible.</li> <li>• The disc causes the parental (rating) error.</li> </ul>	<ul style="list-style-type: none"> <li>• Replace the disc. (See page 25.)</li> <li>• Enter password to change the parental (rating) level. (See page 53.)</li> </ul>
“WRONG DISC FORMAT” appears on the TV screen.	<ul style="list-style-type: none"> <li>• The CD-R/CD-RW does not contain any MP3 files.</li> </ul>	<ul style="list-style-type: none"> <li>• Replace the disc.</li> </ul>
Video and audio are distorted.	<ul style="list-style-type: none"> <li>• The disc is dirty.</li> <li>• A VCR is connected between the center unit and the TV.</li> </ul>	<ul style="list-style-type: none"> <li>• Clean the disc.</li> <li>• Connect the center unit and TV directly.</li> </ul>
The edge is missing on the video image.	<ul style="list-style-type: none"> <li>• Initial setup (TV screen size) was incorrect.</li> </ul>	<ul style="list-style-type: none"> <li>• Set TV screen size correctly. (See pages 51 and 52.)</li> </ul>
Continuous static during FM broadcasts.	<ul style="list-style-type: none"> <li>• The received signal is too weak.</li> <li>• The station is too far away.</li> <li>• The antenna is not connected correctly.</li> </ul>	<ul style="list-style-type: none"> <li>• Connect an external FM antenna (see page 5), or contact your dealer.</li> <li>• Select another station.</li> <li>• Check the connection. (See page 5.)</li> </ul>
The system does not work correctly.	<ul style="list-style-type: none"> <li>• Lightning or electronic noise interferes with operation of the microcomputer.</li> <li>• Immediately after beginning to heat the room, the unit was moved to a cold location causing condensation to form inside.</li> </ul>	<ul style="list-style-type: none"> <li>• Switch power off, and remove and re-insert the power plug in the socket.</li> <li>• Switch power off and leave the unit a few hours before switching power on again.</li> </ul>
The VCR cannot be operated using this remote control.	<ul style="list-style-type: none"> <li>• The remote control is not set for VCR operations.</li> <li>• The VCR is not a JVC's product.</li> </ul>	<ul style="list-style-type: none"> <li>• Press VCR CONTROL to operate the VCR. (See page 54.)</li> <li>• This remote control can operate a JVC's VCR whose remote control code is set to A code.</li> </ul>

# Specifications

## Center unit (XV-THA30R)

### Amplifier section

Front/Center/Rear:

**25 watts per channel, min. RMS at 6 ohms as 1 kHz, with no more than 10 % total harmonic distortion.**

Subwoofer:

**110 watts, min. RMS at 4 ohms as 100 Hz, with no more than 10 % total harmonic distortion.**

### Audio section

Audio input sensitivity/Impedance (at 1 kHz)

Analog input:

AUX ("AUX IN"): 500 mV/47 k $\Omega$

### Video section

Color System: PAL

Horizontal Resolution: 480 lines

Signal-to-Noise Ratio: 68 dB

Output Level

VIDEO(Composite): 1.0 V(p-p)/75  $\Omega$

S-VIDEO(Y): 1.0 V(p-p)/75  $\Omega$

(C): 0.286 V(p-p)/75  $\Omega$

### Tuner section

Tuning Range FM : 87.5 MHz – 108.0 MHz  
AM : 522 kHz – 1 629 kHz

Usable Sensitivity FM: 8.0 dBf (0.9  $\mu$ V/75  $\Omega$ )  
AM loop antenna: 650  $\mu$ V/m

### General

Readable Discs: DVD VIDEO, Video CD,  
Super Video CD, Audio CD,  
CD-R/RW (Audio CD, Video CD,  
Super Video CD, MP3 disc),  
DVD-R (Video format)

Power Requirements: AC 230 V $\sim$ , 50 Hz

Power Consumption: 120 W (at operation)  
2 W (in standby mode)

Dimensions (W  $\times$  H  $\times$  D): 350 mm  $\times$  80 mm  $\times$  365 mm

Mass: 6.5 kg

## Subwoofer (SP-WA30)

Speaker: 20 cm  
Bass-reflex, Magnetically Shielded

Power Handling Capacity: 110 W

Impedance: 4  $\Omega$  (min)

Frequency Range: 25 Hz to 200 Hz

Dimensions (W  $\times$  H  $\times$  D): 249 mm  $\times$  404 mm  $\times$  335 mm

Mass: 6.5 kg (except cords)

## Satellite Speakers (SP-XA30)

Speakers: 8 cm  
Bass-reflex, Magnetically Shielded

Power Handling Capacity: 35 W

Impedance: 6  $\Omega$  (min)

Frequency Range: 90 Hz to 20 kHz

Length of cords: 6 m

Dimensions (W  $\times$  H  $\times$  D): 105 mm  $\times$  119 mm  $\times$  126 mm

Mass: 600 g (except cords)

## Rear Satellite Speakers (SP-XSA30)

Speakers: 8 cm  
Bass-reflex, Magnetically Shielded

Power Handling Capacity: 35 W

Impedance: 6  $\Omega$  (min)

Frequency Range: 90 Hz to 20 kHz

Length of cords: 10 m

Dimensions (W  $\times$  H  $\times$  D): 105 mm  $\times$  119 mm  $\times$  126 mm

Mass: 600 g (except cords)

Designs & specifications are subject to change without notice.



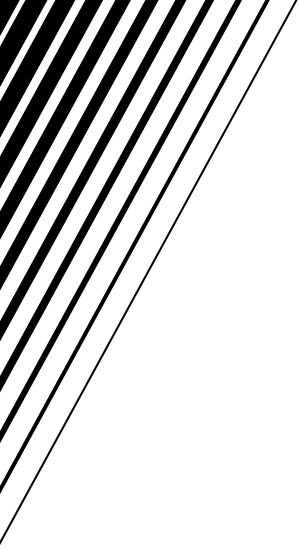

**JVC**  
VICTOR COMPANY OF JAPAN, LIMITED