



# OWNER'S INSTRUCTIONS

Indoor Unit  
AS070VE/D/B  
AS090VE/D  
AS120VE/D  
AS071VE/D/B  
AS091VE/D  
AS121VE/D

Indoor Unit  
AS07A1(A2)VE/B  
AS09A1(A2)VE/B  
AS12A1(A2)VE/B  
SC09ZV  
SC12ZV  
AS07A1(A2)VA  
AS09A1(A2)VA  
AS09D1(D2)VD  
AS12D1(D2)VD

## SPLIT-TYPE ROOM AIR CONDITIONER (Cool)

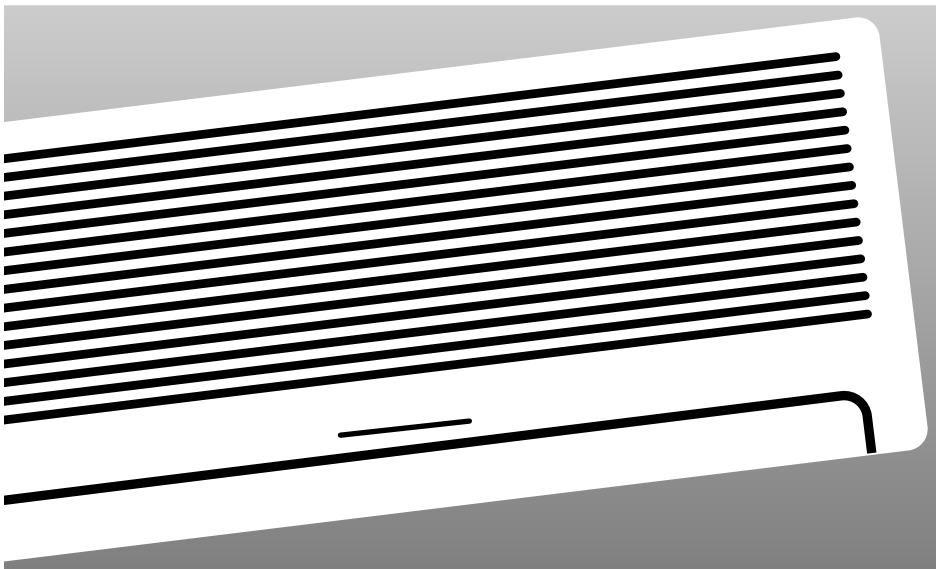

## Safety Precautions

The following safety precautions must be taken when using your air conditioner.

- 1 *Make sure that the indoor unit is correctly ventilated at all times; do NOT place clothing or other materials over it.*
- 2 *NEVER spill liquid of any kind into the indoor unit. Should this happen, switch off the breaker used for your air conditioner and contact your installation specialist.*
- 3 *Do NOT insert anything between the air flow blades, as the inner fan may be damaged and you may be hurt. Keep children away from the indoor unit.*
- 4 *Do NOT place any obstacles in front of the outdoor unit.*
- 5 *If the remote control will not be used for a long time, remove the batteries.*
- 6 *Users of this product are cautioned not to attempt repair of this product at their own discretion. Instead, they are requested to directly contact a designated service center or the outlet at which the product was purchased.*
- 7 *If the supply cord is damaged, it must be replaced by a special cord or assembly available from the manufacturer or its service agent.*
- 8 *This device must be installed according to the national electrical rules.*
- 9 *Before throwing out the device, it is necessary to pull back the battery cells and get rid of them safely.*

# Contents

---

◆ PREPARING YOUR AIR CONDITIONER	
■ Safety Precautions .....	2
■ View of the Indoor Unit.....	4
■ View of the Outdoor Unit.....	4
■ Remote Control - Buttons and Display.....	5
■ Getting Started .....	6
■ Installing the Remote Control Holder on the Wall .....	7
■ Inserting the Remote Control Batteries.....	7
■ Setting the Time .....	8
◆ OPERATING YOUR AIR CONDITIONER	
■ Selecting the Automatic Operating Mode.....	9
■ Cooling Your Room.....	10
■ Changing the Room Temperature Quickly .....	11
■ Removing Excess Humidity.....	12
■ Airing Your Room.....	13
■ Adjusting the Air Flow Direction Vertically.....	14
■ Adjusting the Air Flow Direction Horizontally .....	14
◆ PROGRAMMING YOUR AIR CONDITIONER	
■ Switching the Unit On and Off Automatically (On/Off Timer) .....	15
■ Setting the Sleep Timer .....	16
■ Setting the Quick Timer .....	16
■ Cancelling the On/Off Timer .....	17
■ Cancelling the Sleep Timer .....	17
■ Cancelling the Quick Timer .....	17
◆ RECOMMENDATIONS FOR USE	
■ Operating Recommendation .....	18
■ Temperature and Humidity Ranges.....	19
■ Cleaning Your Air Conditioner .....	19
■ Solving Common Problems.....	20
■ Operating Your Air Conditioner Without the Remote Control .....	21
■ Installing a Filter (Option) .....	22
◆ TECHNICAL SPECIFICATIONS	

## View of the Indoor Unit

\* The design and shape are subject to change according to the model.

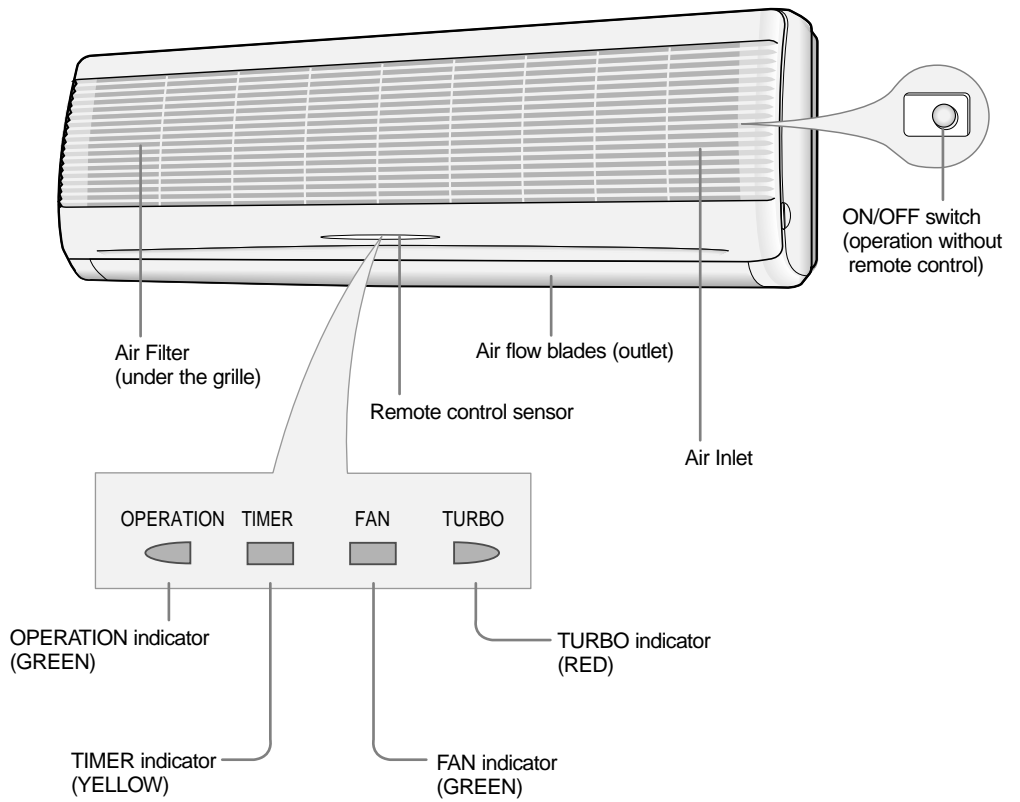

## View of the Outdoor Unit

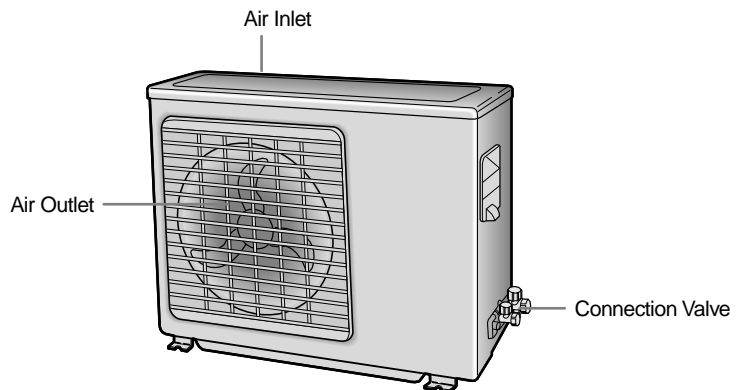

# Remote control - Buttons and Display



## Getting Started

You have just purchased a split-type room air conditioner and it has been installed by your installation specialist.

Your Owner's Instructions contain much valuable information on using your air conditioner. Please take the time to read them as they will help you take full advantage of the unit's features.

The booklet is organized as follows.

- ◆ The following figures are shown on pages 4 and 5:
  - Indoor and outdoor units
  - Remote control (buttons and display)They will help you find the buttons and understand the symbols displayed.
- ◆ In the main part of the document, you will find a series of step-by-step procedures for each function available.

The illustrations in the step-by-step procedures use three different symbols:

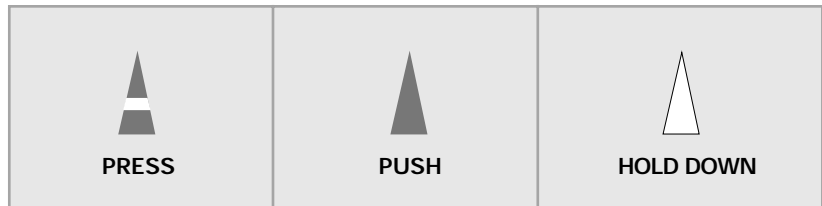

## Installing the Remote Control Holder on the Wall

The remote control is supplied with a plastic holder that can be fitted to the wall to hold the remote control when you are not using it. To attach the holder to the wall, proceed as follows.

- 1 With a pencil, mark the positions of the two holes on the wall where the holder is to be installed.
- 2 Drill the two holes and insert plugs as required for the type of wall on which the holder is being installed.
- 3 Screw the holder into position.

**Result:** You can now slide the remote control in and out of the holder as required.

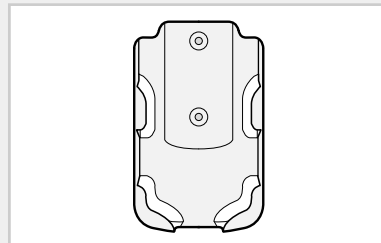

## Inserting the Remote Control Batteries

You must insert or replace the remote control batteries when:

- ◆ You purchase the air conditioner
- ◆ The remote control does not work correctly

**Note** Use two LR03 1.5 V batteries. Do not use old batteries or different kinds of batteries together. Batteries may be completely discharged after 12 months, even if they have not actually been used.

- 1 Slide the remote control out of its holder.
- 2 Push the battery cover on the rear of the remote control with your thumb in the direction of the arrow and remove it.
- 3 Insert the two batteries, taking care to respect the polarities:
  - ◆ + on the battery with + on the remote control
  - ◆ - on the battery with - on the remote control
- 4 Close the cover by sliding it back until it clicks into place.

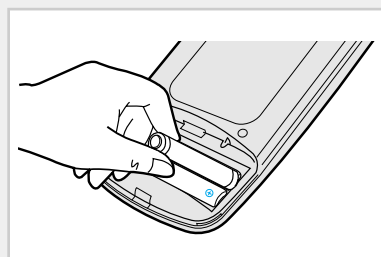

## Setting the Time

Your air conditioner contains a clock used to start and stop the unit automatically at a given time.

You must set the time when you:

- ◆ Purchase the air conditioner
- ◆ Replace the batteries

**Note** Be sure to reset the time when you change clocks from standard daylight savings time and vice versa.

### Setting the Time for the First Time

1 Insert the batteries.

- ◆ Push the battery cover on the rear of the remote control with your thumb and remove it.

**Result:** The clock starts.

2 Using a small pointed tool (ball-point pen for example), Press the  button.





**Result:** The AM indication flashes.

3 To set the current time, press the  or  buttons under the cover on the remote control.

**To...**

- Increase the time in one-minute intervals
- Increase the time in ten-minute intervals
- Decrease the time in one-minute intervals
- Decrease the time in ten-minute intervals

**Then...**

- Press the  button.
- Hold down the  button.
- Press the  button.
- Hold down the  button.

**Result:** AM or PM is displayed to indicate whether the setting corresponds to a time before or after midday.

4 When you are satisfied with your setting, confirm the time. To do so: using a small pointed tool (ball-point pen for example), press the  button.

- Result:**
- ◆ The AM or PM indication stops flashing.
  - ◆ The clock starts.

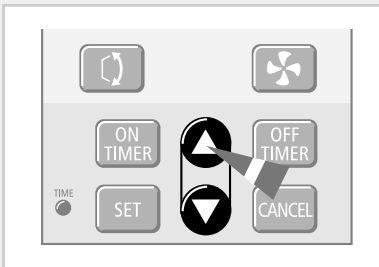
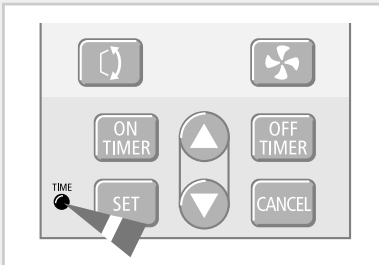

### Resetting the Time

If you have already set the time but wish to change it, proceed as follow.

1 Using a small pointed tool (ball-point pen for example), press the  button under the remote control flap.

**Result:** The AM or PM indication flashes.

2 Set the time, following the instructions in Step 3 in the procedure above.

3 When you are satisfied with your setting, confirm the time. To do so, press the  button, using a small pointed tool (ball-point pen for example).

- Result:**
- ◆ The AM or PM indication stops flashing.
  - ◆ The clock starts.



## Selecting the Automatic Operating Mode



You can start the air conditioner in Automatic mode from your remote control. In the Automatic mode, the standard temperature and the optimum fan speed is selected automatically. You can adjust the standard temperature but not the fan speed.

1 If necessary, press the  (On/Off) button.

- Result:**
- ◆ The OPERATION indicator on the indoor unit comes on.
  - ◆ The air conditioner starts up in the mode selected when the unit was last used.
  - ◆ The indoor unit beeps.



**IMPORTANT** The air conditioner is fitted with a protection mechanism to prevent the unit from being damaged when it is started immediately after being:





- ◆ Plugged in
  - ◆ Stopped
- It will start up normally after a three-minute.

2 If the  indication is not displayed at the top of the remote control, press the  button on the remote control one or more times until it appears.

- Result:**
- ◆ The indoor unit beeps each time you press .
  - ◆ The air conditioner starts up in AUTO mode.

**Note** You can change modes at any time.

3 To adjust the standard temperature (The air conditioner automatically set the standard temperature by the current room temperature.), press the  or  buttons one or more times.

SET TEMP.	SET TEMP.	-	SET TEMP.	SET TEMP.
-2°C	-1°C	Standard temperature	+1°C	+2°C
(  )	(  )	(  )	(  )	(  )
< When you feel hot >			< When you feel chilly >	

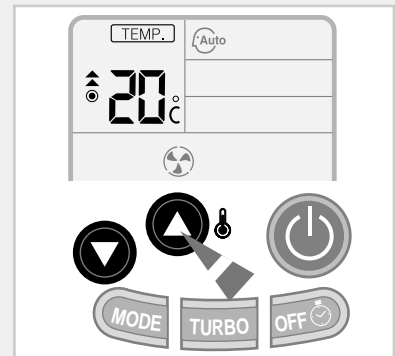
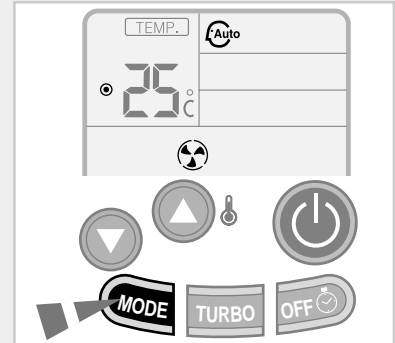
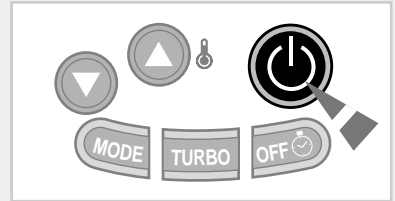

## Cooling Your Room

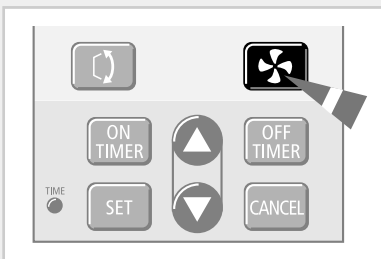
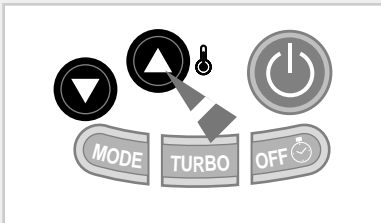
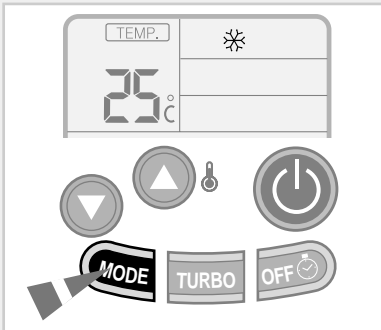
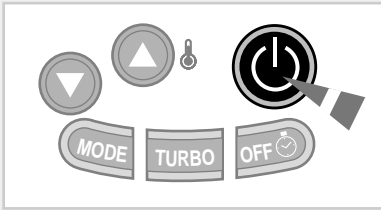

You must select the Cool mode if you wish to adjust the:

- ◆ Cooling temperature
- ◆ Fan speed when cooling

1 If necessary, press the (On/Off) button.

- Result:
- ◆ The OPERATION indicator on the indoor unit comes on.
  - ◆ The air conditioner starts up in the mode selected when the unit was last used.
  - ◆ The indoor unit beeps.

**IMPORTANT** The air conditioner is fitted with a protection mechanism to prevent the unit from being damaged when it is started immediately after being:

- ◆ Plugged in
- ◆ Stopped

It will start up normally after a three-minute.

2 If the indication is not displayed at the top of the remote control, press the button on the remote control one or more times until it appears.

- Result:
- ◆ The indoor unit beeps each time you press .
  - ◆ The air conditioner starts up in Cool mode.

**Note** You can change modes at any time.

3 To adjust the temperature, press the or buttons one or more times until the required temperature is displayed. Possible temperatures are between 18°C and 30°C inclusive.

- Result:
- ◆ Each time you press or :
    - The temperature is adjusted by 1°C
    - The indoor unit beeps
  - ◆ The air conditioner starts cooling, provided that the room temperature is higher than the selected temperature; the fan will, however, operate.

4 Select the fan speed by pressing the button one or more times until the required setting is displayed:

- Low
- Medium
- High
- Automatic

Result: Each time you press , the indoor unit beeps.

5 To control the direction of the air flow, refer to page 14.

## Changing the Room Temperature Quickly

The Turbo cooling function is used to cool your room as quickly as possible.

**Example:** You have just come home and find that the room is very hot. You wish to cool it down as quickly as possible.

The Turbo function operates for 30 minutes with the maximum settings before returning automatically to the mode and temperature previously selected.





1 If necessary, press the  (On/Off) button.

**Result:**





- ◆ The OPERATION indicator on the indoor unit comes on.
- ◆ The air conditioner starts up in the mode selected when the unit was last used.
- ◆ The indoor unit beeps.

2 Press the  button.

**Result:**

- ◆ The temperature and fan settings are adjusted automatically.
- ◆ The TURBO indicator on the indoor unit lights up.
- ◆ The air conditioner cool the room as quickly as possible.
- ◆ After 30 minutes, the air conditioner is reset automatically to the previous mode, temperature and fan settings.  
but, if you press the  button in  or  mode that is changed with  mode automatically.

3 If you wish to stop the Turbo function before the end of the 30-minute period, press the  button again.

**Result:** The air conditioner is reset automatically to the previous mode, temperature and fan settings.  
but, if you press the  button in  or  mode that is changed with  mode automatically.

4 To control the direction of the air flow, refer to page 14.

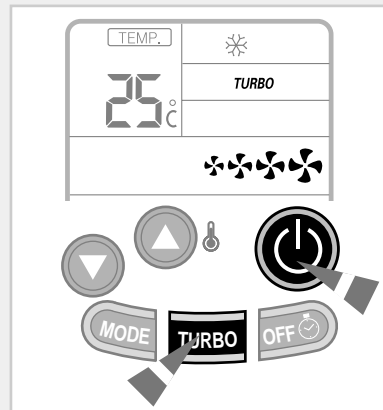

## Removing Excess Humidity

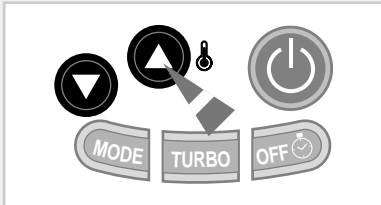
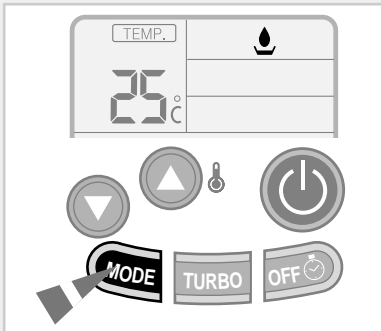
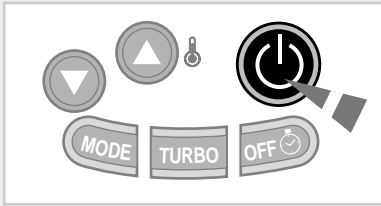

If the atmosphere in your room is very humid or damp, you can remove excess humidity without lowering the room temperature too much.

- 1 If necessary, press the  (On/Off) button.



**Result:**

- ◆ The OPERATION indicator on the indoor unit comes on.
- ◆ The air conditioner starts up in the mode selected when the unit was last used.
- ◆ The indoor unit beeps.

**IMPORTANT** The air conditioner is fitted with a protection mechanism to prevent the unit from being damaged when it is started immediately after being:

- ◆ Plugged in
- ◆ Stopped



It will start up normally after a three-minute.

- 2 If the  indication is not displayed at the top of the remote control, press the  button on the remote control one or more times until it appears.



**Result:**

- ◆ The indoor unit beeps each time you press .
- ◆ The air conditioner starts up in Dry mode.

**Note** You can change modes at any time.

- 3 To adjust the temperature, press the  or  buttons one or more times until the required temperature is displayed. Possible temperatures are between 18°C and 30°C inclusive.

**Result:**

- ◆ Each time you press  or :
  - The temperature is adjusted by 1°C
  - The indoor unit beeps
- ◆ The air conditioner starts removing the excess humidity; the quantity of air is adjusted automatically.



- 4 To control the direction of the air flow, refer to page 14.

# Airing Your Room

If the atmosphere in your room is stale, you can air the room using the Fan feature.

1 If necessary, press the  (On/Off) button.



- Result:**
- ◆ The OPERATION indicator on the indoor unit comes on.
  - ◆ The air conditioner starts up in the mode selected when the unit was last used.
  - ◆ The indoor unit beeps.

2 If the  indication is not displayed at the top of the remote control, press the  button on the remote control one or more times until it appears.

- Result:**
- ◆ The indoor unit beeps each time you press .
  - ◆ The FAN indicator on the indoor unit lights up.
  - ◆ The air conditioner starts up in Fan mode.
  - ◆ The temperature is set automatically.

**Note** You can change modes at any time.

3 Select the fan speed by pressing the  button one or more times until the required setting is displayed:

-  Low
-  Medium
-  High

**Result:** Each time you press , the indoor unit beeps.

4 To control the direction of the air flow, refer to page 14.

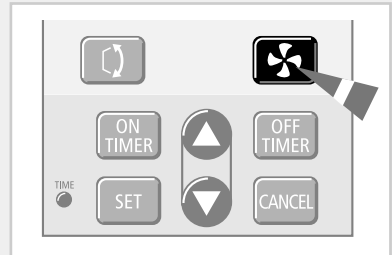
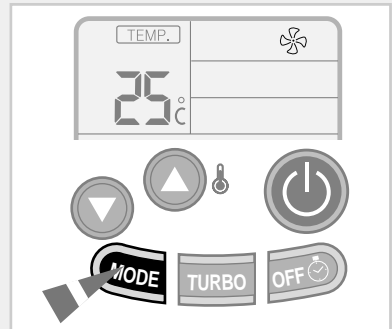
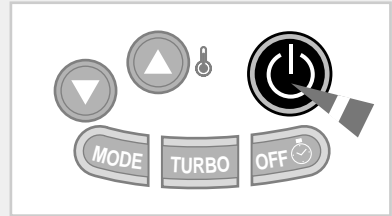

## Adjusting the Air Flow Direction Vertically

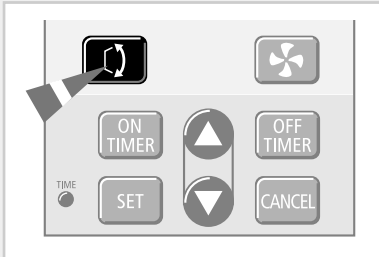

Depending on the position of the indoor unit on the wall of your room, you can adjust the position of the outer air flow blade on the bottom of the unit, thus increasing the efficiency of the air conditioner.

- 1 Press the  button under the remote control flap one or more times as required.

Result: The outer blade is adjusted vertically.

<b>RECOMMENDATION</b>	<b>When...</b>	<b>Adjust the blade to face...</b>
	Cooling	Upwards.

- 2 If you want the blade to move up and down automatically when the air conditioner is operating, press the  button.

Result: The blade move up and down, around the base position set.



- 3 To stop the blade moving up and down, press the  button again.

<b>Note</b>	<i>If you switch the air conditioner...</i>	<i>Then the blade is...</i>
	<i>Off</i>	<i>Closed completely.</i>
	<i>On again</i>	<i>Reset to the position that you previously selected.</i>

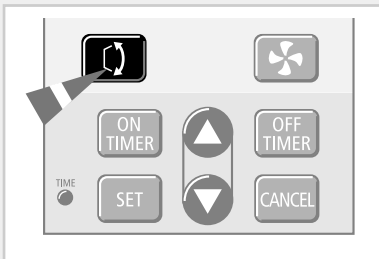
## Adjusting the Air Flow Direction Horizontally



There are two sets of inner air flow blades. Just as the outer air flow blade can be adjusted vertically, the inner blades can be adjusted horizontally.

- 1 Open the air flow blade along the bottom of the indoor unit, by pressing the  button.
- 2 To stop the blade moving up and down, press the  button again.
- 3 Adjust each set of inner blades to the required position, by pushing or pulling them sideways.

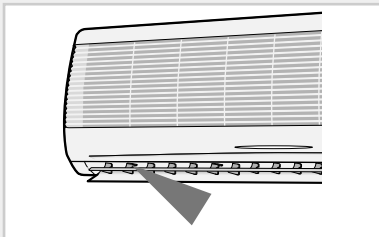

## Switching the Unit On and Off Automatically (On/Off Timer)

You can set the timer to switch the air conditioner on and/or off automatically at given times.

**Example:** You wish to start cooling your room before you return from work; you decide to:



- ◆ Switch the air conditioner on at 5:30 p.m.
- ◆ Switch it off at 11:30 p.m.

You can set:

- ◆ The switch-on time only
- ◆ The switch-off time only
- ◆ Both the switch-on and switch-off times

**IMPORTANT** Check that the current time is correct before setting the timer; if it is not correct, refer to page 8 for details on how to set it.

1 If necessary, press the  (On/Off) button.



2 Select the required mode by pressing the  button on the remote control one or more times until the appropriate indication appears (in the above example, .

3 Press the  button under the cover on the remote control.

**Result:**

- ◆ The  indication flashes.
- ◆ The current preset time is displayed.





**Note** If you do not press a button within a few seconds, the Timer function is cancelled and you must press the  button again.

4 To set the switch-on time, press the  or  buttons.

**To...**

Increase the time in ten-minute intervals  
 Increase the time in one-hour intervals  
 Decrease the time in ten-minute intervals  
 Decrease the time in one-hour intervals

**Then...**

Press the  button.  
 Hold down the  button.  
 Press the  button.  
 Hold down the  button.

**Result:** AM or PM is displayed to indicate whether the setting corresponds to a time before or after midday.

5 When you are satisfied with the switch-on time, press .

**Result:**

- ◆ The indoor unit beeps.
- ◆ The TIMER indicator on the indoor unit lights up yellow.

**Note** If not necessary to operate the air conditioner until the set up time for starting, press  (On/Off) button off. The air conditioner will start up automatically when the switch-on time is reached.

6 To set the switch-off time, press the  button.

**Result:**

- ◆ The  indication flashes.
- ◆ The current preset time is displayed.

7 Set the switch-off time, following the instructions in Step 4.

8 When you are satisfied with the switch-off time, press .

**Result:**

- ◆ The indoor unit beeps.
- ◆ The TIMER indicator on the indoor unit lights up yellow.
- ◆ The air conditioner will switch off automatically when the switch-off time is reached.

**Note** If you wish to cancel the timer, refer to page 17.

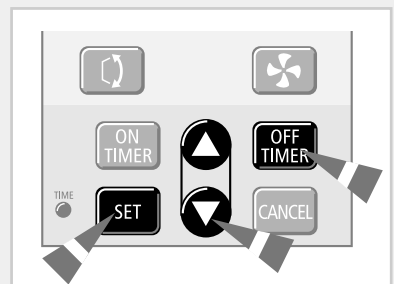
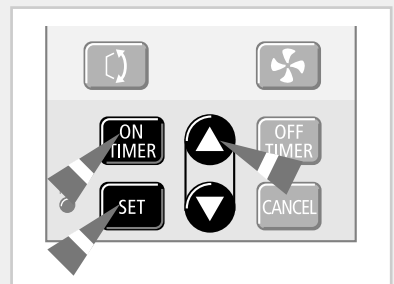
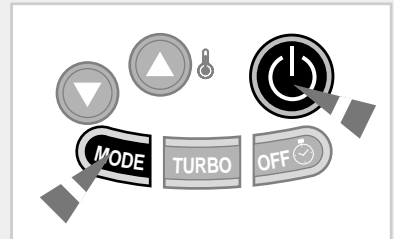

## Setting the Sleep Timer

The Sleep Timer can be used when you are cooling your room to switch the air conditioner off automatically after a period of six hours.

**Note** If you wish to switch the unit off at a specific time, refer to page 15.

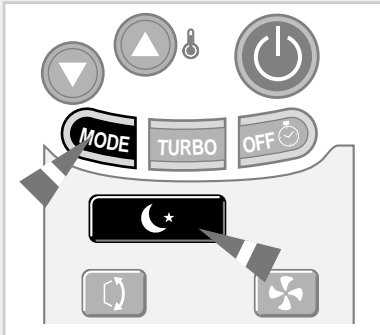

- 1 If the ☀ indication is not displayed at the top of the remote control, press the **MODE** button on the remote control one or more times until it appears.
- 2 Press the **Sleep Timer** button .  
**Result:**
  - ◆ The indoor unit beeps.
  - ◆ The ☾★ indication is displayed.
  - ◆ The air conditioner will be controlled as indicated in the illustrations below.

**Cooling** The temperature is increased by 1°C every hour. When it has been increased by 2°C (after two hours), the temperature is maintained for four hours.

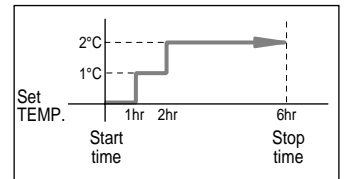

## Setting the Quick Timer

The Quick Timer enables you to set the air conditioner to switch off automatically after a given period of time, by pressing one single button. The unit can be switched off automatically after 30 minutes, one hour, two hours, three hours or five hours.

**Note** If you wish to switch the unit off at a specific time, refer to page 15.



- 1 If necessary, switch the air conditioner on and select the required mode.
- 2 Press **Quick Timer** one or more times until the correct period is displayed:

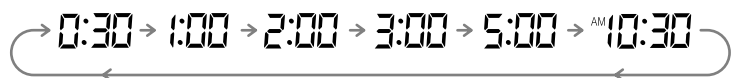





**Result:**

- ◆ The TIMER indicator lights up yellow.
- ◆ The air conditioner will switch off automatically when the counter displayed on the remote control reaches 0:00.



## Cancelling the On/Off Timer

If you no longer wish to use the On/Off Timer that you have set, you can cancel it at any time.

- |                           |  |
|---------------------------|--|
| <b>1 To cancel the...</b> | <b>Then press...</b>   |
| Switch-on timer           |  .                                      |
|                           | <b>Result:</b> The  indication flashes. |
| Switch-off timer          |  .                                      |
|                           | <b>Result:</b> The  indication flashes. |

- 2** Press the  button.
- Result:**
- ◆ The indoor unit beeps.
  - ◆ The TIMER indicator on the indoor unit switches off if no other timer is currently set.
  - ◆ The air conditioner operates normally.

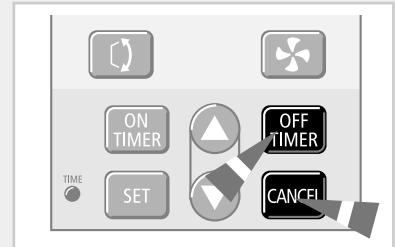
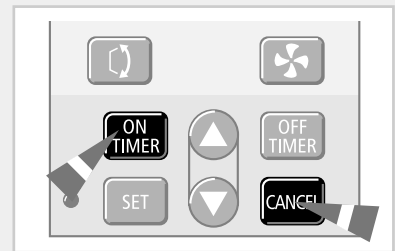

## Cancelling the Sleep Timer

If you no longer wish to use the Sleep Timer that you have set, you can cancel it at any time.

Press the  button.

- Result:**
- ◆ The indoor unit beeps.
  - ◆ The  indication is no longer displayed.
  - ◆ The air conditioner operates normally.

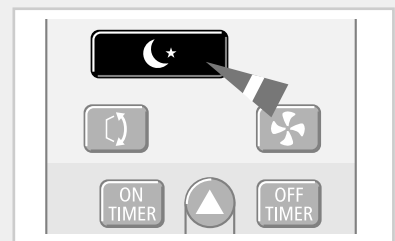

## Cancelling the Quick Timer

If you no longer wish to use the Quick Timer that you have set, you can cancel it at any time.

Press the  button one or more times until the current time indication is displayed.

- Result:**
- ◆ The indoor unit beeps each time you press .
  - ◆ The air conditioner operates normally.

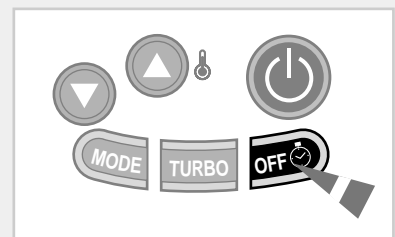

## Operating Recommendation

Here is a recommendation that you should follow when using your air conditioner.

Topic	Recommendation
Power failure	If a power failure occurs when the air conditioner is operating, the unit is switched off. When the power returns, <hr/> <p>AS070VE/D/B      you must press AS090VE/D       (On/Off) to restart it, AS120VE/D AS071VE/D/B AS091VE/D AS121VE/D AS07A1VE/B/A AS09A1VE/B/A AS12A1VE/B SC09ZV SC12ZV AS09D1VD AS12D1VD</p> <hr/> <p>AS07A2VE/B/A      the air conditioner starts up AS09A2VE/B/A      again automatically AS12A2VE/B AS09D2VD AS12D2VD</p> <hr/>

## Temperature and Humidity Ranges

The following table indicates the temperature and humidity ranges within which the air conditioner can be used.

If the air conditioner is used at...	Then...
High temperatures	The automatic protection feature may be triggered and the air conditioner stopped.
Low temperatures	A water leakage or some other malfunction may happen if the heat exchanger freezes.
High humidity levels	Water may condense on and drip from the surface of the indoor unit if it is used for long periods.

Mode	Outdoor Temperature	Indoor Temperature	Indoor Humidity
Cooling	21°C to 43°C approx.	18°C to 32°C approx.	80% or less
Drying	18°C to 43°C approx.	18°C to 32°C approx.	-

\* If the cooling operation is used at over 33°C(indoor temperature) then, does not a full capacity.

## Cleaning Your Air Conditioner

To get the best possible use out of your air conditioner, you must clean it regularly to remove the dust that accumulates on the air filter.

**IMPORTANT** Before cleaning your air conditioner, ensure that you have switched off the breaker used for the unit.

- 1 Open the front grille by pulling on the tabs on the lower right and left sides of the indoor unit.
- 2 Lift out the bottom edge of the air filters and pull down to release them.
- 3 Remove all dust on the air filters with a vacuum cleaner or brush.
- 4 When you have finished, insert the top part of the filters into their slot and push down on the bottom edge until they click into place.
- 5 Clean the front panel with a damp cloth and mild detergent (do NOT use benzene, solvents or other chemicals).





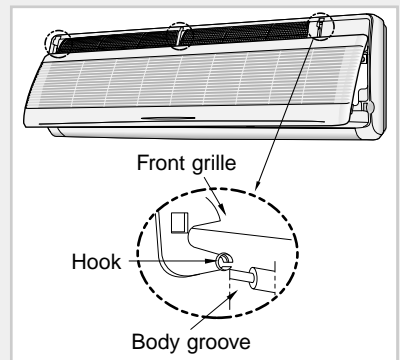
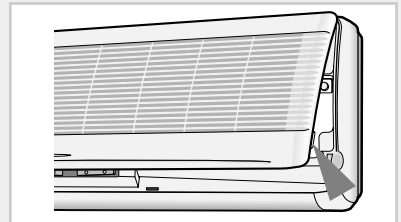





**Note**

- ◆ If you have not used the air conditioner for a long period of time, set the fan going for three to four hours to dry the inside of the air conditioner thoroughly.
- ◆ The removal of the front grille facilitates your cleaning the air conditioner. After opening the front grille, lift up to the max, push slightly to the left, and pull down to release them and vice versa.



## Solving Common Problems

Before contacting the after-sales service, perform the following simple checks. They may save you the time and expense of an unnecessary call.

Problem	Explanation/Solution
The air conditioner does not operate at all	<ul style="list-style-type: none"> <li>◆ Check that the breaker used for the air conditioner is switched on.</li> <li>◆ Check that the OPERATION indicator on the indoor unit is on; if necessary press  (On/Off) on the remote control.</li> <li>◆ Check whether the TIMER indicator on the indoor unit is switched on. If so:               <ul style="list-style-type: none"> <li>- Wait until the switch-on time is reached and the air conditioner starts up automatically</li> <li>- Cancel the timer (see page 17 for further details)</li> </ul> </li> </ul>
The air conditioner does not operate with the remote control	<ul style="list-style-type: none"> <li>◆ Check that there are no obstacles between you and the indoor unit.</li> <li>◆ Check the remote control batteries.</li> <li>◆ Check that you are close enough to the indoor unit (seven metres/ yards or less).</li> </ul>
No beep is heard when you press  (On/Off) on the remote control	<ul style="list-style-type: none"> <li>◆ Check that you are pointing the remote control at the infrared sensor in the middle of the indoor unit.</li> <li>◆ Replace the remote control batteries if necessary.</li> </ul>
The air conditioner does not cool	<ul style="list-style-type: none"> <li>◆ Check that the correct operating mode has been selected (, ).</li> <li>◆ The room temperature may be too low.</li> <li>◆ Dust may be blocking the air filter guard; refer to page 19 for cleaning instructions.</li> <li>◆ Check that there is no obstacle in front of the outdoor unit.</li> </ul>
The fan speed does not change when you press the  button	<ul style="list-style-type: none"> <li>◆ Check that the operating mode is set to  or ; in the  mode, the fan speed changes automatically and in the  mode, it is set to AUTO.</li> </ul>
The air flow direction does not change when you press the  button	<ul style="list-style-type: none"> <li>◆ Check that the air conditioner has been switched on; if necessary, press  (On/Off) on the remote control.</li> </ul>
The timer is not correctly triggered	<ul style="list-style-type: none"> <li>◆ Check that you have set the clock to the right time; see page 8.</li> <li>◆ Check that the timer has been programmed correctly; see page 15.</li> </ul>
Odours are permeated in the room during air conditioning	<ul style="list-style-type: none"> <li>◆ Air the room.</li> </ul>

## Operating Your Air Conditioner Without the Remote Control

Your air conditioner can be operated directly from the indoor unit if the remote control is lost or broken.

- 1 Open the front grille by pulling on the tabs on the lower right and left sides of the indoor unit.
- 2 To switch the air conditioner on, press the ON/OFF switch on the right side of the indoor unit.

**Result:**

- ◆ The OPERATION indicator on the indoor unit comes on.
- ◆ The indoor unit beeps.
- ◆ The air conditioner starts up in the most suitable mode for the room temperature:

- 3 To switch the air conditioner off, press the ON/OFF switch again.

**Note** Even if the air conditioner has been switched on via the ON/OFF switch, operations can still be controlled using the remote control as usual.

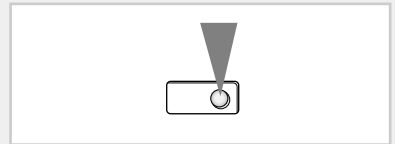
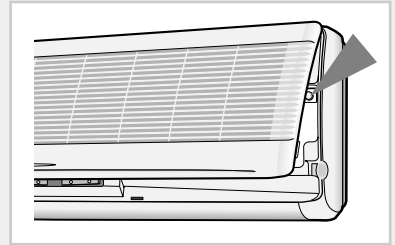

## Installing a Filter (Option)

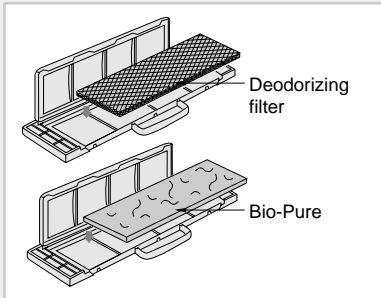

The air conditioner can be fitted with a deodorizing and Bio-Pure filter to remove minute dust particles or odours. The service life of the filter is approximately three months depending on the time during which the air conditioner is used.

- 1 Remove the vinyl packing from the filter.

**Note** Do not remove the packing from a deodorizing filter until you wish to use the filter, as it will lose its properties.

- 2 Insert the filter in the filter holder and press the three insert tabs until you hear a click.
- 3 Open the front grille by pulling on the tabs on the lower right and left sides of the indoor unit.
- 4 Take out the existing filter and replace it with the new one.

## Technical Specifications

Model Indoor unit	Power Supply
AS070VE / 090VE / 120VE	
AS071VE / 091VE / 121VE	220-240V~, 50Hz
AS07A1(A2)VE / 09A1(A2)VE / 12A1(A2)VE	
SC09ZV / 12ZV	
AS070VD / 090VD / 120VD	
AS071VD / 091VD / 121VD	200-220V~, 50Hz
AS09D1(D2)VD / 12D1(D2)VD	
AS070VB / 071VB	220V~, 60Hz
AS07A1(A2)VB / 09A1(A2)VB / 12A1(A2)VB	
AS07A1(A2)VA / 09A1(A2)VA	115V~, 60Hz

THIS AIR CONDITIONER IS MANUFACTURED BY:

