

**600-Watt 7-Piece Home Theater
Audio System**
with 3-DVD/CD changer







REAL

CONTENTS

Important Safety Instructions	3
Note to CATV System Installer	4
The FCC Wants You to Know	4
Notes on Copyright	4
Read Before Using This product	4
Region Management Information	4
Notes on Unauthorized Discs	5
Installing Batteries in the Remote Control	5
Introduction to Your Home Theater System	5
Connections	6
Placing the Receiver	7
Placing the Speakers	7
Connecting the Speakers	7
Connecting a Second Subwoofer	7
Connecting Headphones	7
Connecting Components	7
Connecting a TV	8
Connecting a VCR	8
Connecting a Satellite Receiver or Cable Box	8
Connecting a Digital (Optical) Audio Device	9
Connecting a Cassette Deck	9
Connecting an Auxiliary Audio Device	9
Connecting Antennas	10
FM Indoor Antenna	10
FM Outdoor Antenna	10
AM Indoor Loop Antenna	10
AM Outdoor Antenna	10
Operation	10
A Quick Look at the Display	10
A Quick Look at the Receiver's Controls	11
A Quick Look at the Remote Control	12
Setting up the Surround Sound System	13
Changing the Speaker Distance	13
Changing the Channel Level	13
Changing the Speaker Size	13
Changing the Sound Mode	14
DVD Player Operation	14
Basic Playback	14
Stopping Play	15
Pausing Play	15
Advancing by Frames	15
Playing in Slow-Motion	15
Skipping Chapters	15
Scanning	15
Using Night Mode	16
Recording Audio from the Receiver to Digital Audio Equipment	16
DVD Advanced Features	16
Using GUI Menu Icons	16
Using a Title Menu	16
Using a DVD Menu	17
Changing Subtitle Language	17
Changing Soundtrack Language	17
Viewing from Another Angle	17
Using Repeat Play	17
Zooming In	17

Selecting TV Aspect	17
Selecting Digital Audio Out	18
Playing MP3 Files	18
MP3 Repeat Play	19
MP3 Random Play	19
Using the Tuner	19
Listening To FM Stereo Broadcasts	19
Presetting Radio Stations	19
Manual Preset	19
Auto Preset	20
Switching Between Preset Stations and Manual Tuning	20
Listening to Preset Stations	20
Playing Audio CDs	20
Continuous Play	20
Repeat Play	20
Programming Tracks	21
Modifying the Program and Adding a Track	21
Random Play	21
Using GUI Menu Icons	21
Controlling a Satellite Receiver or Cable Box	21
Using the Sleep Timer	22
Using the Remote Control to Control Additional Components	22
Manufacturer's Codes	22
TV Codes	22
VCR Codes	24
Cable Codes	25
Satellite System Codes	26
Troubleshooting	27
Care	28
Using Discs	28
Cleaning Discs	29
Specifications	29
Amplifier Section	29
Tuner Section	29
Video Section	30
Speaker Section	30
Miscellaneous	30
Setting a Rating Level and Password	31
Selecting a Rating Level	31
Setting a Password	31
Clearing Your Password	31

This audio system is made and tested to meet exacting safety standards. It meets both UL and FCC requirements.

WARNING: To reduce the risk of fire or shock hazard, do not expose this product to rain or moisture.	
 CAUTION 	 The lightning symbol is intended to alert you to the presence of uninsulated dangerous voltage within this product's enclosure that might be of sufficient magnitude to constitute a risk of electric shock. Do not open the product's case.
RISK OF ELECTRIC SHOCK DO NOT OPEN	
CAUTION: TO REDUCE THE RISK OF ELECTRICAL SHOCK, DO NOT REMOVE COVER OR BACK. NO USER-SERVICEABLE PARTS INSIDE. REFER SERVICING TO QUALIFIED PERSONNEL.	 The exclamation mark symbol is intended to inform you that important operating and maintenance instructions are included in the literature accompanying this product.

© 2001, 2002 RadioShack Corporation. All Rights Reserved.

© 1996 Digital Theater System, Inc.

DTS and DTS Digital Surround are trademarks of Digital Theater System, Inc.
All Rights Reserved.

© 1992-1997 Dolby Laboratories, Inc.

Dolby, ProLogic, and the double-D symbol are trademarks of Dolby Laboratories, Inc.
All Rights Reserved.

IMPORTANT SAFETY INSTRUCTIONS

Careful attention is devoted to quality standards in the manufacture of your system, and safety is a major factor in its design. However, safety is also your responsibility.

This section lists important information that will help you properly use and enjoy your system. Read all the included safety and operating instructions before using your system. Follow them closely, and retain them for future reference.

1. Heed Warnings — Follow all warnings on the product and in the operating instructions.
2. Cleaning — Unplug this product from the wall outlet before cleaning. Use only a damp cloth for cleaning. Do not use liquid or aerosol cleaners.
3. Attachments — Do not use attachments/accessories not recommended by the product manufacturer, as they might create a hazard.
4. Water and Moisture — Do not use this product near water (for example, near a bathtub, washbowl, kitchen sink, or laundry tub; in a wet basement; or near a swimming pool).
5. Accessories — Do not place this product on an unstable cart, stand, tripod, bracket, or table. The product may fall, causing serious injury to a child or adult, and serious damage to the product. Use only with a cart, stand, tripod, bracket, or table recommended by the manufacturer or sold with the product. Follow the manufacturer's instructions for mounting, and use a recommended mounting accessory.
6. Carts — Move the product on a cart carefully. Quick stops, excessive force, and uneven surfaces may cause the product/cart to overturn.
7. Disc Tray — Keep your fingers well clear of the disc tray as it is closing. It may cause serious personal injury.
8. Burdening — Do not place a heavy object on or step on the product. The object may fall, causing serious personal injury and serious damage to the product.
9. Connecting — When you connect the product to other equipment, turn off the power and unplug all the equipment from the wall outlet. Failure to do so may cause an electric shock and serious personal injury. Read the owner's manual of the other equipment carefully and follow the instructions when making any connections.
10. Sound Volume — Reduce the volume to the minimum level before you turn on the product. Otherwise, sudden high volume sound may cause hearing or speaker damage.
11. Sound Distortion — Do not allow the product to output distorted sound for an extended period of time. It may cause speaker overheating and fire.
12. Headphones — When you use headphones, keep the volume at a moderate level. If you use headphones continuously with high volume sound, it may cause hearing damage.
13. Laser Beam — Do not look into the opening of the disc tray or ventilation opening of the product to see the source of the laser beam. It may cause sight damage.
14. Disc — Do not use a cracked, deformed, or repaired disc. These discs are easily broken and may cause serious personal injury and product malfunction.
15. Ventilation — Slots and openings in the cabinet provide ventilation, ensure reliable operation, and protect from overheating. Do not block or cover these openings, and do not place the product on a bed, sofa, rug, or other similar surface. Do not place the product in a built-in installation such as a bookcase or rack unless it provides proper ventilation as specified by the manufacturer.
16. Power Sources — Operate this product using only the power source indicated on its marking label. If you are not sure of your home's power type, consult your product dealer or local power company.
17. Polarization — This product is equipped with a polarized AC line plug (a plug having one blade wider than the other). This plug will fit in the power outlet only one way. This is a safety feature. If you cannot insert the plug fully into the outlet, try reversing the plug. If the plug still doesn't fit, contact your electrician to replace your obsolete outlet. Do not defeat the safety purpose of the polarized plug. If you need an extension, use a polarized cord.
18. Power-Cord Protection — Route power-supply cords so they are not likely to be walked on or pinched by items placed on or against them, paying particular attention to cords at plugs, convenience receptacles, and the point where they exit from the product.
19. Lightning — For added protection for this product during a lightning storm, or when it is left unattended and unused for long periods of time, unplug it from the wall outlet and disconnect the antenna or cable system. This will prevent damage to the product due to lightning and power-line surges.
20. Overloading — Do not overload wall outlets, extension cords, or integral convenience receptacles, as this can result in a risk of fire or electric shock.
21. Objects and Liquids — Never push objects of any kind into this product through openings, as they may touch dangerous voltage points or short out parts that could result in a fire or electric shock. Never spill liquid of any kind on the product.
22. Servicing — Do not attempt to service this product yourself, as opening or removing covers may expose you to dangerous voltage or other hazards. Refer all servicing to qualified service personnel.
23. Damage Requiring Service — Unplug this product from the wall outlet and refer servicing to qualified service personnel under the following conditions:
 - When the power-supply cord or plug is damaged.
 - If liquid has been spilled or objects have fallen into the product.
 - If the product has been exposed to rain or water.
 - If the product does not operate normally by following the operating instructions. Adjust only those controls that are covered by the operating instructions, as an improper adjustment of other controls may result in damage and will often require extensive work by a qualified technician to restore the product to normal operation.
 - If the product has been dropped or damaged in any way.
 - When the product exhibits a distinct change in performance.

24. **Replacement Parts** — When replacement parts are required, be sure the service technician uses replacement parts specified by the manufacturer or having the same characteristics as the original part. Unauthorized substitutions may result in fire, electric shock, or other hazards.
25. **Safety Check** — Upon completion of service or repairs to this product, ask the service technician to perform safety checks to determine that the product is in proper operating condition.
26. **Wall or Ceiling Mount** — The product should be mounted to a wall or ceiling only as recommended by the manufacturer.
27. **Heat** — The product should be situated away from heat sources such as radiators, heat registers, stoves, or other products (including amplifiers) that produce heat.
28. **Non-use Periods** — Unplug the system's power cord when you will not use it for extended periods.
29. **Outdoor Antenna Grounding** — If an outside antenna or cable system is connected to the product, be sure the antenna or cable system is grounded so as to provide some protection against voltage surges and built-up static charges. Article 810 of the National Electrical Code, ANSI/NFPA 70, provides information with regard to proper grounding of the mast and supporting structure, grounding of the lead-in wire to an antenna discharge unit, size of grounding conductors, location of antenna-discharge unit, connection to grounding electrodes, and requirements for the grounding electrode.
30. **Power Lines** — An outside antenna system should not be located in the vicinity of overhead power lines or other electric light or power circuits, or where it can fall into such power lines or circuits. When installing an outside antenna system, extreme care should be taken to keep from touching such power lines or circuits as contact with them might be fatal.

Note to CATV System Installer

This reminder is provided to call the CATV system installer's attention to Section 820-40 of the NEC which provides guidelines for proper grounding and, in particular, specifies that the cable ground shall be connected to the grounding system of the building, as close to the point of cable entry as practical.

THE FCC WANTS YOU TO KNOW

This equipment has been tested and found to comply with the limits for a Class B digital device, pursuant to Part 15 of the *FCC Rules*. These limits are designed to provide reasonable

READ BEFORE USING THIS PRODUCT

Warnings:

- This system employs a laser light beam. Only a qualified service person should remove the cover or attempt to service this device, due to possible eye injury.
- The use of controls, adjustments, or procedures other than those specified herein might result in hazardous radiation exposure.

protection against harmful interference in a residential installation. This equipment generates, uses and can radiate radio frequency energy and, if not installed and used in accordance with the instructions, may cause harmful interference to radio communications.

However, there is no guarantee that interference will not occur in a particular installation. If this equipment does cause harmful interference to radio or television reception, which can be determined by turning the equipment off and on, the user is encouraged to try to correct the interference by one or more of the following measures:

- Reorient or relocate the receiving antenna.
- Increase the separation between the equipment and receiver.
- Connect the equipment into an outlet on a circuit different from that to which the receiver is connected.
- Consult your local RadioShack store or an experienced radio/TV technician for help.
- If you cannot eliminate the interference, the FCC requires that you stop using your system.

Changes or modifications not expressly approved by RadioShack may cause interference and void the user's authority to operate the equipment.

NOTES ON COPYRIGHT

It is forbidden by law to copy, broadcast, show, broadcast on cable, play in public, and rent copyrighted material without permission. DVD video discs are copy protected, and any recordings made from these discs will be distorted.

This product incorporates copyright protection technology that is protected by method claims of certain U.S. patents and other intellectual property rights owned by Macrovision Corporation and other rights owners. Use of this copyright protection technology must be authorized by Macrovision Corporation, and is intended for home and other limited viewing uses only, unless otherwise authorized by Macrovision Corporation. Reverse engineering or disassembly is prohibited.

REGION MANAGEMENT INFORMATION

This DVD Player is designed and manufactured to respond to the Region Management Information that is recorded on a DVD disc. If the Region number described on the DVD disc does not correspond to the Region number of this DVD player, this DVD player cannot play that disc.

The Region number of this DVD player is 1 (USA/CANADA).

Notes on Unauthorized Discs

You may not be able to play back some DVD video discs on this player if they were purchased from outside your geographic area or made for business purposes. When you try to play back an unauthorized disc, “Check Regional Code” appears on the TV screen.

INSTALLING BATTERIES IN THE REMOTE CONTROL

Your remote control requires two AAA batteries (not supplied) for power. For the best performance and longest life, we recommend RadioShack alkaline batteries.

Cautions:

- Use only fresh batteries of the required size and recommended type.

INTRODUCTION TO YOUR HOME THEATER SYSTEM

Your Complete 7-Piece 600-Watt Home Theater Audio System is a great system that incorporates some of the best features in home theater technology.

The Home Theater Audio System comes complete with a shielded center-channel speaker, a low pass-type subwoofer, two shielded front-channel speakers, two surround speakers, a remote control, and a receiver equipped with a tuner and a built-in 3-disc DVD/CD changer. The DVD/CD changer is **CDR/CDRW** and **MP3** compatible to play the most popular music formats.

Dolby Digital, Dolby ProLogic, and DTS Sound Settings — let you use the Home Theater Audio System for a movie-theater surround sound experience

Adjustable Speaker Size, Channel Level, and Distance — let you customize your setup for a true surround sound experience

Additional Component Connections — let you connect other audio and audio/visual components to the receiver so you can enjoy them with this system’s surround sound capabilities

Night Mode — lets you compress the dynamic range, reducing the difference in loudness between different sounds in Dolby Digital mode, allowing you to enjoy the full effect of the system capabilities at lower volumes

Parental Lock (Rating Level) — lets you set a ratings level so that your children cannot watch a DVD that has a rating higher than you set (see “Selecting a Rating Level” on Page 31)

Sleep Timer — lets you program the receiver to turn off after a set time period

- Do not mix old and new batteries or different types of batteries.

1. Slide the battery compartment cover in the direction of the arrow to remove it.
2. Place the batteries in the compartment as indicated by the polarity symbols (+ and -) marked inside.
3. Replace the cover.

When the remote control stops operating properly, replace the batteries.

Warning: Dispose of old batteries promptly and properly. Do not burn or bury them.

Caution: If you do not plan to use the remote control for a month or longer, remove the batteries. Batteries can leak chemicals that can destroy electronic parts.

Universal A/V Remote Control — eliminates the need for multiple remotes in home theatre operations

CONNECTIONS

Front and Surround (rear) speakers can be wall-mounted or placed on a stand (mounting hardware and stands not included.)

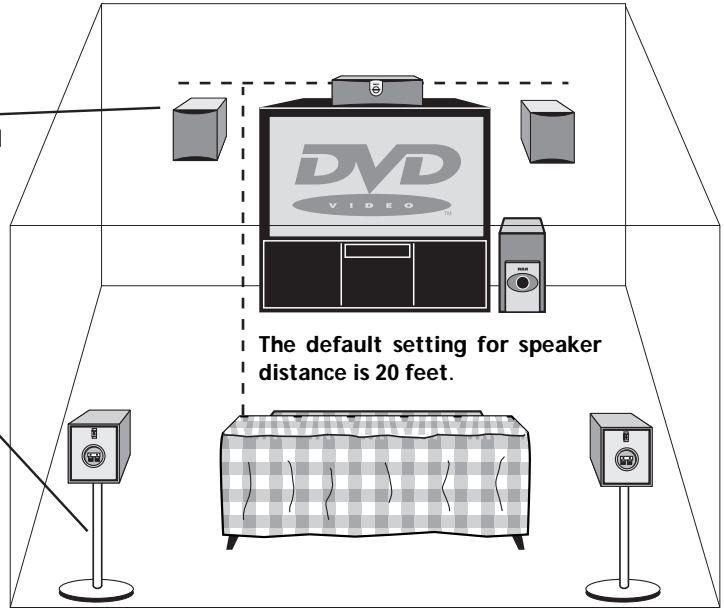

Typical Speaker Placement

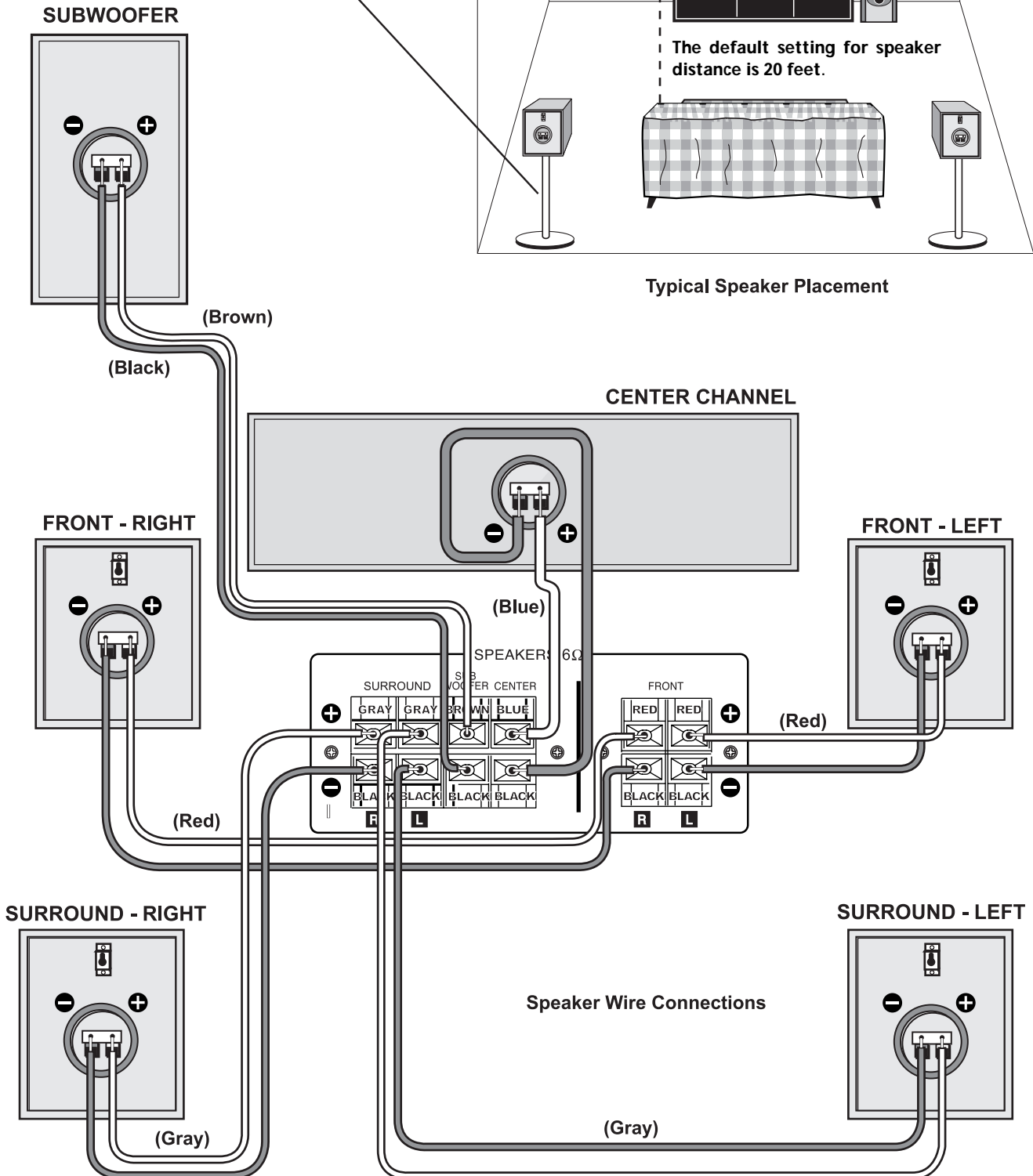

PLACING THE RECEIVER

Do not place objects directly on top of the receiver as it could prevent proper heat dispersal.

When installing in a rack or shelf, be sure to leave an adequate amount of space above and behind the receiver for air circulation.

PLACING THE SPEAKERS

1. Place the front left and right speakers at equal distances from the TV.
2. Install the center speaker above or below the TV so the center channel's sound is localized at the TV screen.

Caution: If you choose to install the center speaker on top of the TV, be sure to secure it to reduce the risk of damage or injury resulting from the speaker falling from the TV in the event of external shocks (for example, earthquakes).

3. Install the surround speakers slightly above ear level.

Note: Try not to install the surround speakers farther away from the listening position than the front and center speakers. Doing so can weaken the surround effect.

4. Place the subwoofer on the floor near the TV.

Caution: Be sure all speakers are installed securely to prevent accidents and improve sound quality.

CONNECTING THE SPEAKERS

Caution: When connecting equipment, always make sure the power is switched off and the power cord is disconnected from the AC outlet.

Notes:

- Use speakers with a nominal impedance of 6 Ohms or more.
- Be careful not to bend cables over the top of the receiver. If cables are placed on top of the receiver, the magnetic field produced by the receiver's transformers can cause the speakers to produce a humming noise.

1. Press the speaker's terminal up (or down) and insert the appropriate wire ends. The color of the speaker wire's plastic coating matches the corresponding terminal.

Note: Be sure to connect each speaker to the appropriate speaker terminal, connecting positive to positive (+ to +) and negative to negative (- to -).

2. Connect the front speakers' wires to the receiver's **SPEAKERS FRONT L** (Red/Black) and **R** (Red/Black) terminals.

Connect the surround speakers' wires to the receiver's **SPEAKERS SURROUND L** (Gray/Black) and **R** (Gray/Black) terminals.

Connect the center speaker's wires to the receiver's **SPEAKERS CENTER** terminals (Blue/Black).

Connect the subwoofer's wires to the receiver's **SPEAKERS SUB WOOFER** terminals (Brown/Black).

3. Release the speaker terminal.
4. Plug the AC power cord into an AC outlet.

Connecting a Second Subwoofer

You can connect a second or larger powered subwoofer to the system. Connect the sub woofer to the receiver's **SUB WOOFER PRE-OUT** jack using shielded audio cable (not supplied).

CONNECTING HEADPHONES

You may connect a conventional dynamic headphone with a 1/4 inch plug to the **PHONES** jack on the front of the receiver.

When you connect headphones, the receiver automatically selects stereo mode.

Note: When you connect headphones, the sound from the speakers is automatically muted. When you remove the headphones, the speakers' volume is restored.

CONNECTING COMPONENTS

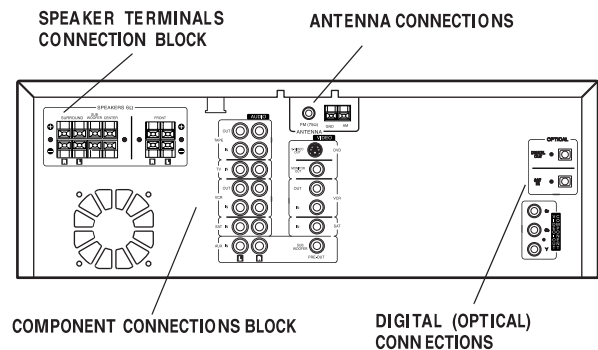

Caution: When connecting equipment, always make sure the power is switched off and the power cord is disconnected from the AC outlet.

You must connect a TV to the receiver in order to use the receiver's DVD player to watch DVDs. You can also connect other audio and audio/visual components to the receiver in order to fully utilize the Home Theater Audio System's surround sound capabilities.

Note: The system comes with one set of audio/video cables. Your local RadioShack store sells a wide variety of audio/video cables if you need cables to connect more components.

Connecting a TV

Use audio/video cables or an S-Video cable (not supplied) to connect a TV to the receiver.

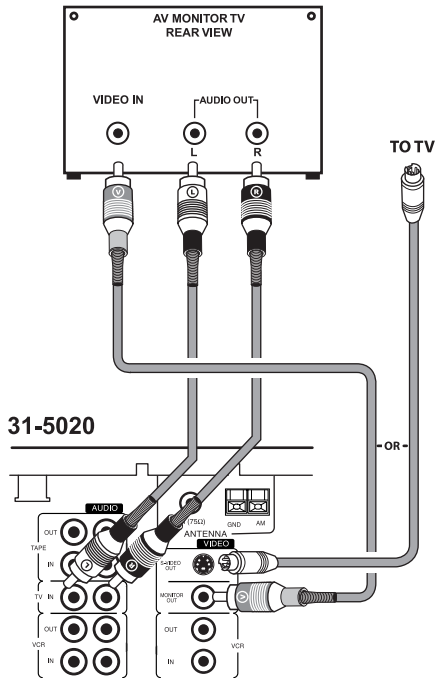

1. For audio, connect the plug from the TV's AUDIO OUT right jack to the receiver's right **AUDIO TV IN** jack and the plug from the TV's AUDIO OUT left jack to the receiver's left **AUDIO TV IN** jack.
2. If your TV has an S-Video jack, use an S-Video cable to connect your TV to the receiver's **S-VIDEO OUT** jack.

If your TV has component video jacks, use a component video cable to connect your TV to the receiver's **COMPONENT VIDEO OUT** jacks (Cr, Cb, Y).

If your TV does not have component video jacks, or an S-Video jack, use an audio/video cord to connect your TV to the receiver's **MONITOR OUT**.

Important: The receiver's **S-VIDEO** jack and **COMPONENT VIDEO OUT** jacks are for use with the built-in 3-disc DVD player only. If you plan to use a VCR, satellite receiver, or other equipment with this receiver, you must use audio/visual cables to connect your TV to **MONITOR OUT** (and view DVDs through **MONITOR OUT** as well).

Note: Do not connect your TV to both the **COMPONENT VIDEO OUT** or **S-VIDEO** and **MONITOR OUT** jacks.

Connecting a VCR

Use audio/video cables (not supplied) to connect a VCR to the receiver.

1. Connect red plugs to the right **AUDIO** jacks and white plugs to the left **AUDIO** jacks.
2. Connect yellow plugs to the **VIDEO** jacks.

3. Use a coaxial cable (not supplied) to connect the TV OUT (or ANTENNA OUT) on the VCR to the ANTENNA IN on your TV (or TV monitor).

Note: Make sure you connect the VCR to both the **IN** and **OUT** sets of jacks.

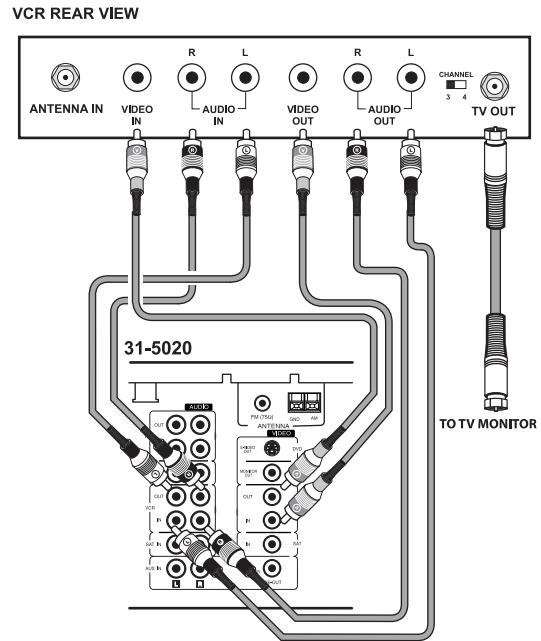

Connecting a Satellite Receiver or Cable Box

Use audio/video cables (not supplied) to connect a satellite receiver or cable box to the receiver.

Note: Your cable box or satellite receiver must use audio/video cables or a Toslink optical cable to connect to the receiver. If your equipment only uses coaxial cable, you cannot connect it to the receiver.

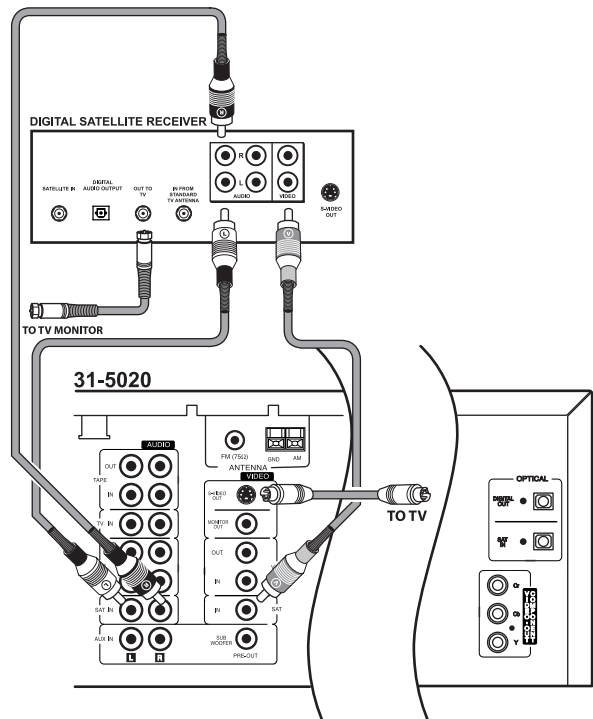

1. Connect the yellow plug to the **VIDEO** jack.
2. If your satellite receiver or cable box has analog audio connections, connect red plugs to the right **AUDIO** jacks and white plugs to the left **AUDIO** jacks. To use your satellite receiver (or cable box), select the SAT function (see "Controlling a Satellite Receiver or Cable Box" on Page 21).

If your satellite receiver or cable box has digital audio output, use an optical cable to connect the satellite receiver to the home theater receiver's **SAT IN** optical jack. To use your satellite receiver or cable box, select the SAT-OPT function (see "Controlling a Satellite Receiver or Cable Box" on Page 21).

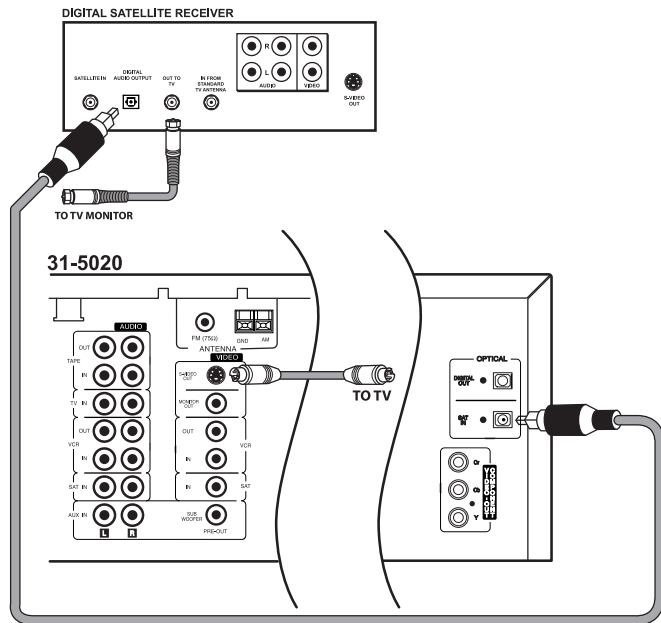

Connecting a Digital (Optical) Audio Device

You can connect a digital audio device such as an MD (Mini Disc) or DAT (Digital AudioTape) recorder to the receiver's **DIGITAL OUT** to record audio from the receiver. Use Toslink optical cable to connect the MD or DAT recorder to the receiver's **DIGITAL OUT** optical jack.

You can also connect a satellite receiver, portable CD player, MD or DAT recorder, or other components with digital output to the receiver's **SAT IN** optical jack. Use Toslink optical cable to connect the desired device to the receiver.

Caution: If an active digital audio output signal is supplied to a receiver or other equipment without a corresponding digital decoding capability, a very loud noise might be produced which could permanently damage your speakers.

Connecting a Cassette Deck

Use audio/video cables (not supplied) to connect a cassette deck to the receiver. Connect red plugs to the right **AUDIO** jacks and white plugs to the left **AUDIO** jacks. Make sure you connect the cassette deck to both the **TAPE IN** and **TAPE OUT** sets of jacks.

Note: If the cassette deck is placed too close to the receiver, noise might occur during cassette playback. If this happens, move the cassette deck farther away from the receiver.

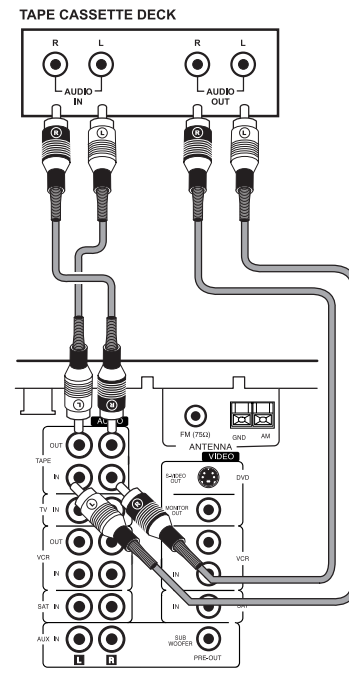

31-5020

Connecting an Auxiliary Audio Device

You can also connect an audio device that does not require Toslink (such as an MP3 player, playback cassette deck, or portable CD player) to the Home Theater Audio System.

1. Use audio cables to connect the desired device to the receiver's **AUX** jacks.
2. Connect red plugs to the right **AUDIO** jacks and white plugs to the left **AUDIO** jacks.

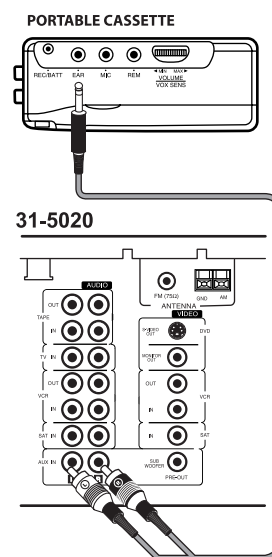

31-5020

CONNECTING ANTENNAS

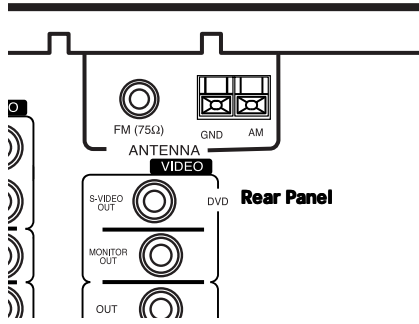

FM Indoor Antenna

In an area with strong FM signals, the T-type FM antenna (supplied) is sufficient.

1. Use a flat or Phillips screwdriver to loosen the screws on the supplied transformer.
2. Place the metal connectors on the end of the T-type antenna's base on the transformer's metal contacts (underneath the screw heads) then tighten the screws.
3. Plug the transformer into **ANTENNA FM 75 Ω**
4. Extend the T-antenna's other two wires and attach them to a wall or window frame for the best possible reception.

Note: If you have an FM antenna that uses coaxial cable, connect it directly to **ANTENNA FM 75 Ω**

FM Outdoor Antenna

In an area where FM signals are weak, you must use a 75-ohm unbalanced-type outdoor FM antenna (not supplied). Generally, a 3-element antenna will be sufficient. If you live in

an area where the FM signals are particularly weak, it may be necessary to use one with 5 or more elements.

If you have an FM antenna that uses coaxial cable, connect it directly to **ANTENNA FM 75 Ω**

If you have a twin-lead FM antenna, connect it to the supplied transformer, then plug the transformer into **ANTENNA FM 75 Ω**. (see Steps 1–3 of "FM Indoor Antenna").

AM Indoor Loop Antenna

The supplied high-performance AM loop antenna is sufficient for good reception in most areas.

Connect the loop antenna's wires to **AM** and **GND**. Place the antenna in a location (for example, on a shelf or window frame) that gives the best reception.

Keep the antenna as far away as possible from the entire system, speaker cords and the power cord to prevent unwanted noise.

AM Outdoor Antenna

If the supplied AM loop antenna does not deliver sufficient reception, use an outdoor AM antenna (not supplied).

Use an insulated wire more than 15 feet (5 m) long. Strip one end, and connect that end to **AM**.

String the antenna wire outdoors or indoors near a window. For better reception, connect the **GND** terminal to a reliable ground.

OPERATION

A QUICK LOOK AT THE DISPLAY

Disc Mode Indicators — Show which disc and what type of disc is playing. Shows the play mode, such as random or repeat.

Title Indicator

Track Indicator

Chapter Indicator

Mute Indicator

Tuner Indicators — (see "Using the Tuner" on Page 19).

Memory Preset Indicators — (see "Presetting Radio Stations" on Page 19)

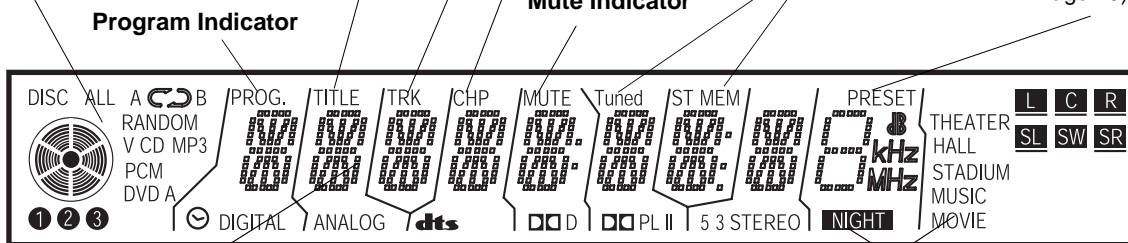

Program Indicator

Number & Data Readout — Area where information is displayed in digital format

Sound Mode indicators — (see "Changing the Sound Mode" on Page 14)

Night Indicator — "Using Night Mode" on Page 16

A QUICK LOOK AT THE RECEIVER'S CONTROLS

DISC SKIP/TUNING MODE – Press to skip discs in DVD/CD mode. In tuner mode, press to switch between presets and manual tuning (see “Switching Between Preset Stations and Manual Tuning” on Page 20).

TUNING/PRESET – Repeatedly press to tune to AM or FM stations and select preset stations in tuner mode. In DVD/CD mode, can also be used to skip and scan through discs.

BAND/PLAY – Press to select AM or FM band in tuner mode. Press to play back the disc in DVD/CD mode.

FUNCTION – Rotate to select the desired audio or audio/video source. The selected source name appears on the display panel.

DISC 1, 2, 3 – Press to open or close the disc trays. Note: You cannot use these buttons in tuner mode.

VOLUME — Rotate to set the desired volume.

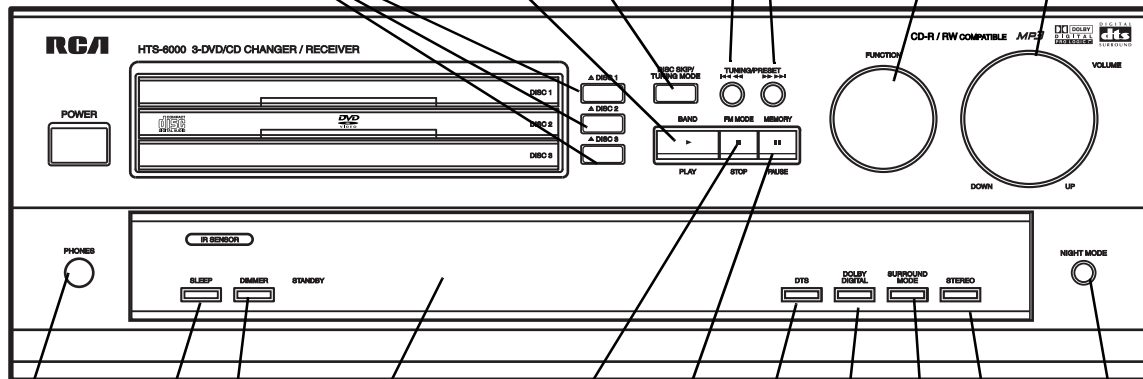

PHONES – This jack is compatible with many conventional dynamic headphone types.

Display Panel — See “A Quick Look at the Display” on Page 10.

SLEEP – Repeatedly press to set the sleep timer.

DIMMER – Press once to dim the display panel or to return it to normal.

FM MODE/STOP – In tuner mode, press to select mode for FM. In DVD/CD mode, press to stop the disc.

MEMORY/PAUSE – Stores a station in memory in tuner mode; pauses the disc in DVD/CD mode.

DTS – Press to switch to 5.1 Channel DTS.

DOLBY DIGITAL – Press to switch to 5.1 Channel Dolby Digital.

NIGHT MODE – Press to compress large dynamic range (see “Using Night Mode” on Page 16).

STEREO – Press to switch to stereo mode.

SURROUND MODE – Press to switch between surround sound modes.

A QUICK LOOK AT THE REMOTE CONTROL

MUTE — Press to immediately stifle the sound level. **MUTE** appears on the receiver's display panel. To restore the sound, press again.

COMPONENT SELECTION KEYS — Press to select or to control a desired component.

PRESET+/I<< >>I — Press to make selections in tuner mode (see "Using the Tuner" on Page 19). In DVD/CD mode, functions as skip ahead or skip back.

FM MODE/■ — Selects FM mono or stereo mode while using the tuner. Functions as **STOP** in DVD/CD mode.

BAND/▶ — Selects AM or FM band while using the tuner. Functions as **PLAY** in DVD/CD mode.

MEMORY/II — Press to memorize the desired station frequency in tuner mode. Functions as **PAUSE** in DVD/CD mode.

PROGRAM — Press to enter a specific desired sequences of CD tracks (see "Programming Tracks" on Page 21).

REPEAT — Press to cycle through repeat modes (see "Repeat Play" on Page 20).

RANDOM — Press to "shuffle" or play CD tracks in a random order (see "Random Play" on Page 21).

DISC SKIP — Press to progress to the next DVD or CD loaded.

SURROUND — Repeatedly press to change the surround mode (see "Changing the Sound Mode" on Page 14).

TEST TONE — Turns on or off the test tone function in DTS, DOLBY DIGITAL, or PRO LOGIC mode. The test tone is output from Front L speaker, Center speaker, Front R speaker, Surround R speaker, Surround L speaker, (Subwoofer speaker when Subwoofer is on).

TONE — Press **TONE** as necessary until **TONE ON** appears. Adjust the low frequency level (BASS) with ◀ or ▶. You can also adjust high frequency level (TREBLE) with ▲ or ▼. To keep your settings, let TONE time out. To let the receiver control the tone, press **TONE**. **TONE OFF** appears. The tone returns to the default settings.

SLEEP — Press to set the sleep time.

TUNING MODE — Selects and deselects preset mode.

SET UP — Press to enter customized settings for the system speakers (see "Setting up the Surround Sound System" on Page 13).

GUI (Graphic User Interface) — Press to access disc information and functions (see "Using GUI Menu Icons" on Pages 14 and 19).

DVD SPECIAL FUNCTIONS:

MENU	See "Using a DVD Menu" on Page 17.
TITLE	See "Using a Title Menu" on Page 16.
ANGLE	See "Viewing from Another Angle" on Page 17.
ZOOM	See "Zooming In" on Page 17.
AUDIO	See "Changing Soundtrack Language" on Page 17.
SUB TITLE	See "Changing Subtitle Language" on Page 17.
SLOW	See "Playing in Slow-Motion" on Page 15.

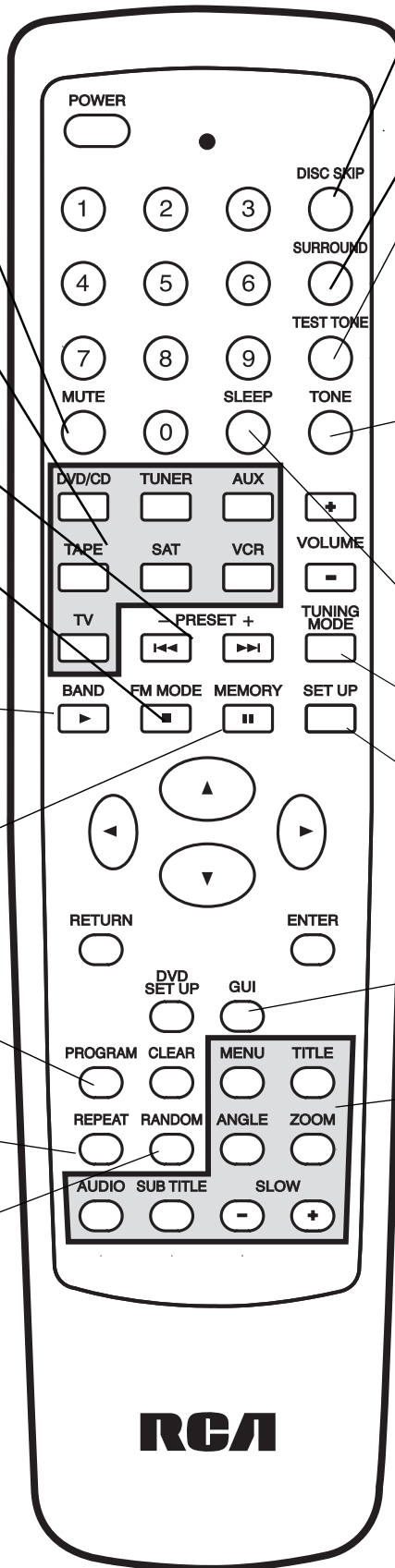

The remote control may not work properly if:

- There are obstacles between the remote control and the receiver's remote sensor.
- Direct sunlight or fluorescent light is shining onto the remote sensor.
- The receiver is located near a device that is emitting infrared rays.
- The receiver is operated simultaneously with another infrared remote control.

SETTING UP THE SURROUND SOUND SYSTEM









Your Home Theater Audio System speakers are timbre matched and ready to use “as is” as soon as you unpack them. If you wish to fine-tune the system (for example, substitute different speakers or alter the sound distribution), follow the directions below.



Important Notes:

- To change the surround sound settings, the receiver must be in a surround mode that uses all the speakers (for example, Dolby Digital).
- The center and surround speakers only operate when the receiver is set to a surround sound mode and the source material being played is recorded or broadcast in Dolby Digital, DTS or Dolby Pro Logic surround sound.
- Stereo broadcasts or recordings will produce some surround channel effects when played in a surround mode. However, mono sources will not produce any sound from the surround speakers.

Changing the Speaker Distance





















When you have arranged your home theater (speakers, receiver, and any components), you can change the speaker distance entered in the receiver’s memory. The default setting is 20 feet.

1. Imagine a straight line from the front left speaker to the front right speaker.
2. Measure the distance in a perpendicular line from your listening position (for example, your couch) to the imaginary line. (See illustration on page 6.)
Note: Do not measure the distance to the speakers, just the line.
3. Repeat Steps 1–2 for the surround speakers.
4. Measure the distance in a perpendicular line from your listening position (for example, your couch) to the center speaker.
5.  Press **SETUP**, then press  twice. **SP DIST** appears.
6. Press . **FRONT** appears.
7. Press  again. **F 20FT** appears. To change the distance between the listening position and the front speakers, repeatedly press  or  until you reach the desired distance (**1 to 30 FT**).
8. Press **ENTER**. **CENTER** appears.
9. Press . **C 20FT** appears. To change the distance between the listening position and the center speaker, repeatedly press  or  until you reach the desired distance (**1 to 30 FT**).
10. Press **ENTER**. **SURR.** appears.

11. Press . **S 20FT** appears. To change the distance between the listening position and the surround speakers, repeatedly press  or  until you reach the desired level (**1 to 30 FT**).
12. Press **ENTER**. **FRONT** appears.
13. Press **SETUP** to exit.

Changing the Channel Level















The default channel level settings are 0 dB for each speaker. You can change the speakers’ sound distribution to suit your surround sound needs. For example, if you are closer to the left front speaker than the right front speaker, the left front speaker might seem “louder” than the right one. To adjust it, you must change the channel level for one or both speakers until the sound evens out.

1.  Press **SETUP**, then . **CH LEVEL** appears.
2. Press . **FL LEVEL** appears.
3. Press  again. **FL 0dB** appears. To change the front left speaker’s level, repeatedly press  or  until you reach the desired level (**-10 to +10 dB**).
4. Press **ENTER**. **C LEVEL** appears.
5. Press . **C 0dB** appears. To change the center speaker’s level, repeatedly press  or  until you reach the desired level (**-10 to +10 dB**).
6. Press **ENTER**. **FR LEVEL** appears.
7. Press . **FR 0dB** appears. To change the front right speaker’s level, repeatedly press  or  until you reach the desired level (**-10 to +10 dB**).
8. Press **ENTER**. **SR LEVEL** appears.
9. Press . **SR 0dB** appears. To change the right surround speaker’s level, repeatedly press  or  until you reach the desired level (**-10 to +10 dB**).
10. Press **ENTER**. **SL LEVEL** appears.
11. Press . **SL 0dB** appears. To change the left surround speaker’s level, repeatedly press  or  until you reach the desired level (**-10 to +10 dB**).
12. Press **ENTER**. **SW LEVEL** appears.
13. Press . **SW 0dB** appears. To change the sub woofer’s level, repeatedly press  or  until you reach the desired level (**-10 to +10 dB**).
14. Press **ENTER**. **FL LEVEL** appears.
15. Press **SETUP** to exit.

Changing the Speaker Size

Note: If you are using the speakers provided in your Home Theater Audio System, the speaker size defaults are correct. If you are using other speakers, follow these steps.



1.  Press **POWER**.

2.  Press **SETUP SP SIZE** appears.
 3. Press . **FRONT** appears.
 4. Press  again. **F-SMALL** appears. To change to **F-LARGE**, press  or .
- Note:** If the cone size (diameter) of the speaker is larger than 5 inches, change to **F-LARGE**.
5. Press **ENTER**. If you have not changed the default setting, **CENTER** appears. If you have changed the setting, **ENTER** flashes and the previously entered setting change appears. Press **ENTER** again so **CENTER** appears.
 6. Press . **C-SMALL** appears. To change to **C-LARGE**, press . To change to **C-NONE**, press  again.
- Note:** If the cone size (diameter) of the speaker is larger than 5 inches, set the item to **C-LARGE**.
7. Press **ENTER**. (Refer to step 5 for similar conditions to make **SURR** appear.)
 8. Press . **S-SMALL** appears. To change to **S-LARGE**, press . To change to **S-NONE**, press  again.
- Note:** If the cone size (diameter) of the speaker is larger than 5 inches, set the item to **S-LARGE**.
9. Press **ENTER**. (Refer to step 5 for similar conditions to make **SUB-WF** appear.)
 10. Press . **SW-YES** appears. If you are not using a subwoofer, press  or  to change to **SW-NO**.
- Note:** If the front speaker is set to **F-SMALL**, the subwoofer cannot be set to **SW-NO**.
11. Press **ENTER**. (Refer to step 5 for similar conditions to make **FRONT** appear.)
 12. Press **SETUP** to exit.



Changing the Sound Mode

 For an analog source (Tuner, SAT, TV, Tape, CD or AUX), repeatedly press **SURROUND MODE** until the desired mode (**THEATER, HALL, STADIUM, PRO LOGIC, PRO LOGIC II MOVIE, or PRO LOGIC II MUSIC**) appears. Press **STEREO** to select stereo.

 You may also repeatedly press **SURROUND** on the remote until the desired mode appears.

 or  For a digital source (DVD or SAT-OPT), **SURROUND** on the remote changes Dolby Digital sound to Dolby Digital Stereo sound or DTS sound to DTS Stereo sound. Press **SURROUND** again to return to the original sound mode. To change Dolby Digital to Dolby Digital Stereo or DTS to DTS Stereo with the receiver, press **STEREO**. Press **DOLBY DIGITAL** or **DTS** on the receiver to return to the original mode.



Note: If your DVD is encoded for 5.1 Dolby Digital sound, pressing **SURROUND** changes the mode from Dolby Digital to Dolby Digital Stereo. If the DVD is encoded for anything less than 5.1 Dolby Digital Sound, the DVD plays in Dolby ProLogic mode and pressing **SURROUND** changes Dolby ProLogic to Dolby Digital Stereo.

 or  For a surround mode, repeatedly press **SURROUND MODE** (or **SURROUND** on the remote) until the desired mode (**THEATER, HALL, STADIUM, STEREO, or PRO LOGIC, PRO LOGIC II MOVIE, or PRO LOGIC II MUSIC**) appears.

Note: Dolby Digital and DTS modes only work with CDs encoded to use these modes.





DVD PLAYER OPERATION

Basic Playback

1.  or  Press **POWER**. The last selected function appears.
 2. If necessary, press the remote's **DVD/CD** or rotate the receiver's **FUNCTION** until **DVD/CD** appears.
 3. Press **DISC 1, DISC 2, or DISC 3** to open the desired disc tray.
- Note:** The disc indicators light even if there is not a disc in the tray. The receiver checks the tray after you press the receiver's **PLAY** or the remote's **BAND/▶**. Only the indicators that have a disc remain lit.
4. Place a disc on the disc tray with the label side up. Place the disc in the correct guide on the disc tray. If the disc is out of the guide, it may damage the disc and cause the DVD player to malfunction.

Caution: Do not press on the drawers to close them. Doing so can damage the drawers.

Notes:



- If you leave the disc tray open, the disc tray closes automatically after eight minutes, or when the function mode is changed.
 - If your DVD is double-sided (with features on both sides), place the DVD in the tray with the desired side's label facing up.
 - 96 kHz, 24 bit, two-channel DVD discs are played in stereo mode only.
5. Press **PLAY** on the receiver or **BAND/▶** on the remote. **PLAY** appears. The disc tray closes and the receiver loads the disc. After loading the disc, the receiver enters menu mode.
- Note:** If you close the tray by pressing **DISC 1, DISC 2, or DISC 3**, the receiver does not load the disc. Press **PLAY** to load the disc.
6. To select another disc, press **DISC SKIP** as necessary on the remote, or the receiver, until the desired disc loads.
- Note:** After playing back all of the chapters in the title, the DVD player automatically stops and returns to the menu screen.
7. When the menu screen appears on your television screen, press the remote's , , , or  to select the Play

Movie option, then press the remote's **BAND/▶** or the receiver's **PLAY**. The receiver begins playback.

Cautions:

- Do not move the DVD player during playback. Doing so might damage the disc and the receiver.
- Use **DISC 1**, **DISC 2**, or **DISC 3** on the main receiver to open or close the disc trays. Do not push the disc tray while it is moving. Doing so may cause the DVD player to malfunction.
- Do not push on the disc tray or put any objects other than discs on the disc tray. Doing so may cause the DVD player to malfunction.
- Keep your fingers well clear of the disc tray as it is closing. Keep children's fingers away from the closing disc tray as there is a risk of personal injury.
- When a button is pressed, and its function is not available on the disc you are playing,  appears on the TV screen.
- Depending on the DVD disc, some operations may be different or restricted. Refer to the jacket or case of the disc you are playing.

Stopping Play

 or  Press **STOP** on the receiver or **FM MODE/■** on the remote. When play is stopped, the receiver remains at the point where it was stopped. **RESUME** appears on the display.



To resume play, press **PLAY** on the receiver or **BAND/▶** on the remote. Playback resumes from the point at which you stopped play.

To stop play completely, press **STOP** on the receiver or **FM MODE/■** on the remote again.



Notes:

- The resume option is cleared when **STOP** on the receiver or **FM MODE/■** on the remote is pressed the second time. The resume option is also cleared when the power is turned off and then on.
- The resume option works only with discs for which the elapsed playing time appears on the window display during playback.
- Opening the disc tray cancels the resume option.
- The resume option may not be available on some DVD discs.

Pausing Play

1.  or  Press **||** on the receiver or **MEMORY/||** on the remote.
2. To resume normal playback, press **PLAY** on the receiver or **BAND/▶** on the remote.

Advancing by Frames

1.  or  Press **||** on the receiver or **MEMORY/||** on the remote while the DVD is paused. Each time you press **||** on the receiver or **MEMORY/||** on the remote, the picture advances one frame.
2. To resume normal playback, press **PLAY** on the receiver or **BAND/▶** on the remote.

Playing in Slow-Motion

 Press **SLOW -/+** on the remote during playback. During slow playback, the playback speed and direction can be selected with **SLOW -/+**.

To decrease the playback speed, repeatedly press **SLOW +**. As you press **SLOW +** the playback speed slows ($1/2X$, $1/4X$, $1/8X$).

To reverse the playback direction, press **SLOW -**.



To return to normal playback, press **PLAY** on the receiver, or **BAND/▶** on the remote.

Skipping Chapters

 To skip forward, press **PRESET ▶▶▶**. The receiver skips forward one chapter each time you press **PRESET ▶▶▶**.

To skip backward, press **PRESET ◀◀◀**. The receiver skips backward one chapter each subsequent time you press **PRESET ◀◀◀**.

Scanning

 or  To scan forward through a DVD, hold down **PRESET ▶▶▶▶** on the receiver or **PRESET ▶▶▶** on the remote for more than 1 second. Repeat up to three times to increase the fast-forward speed (2X on the first press, then 4X, then 16X, and finally 100X). To resume playback, press the receiver's **PLAY** or the remote's **BAND/▶**.

To scan backward through a DVD, hold down the **PRESET ◀◀◀◀** on the receiver or **PRESET ◀▶▶** on the remote for more than 1 second. Repeat up to three times to increase the fast-reverse speed (2X on the first press, then 4X, then 16X, and finally 100X). To resume playback, press **PLAY** on the receiver or **BAND/▶** on the remote.

Notes:

- The DVD player does not play back sound during slow-motion, high-speed-reverse, or high-speed-forward playback of DVDs.
- Subtitles do not appear on the screen during scan playback higher than 2X, reverse scan, or reverse slow motion.
- The DVD player provides four scan speeds in each direction for DVD movie play.

Using Night Mode

You can use Night Mode to compress large dynamic ranges, resulting in “quieter” explosions and other loud sounds in movies. The Night Mode feature adjusts the dynamic range so that there is less disparity in the noise level of all sounds in a movie (explosions, music, dialogue, and so on).

 While in Dolby Digital or Dolby Digital Stereo mode, press **NIGHT MODE** to turn Night Mode on. The receiver displays **NIGHT**. Press **NIGHT MODE** again to turn it off.

Note: Night Mode is not available for movies using DTS mode, or when the audio is set to PCM mode.

Recording Audio from the Receiver to Digital Audio Equipment

Some DVDs might be encoded with an anti-copy digital signal. If this is the case, you must disconnect your MD recorder (or other digital equipment) from the **DIGITAL OUT** jack on the receiver’s back. Use audio/video cables to connect the equipment to **TAPE OUT**.

Note: To ensure proper recording quality when you make a copy of a DVD/CD via TAPE output, set the front speaker size to **F-LARGE** (see “Changing the Speaker Size” on Page 13). Set the surround mode to **STEREO**.

DVD ADVANCED FEATURES

For the advanced features, the receiver’s display screen does not change. The display appears on your television screen.

Using GUI Menu Icons

GUI (Graphic User Interface) menu icons show disc information (for example, title or chapter number, elapsed playing time, audio/subtitle language, angle) and player information (for example, repeat play, play mode). Some icons only allow you to view the indicated information. Other icons allow you to change the settings.

Note: All GUI functions are only available through your remote control. You cannot use the receiver to access GUI menus.



1.  Press **GUI** during playback.

Icons of the current title number, current chapter number, elapsed time, the current audio soundtrack language, current subtitle language, and current angle number appear.

Below each icon is the current information for that menu (for example, **2** appears under the chapter icon when you are watching the movie’s second chapter).

Notes:

- Some DVDs might not provide all of the above GUI menu icons.

- The on-screen GUI menu will disappear (time out) if you do not press a button within 10 seconds.
2. Press the remote’s  or  to select the desired item. The currently selected item is highlighted.

The first icon is the title icon. When you select it, you can jump to the desired title number by pressing the remote’s number keys, then **ENTER**.



The second icon is the chapter icon. When you select it, you can jump to the desired chapter number by pressing the remote’s number keys, then **ENTER**.



The third icon is the time icon. When you select it, you can move to a desired time in the movie by pressing the number keys, then **ENTER**.



The fourth icon is the audio icon. When you select it, you can change the soundtrack language by repeatedly pressing **AUDIO** until the desired language appears. To select the current setting, press **ENTER**.



The fifth icon is the subtitle icon. When you select it, you can change the subtitle language by repeatedly pressing **SUB TITLE** until the desired language appears. To select the current setting, press **ENTER**.



The last icon is the angle icon. When you select it, you can change the angle by repeatedly pressing **ANGLE** until the desired number appears. To select the current setting, press **ENTER**.



Using a Title Menu

Some DVDs may contain two or more titles. If the disc has a title menu recorded on it, you can use **TITLE** to select the movie title.

Notes:

- The details of operation might differ depending on the DVD.
 - Selecting a title might not be possible on certain DVD discs.
1.  Press **TITLE**. A list of the DVD’s titles appears.
 2. Press **BAND/▶** or **ENTER** to resume play from the scene when **TITLE** was first pressed.
 3. Press **▲**, **▼**, **◀**, or **▶**, then **ENTER** or **BAND/▶**. Or press the numeric button(s), to select the desired title. The selected title starts playing.

Using a DVD Menu

Some DVDs have unique DVD menus. For example, DVDs programmed with complex contents provide guide menus, and those recorded with various languages provide menus for audio and subtitle language.

The DVD menu's contents and operation differ from disc to disc. The following procedure explains the basic operation when this feature is used.

1.  Press **MENU** during play. The DVD menu available on the disc now appears. Pressing **RETURN** resumes play from the scene when **MENU** was first pressed.

Note: The resume play option might not be possible on certain discs.

2. Press **▲**, **▼**, **◀**, or **▶** on the remote, then **ENTER**. Or press the numeric button(s) to select the desired item. The selected item is now executed.

Changing Subtitle Language

Note: This operation works only with DVDs with multiple subtitle languages.

1.  Press **SUB TITLE** during playback. When no subtitles are recorded, **OFF** appears instead of the language number.
2. Repeatedly press **SUB TITLE** until the desired language is selected.

To eliminate subtitles, repeatedly press **SUB TITLE** and select **OFF**.

Notes:

- When the desired language is not selected even after pressing the button several times, it means the language is not available on the disc.
- When the power is turned off or the DVD is completely stopped, the subtitle language reverts to the DVD's default setting.

Changing Soundtrack Language

Note: This operation works only with DVDs with multiple soundtrack languages.

1.  Press **AUDIO** during play. The currently selected soundtrack language appears.
2. Repeatedly press **AUDIO** until the desired language is selected.

Notes:

- When the desired language is not selected even after pressing the button several times, it means the language is not available on the disc.

- When the power is turned off or the DVD player is stopped, the language heard is the one selected at the initial settings.

Viewing from Another Angle

Some DVDs may contain scenes shot simultaneously from different angles. For these discs, the same scene can be viewed from each of these different angles using **ANGLE**. The recorded angles differ depending on the disc.

1.  Press **ANGLE** during playback. The currently selected angle appears.
2. Repeatedly press **ANGLE** until the desired angle is selected.

Note: This function only works for discs with scenes recorded at different angles.

Using Repeat Play

1.  Press **REPEAT** during playback. Each time you press **REPEAT**, the TV screen displays the repeat mode setting and the disc repeats a chapter or title.

The repeat mode changes between **CHAPTER REPEAT**, **TITLE REPEAT**, and **REPEAT OFF** as you press **REPEAT**.

2. To return to normal play, press **REPEAT** several times until **OFF** appears.

Notes:

- Repeat Play works only with discs for which the elapsed playing time appears in the DVD display window during playback.
- Repeat Play might not work correctly with some DVDs.

Zooming In

Zoom allows you to zoom in and enlarge the picture on the screen to either 4 times (4X) or 16 times (16X) its normal size.

1.  Press **ZOOM** during normal or still playback.
2. To resume normal size, press **ZOOM** to cancel the zoom feature and resume normal playback or still playback.

Notes:

- Some DVDs might not respond to Zoom.
- Zoom does not work on subtitles or menus included on DVD video discs.

Selecting TV Aspect

Select the appropriate screen type according to your TV set. Conventional size screens use a 4:3 aspect ratio, and wide-screens use a 16:9 ratio.

1.  Press **DVD SET UP**.
2. At the setup screen, press **▲** or **▼** to select **TV DISPLAY**, then press **ENTER**.

3. Repeatedly press **ENTER** to select the desired aspect, then press **DVD SET UP**. You must select the type of TV picture (aspect ratio) that corresponds to the type of TV you are connecting to the receiver.

4:3 PS (Pan and Scan) — If you have a conventional TV set and your DVD is not formatted for widescreen viewing, use this setting.

4:3 LB (Letterbox) — If you have a conventional TV set and your DVD is formatted for widescreen viewing, use this setting. All video material not formatted in the Pan and Scan style is played back in the letterbox style. Black bands appear at the top and bottom of the screen.

16:9 WIDE (Widescreen) — If you have a widescreen TV set, use this setting. The DVD plays in full size. (You must also set your widescreen TV to “full size”).

Note: If your DVD is not encoded to allow you to change the aspect ratio, **TV DISPLAY** cannot be changed.

Selecting Digital Audio Out

Each DVD has a variety of audio output options. If you connected a device to the receiver’s digital optical jacks (see “Connecting a Digital (Optical) Audio Device” on Page 9), you might have to change the digital audio output setting. Set the player’s Digital Audio Output according to the type of audio system you use.

1. Press **DVD SET UP**.
2. At the setup screen, press or to select **DIGITAL OUT**.
3. Repeatedly press **ENTER** to select the desired output (**PCM** or **BITSTREAM**), then press **DVD SETUP**.

BITSTREAM — To play DVDs, the digital audio output must be set to **BITSTREAM** for the DVD to use Dolby Digital or DTS modes.

Important: To play audio CDs, you do not have to change **BITSTREAM** to **PCM**; the receiver makes the switch automatically.

PCM (Pulse Code Modulation) — To record audio from the receiver to an MD player or other equipment (see “Recording Audio from the Receiver to Digital Audio Equipment”) set the digital audio output to **PCM**.

Caution: If an active digital audio output signal is supplied to a receiver or other equipment without a corresponding digital decoding capability, a very loud noise might be produced which could permanently damage your speakers.

PLAYING MP3 FILES

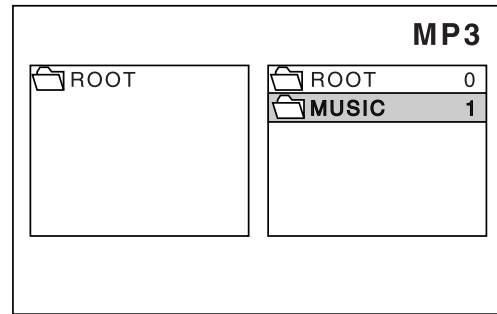

You must turn on the TV during MP3 operation in order to view the on screen display.

1. Load the MP3 disc you want to play in the DVD player. The MP3 menu appears on the TV screen.
2. Press , , , or to select the folder which contains the MP3 files you want to play, and then press **ENTER** or **BAND/▶**. When switching between folders, the screen displays SEARCH.

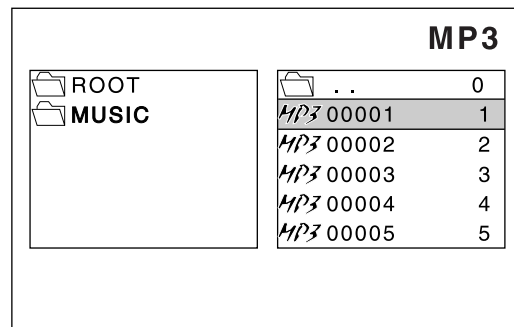

3. Press , , , or to select the MP3 files you want to play. If you want to return to the previous menu, press **FM MODE/■**, and then , , , or .

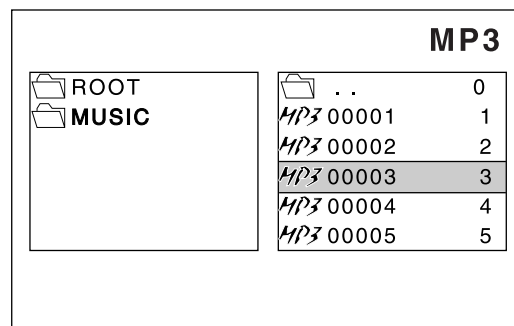

4. Press **ENTER** or **BAND/▶** to play the file. To play the previous file or next file during playback, press **PRESET ◀◀** or **▶▶**. The receiver will not scroll through titles during playback.

Pressing **PRESET ◀◀** or **▶▶** when the DVD player is stopped moves the screen display to the previous or next page.

Notes:

- The resume feature is not available when you play MP3 files.
- This DVD player can play MP3 files recorded at a wide range of bit rates. The recommended bit rate for opti-

mal playback of music files is 128 kbps.

- This DVD player may not play the disc properly if it contains both audio CD and MP3 files.

MP3 Repeat Play

You can repeatedly play MP3 files on a disc.

 Press **REPEAT** during playback or when the player is stopped. Each time you press this button, the repeat mode displayed on the TV screen changes between REPEAT ONE, REPEAT ALL, and REPEAT OFF.

If you select REPEAT ONE the disc repeats a file.

If you select REPEAT ALL the disc repeats a folder.

Note: If the DVD player cannot read an MP3 file properly, ? appears before the file name on the TV screen.

MP3 Random Play







The DVD player can randomly play MP3 files in the folder.





 Press **RANDOM** during playback or when the player is stopped. The TV screen will display either RANDOM ON, or RANDOM OFF.





Pressing **RANDOM** during playback when random mode is already on, halts random playback. RANDOM OFF appears on the TV screen.

Note: **PRESET**  will not perform the skip back to the beginning of a track when RANDOM and REPEAT All are used simultaneously.

USING THE TUNER

1.  or  Press **POWER**. The receiver defaults to the last selected function, which appears in the display panel.
2. Press **TUNER** on the remote, or rotate **FUNCTION** on the receiver until **TUNER** appears in the display.
3. Press **BAND** to select the desired band (**AM** or **FM**).
4. If **PRESET** appears on the receiver's display, press **TUNING MODE** until it disappears. Repeatedly press **PRESET**  or  on the remote, or **TUNING/PRESET**  or  on the receiver to tune in the desired station. When you reach a station, **Tuned** appears above the station number.

*To change the frequency by one step, quickly press and release **PRESET**  or  (or **TUNING/PRESET**  or ).*

*To tune to the next clear frequency, hold down **PRESET**  or  (or **TUNING/PRESET**  or ), then release the button. The system automatically tunes to the next strong station.*

Listening To FM Stereo Broadcasts



















In FM mode, press **FM MODE** to select stereo or mono. When you select the stereo mode, **ST** appears to the right of **Tuned** when the tuner is receiving a stereo station. It goes off when you select mono.

When you listen to very weak FM stereo stations, you might hear higher-than-normal background hiss. Switch to mono to eliminate the hiss.

Presetting Radio Stations

You can preset 30 AM and 30 FM stations regardless of the reception. Tune in the desired stations using auto or manual tuning.





Manual Preset

1.  or  Press **BAND** to select **AM** or **FM**.
2. If **PRESET** appears on the receiver's display, press **TUNING MODE** until it disappears.
3. Repeatedly press **PRESET**  or  (or **TUNING/PRESET**  or  on the receiver) to tune in the desired station.
*To change the frequency by one step, quickly press and release **PRESET**  or  (or **TUNING/PRESET**  or  on the receiver).*
*To tune to the next clear frequency, hold down **PRESET**  or  (or **TUNING/PRESET**  or  on the receiver), then release the button. The system automatically tunes to the next strong station.*
4. Press **MEMORY**. **MEM** flashes for 5 seconds.
5. While **MEM** flashes, press **PRESET**  or  on the remote or **TUNING/PRESET**  or  on the receiver to select the desired preset number.



Note: If **MEM** goes off before you select the desired preset number, press **MEMORY** again (**MEM** flashes again).

6. Press **MEMORY** again or wait until **MEM** stops flashing.
7. Repeat Steps 2–6 to memorize other stations (up to 30 stations for each band). If you store a new station in an occupied memory location, the old station is replaced with the new one.

To store stations on the other band, repeat Steps 1–6, substituting the other band in Step 1.

Note: If you want to store more stations later, you might find that pressing **PRESET**  or  (or **TUNING/PRESET**  or  on the receiver) only moves the tuner to the next preset station (instead of moving the frequency one step). If this happens, press **TUNING MODE** to return to manual tuning (see "Switching Between Preset Stations and Manual Tuning").

Auto Preset









1.  or  Press **BAND** to select the desired band.
2. Hold down **MEMORY** for about 3 seconds.
3. The tuner automatically begins scanning, and stores the first 30 strong signals it receives.
4. Scanning stops automatically after radio stations have been stored in the auto preset memory.







Note: Press **MEMORY** again to stop auto scanning sooner.

To store stations on the other band, repeat Steps 1–4, substituting the other band in Step 1.









Switching Between Preset Stations and Manual Tuning

 or  If you store preset stations, pressing **PRESET**  or  (or **TUNING/PRESET**   or   on the receiver) scrolls through the preset stations, rather than changing the frequency station by station.

To switch to scrolling by individual stations, press **TUNING MODE**, then repeatedly press **PRESET**  or  (or **TUNING/PRESET**   or   on the receiver) quickly to change the frequency by one step. Or hold down **PRESET**  or  to tune to the next clear station.

To switch back to scrolling through the preset stations, press **TUNING MODE**, then repeatedly press **PRESET**  or  (or **TUNING/PRESET**   or   on the receiver) until you reach the desired station.



Listening to Preset Stations

 or  To listen to a radio station stored in memory, press **TUNING MODE** then **PRESET**  or  (or **TUNING/PRESET**   or   on the receiver).

PLAYING AUDIO CDS

You can use the receiver's 3-DVD changer to listen to audio CDs.

Important: You can only use audio CDs with the receiver. CD-ROM, CD-G, photo CD, and CD-i discs can not be played on this player.

1.  or  Press **POWER**. The last selected function appears.
2. Press **DVD/CD**, or rotate **FUNCTION** (on the receiver) until **DVD/CD** appears.
3. On the receiver, press **DISC 1**, **DISC 2**, or **DISC 3** to open the desired drawer.
4. Place the desired CD in the tray. Press the appropriate **DISC** button again to close the drawer. The selected CD's number begins to flash.

Caution: Do not press on the drawers to close them. Doing so can damage the drawers.



Note: If you want to load more than one CD, you can press another **DISC** button. The receiver closes the open drawer and opens the drawer of the **DISC** button you pressed.



5. To play the selected CD, press **PLAY**. The disc icon (at the far left) begins to rotate.
6. To select a different CD, press **DISC SKIP**. The currently selected CD's number blinks and **LOADING** appears. To skip to the next CD, press **DISC SKIP** again while **LOADING** flashes.

Note: If **LOADING** has stopped flashing, you must wait until the CD loads, then press **DISC SKIP** again.



Once the desired CD has loaded, it automatically plays.



7. To pause playback, press **MEMORY/II** (or **PAUSE** on the receiver). To resume playback, press **MEMORY/II** (or **PAUSE**) again or press **BAND/▶** (or **PLAY** on the receiver).



To move forward through a track, hold down **PRESET**  or **TUNING/PRESET**  (on the receiver) for about 2 seconds. Repeat up to two times to increase the fast-forward speed. To resume playback, press **BAND/▶** (or **PLAY**).

To move backward through a track, hold down **PRESET**  or **TUNING/PRESET**  (on the receiver) for about 2 seconds. Repeat up to two times to increase the rewind speed. To resume playback, press **BAND/▶** (or **PLAY**).

Note: At the beginning or end of a track on an audio CD, the scan speed returns to normal.

To skip to the next track on the CD, press **PRESET**  or **TUNING/PRESET**  (on the receiver) once.

To return to the beginning of the current track, press **PRESET**  or **TUNING/PRESET**  (on the receiver).

To return to the previous track, press **PRESET**  or **TUNING/PRESET**  (on the receiver) twice.

To stop playback, press **FM MODE/■** or **STOP** (on the receiver). The disc icon stops rotating, and **RESUME** appears. To resume playback, press **BAND/▶** (or **PLAY**). To stop playback completely, press **FM MODE/■** or **STOP** again.

Continuous Play

When the receiver finishes playing an audio CD, it automatically plays the disc in the next tray.

Repeat Play

Important: You must have a disc in all three trays to use  **DISC ALL** (repeat all discs). Otherwise, the receiver stops when it reaches an empty tray.

The repeat mode changes between (repeat one), **ALL** (repeat all tracks on that disc), **DISC ALL** (repeat all discs), as you press **REPEAT**.

To return to normal play, press **REPEAT** until the icon disappears.

Note: When (repeat one) is on, you cannot skip to another track by pressing **PRESET** or . You must either exit Repeat mode or use the number keys to enter the desired track number.

Programming Tracks

You can program up to 32 tracks for playback in any desired order. This function only operates with audio CDs (not DVDs).

Note: The disc must be recognized by the receiver, so play the disc for a little while after loading, then program it.

1. Press **FM MODE/** twice.
2. Press **PROGRAM**. **01 --** appears.
3. Repeatedly press **DISC SKIP** to select the desired CD (if necessary). The CD number appears to the far right of the display.

Note: To program the CD player to play CDs from multiple trays, you must have a CD in every tray you program the player to use.

4. Use the number keypad to enter the desired track number, then press **ENTER** to program the first desired track. **02 --** appears.
5. Repeat Steps 3–4 to program more tracks.

To exit Program mode and play a CD normally, press **FM MODE/** twice, then press **PROGRAM**. **P-OFF** appears. To return to the programming later, press **FM MODE/** twice, then press **PROGRAM**.

To check the programmed order, press **FM MODE/** . Repeatedly press or to view the programmed order.

To clear the programming, press **FM MODE/** , then press **CLEAR**.

Notes:

- If you try to select more than 32 tracks, **FULL** appears. You cannot program any more tracks.
- If you press **PROGRAM** twice successively while programming, the programming stops and **P-##n** appears.
- Press **BAND/** to start program playback.

Modifying the Program and Adding a Track

1. Press **FM MODE/** twice. You cannot modify the programming in Resume Mode.
2. Repeatedly press or to select the desired programmed track.

To clear the track, press **CLEAR**.

To change the track to another track, use the number keypad to enter the desired track number, then press **ENTER**.

To change the track to a track on another disc, press **DISC SKIP**, enter the number of the desired track, then press **ENTER**.

To add a track, repeatedly press or until you reach the last programmed track. Press again. Enter the number of the desired track, then press **ENTER**.

3. To start program playback again, press **PROGRAM** twice, then **BAND/** .

Note: The programmed contents are lost if you turn off the receiver or change the function to **TUNER**.

Random Play

Important: Random play only works with CDs for which appears on the display next to the rotating disc icon.

1. Begin playing the desired CD.
2. Press **FM MODE/** twice to stop the CD.
3. Press **RANDOM**. **RANDOM** appears next to the disc numbers.
4. Press **BAND/** . The receiver randomly selects tracks.

Using GUI Menu Icons

GUI (Graphic User Interface) menu icons show the current track number and elapsed time of a CD. The elapsed time icon only allows you to view the indicated information. The current track icon allows you to change the track.

Important: You must turn on your television to view the GUI menu icons.

Press **GUI** during playback. Icons of the current track number and the elapsed time appear.

The first icon is the current track icon. You can jump to the desired track number by pressing the number keys and **ENTER**.

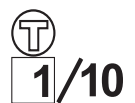



The second icon is the elapsed time icon. It shows the elapsed time. You cannot change it. It is only for viewing.



Note: You cannot use the GUI icons while the CD player is in Program mode.

CONTROLLING A SATELLITE RECEIVER OR CABLE BOX

Note: Make sure you made the correct connections (see “Connecting a Satellite Receiver or Cable Box” on Page 8).

 or  To use a satellite receiver that has analog audio output, press **SAT**, or rotate **FUNCTION** on the receiver. **SAT** appears.



To use a satellite receiver that has digital audio output, press **SAT** twice, or rotate **FUNCTION** on the receiver until **SAT-OPT** appears.

Note: You cannot use **SAT-OPT** if you do not have digital audio output. If you rotate **FUNCTION** to **SAT-OPT** and you do not have digital audio output, **OPT** flashes.

To control the satellite receiver or cable box with the remote control, see “Using the Remote Control to Control Additional Components” on Page 22.

USING THE SLEEP TIMER

You can set the sleep timer to turn off the receiver after a set period of time.

 or  Repeatedly press **SLEEP** to set the sleep timer to the desired time (**10, 20, 30, 40, 50, 60, 70, 80, or 90** minutes or **OFF**). When the desired sleep time appears, let the sleep timer time out (do not press **SLEEP** again). The display dims when the sleep timer is set.

To check the expired sleep time, press **SLEEP** once. The remaining time appears. To continue the sleep time, let it time out. To cancel the sleep timer, press **SLEEP** repeatedly until it turns off.

The receiver turns off when the selected time has expired.

Note: To brighten the display while the sleep timer is on, press **DIMMER** (on the receiver).

USING THE REMOTE CONTROL TO CONTROL ADDITIONAL COMPONENTS

You can set your remote control to control other components such as a VCR, TV, satellite receiver or cable box.

1. Turn on the component to be programmed.
2. Look up the brand and corresponding code(s) in the code list (see “Manufacturer’s Codes” on Page 22).
3. While holding down the appropriate source button (**VCR**, **TV**, or **SAT**) on the remote control, use the number keys to enter the first code from the code list.
4. Release the source button, then press **POWER**. If you have entered the correct code, the component turns off.

If the component does not turn off, repeat steps 3 and 4 and use the next code (if applicable) listed for the brand of your component until the component responds to the remote command.

5. Experiment with the remote control and your components to see which buttons work. If only a few functions operate, repeat Step 4 to see if another code operates more buttons.

Notes:

- To turn on or off the receiver when you select the **VCR**, **SAT**, or **TV** function, press **POWER** twice.
- Once the manufacturer’s code for the TV is set, **MUTE** and **VOLUME +/-** can only be used in **TV** mode.

Cautions:

- This remote control might not operate on all models of the brands shown in the “Manufacturer’s Codes” on Page 22.
- If batteries are removed from the battery compartment of the remote, replace the batteries within 30 minutes or the codes are lost. You must then re-enter all previously programmed codes.
- The buttons on the remote control may not work exactly like the component’s corresponding buttons.

MANUFACTURER’S CODES

TV Codes

Brand	Codes
ABEX	272
ADMIRAL	101
AKAI	102
ALLERON	146
AMTRON	138
AOC	104,105,106,107
AUDIOVOX	138
BELCOR	104
BELL & HOWELL	101, 262
BRADFORD	138
BROCKWOOD	104
CANDLE	104, 106, 108
CELEBRITY	102
CITIZEN	104, 106, 108, 138, 205, 271
COLORTYME	104, 106
CONCERTO	104, 106
CONTEC/CONY	112, 113, 138
CRAIG	138
CROWN	138, 271
CURTIS MATHES	104, 106, 115, 185, 205, 262, 271
CXC	138
DAEWOO	104, 105, 106, 117, 118, 271
DAYTRON	104, 106, 271
DIMENSIA	185
DUMONT	104
ELECTROBAND	102

Brand	Codes
ELECTROHOME	103, 104, 106, 119, 122
EMERSON	104, 106, 112, 124, 125, 126, 127, 128, 129, 130, 131, 132, 134, 135, 136, 138, 139, 141, 142, 146, 262, 271, 279
ENVISION	104, 106
FISHER	148, 149, 151, 262, 280
FUJITSO	146
FUNAI	138, 146
FUTURETEC	138
GE	103, 104, 106, 110, 119, 121, 122, 152, 154, 155, 185, 187, 200, 221, 230, 264, 265, 281
GIBRALTAR	104
GRUNDY	138, 146, 271
HALLMARK	104, 106
HARVARD	138
HITACHI	104, 106, 110, 112, 113, 119, 140, 159, 160, 214, 235, 236, 237, 238, 239, 240, 242, 243, 244, 245, 246, 248, 279
IMA	138
INFINITY	162
JBL	162
JC PENNEY	104, 105, 106, 108, 122, 152, 154, 158, 163, 172, 185, 187, 205, 228, 271, 272, 281
JCB	102
JENSEN	104, 106
JVC	112, 113, 154, 156, 160, 165, 166, 167, 189, 257, 258, 259
KAWASHO	102, 104, 106
KENWOOD	104, 106, 119
KLOSS NOVABEAM	169, 283
KTV	138, 271
LG (GOLDSTAR)	104, 105, 106, 112, 119, 156, 158, 255, 256, 271, 272
LOEWE	162
LUXMAN	104, 106
LXI	106, 149, 162, 172, 185, 262, 281
MAGNAVOX	104, 106, 108, 119, 162, 169, 174, 175, 176, 177, 188, 189, 226, 230, 231, 232, 233, 234, 254, 283, 284
MARANTS	162
MARANTZ	104, 106, 162
MEGATRON	106, 159
MEMOREX	101, 106, 182, 262
MGA	104, 105, 106, 119, 122, 151, 179, 180, 182
MIDLAND	154, 271, 272, 281
MINUTZ	152

Brand	Codes
MITSUBISHI	104, 105, 106, 119, 122, 151, 179, 180, 181, 182, 210, 221, 225
MOTOROLA	103
MTC	104, 105, 106, 205
MULTITECH	138
MULTIVISION	184
NAD	106, 172
NEC	103, 104, 105, 106, 189
NIKKO	106
ONWA	138
ORION	135
PANASONIC	103, 154, 162, 230, 270
PHILCO	103, 104, 105, 106, 108, 112, 119, 162, 169, 174, 175, 177, 283, 284
PHILIPS	103, 104, 108, 112, 119, 162, 169, 174, 175, 176, 186, 187, 188, 189, 230
PILOT	104, 271
PIONEER	104, 106, 190, 191, 192, 279
PORTLAND	104, 105, 106, 271
PRICE CLUB	205
PRISM	154
PROSCAN	185, 281
PROTON	104, 106, 112
PULSER	104
QUASAR	103, 154
RADIOSHACK/ REALISTIC	104, 106, 112, 138, 149, 185, 262, 271, 272
RCA	103, 104, 105, 106, 107, 110, 119, 120, 121, 135, 156, 185, 198, 199, 200, 201, 202, 210, 221, 279, 281, 287, 290
SAMPO	104, 106, 271, 272
SAMSUNG	104, 105, 106, 112, 115, 119, 204, 205, 206, 271, 272
SAMSUX	271
SANYO	104, 109, 148, 149, 180, 207, 208, 210, 262, 280
SCOTCH	106
SCOTT	104, 106, 112, 124, 135, 138, 146
SEARS	104, 106, 113, 119, 146, 148, 149, 151, 166, 172, 185, 209, 210, 262, 280, 281
SHARP	104, 106, 112, 129, 211, 212, 213, 221, 222, 271
SHOGUN	104
SIGNATURE	101
SIMPSON	108
SONY	102
SOUNDESIGN	104, 106, 108, 138, 146
SSS	104, 138
STARLITE	138

Brand	Codes
SUPREME	102
SYLVANIA	104, 106, 108, 119, 162, 169, 174, 175, 176, 177, 188, 283, 284
SYMPHONIC	138
TATUNG	103
TECHNICS	154
TECHWOOD	104, 106, 154
TEKNIKA	104, 105, 106, 108, 112, 113, 138, 146, 176, 182
TELECATION	205, 270, 271
TOSHIBA	149, 172, 189, 205, 209, 210, 217, 218, 221, 260, 262
UNIVERSAL	152, 187
VICTOR	166
VIDTECH	104, 105, 106
WARDS	101, 104, 105, 106, 107, 124, 146, 152, 162, 169, 174, 175, 176, 185, 187, 188, 219, 220, 284
YAMAHA	104, 105, 106, 119
ZENITH	104, 247, 253, 254

VCR Codes

Brand	Codes
ADMIRAL	531
ADVENTURA	426
AIWA	426
AKAI	403, 404, 512, 513
AMERICAN HIGH	421
ASHA	413
AUDIO DYNAMICS	409, 410
AUDIOVOX	414
BEAUMARK	413
BELL & HOWELL	411
CALIX	414
CANDLE	413, 414, 423, 461
CANON	421
CARVER	462
CCE	461
CITIZEN	413, 414, 415, 416, 417, 418
COLORTYME	409
COLT	461
CRAIG	413, 414, 423, 461
CURTIS-MATHES	409, 412, 413, 416, 418, 421, 515
CYBERNEX	413
DAEWOO	415, 417, 426, 428
DBX	409, 410
DIMENSIA	412

Brand	Codes
DYNATECH	426
ELECTROHOME	414, 429
ELECTROPHONIC	414
EMERSON	414, 415, 421, 426, 429, 430, 432, 433, 435, 436, 437, 438, 439, 440, 441, 442, 444, 445, 465, 513, 516, 517, 530
FISHER	405, 411, 419, 423, 448, 449, 450, 451, 518
FUJI	421, 519
FUNAI	426
GARRARD	426
GE	401, 412, 413, 421, 453, 515, 520
GRADIENTE	426
HARLEY DAVIDSON	426
HARMAN KARDON	409
HARWOOD	461
HEADQUARTER	411
HI-Q	423
HITACHI	421, 455, 456, 457, 489, 497, 507, 511, 520, 522
INSTANT REPLAY	421
JC PENNEY	409, 410, 411, 413, 414, 421, 455, 456, 458, 459, 460, 507, 518
JCI	421
JENSEN	455, 456, 511
JVC	409, 410, 411, 418, 420, 421, 458, 462, 468, 477, 511, 523
KENWOOD	409, 410, 411, 416, 418, 456, 511, 523
KLH	461
KODAK	414, 421
LG (GOLDSTAR)	409, 414, 418, 454, 506
LLOYD	426
LOGIK	461
LXI	414
MAGNAVOX	421, 462, 463, 504, 508, 524
MAGNIN	413
MARANTZ	409, 410, 411, 416, 418, 421, 458, 462
MARTA	414
MATSUSHITA	421
MEI	421
MEMOREX	411, 413, 414, 421, 423, 426, 504, 531
MGA	429, 465, 513
MGGNAVOX	421, 449, 462, 504
MGN TECHNOLOGY	413
MIDLAND	453
MINOLTA	455, 456, 507
MINOLTA	455, 456, 507
MINOLTA	455, 456, 507
MINOLTA	455, 456, 507
MITSUBISHI	406, 407, 419, 421, 424, 429, 455, 456, 465, 466, 467, 469, 470, 471, 472, 473, 474, 506, 513, 523

Brand	Codes
MONTGOMERY WARD	531
MOTOROLA	421, 531
MTC	413, 426
MULTITECH	413, 416, 426, 453, 461
NEC	409, 410, 411, 416, 418, 458, 511, 523
NIKKO	414
NOBLEX	413
OLYMPUS	421
OPTIMUS	414, 421, 431, 446, 494, 509, 531
OPTONICA	496
ORION	435
PANASONIC	421, 446, 509, 525, 526, 531
PENTAX	416, 455, 456, 507, 520
PENTEX RESEARCH	418
PHILCO	421, 462, 463
PHILIPS	421, 462, 496, 524
PILOT	414
PIONEER	410, 443, 455, 480, 481, 523
PORTLAND	416, 417
PROSCAN	401, 412
PROTEC	461
PULSAR	504
QUARTER	411
QUARTZ	411
QUASAR	421, 525
RADIOSHACK/ REALISTIC	411, 413, 414, 421, 423, 426, 429, 449, 450, 496, 531
RADIX	414
RANDEX	414
RCA	401, 403, 412, 413, 415, 421, 431, 446, 448, 453, 454, 455, 456, 462, 482, 483, 484, 486, 487, 488, 489, 490, 491, 494, 507, 509, 515, 520, 525, 531
RICOH	528
RUNCO	504
SAMSUNG	413, 415, 433, 453
SANKYO	504, 531
SANSUI	410, 511, 523
SANYO	405, 411, 413, 423
SCOTT	415, 432, 435, 438, 465, 493, 516
SEARS	401, 414, 421, 423, 448, 449, 450, 451, 455, 456, 507, 518
SHARP	417, 429, 431, 494, 495, 496, 531
SHINTOM	404, 456, 46, 498
SHOGUN	413
SIGNATURE	531
SINGER	421, 461, 528

Brand	Codes
SONY	404, 421, 425, 427, 434, 498, 499, 519, 528
STS	421, 507
SYLVANIA	421, 426, 462, 463, 465, 524
SYMPHONIC	426
TANDY	411, 106
TASHIKO	414, 113, 138
TATUNG	458, 511
TEAC	426, 458, 511
TECHNICS	421, 409
TEKNIKA	414, 421, 426
TMK	413
TOSHIBA	415, 449, 451, 455, 465, 493, 506, 516
TOTEVISION	413, 414
UNITECH	413
VECTOR RESEARCH	409, 410, 415, 416, 513
VIDEOSONIC	413
WARDS	413, 414, 415, 421, 423, 426, 429, 455, 456, 461, 496, 501, 502, 503, 507, 516, 531
XR-1000	421, 426, 461
YAMAHA	409, 410, 411, 418, 458, 511
ZENITH	404, 498, 504, 519, 528

Cable Codes

Brand	Codes
ABC	702, 703, 704, 705, 706, 709, 753
ANTRONIX	708, 709
ARCHER	708, 709, 710, 711
CABLETENNA	708
CABLEVIEW	708
CENTURY	711
CITIZEN	711
COLOUR VOICE	712, 713
COMTRONICS	714, 715
CONTEC	716
EASTERN	717
GARRARD	711
GC ELECTRONICS	709
GEMINI	718, 719, 749
GENERAL INSTRUMENTS	703
GRADIENT	781
HAMLIN	720, 721, 722, 735, 745
HITACHI	703
HYTEX	702
JASCO	711

Brand	Codes
JERROLD	703, 705, 707, 714, 718, 723, 724, 746, 753, 782, 783, 784, 785, 788, 789, 790, 791, 792
LG (GOLDSTAR)	770, 771, 779, 780
MAGNAVOX	725
MEMOREX	726
MOVIE TIME	702, 727, 728
NSC	702, 727, 728
OAK	702, 727, 728
PANASONIC	748, 752
PARAGON	726
PHILIPS	711, 712, 713, 714, 725, 730, 731, 732
PIONEER	701, 733, 734, 742
PULSAR	726
RADIOSHACK	770, 771, 779, 780
RCA	747, 749, 752
REALISTIC	709, 749
REGAL	722, 735
REGENCY	717
REMBRANDT	703
RUNCO	726
S.A	737, 738, 786, 787
SAMSUNG	714, 734
SCIENTIFIC ATLANTA	706, 736, 737, 738
SIGNAL	714, 718
SIGNATURE	703
SL MARX	714, 525
SPRUCER	752
STARCOM	707, 718, 753
STARGATE	714, 718
STARQUEST	718
TANDY	740
TELEVIEW	714
TOCOM	704, 723, 741
TOSHIBA	726
TSUA	718
TV86	727
UNIKA	708, 709, 711
UNITED ARTISTS	702
UNITED CABLE	753, 713
UNIVERSAL	708, 709, 710, 711
VIDEOWAY	744
VIEWSTAR	715, 725, 727, 740
ZENITH	726, 750, 751, 774, 777

Satellite System Codes

Brand	Codes
CHAPPARAL	756, 757
DRAKE	758, 759
EHOSTAR	743
GE	778
GENERAL INSTRUMENTS	760, 761, 762
PANASONIC	757
PIONEER	739
PRIMESTAR DBS	776
PROSCAN	778
RCA	754, 755, 778
REALISTIC	763
SONY	772, 725, 727, 740
STS1	764
STS2	765
STS3	766
STS4	767
TOSHIBA	768
UNIDEN	769

TROUBLESHOOTING

This receiver has been manufactured to the specifications of RadioShack and is covered by a limited warranty from RadioShack. If your receiver is not operating as it should, take it to your local RadioShack store or call 1-800-THE-SHACK for assistance.

If you think that there is something wrong with this component, check the points below. Investigate the other components and electrical appliances being used. Sometimes the trouble may reside in another component.

Symptom	Cause	Remedy
No power.	The power cord is disconnected.	Plug the power cord into the wall outlet securely.
The power is on, but the DVD player does not work.	No disc is inserted.	Insert a disc. (Check that the DVD or audio CD indicator in the DVD display is lit.)
No picture.	The TV is not set to receive DVD signal output.	Select the appropriate video input mode on the TV so the picture from the DVD player appears on the TV screen.
	The video cable is not connected securely.	Connect the video cable into the jacks securely.
	The connected TV power is turned off.	Turn on the TV.
The playback picture is poor.	The disc is dirty.	Clean the disc.
The DVD player does not start playback.	No disc is inserted.	Insert a disc. (Check that the DVD or CD indicator in the display panel is lit.)
	The DVD player cannot read the disc because it is damaged or an incorrect type (for example, a CD-i).	Check the disc type, color system and regional code. Check for any scratches or smudges on the disc. Insert a readable disc.
	The disc is placed upside down.	Place the disc with the playback side down.
	The disc is not placed within the guide.	Place the disc on the disc tray correctly inside the guide.
	The disc is dirty.	Clean the disc.
	A menu appears on the TV screen.	Press SETUP to turn off the menu screen.
	The rating level is set.	Cancel the rating function or change the rating level.
The remote control does not work properly.	The remote control is not pointed at the remote sensor of the receiver.	Point the remote control at the remote sensor of the receiver.
	The remote control is too far from the receiver.	Operate the remote control within about 23 feet (7 m) of the receiver.
	There is an obstacle between the remote control and the DVD player.	Remove the obstacle.
	The remote's batteries are low.	Replace the batteries.
The receiver does not respond when the buttons are pressed.	Static electricity caused by dry air.	Disconnect the power plug from the outlet, then re-insert the plug.
No sound is output when a function is selected.	Improper connections.	Make sure the component is connected correctly.
	Sound is muted.	Press the remote's MUTE .
	The volume is turned down.	Adjust VOLUME .
No image is output when a function is selected.	Improper connections.	Make sure the component is connected correctly.
	The input source is not properly selected.	Press the correct function button.

Symptom	Cause	Remedy
Considerable noise in radio broadcasts.	Incorrect frequency.	Tune in the correct frequency.
	The antenna is not connected.	Connect the antenna.
	RF (AC-3) and/or digital cables are near the antenna terminals and wires.	Route RF (AC-3) and digital cables away from the antenna terminals and wires.
	(For FM) The FM antenna is not fully extended or is poorly positioned.	Fully extend the FM wire antenna, position for best reception, and secure to a wall.
	(For FM) The signal is weak.	Connect an outdoor FM antenna.
	(For AM) The AM antenna is poorly positioned.	Adjust the direction and position for best reception.
	(For AM) The signal is weak.	Connect an additional internal or external AM antenna.
Interference caused by other equipment (for example, fluorescent lights, motors).		Turn off the equipment causing the noise or move it away from the receiver.
		Place the antenna farther away from the equipment causing the noise.
Broadcast stations cannot be selected automatically.	The signals are weak.	Connect an outdoor antenna.
The display is dark.	The dimmer or sleep timer is on.	Press DIMMER again.
When listening to the music in stereo, left/right speakers sounds are reversed.	Speakers are incorrectly connected.	Check or reconnect.
Low hum or buzz sound.	Power line of a fluorescent light or other device is installed near the receiver.	Place the receiver as far away as possible from electric devices that cause interference.
Sound is only heard from one channel.	One of the input cords is disconnected.	Connect the input cords securely.
	The channel level is set to one side.	Adjust the channel level.
Sound cuts off or there is no sound even though power is on.	Speaker impedance is less than prescribed for this receiver.	After turning off the power and then turning it on again, reduce the volume or change to the correct 6-ohm speakers.
Low bass response.	Speaker polarity(+/-) is reversed.	Check all speakers for correct polarity.
No sound from the surround speakers.	Surround Mode is set to STEREO .	Set the mode to the desired surround mode position.
	Source being played is not recorded or broadcast in surround sound.	Use surround mode.
	One or more surround speaker wires is not making a good connection.	Check all surround speaker wires for good connection.
No sound from the center speaker.	Surround Mode is not set to DTS , DOLBY DIGITAL , or DOLBY PRO LOGIC .	Set Surround Mode to DTS , DOLBY DIGITAL , or DOLBY PRO LOGIC .

CARE

Keep the receiver dry; if it gets wet, wipe it dry immediately. Use and store the receiver only in normal temperature environments. Handle the receiver carefully; do not drop it. Keep the receiver away from dust and dirt, and wipe it with a damp cloth occasionally to keep it looking new.

Modifying or tampering with the receiver's internal components can cause a malfunction and might invalidate its warranty and void your FCC authorization to operate it. If your

receiver is not performing as it should, take it to your local RadioShack store for assistance.

Caution: You might permanently damage your speakers by cleaning them with a vacuum cleaner. Use a feather duster or a soft loose cloth instead.

Using Discs

When using discs, you must always take the following precautions:

- Do not place discs on top of the receiver.
- Do not touch the playback side of the disc.
- Do not attach paper or tape to discs.
- Do not store discs in a place subject to direct sunlight or near heat sources.
- Do not store discs in places subject to moisture and dust such as a bathroom or near a humidifier.
- Store discs vertically in a case. Stacking or placing objects on discs outside of their case may cause warping.

Cleaning Discs

Fingerprints and dust on the disc cause picture and sound deterioration. Wipe the disc from the center outward with a soft cloth. Always keep the disc clean. If you cannot wipe off the dust with a soft cloth, wipe the disc lightly with a slightly moistened soft cloth and finish with a dry cloth.

Do not use any type of solvents such as thinner, benzene, commercially available cleaners or anti-static spray for vinyl LPs. They might damage the disc.

SPECIFICATIONS

Amplifier Section

Output Power (6 ohms, 40 Hz — 20 kHz, 0.9% T.H.D): Stereo Front L/R (2 Channel Driven) 100W × 2ch

Output Power (6 ohms, 1 kHz, 0.9% T.H.D)

Front L/R (2 Channel Driven)	100 W × 2ch
Center (1 Channel Driven)	100 W × 1ch
Surround L/R (2 Channel Driven)	100 W × 2ch
Subwoofer (1 Channel Driven)	100 W × 1ch

Distortion at 1 kHz, 100 W

Front L/R	< 0.9%
Center/Subwoofer	< 0.9%
Surround L/R	< 0.9%

S/N Ratio (IHF-A Weighted)

STEREO	> 80 dB
--------------	---------

S/N Ratio (IHF-A Weighted, -20dB FS)

SURROUND Front	> 65 dB
SURROUND Center	> 65 dB
SURROUND Rear	> 65 dB

Frequency Response

Front L/R (Large)	10 — 20 kHz, -3 dB/+1 dB
Center (Large)	10 — 20 kHz, -3 dB/+1 dB
Surround L/R (Large)	10 — 20 kHz, -3 dB/+1 dB
Subwoofer	10 — 100 Hz, -3 dB

Tone Control

Bass (100 Hz)	+/-10 dB
Treble (10 kHz)	+/-10 dB

Channel Separation

STEREO	> 55 dB
Dolby Digital	> 45 dB

Tuner Section

(FM) Frequency Range 87.5 — 108 MHz

(FM) Sensitivity

Mono (THD 3%)	15 µV/m, EMF
---------------------	--------------

(FM) Distortion (15 kHz LPF on)

Mono	< 0.4%
Stereo	< 0.5%

(FM) S/N Ratio

Mono	> 68 dB
Stereo	> 63 dB

(FM) Frequency Response 20 — 15 kHz, -3 dB

(AM) Frequency Range 520 — 1710 kHz

(AM) Sensitivity (Loop Antenna) 600 μ V/m
 (AM) Selectivity, +/- 10K > 25 dB
 (AM) S/N Ratio..... > 40 dB

Video Section

Output Level 1.0 V (p-p), 75 ohm
 S-Video Y-Output Level 1.0 V(p-p), 75 ohm
 S-Video C-Output Level 286 mV(p-p), 75 ohm
 S/N Ratio > 45 dB

Component Video
 Y-Output Level 1.0 V (p-p), 75 ohm
 Cb-Output Level 525 mV (p-p), 75 ohm
 Cr-Output Level 525 mV (p-p), 75 ohm

Speaker Section

Type
 Front Two Way, Magnetically Shielded Type \times 2
 Center..... Two Way, Magnetically Shielded Type \times 1
 Surround Two Way Type \times 2
 Subwoofer One Way Type \times 1

Impedance 6 ohm
 Power Handling Capacity..... 100 Watts Max

Miscellaneous

Power Requirement..... AC 120 V, 60 Hz
 Power Consumption 3.2 A
 Weight 37 lb 1 oz
 (16.7 kg)

Dimension (WHD) $16^{15}/_{16} \times 5^8/_{16} \times 15^{12}/_{16}$ inches
 (430 \times 140 \times 400 mm)

Accessories **Indoor FM Antenna (T Type)**
 Adapter for FM Antenna
 AM Loop Antenna
 Owner's Manual
 Universal Remote Unit
 Audio/Video Wire
 Six (6) Speaker Wires

Specifications are typical; individual units might vary. Specifications are subject to change and improvement without notice.

SETTING A RATING LEVEL AND PASSWORD

You can prohibit the playing of specified DVDs which are unsuitable for children. Some DVD discs contain a restriction level which enables parents to remove scenes or prevent playback of discs by children. Your DVD player has a password device designed to prevent children from changing the level.

Note: Remove this page and store it in a safe location where children cannot find it.

SELECTING A RATING LEVEL

Your DVD player has eight rating level settings. Level 1 provides the strictest viewing restrictions. Restrictions decrease as the level number increases.

Note: If your DVD is not encoded with a rating, the Rating Level feature does not work.

1. Press **DVD SET UP**.
2. At the setup screen, press **▲** or **▼** to select **RATING**, then press **ENTER**.
3. Enter a password and press **ENTER**.
4. Repeatedly press **ENTER** to select the desired level.

You cannot play DVD video discs rated higher than the level you selected unless you cancel the parental lock function. For example, when you select level 7, discs rated higher than level 7 are blocked and cannot be played.

5. Press **DVD SET UP** to exit.

Important: Some DVDs prompt you for a password if they have a higher rating than the level you set. If you get this prompt, enter your password. DVDs that do not have the prompt display **PARENTAL VIOLATION**. You reset the rating level to a higher level before you can play the desired DVD (see “Selecting a Rating Level”).

Notes:

- Some DVD discs are not encoded with a rating though the movie rating is printed on the disc jacket. The rating level feature does not work for such discs.
- If you change the level and enter a password, playback of all DVDs with ratings higher than your selection will be blocked, unless you enter the correct password again. For example: if you change the level to 5, the DVD player will not play discs with ratings of 6, 7, or 8 unless the correct password is entered from the remote control.

SETTING A PASSWORD

If you change the rating level to 7 or lower, you must enter a 4-digit password to access playback of discs with higher ratings.

To set this password, follow these steps.

1. Press **DVD SET UP**.
2. At the setup screen, press **▼** to select **PASSWORD**, then press **ENTER**.
3. Type a 4-digit password into **OLD**. (For example, 1234).
4. Type a new 4-digit password into **NEW** then press **ENTER**.

Important: Do not forget your password.

Clearing Your Password

If you forget your password, you can clear the current password.

At the **SETUP** screen, press **▼** to select **RATING**, then press **ENTER**.

Enter the default password (2580), then press **ENTER**. Your 4-digit password is cleared.

To set a new password, follow the Steps in “Setting a Password”.

Limited One-Year Warranty

This product is warranted by RadioShack against manufacturing defects in material and workmanship under normal use for one (1) year from the date of purchase from RadioShack company-owned stores and authorized RadioShack franchisees and dealers. EXCEPT AS PROVIDED HEREIN, RadioShack MAKES NO EXPRESS WARRANTIES AND ANY IMPLIED WARRANTIES, INCLUDING THOSE OF MERCHANTABILITY AND FITNESS FOR A PARTICULAR PURPOSE, ARE LIMITED IN DURATION TO THE DURATION OF THE WRITTEN LIMITED WARRANTIES CONTAINED HEREIN. EXCEPT AS PROVIDED HEREIN, RadioShack SHALL HAVE NO LIABILITY OR RESPONSIBILITY TO CUSTOMER OR ANY OTHER PERSON OR ENTITY WITH RESPECT TO ANY LIABILITY, LOSS OR DAMAGE CAUSED DIRECTLY OR INDIRECTLY BY USE OR PERFORMANCE OF THE PRODUCT OR ARISING OUT OF ANY BREACH OF THIS WARRANTY, INCLUDING, BUT NOT LIMITED TO, ANY DAMAGES RESULTING FROM INCONVENIENCE, LOSS OF TIME, DATA, PROPERTY, REVENUE, OR PROFIT OR ANY INDIRECT, SPECIAL, INCIDENTAL, OR CONSEQUENTIAL DAMAGES, EVEN IF RadioShack HAS BEEN ADVISED OF THE POSSIBILITY OF SUCH DAMAGES.

Some states do not allow limitations on how long an implied warranty lasts or the exclusion or limitation of incidental or consequential damages, so the above limitations or exclusions may not apply to you.

In the event of a product defect during the warranty period, take the product and the RadioShack sales receipt as proof of purchase date to any RadioShack store. RadioShack will, at its option, unless otherwise provided by law: (a) correct the defect by product repair without charge for parts and labor; (b) replace the product with one of the same or similar design; or (c) refund the purchase price. All replaced parts and products, and products on which a refund is made, become the property of RadioShack. New or reconditioned parts and products may be used in the performance of warranty service. Repaired or replaced parts and products are warranted for the remainder of the original warranty period. You will be charged for repair or replacement of the product made after the expiration of the warranty period.

This warranty does not cover: (a) damage or failure caused by or attributable to acts of God, abuse, accident, misuse, improper or abnormal usage, failure to follow instructions, improper installation or maintenance, alteration, lightning or other incidence of excess voltage or current; (b) any repairs other than those provided by a RadioShack Authorized Service Facility; (c) consumables such as fuses or batteries; (d) cosmetic damage; (e) transportation, shipping or insurance costs; or (f) costs of product removal, installation, set-up service adjustment or reinstallation.

This warranty gives you specific legal rights, and you may also have other rights which vary from state to state.

RadioShack Customer Relations, 200 Taylor Street, 6th Floor, Fort Worth, TX 76102

12/99