

HITACHI

Inspire the Next

DVD HOME THEATER SYSTEM

MODEL

DV-S522U

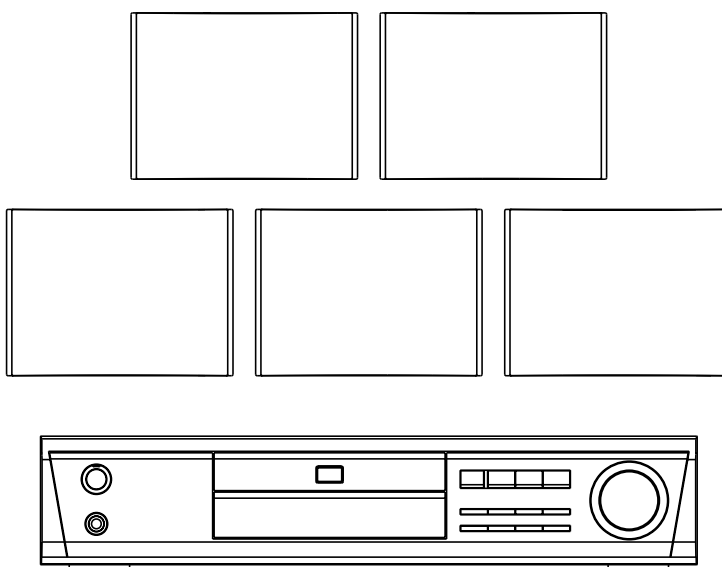
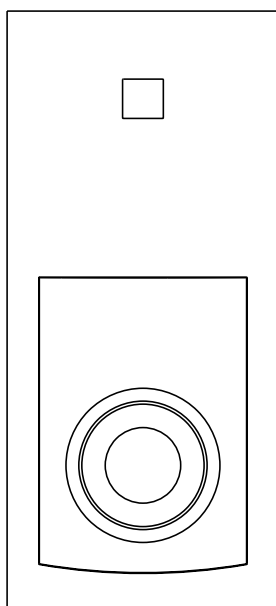

Instruction manual

To obtain the best performance and ensure years of trouble-free use, please read this instruction manual completely.

Manual de instrucciones

Para obtener el mejor funcionamiento y asegurar años de uso libre de problemas, lea cuidadosamente este manual de instrucciones.

ENGLISH

ESPAÑOL

CONTENTS

Accessories	E2	Frame by Frame Advance Playback [DVD] [Video CD] ...	E24
Safety Certification	E3	Picture Zoom [DVD] [Video CD]	E24
For Safe and Efficient Operation	E3	Viewing from a Desired Camera Angle	
Controls	E4	(Multi-Angle) [DVD]	E25
Multi-Brand TV Remote Control	E5	Angle Replay	E25
Basic Connections	E7	Repeat Playback	E25
Speaker Connections	E7	Programmed Playback [Video CD] [CD]	E26
Speaker Placement	E8	Selecting Subtitle Language [DVD]	E27
Antenna Connections	E9	Selecting Audio Soundtrack Language	
Conventional TV Connections	E10	(Multi-Language) [DVD]	E27
Progressive-scan TV Connections	E12	Selecting On-Screen Information	E28
Additional Connection Examples	E13	MP3 CD Operation	E29
Power Supply	E13	MP3 CD Information	E29
Adjusting the Clock	E14	MP3 CD Playback	E29
Before Operation	E15	Stopping Playback	E30
Common Operation	E15	Pause	E30
Selecting the Surround Mode	E16	File Skip	E30
Adjusting the Speaker Volume Level	E17	Repeat Playback	E30
Playable Discs	E18	Initial Settings	E31
Disc Playback	E19	Common Procedures of Initial Settings	E31
Preparations	E19	Language	E31
Basic Playback	E19	Display	E31
Stopping Playback	E20	Speaker	E32
Continuing Playback from Where You Stopped		Parental	E32
Watching (LAST MEMO PLAY), for DVD only	E20	Language Code List	E33
Selecting a DVD Menu	E21	Enjoying Video Sources	E34
Selecting a Top Menu (Title Menu) [DVD]	E21	Listening to the Radio	E34
Return button (RETURN) for Video CD	E21	Automatic/Manual Tuning	E34
Chapter (Track) Skip	E22	To Preset Stations	E34
Title Search [DVD]	E22	Listening to Preset Stations	E35
Chapter Search [DVD]	E22	Timer Operation (Using the Remote Control)	E36
Time Search [DVD]	E22	Using the Wake Up Timer	E36
Time Search [Video CD] [CD]	E23	Using the Sleep Timer	E37
Track Search [Video CD] [CD]	E23	Maintenance	E37
Fast Playback	E23	Troubleshooting Guide	E38
Slow Motion Playback	E24	Specifications	E39
Still Picture (Pause)	E24		

Please Read This Manual.

Because DVD is a new technology, we recommend that you read this manual carefully before connecting your DVD Home Theater System and operating it for the first time.

Keep the manual in a safe place for future reference.

IMPORTANT INFORMATION:

To connect this DVD Home Theater System to a TV, TV must have a Video input jack (RCA-type) at least. You cannot connect it to an antenna terminal of TV.



CAUTION

RISK OF ELECTRIC SHOCK
DO NOT OPEN



CAUTION: TO PREVENT THE RISK OF ELECTRIC SHOCK, DO NOT REMOVE COVER (OR BACK). NO USER-SERVICEABLE PARTS INSIDE. REFER SERVICING TO QUALIFIED SERVICE PERSONNEL.



This symbol indicates that dangerous voltage constituting a risk of electric shock is present within this unit.



This symbol indicates that there are important operating and maintenance instructions in the literature accompanying this unit.

WARNING: TO PREVENT FIRE OR SHOCK HAZARD, DO NOT EXPOSE THIS APPLIANCE TO RAIN OR MOISTURE.

CAUTION: TO PREVENT ELECTRIC SHOCK, MATCH WIDE BLADE OF POWER PLUG TO WIDE SLOT OF AC OUTLET AND FULLY INSERT.

ATTENTION: POUR ÉVITER LES CHOC ÉLECTRIQUES, INTRODUIRE LA LAME LA PLUS LARGE DE LA FICHE DANS LA BORNE CORRESPONDANTE DE LA PRISE ET POUSSER JUSQU' AU FOND.

WARNING: UNAUTHORIZED RECORDING OF COPYRIGHTED MATERIAL MAY VIOLATE APPLICABLE COPYRIGHT LAWS. THE MANUFACTURER ASSUMES NO RESPONSIBILITY FOR UNAUTHORIZED DUPLICATION, USE OR OTHER ACTS WHICH INFRINGE UPON THE RIGHTS OF COPYRIGHT OWNERS.

ACCESSORIES



DV-RM522 wireless remote control

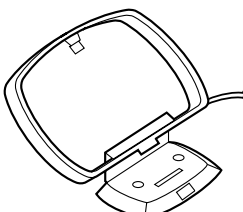

AM loop antenna

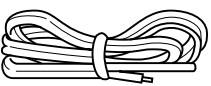

FM indoor antenna lead wire

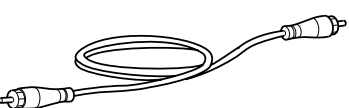

Video cable

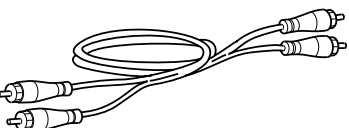

Audio cable



Front right speaker cable
Length: Approx. 20 feet
(Black and Red)

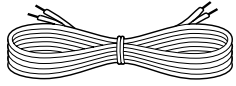

Front left speaker cable
Length: Approx. 20 feet
(Black and Blue)

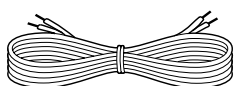

Front center speaker cable
Length: Approx. 20 feet
(Black and Green)



Surround right speaker cable
Length: Approx. 20 feet
(Black and Orange)

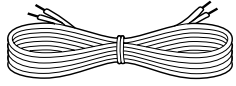

Surround left speaker cable
Length: Approx. 20 feet
(Black and Gray)



Subwoofer cable
Length: Approx. 20 feet
(Black and Brown)

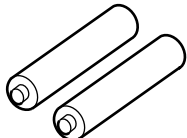

AA size battery (manganese)
(1.5 volt)
Quantity: 1 pair

SAFETY CERTIFICATION

This unit is made and tested to meet exacting safety standards. It meets UL, CSA and FCC requirements and complies with safety performance standards of the U.S. Department of Health and Human Services.

CAUTION - USE OF CONTROLS OR ADJUSTMENTS OR PERFORMANCE OF PROCEDURES OTHER THAN THOSE SPECIFIED HEREIN MAY RESULT IN HAZARDOUS RADIATION EXPOSURE.

THIS UNIT SHOULD NOT BE ADJUSTED OR REPAIRED BY ANYONE EXCEPT PROPERLY QUALIFIED SERVICE PERSONNEL.

FCC INFORMATION

This device complies with Part 15 of the FCC Rules. Operation is subject to the following two conditions: (1) This device may not cause harmful interference, and (2) this device must accept any interference received, including interference that may cause undesired operation.

CAUTION:

Changes or modifications not expressly approved by Hitachi may void the user's authority to operate this equipment.

NOTE:

This equipment has been tested and found to comply with the limits for a Class B digital device, pursuant to Part 15 of the FCC Rules. These limits are designed to provide reasonable protection against harmful interference in a residential installation. This equipment generates, uses and can radiate radio frequency energy and, if not installed and used in accordance with the instructions, may cause harmful interference to radio communications. However, there is no guarantee that interference will not occur in a particular installation. If this equipment does cause harmful interference to radio or television reception, which can be determined by turning the equipment off and on, the user is encouraged to try to correct the interference by one or more of the following measures:

- Reorient or relocate the receiving antenna.
- Increase the separation between the equipment and receiver.
- Connect the equipment into an outlet on a circuit different from that to which the receiver is connected.
- Consult the dealer or an experienced radio/TV technician for help.

THIS CLASS B DIGITAL APPARATUS MEETS ALL REQUIREMENTS OF THE CANADIAN INTERFERENCE-CAUSING EQUIPMENT REGULATIONS.

FOR SAFE AND EFFICIENT OPERATION

- Do not damage the power cord.
- When not in use, disconnect the power cord from the outlet. Grasp the plug, not the cord, when disconnecting the unit.
- If water should enter the unit, electrical shock or a malfunction may result. Use in an area where there is low humidity and little dust.
- Do not disassemble or alter the unit in any way.
- Do not use the unit in areas where extremes in temperature occur (below 40°F (5°C) or exceeding 95°F (35°C)), or where it may be exposed to direct sunlight.
- Because of the DVD video player extremely low noise and wide dynamic range, there is a tendency to set the volume on the amplifier higher than necessary. Doing so may produce an excessively high output from the amplifier which can cause damage to your speakers. Please be careful in this regard.
- Sudden changes in the surrounding temperature can cause dew to form on the optical pickup lens inside the unit. Under this condition the unit may be unable to operate properly. If this should occur, remove the disc and allow the unit to adjust to the surrounding temperature.
- **When carrying the unit, be sure to remove a disc which may be inside and turn the power off. Then unplug the power cord from the AC outlet after 10 seconds. Carrying the unit with a disc inside may damage the disc and/or the unit.**

Do not subject the unit to vibrations or physical shock, such as dropping. If playback has stopped for these reasons,

1. Press the POWER/STANDBY button to turn the power off.
2. Wait for at least 10 seconds.
3. Press the POWER/STANDBY button again to turn the power on.

CAUTION:

Placing the unit in a well ventilated area is strongly recommended.

Do not place any object on the top of the unit.

Do not block ventilation holes.

The cabinet of the unit warms up when it is used for a long time, but it is not a malfunction.

Press [▲ OPEN/CLOSE] on the unit when closing the disc tray. Do not push the disc tray.

WHAT TO DO IF...

If the operation of the unit or display is not normal, even though the appropriate buttons have been pressed.

1. Disconnect the power cord.
2. While pressing both BASS and SOUND buttons at the same time, connect the power cord.
"RESET" briefly appears on the display.
3. Press the desired function button.

Note:

If the unit still does not operate correctly, please contact your nearest Hitachi Authorized Service Facility.

CONTROLS

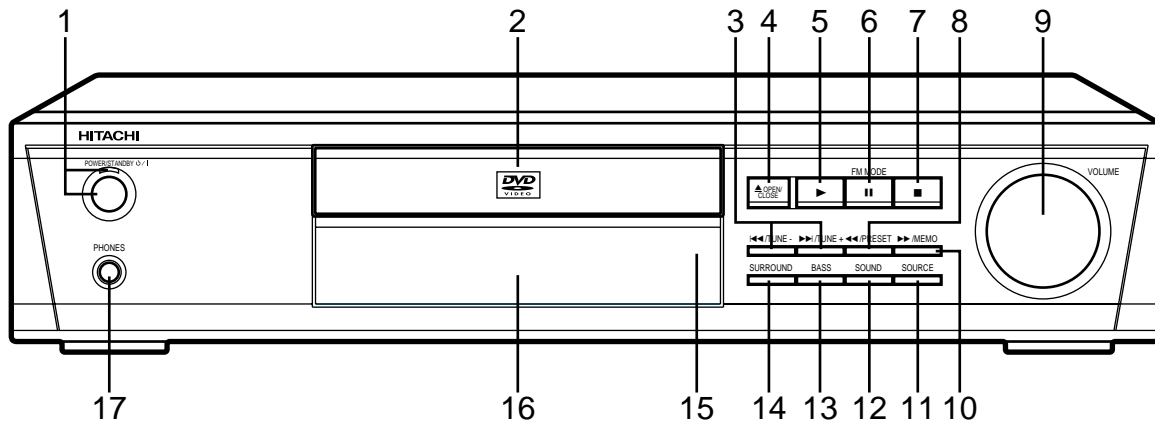

- | | |
|--|---|
| 1. Power button/Standby indicator (POWER/STANDBY \odot/I) | 10. Forward/Memory button ($\blacktriangleright\blacktriangleright$ /MEMO) |
| 2. Disc tray | 11. Source select button (SOURCE) |
| 3. Skip/Next/Previous/Tuning buttons ($\blacktriangleleft\blacktriangleleft$ /TUNE-, $\blacktriangleright\blacktriangleright$ /TUNE+) | 12. Sound preset button (SOUND) |
| 4. Open/Close button (\blacktriangle OPEN/CLOSE) | 13. Bass button (BASS) |
| 5. Play button (\blacktriangleright) | 14. Surround button (SURROUND) |
| 6. FM mode/Pause/Step button (FM MODE/) | 15. Remote sensor |
| 7. Stop button (\blacksquare) | 16. FL display |
| 8. Reverse/Preset button ($\blacktriangleleft\blacktriangleleft$ /PRESET) | 17. Headphone jack (PHONES) |
| 9. Volume control (VOLUME) | |

FL display

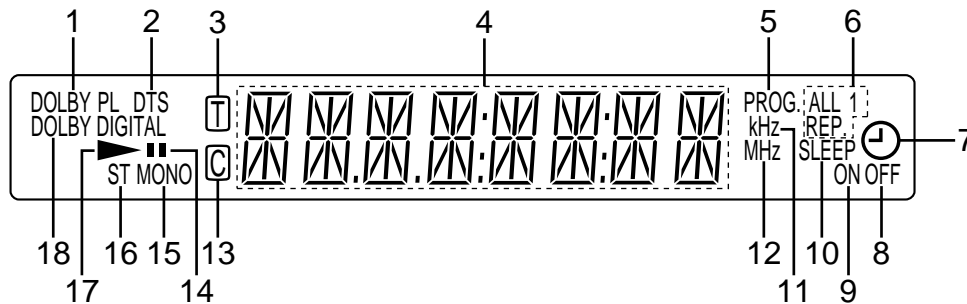

- | | |
|--|--|
| 1. Dolby Pro Logic indicator (DOLBY PL) | 11. Kilohertz indicator (kHz) |
| 2. DTS indicator (DTS) | 12. Megahertz indicator (MHz) |
| 3. Title and Track indicator (T) | 13. Chapter indicator (C) |
| 4. Message or number indicators (Title, chapter, track, playing time or other information) | 14. Pause indicator () |
| 5. Program indicator (PROG.) | 15. FM mono indicator (MONO) |
| 6. Repeat mode indicators (ALL, 1, REP.) | 16. FM stereo indicator (ST) |
| 7. Timer indicator (\odot) | 17. Play indicator (\blacktriangleright) |
| 8. Timer off indicator (OFF) | 18. Dolby Digital indicator (DOLBY DIGITAL) |
| 9. Timer on indicator (ON) | |
| 10. Sleep indicator (SLEEP) | |

“DTS” and “DTS Digital Surround” are registered trademarks of Digital Theater Systems, Inc.

Manufactured under license from Dolby Laboratories. “Dolby”, “Pro Logic” and the double-D symbol are trademarks of Dolby Laboratories.

MULTI-BRAND TV REMOTE CONTROL

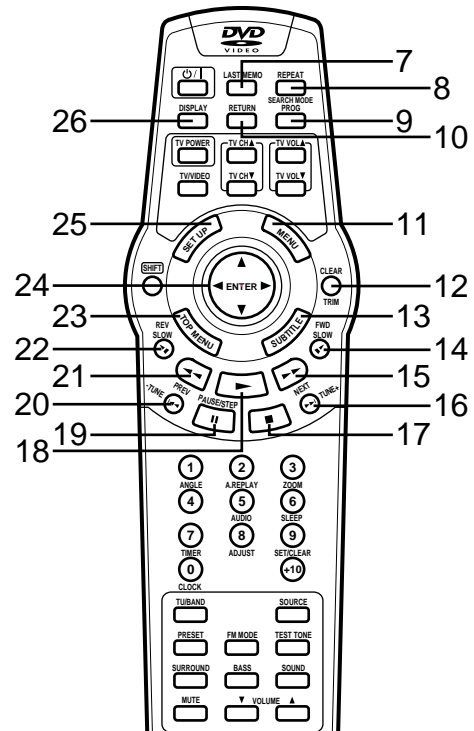
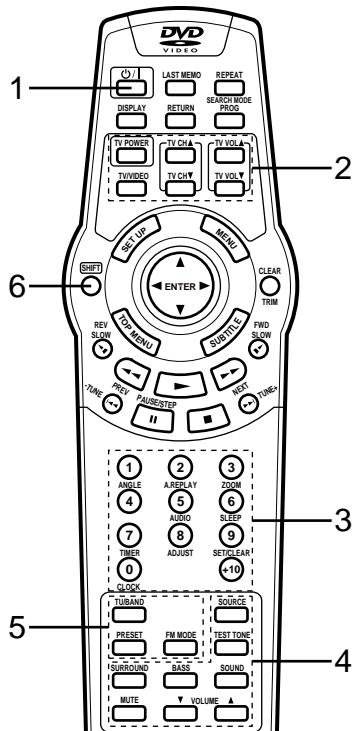

1. Power button (⏻/⏻)
2. TV control buttons
Power button (TV POWER)
TV/VIDEO select button (TV/VIDEO)
Channel scanning buttons (TV CH ▲, TV CH ▼)
Volume buttons (TV VOL ▲, TV VOL ▼)
3. Number and other function buttons
These buttons are used as number buttons and as function buttons of each name.
 - When using as a number button, press the appropriate button directly.
 - When using as a function button of each name, press the appropriate button while holding the SHIFT button down.
 Number buttons (1 – 9, 0, +10)
 Angle button (ANGLE)
 Angle replay button (A.REPLAY)
 Zoom button (ZOOM)
 Audio button (AUDIO)
 Sleep button (SLEEP)
 Timer button (TIMER)
 Adjust button (ADJUST)
 Set/Clear button (SET/CLEAR)
 Clock button (CLOCK)
4. Amplifier controls
Source select button (SOURCE)
Test tone button (TEST TONE)
Surround button (SURROUND)
Bass button (BASS)
Sound preset button (SOUND)
Muting button (MUTE)
Volume buttons (▼ VOLUME ▲)
5. Tuner controls
Tuner function/Band select button (TU/BAND)
Preset tuning button (PRESET)
FM mode button (FM MODE)
6. Shift button (SHIFT)

7. Last memory button (LAST MEMO)
8. Repeat/Search mode button (REPEAT/SEARCH MODE)
Note:
At Search mode, press the button while holding the SHIFT button down.
9. Program button (PROG)
10. Return button (RETURN)
11. Menu button (MENU)
12. Clear/Trim button (CLEAR/TRIM)
Note:
At Trimming mode, press the button while holding the SHIFT button down. (See Page E17.)
13. Subtitle button (SUBTITLE)
14. Forward slow button (FWD SLOW)
15. Forward button (▶▶)
16. Skip/Next/Tuning button (NEXT/TUNE+)
Note:
This button is also used at the clock setting.
17. Stop button (■)
18. Play button (▶)
19. Pause/Step button (PAUSE/STEP)
20. Skip/Previous/Tuning button (PREV/-TUNE)
Note:
This button is also used at the clock setting.
21. Reverse button (◀◀)
22. Reverse slow button (REV SLOW)
23. Top menu button (TOP MENU)
24. Joy-stick (ENTER, ▲, ▶, ▼, ◀)
25. Setup button (SET UP)
26. On-screen display button (DISPLAY)

Inserting batteries

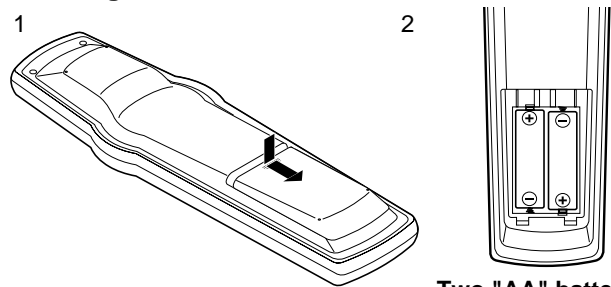

Two "AA" batteries (supplied)

NOTE:

Remove the batteries if the remote control is not to be used for a month or more. Batteries left in the unit may leak and cause damage.

IMPORTANT NOTE:

SPENT OR DISCHARGED BATTERIES MUST BE RECYCLED OR DISPOSED OF PROPERLY IN COMPLIANCE WITH ALL APPLICABLE LAWS. FOR DETAILED INFORMATION, CONTACT YOUR LOCAL COUNTY SOLID WASTE AUTHORITY.

Remote control range

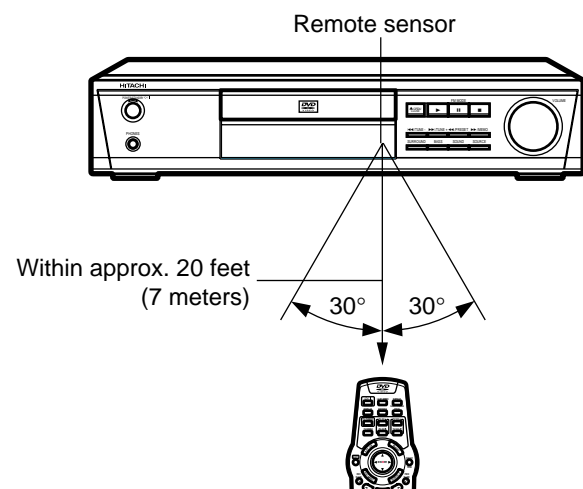

To set the remote control code for the Hitachi TV

This remote control can operate the basic function of TVs. Follow the steps below to enter the remote control code for the Hitachi TV.

- While holding down [TV POWER], enter the 2-digit code [0] and [2], then release [TV POWER].
 - The remote control is now set to operate the Hitachi TV.

IMPORTANT NOTE:

If the batteries in the remote control are changed, the code settings for the TV must be re-entered.

To set the remote control code for the other TVs

This remote control can operate the basic functions of TVs made by the manufacturers listed below.

To enter the remote control code for your brand of TV, follow the steps below.

- In the chart below, find the code corresponding to your brand of TV .
- While holding down [TV POWER], enter the 2-digit code using the number buttons [0 - 9], then release [TV POWER].
 - The remote control is now set to operate your TV.

TV brands	Code
ADMIRAL	05, 10, 13
EMERSON	17
FISHER	03
GE	07
GOLD STAR	01
JVC	15
MAGNAVOX	08
MATSUSHITA	12, 18
MITSUBISHI	14
PANASONIC	12, 18
QUASAR	12, 18
RCA	06
SAMSUNG	16
SANYO	03
SHARP	00, 13
SONY	11
TECHNOL ACE	05
TOSHIBA	04
ZENITH	09, 10

Notes:

- Only remote-controlled TVs can be operated using this remote control. (Refer to your TV instruction manual for more details.)
- There may be some older TV models that cannot be operated with this remote control. If this is the case, use the original remote control supplied with the TV.

IMPORTANT NOTE:

If the batteries in the remote control are changed, the code settings for the TV must be re-entered.

Write your code number below for future reference.

TV: _____

Notes on using the Joy-stick

The Joy-stick has five functions depending on the direction it is moved.

- Press straight down: ENTER
- Tilt towards the front: ▲
- Tilt towards the right: ►
- Tilt towards the back: ▼
- Tilt towards the left: ◀



Note: Control the stick using your thumb.

BASIC CONNECTIONS

Note:

Do not connect the power cord to a 120V AC 60 Hz outlet until all connections have been made.

Speaker Connections

To achieve proper stereo reproduction, connect the speaker wires without shorting to adjacent wires as shown below.

Speaker Wire Color	Use
Black and Red	Front right speaker
Black and Blue	Front left speaker
Black and Green	Center speaker
Black and Orange	Surround right speaker
Black and Gray	Surround left speaker
Black and Brown	Subwoofer

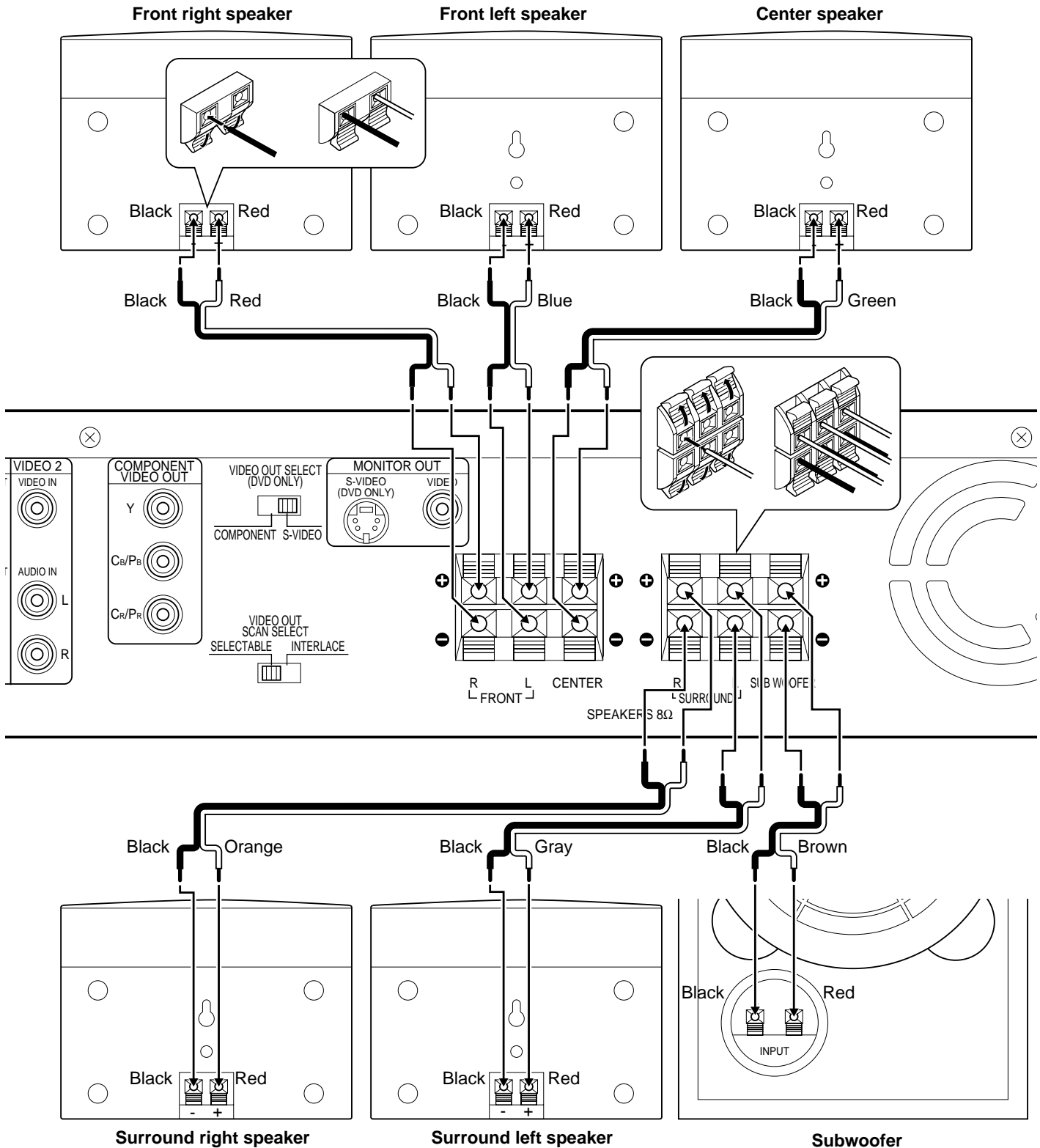

Speaker Placement

The supplied speakers have built-in magnetic stray field compensation. They may be placed close to a TV without affecting the color purity.

The five speakers are all the same and can be used for Front left, Center, Front right, Surround left, and Surround right speakers.

Note:

If you use any other speaker system, please refer to "Speaker" on the INITIAL SETTINGS at the DVD function. (See Page E32.)

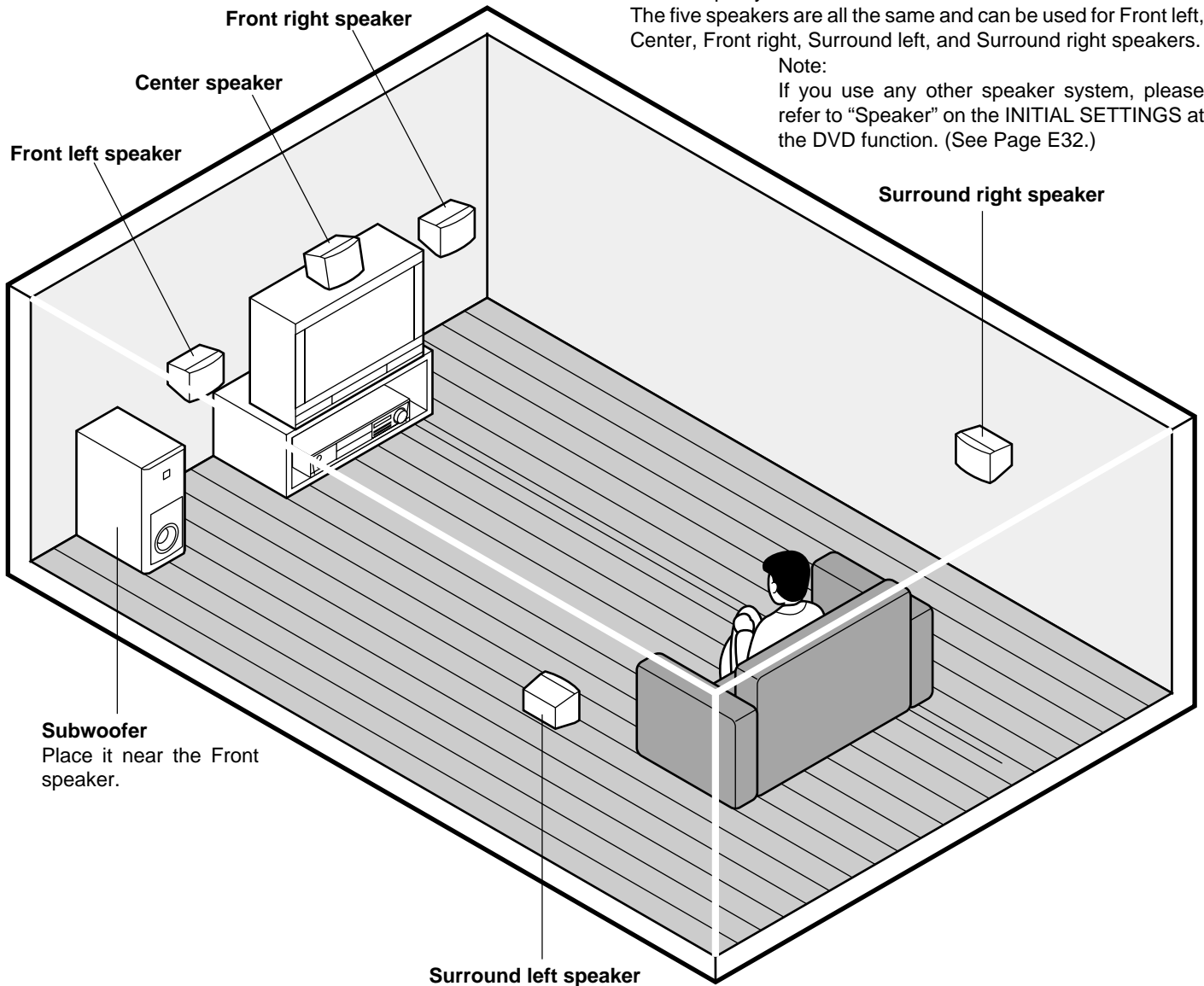

ENGLISH

Subwoofer
Place it near the Front speaker.

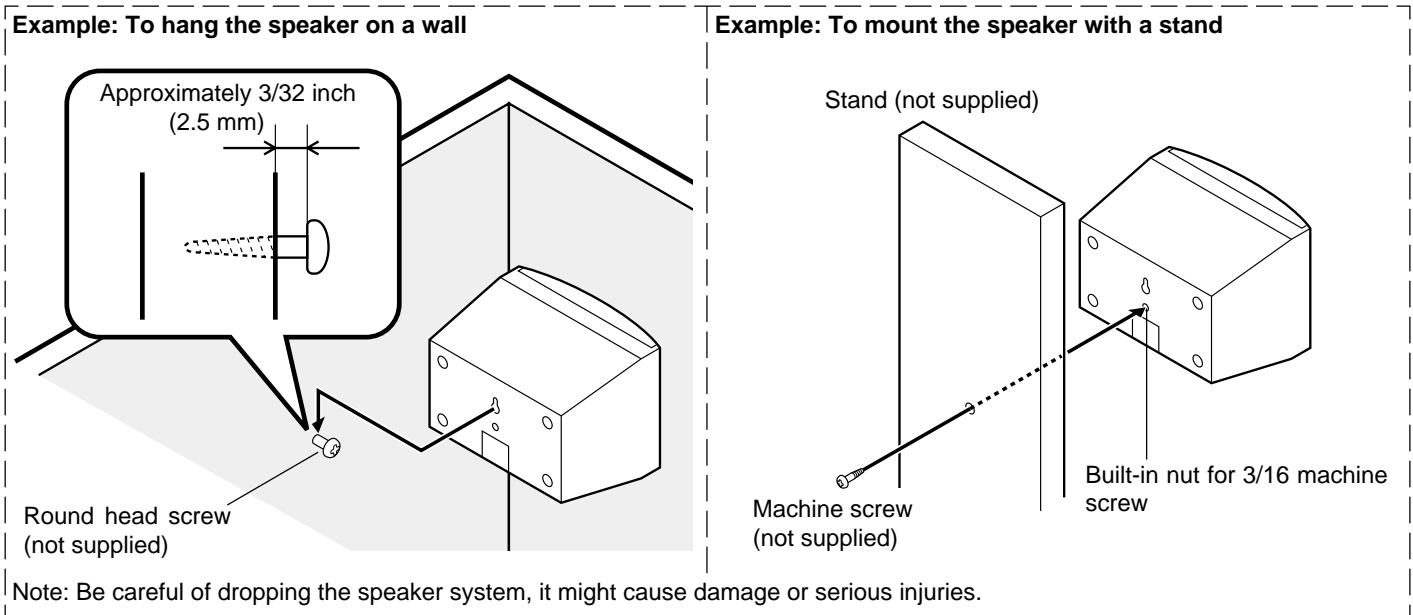

Antenna Connections

CAUTION:

When installing an outdoor antenna, follow the installation instructions in the attached "IMPORTANT SAFETY INSTRUCTIONS".

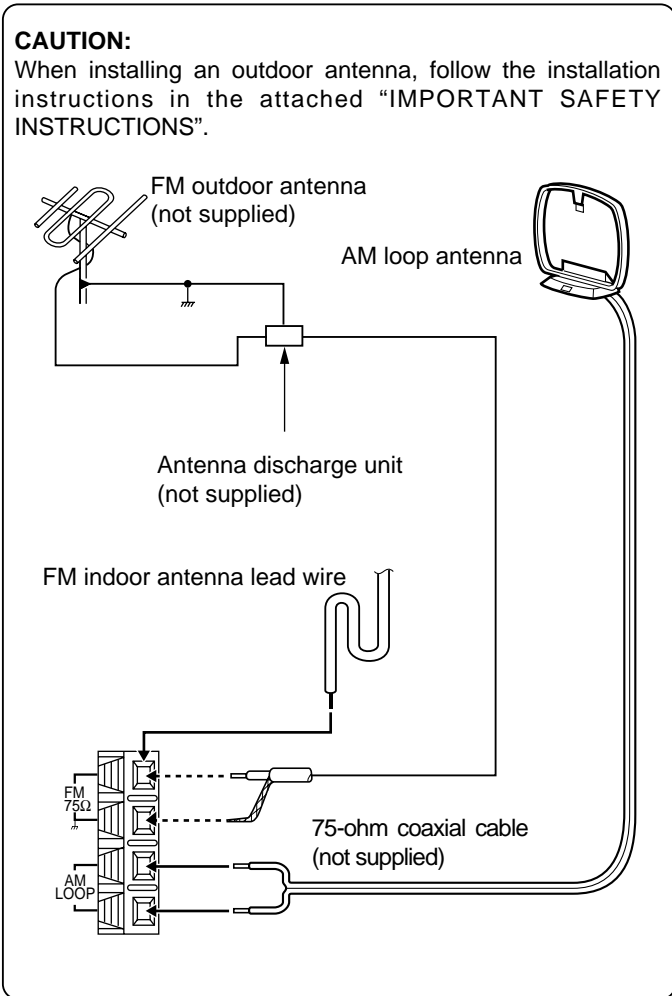

FM antenna

The FM indoor antenna lead wire is sufficient to receive most local FM broadcasts and should be connected to the rear FM 75Ω terminal. Extend the antenna lead wire as straight as possible and, while listening to the sound from the system, secure it in a position where the best FM reception is found.

In fringe areas, or where reception is distorted or noisy, an FM outdoor antenna (not supplied) should be connected instead of the FM indoor antenna lead wire. The terminals will accept 75-ohm coaxial cable.

AM antenna

The AM loop antenna is sufficient to receive most local AM broadcasts. Assemble the loop antenna.

Unwind the antenna wires, then connect them to the AM LOOP terminals. Place the loop antenna in a position which yields the best AM reception, or attach it to a wall or other surface as shown.

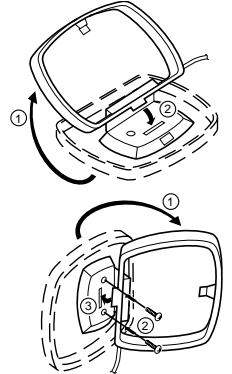

Screws (not supplied)

NOTE:

To minimize noise...

- Keep the speaker wires, power cord and all other system connection cables away from the loop antenna.
- Do not place the antenna close to a TV or speaker.

Note to CATV system installer:

This reminder is provided to call the CATV system installer's attention to Section 820-40 of the NEC which provides guidelines for proper grounding and, in particular, specifies that the cable ground shall be connected to the grounding system of the building, as close to the point of cable entry as practical.

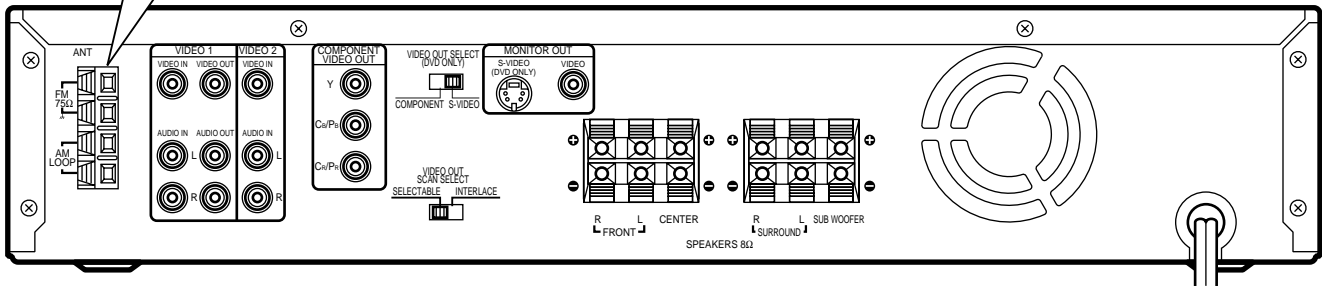

Conventional TV Connections

Using MONITOR OUT VIDEO jack

Connect the Video cable with yellow connectors (supplied) between the MONITOR OUT VIDEO jack of the unit and the VIDEO INPUT jack on the TV.

Important Information:

To connect the unit to a TV, TV must have a Video input jack (RCA-type) at least. You cannot connect it to an antenna terminal of TV.

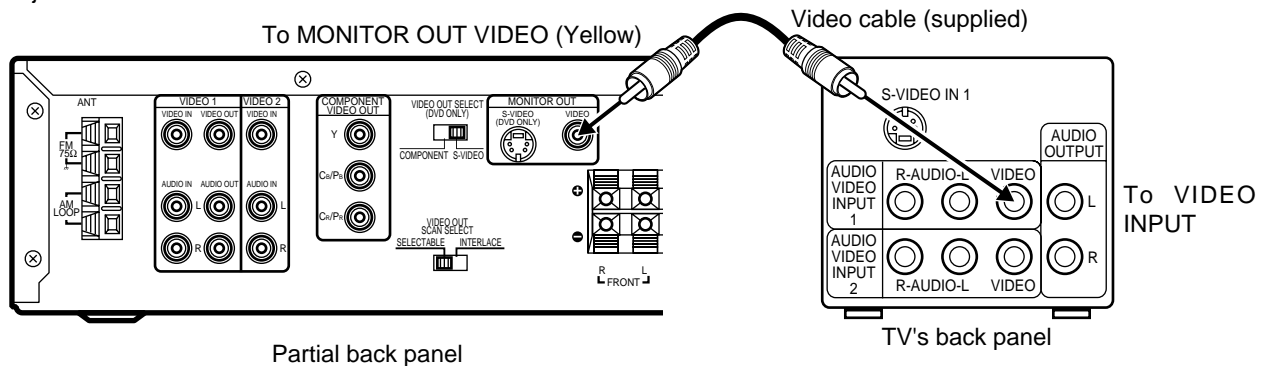

Notes:

- Please refer to the instruction manual of your TV.
- When you connect the unit to your TV, be sure to turn off the power and disconnect both units from the wall outlet until all the connections have been made.
- Do not connect the MONITOR OUT (S-VIDEO/VIDEO) and COMPONENT VIDEO OUT jacks of the unit to a VCR directly. The playback picture will be distorted because DVD video discs are copy protected.

Using MONITOR OUT S-VIDEO jack

Note:

Please follow the steps before turn on the power.

1. If your TV has the S-VIDEO INPUT jack, connect the *Super-Video cable (not supplied) between the MONITOR OUT S-VIDEO jack of the unit and the S-VIDEO INPUT jack of the TV. (The MONITOR VIDEO OUT jack connection is not necessary.)
You can enjoy clearer picture playback.
2. Set the VIDEO OUT SELECT switch to the **S-VIDEO** position.

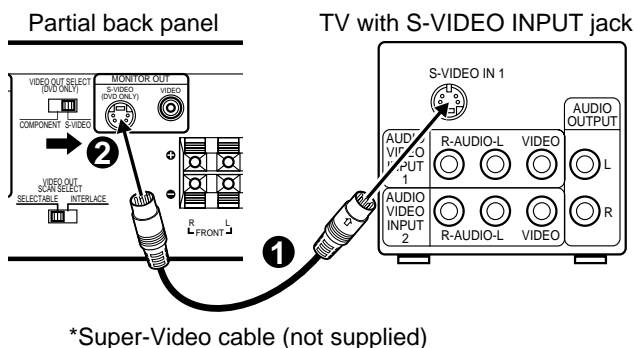

*Super-Video cable (not supplied)

*Please consult your local audio/video dealer.

Using COMPONENT VIDEO OUT jacks

Note:

Please follow the steps before turn on the power.

1. If your TV has the COMPONENT VIDEO INPUT jacks, connect the *Component Video cable (not supplied) between the COMPONENT VIDEO OUT jacks of the unit and the COMPONENT VIDEO INPUT jacks of the TV. (The MONITOR VIDEO OUT or S-VIDEO OUT jack connection is not necessary.)
You can enjoy high quality picture playback.
2. Set the VIDEO OUT SELECT switch to the **COMPONENT** position.
3. Set the VIDEO OUT SCAN SELECT switch to the **INTERLACE** position.

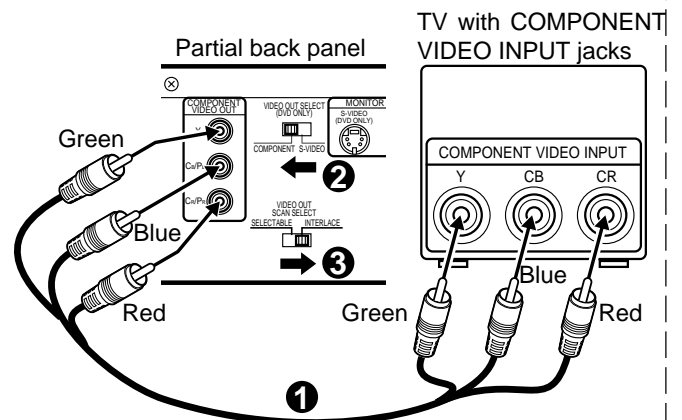

*Component Video cable (not supplied)

*Please consult your local audio/video dealer.

Note:

When watching VCR, you must connect the Video cable between the MONITOR OUT VIDEO jack of the unit and the VIDEO INPUT jack of the TV. There are no VCR video signals from S-VIDEO OUT and COMPONENT VIDEO OUT jacks of the unit.

Using RF Modulator

If your TV does not have a Video input jack and has an antenna terminal only, please purchase the *RF Modulator (not supplied). (*Please consult your audio/video dealer.)

Example: Unit, TV and RF Modulator connections

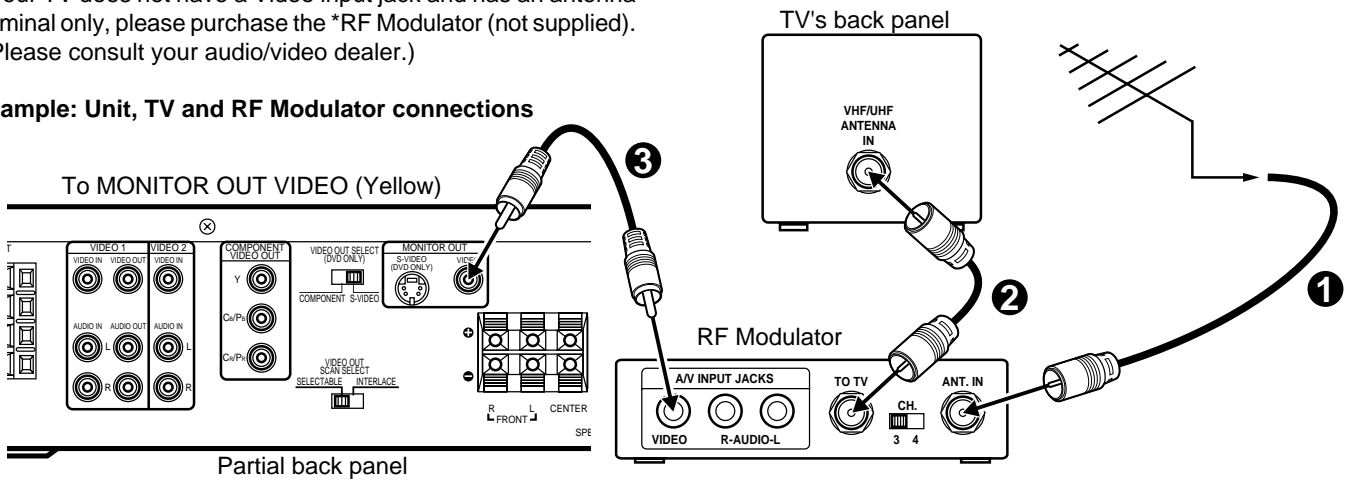

1. Connect the antenna cable (not supplied) to the ANT. IN terminal of the RF Modulator.
 2. Connect the 75-ohm coaxial cable (not supplied) between the TO TV terminal of the RF Modulator and the VHF/UHF ANTENNA IN terminal of the TV.
 3. Connect the Video cable with yellow connectors (supplied) between the MONITOR OUT VIDEO jack of the unit and the VIDEO input jack of the RF Modulator.
- Note:
For more details, please refer to the instruction manual of the RF Modulator.

Example: Unit, VCR, TV and RF Modulator connections

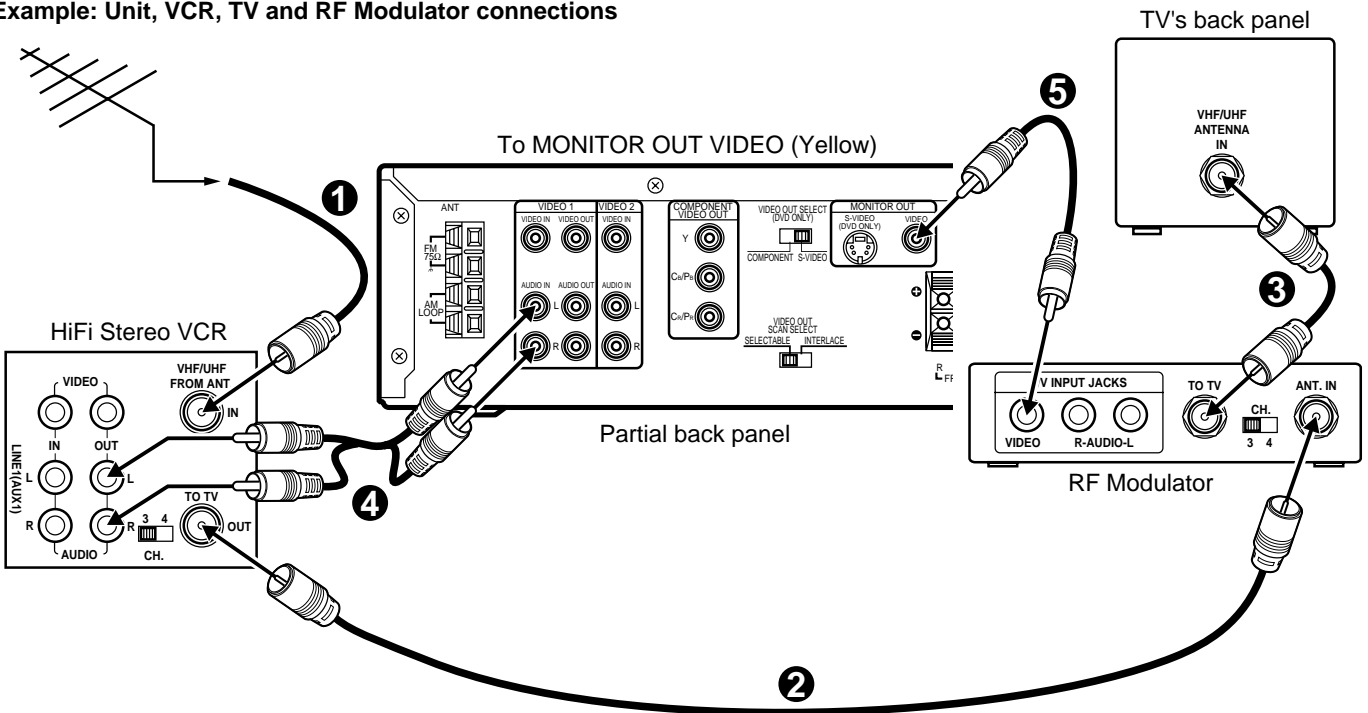

1. Connect the antenna cable (not supplied) to the VHF/UHF FROM ANT IN terminal of the VCR.
 2. Connect the 75-ohm coaxial cable (not supplied) between the TO TV OUT terminal of the VCR and the ANT. IN terminal of the RF Modulator.
 3. Connect the 75-ohm coaxial cable (not supplied) between the TO TV terminal of the RF Modulator and the VHF/UHF ANTENNA IN terminal of the TV.
 4. Connect the audio cables (not supplied) between the VIDEO 1 AUDIO IN jacks of the unit and the AUDIO OUT jacks of the VCR. Use the red connectors for the right-R jacks and the white connectors for the left-L jacks.
 5. Connect the Video cable with yellow connectors (supplied) between the MONITOR OUT VIDEO jack of the unit and the VIDEO input jack of the RF Modulator.
- Note:
For more details, please refer to the instruction manual of the RF Modulator.

Progressive-scan TV Connections

Your TV must be capable of handling progressive scanning and have component video input capability.

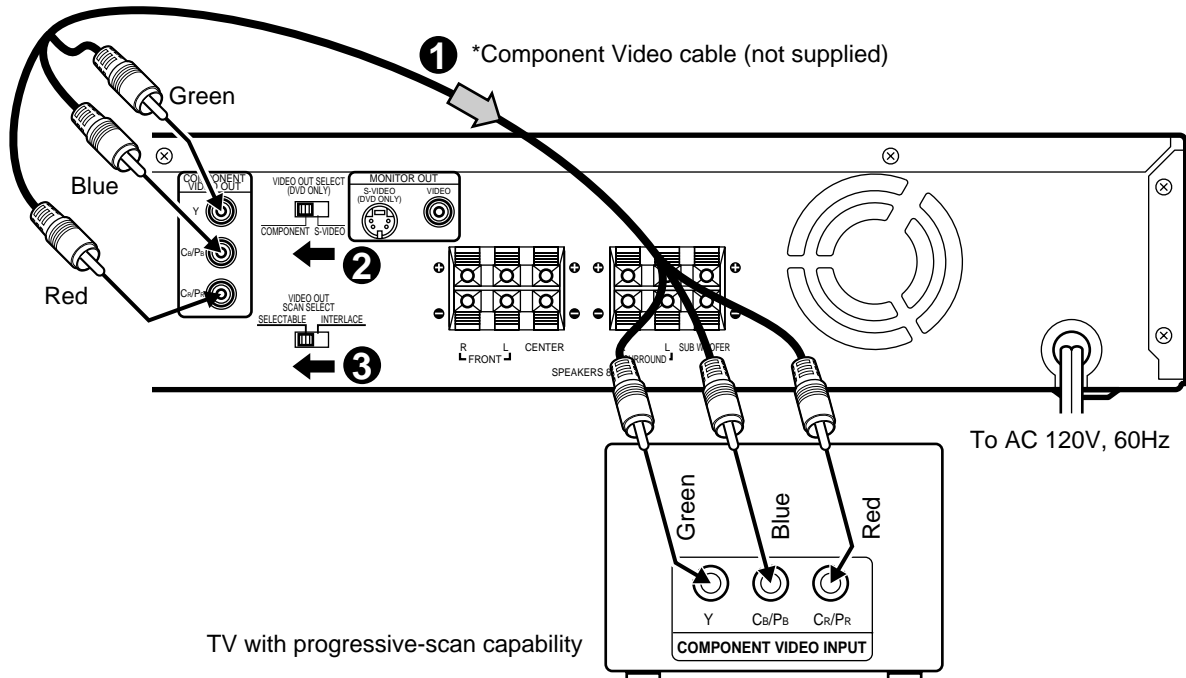

*Please consult your local audio/video dealer.

Please follow the steps before turn on the power.

1. Connect the *Component Video cable (not supplied) between the COMPONENT VIDEO OUT jacks of the unit and the COMPONENT VIDEO INPUT jacks of the TV.
2. Set the VIDEO OUT SELECT switch to the **COMPONENT** position.
3. Set the VIDEO OUT SCAN SELECT switch to the **SELECTABLE** position.
4. Select "COMPONENT OUTPUT: PROGRESSIVE" in "Display" on the INITIAL SETTINGS. (See Page E31.)

Notes:

- Please refer to the instruction manual of your TV.
- When you connect the unit to your TV, be sure to turn off the power and disconnect both units from the wall outlet until all the connections have been made.
- Do not connect the unit to a VCR directly. The playback picture will be distorted because DVD video discs are copy protected.
- As above connections, there are no video signals from the MONITOR OUT VIDEO and VIDEO 1 VIDEO OUT jacks.

Progressive Scanning

While interlaced scanning produces one frame of video in two fields, progressive scanning creates one frame in one field. Conventional interlaced scanning constitutes one second with 30 frames (60 fields), but progressive scanning constitutes it with 60 frames from scratch. Progressive scanning can reproduce sharper picture with high resolution for still image or other picture containing long texts or horizontal lines. This model has compliance with 525p (progressive) system.

Interlaced scanning

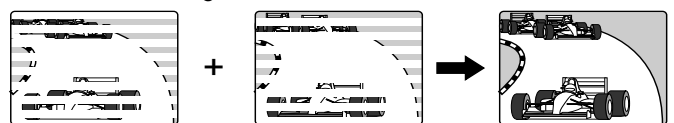

Progressive scanning

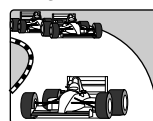

Additional Connection Examples

VCR Connections

With this connection, it is possible watch and listen to videocassettes or other video equipment.

Example:

Using VIDEO 1 jacks

1. Connect the *video cable (not supplied) with yellow connectors between the VIDEO 1 VIDEO IN jack of the unit and the VIDEO OUTPUT jack of the HiFi Stereo VCR (1st).
2. Connect the *audio cables (not supplied) between the VIDEO 1 AUDIO IN jacks of the unit and the AUDIO OUTPUT jacks of the HiFi Stereo VCR (1st). Use the red connectors for the right-R jacks and the white connectors for the left-L jacks.
3. Connect the *video cable (not supplied) with yellow connectors between the VIDEO 1 VIDEO OUT jack of the unit and the VIDEO INPUT jack of the HiFi Stereo VCR (1st).
4. Connect the *audio cables (not supplied) between the VIDEO 1 AUDIO OUT jacks of the unit and the AUDIO INPUT jacks of the HiFi Stereo VCR (1st). Use the red connectors for the right-R jacks and the white connectors for the left-L jacks.

Note:

There are no VIDEO 1 VIDEO/AUDIO IN input signals from the VIDEO 1 VIDEO OUT /AUDIO OUT jacks.

Using VIDEO 2 jacks

(If using HiFi Stereo VCR (2nd) or other video equipment...)

5. Connect the *video cable (not supplied) with yellow connectors between the VIDEO 2 VIDEO IN jack of the unit and the VIDEO OUTPUT jack of the HiFi Stereo VCR (2nd) (or other video equipment).
6. Connect the *audio cables (not supplied) between the VIDEO 2 AUDIO IN jacks of the unit and the AUDIO OUTPUT jacks of the HiFi Stereo VCR (2nd) (or other video equipment). Use the red connectors for the right-R jacks and the white connectors for the left-L jacks.

Notes:

- The picture from VCR may be distorted in some cases.
- MONITOR OUT, S-VIDEO and COMPONENT VIDEO OUT are only active when playing back DVD/VCD.

*Please consult your local audio/video dealer.

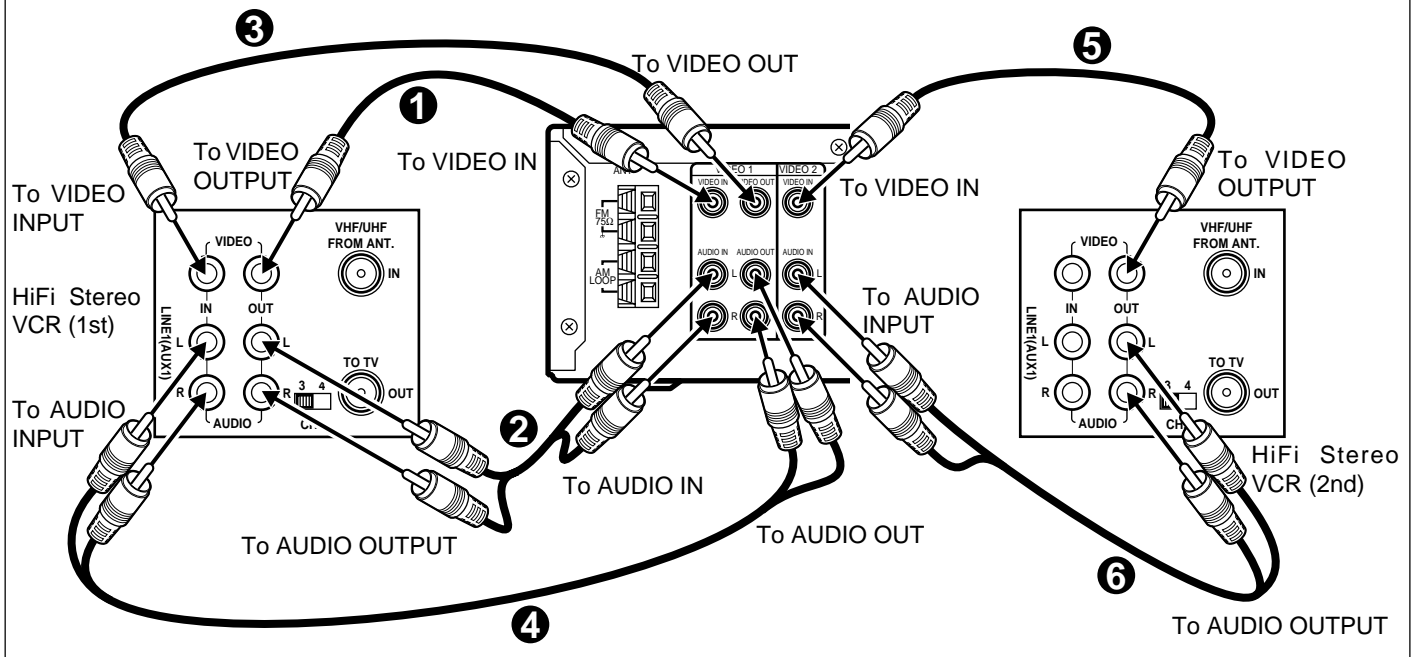

Headphones jack (PHONES)

Connect a pair of stereo headphones (8 ohms - 32 ohms, not available from Hitachi) to the PHONES jack for monitoring or for private listening. The speakers are automatically disconnected when headphones are connected.



Power Supply

Connect the power cord to a 120VAC 60Hz outlet. This unit is equipped with a polarized plug. If you have difficulty inserting the plug, turn it over and reinsert it. If the unit will not be used for a long time, disconnect the AC plug from the AC outlet.

Notes:

- Before plugging the power cord into an AC outlet, make sure that all the connections have been made.
- The unit is not disconnected from the AC power unless the power cord is unplugged from the AC outlet.

ADJUSTING THE CLOCK

Example: To set "PM 6:30" (Using the remote control)

1. Press [POWER]. The STANDBY indicator goes off.
2. Press [CLOCK] while holding [SHIFT] down.
"AM 12:00" blinks.
3. Press [ADJUST] while holding [SHIFT] down.
The "hours" display blinks.

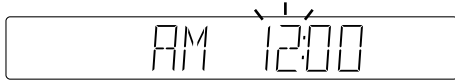

4. Press [NEXT/TUNE+] or [PREV/-TUNE] to set the "hours".

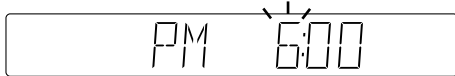

5. Press [ADJUST] while holding [SHIFT] down.
The "minutes" display blinks.

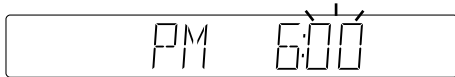

6. Press [NEXT/TUNE+] or [PREV/-TUNE] to set the "minutes".

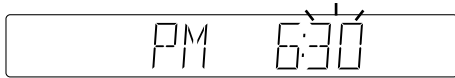

7. Press [ADJUST] while holding [SHIFT] down.
The clock starts.

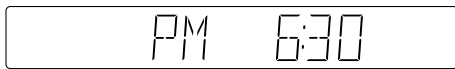

- The time can be set accurately by pressing [ADJUST] while holding [SHIFT] down when a time signal is heard.

To display the clock during operation

Press [CLOCK] while holding [SHIFT] down to display the clock.
(If leave it, the original display returns after approximately 15 seconds.)

Press [CLOCK] again while holding [SHIFT] down to return to the original display.

Note:

If a power failure occurs, reset the clock again.

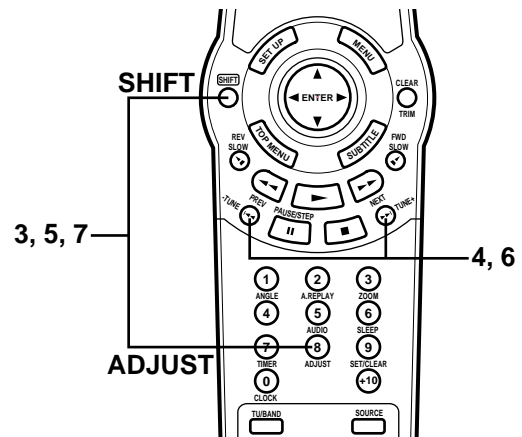
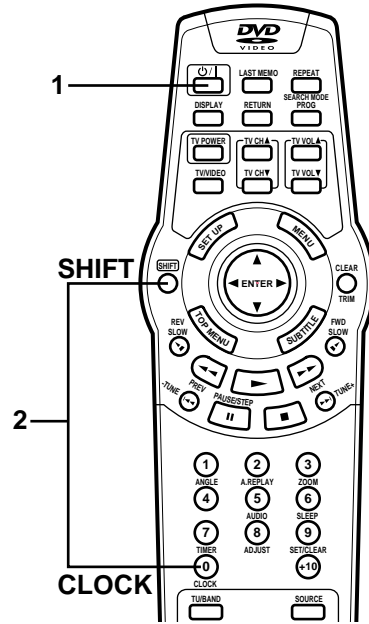

BEFORE OPERATION

Common Operation

POWER/STANDBY \odot /I

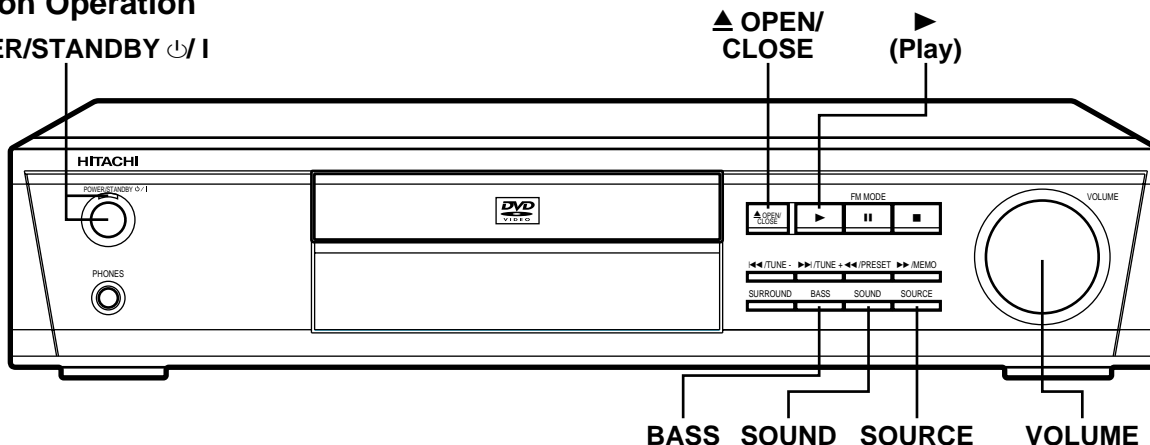

Turning the power on and off

Press [POWER/STANDBY] (or [\odot /I] on the remote control). The STANDBY indicator goes out. (After connecting the power cord, when you press [POWER/STANDBY] (or [\odot /I] on the remote control) for the first time, the volume-reset feature automatically sets the initial volume level.)

To turn the power off, press [POWER/STANDBY] (or [\odot /I] on the remote control) again. The STANDBY indicator lights.

- When the power cord is connected to the AC outlet, the unit will respond to commands from the remote control.

Smart start function

If the following buttons are pressed when the power is turned off, the unit turns on automatically and the selected source is activated.

- [\blacktriangle OPEN/CLOSE], [\blacktriangleright] (Front panel of the unit)
- [\blacktriangleright], [TU/BAND] (Remote control)

Selecting the source

Press [SOURCE] to select the desired source. Each time the button is pressed, the display changes as follows:

- DVD
- VIDEO 1
- VIDEO 2
- FM
- AM

- When the source selection is changed, disc playback automatically stops.

Adjusting the volume

Rotate [VOLUME] (or press [VOLUME] \blacktriangle or \blacktriangledown on the remote control). The volume level appears on the display (VOL 0 ~ VOL MAX).

To reduce the volume temporarily (muting)

Press [MUTE] on the remote control.
(The volume control illumination blinks.)
To restore the previous volume setting, press [MUTE] again.

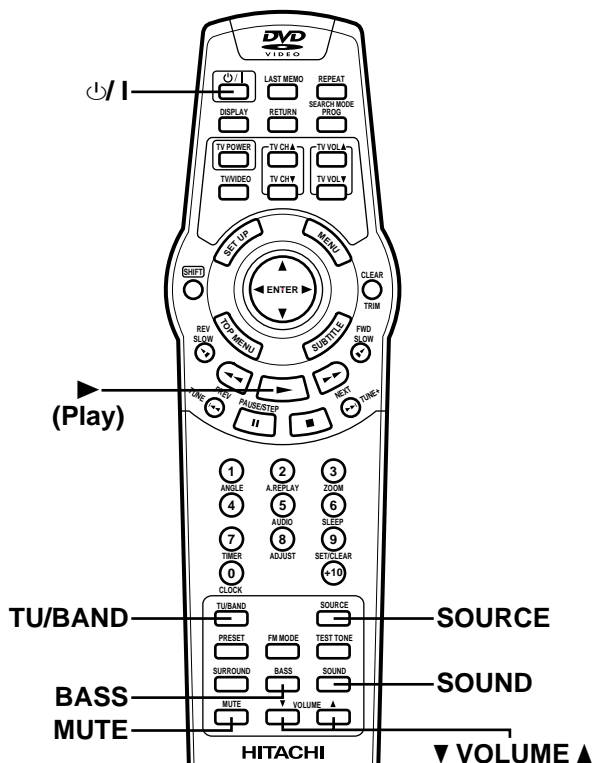

Selecting the sound mode

Press [SOUND] to select the sound mode matching the source to be listened to.

- POP: Pops, etc.
- CLASSIC: Classical music, etc.
- ROCK: Rock music, etc.
- JAZZ: Jazz, etc.

Bass boost system

Press [BASS] to select the desired bass boost effect.
BASS OFF \rightarrow BASS ON1 \rightarrow BASS ON2 \rightarrow BASS OFF ...

Selecting the Surround Mode

Press [SURROUND] to select the surround mode.
 Each time [SURROUND] is pressed, the surround mode (and display) changes as follows.
 DOLBY PL → DOLBY 3 → THEATER → HALL → SURR OFF → DOLBY PL...

Note:
 Some discs may restrict the selection.

DOLBY PL:

Dolby Pro Logic mode
 When playing a program source encoded with Dolby Surround Sound (video tape, laser disc, DVD, etc.)

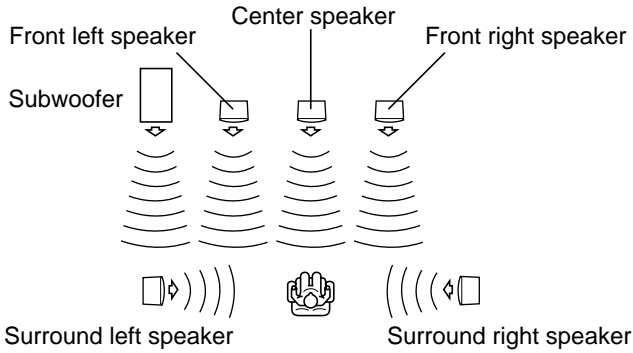

DOLBY 3:

Dolby 3 Stereo mode
 Using only the Front left, Center, Front right and Subwoofer speakers

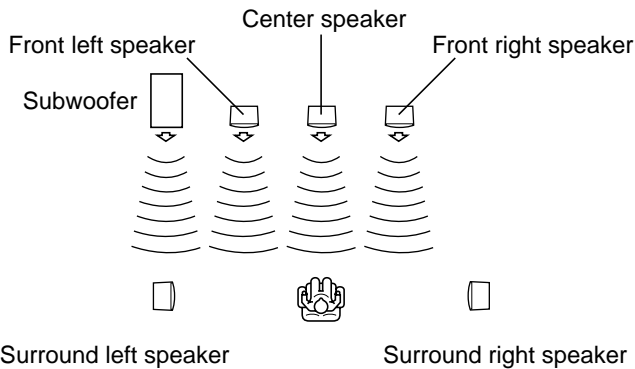

THEATER:

"Theater" effect
 When playing a program source which is not encoded with Dolby Surround sound

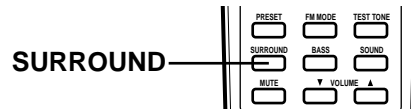
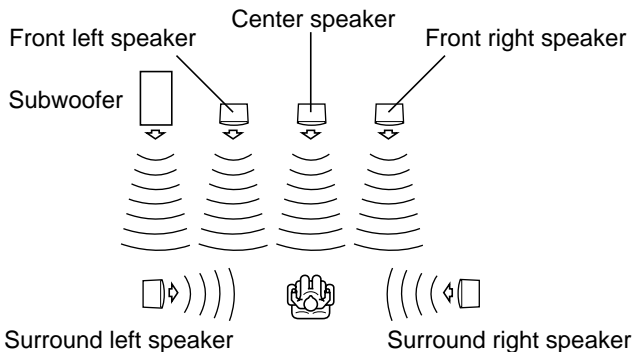

DOLBY D:

Dolby Digital 5.1 Channel mode
When DVD disc encoded with Dolby Digital 5.1 Channel is played back, you can select "DOLBY D".

DTS:

DTS Digital Surround mode
When DVD disc encoded with DTS Digital Surround System (5.1ch) is played back, you can select only "DTS".

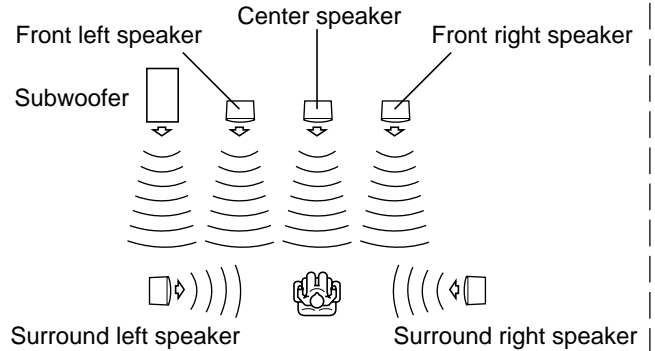

Note:
 Center or Surround speakers do not sound with some discs.

HALL:

"Hall" effect
 When playing a program source which is not encoded with Dolby Surround sound

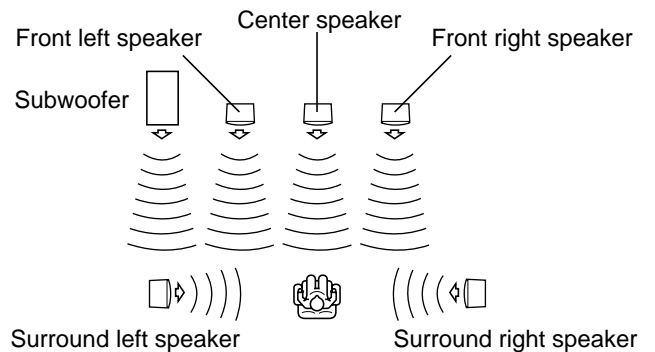

SURR OFF:

Normal stereo sound
 Using only the Front left, Front right and Subwoofer speakers

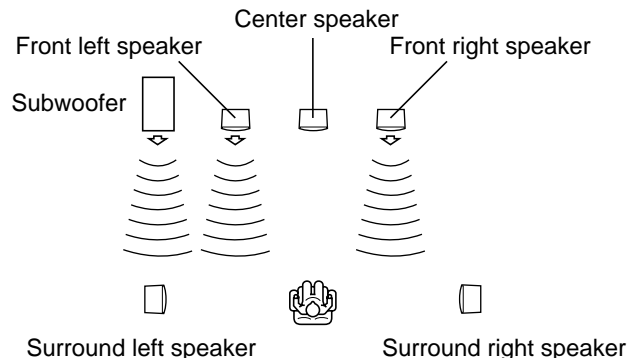

Adjusting the Speaker Volume Level

This unit is set to the standard level before shipping from the factory. You may not need adjustment.

But, depending on the size of the room and the placement of the speakers, you may need a fine adjustment.

In this case, follow the steps below. Please use the remote control at the listening point.

1. Press [SOURCE] to select the desired function.
2. Press [SURROUND] repeatedly to select the desired surround mode ("DOLBY PL", "DOLBY 3", "THEATER" or "HALL").
(See "Selecting the Surround Mode" on Page E16.)
3. Press [TEST TONE] on the remote control.
"TTONE" appears and "FL" blinks.
The test tone will be heard from each speaker sequentially as follows.

Surround mode	FL display (Speaker)
DOLBY PL THEATHER HALL	FL (Front left speaker) C (Center speaker) FR (Front right speaker) RS (Surround right speaker) LS (Surround left speaker)
DOLBY 3	FL (Front left speaker) C (Center speaker) FR (Front right speaker)

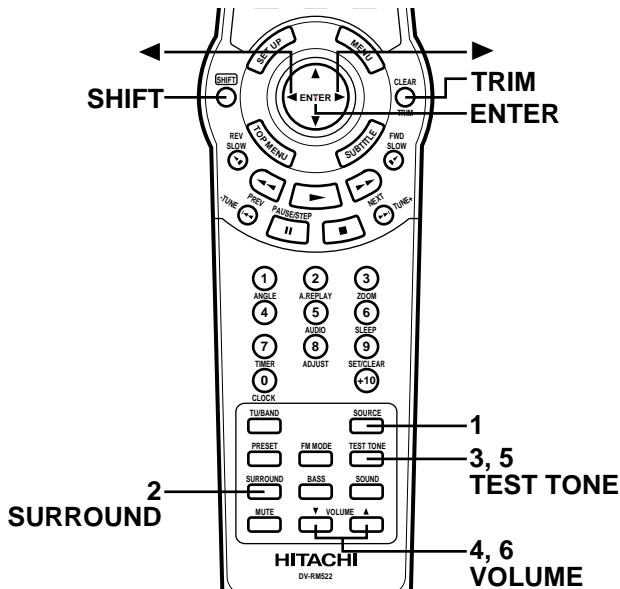

4. Press [VOLUME] ▲ or ▼ until the test tone is at a comfortable level.

If the test tone level is not the same from each speaker, you may need fine adjustment of the volume level. Please follow the steps as below.

Note:

If no adjustments are made, the original display returns after approximately 15 seconds.

- 1) Press [TEST TONE] to turn the test tone off.
- 2) Press [SURROUND] to select the desired surround mode.
- 3) Press [TRIM] while holding [SHIFT] down.
"FNLT 0" appears.
- 4) Press [ENTER] repeatedly to select the speaker.

FL display (Speaker)

FNLT (Front left speaker)
CENT (Center speaker)
FNTR (Front right speaker)
SURR (Surround right speaker)
SURL (Surround left speaker)
SUBW (Subwoofer)

- 5) Press [▶] or [◀] to adjust the volume level.
FNLT/FNTR: "0" ~ "-10" appears.
CENT/SURR/SURL/SUBW: "+10" ~ "-10" appears.
- 6) Press [ENTER].
- 7) Repeat step 4) to 6) for another speaker, if necessary.
- 8) Press [TRIM] again while holding [SHIFT] down to turn it off.





5. Press [TEST TONE] to turn the test tone off.
"TTONE" disappears.
6. Press [VOLUME] ▲ or ▼ to adjust the volume as desired.

Notes:

- There is no Dolby Surround effect when monaural program material is used.
- When receiving weak FM broadcasts, switch the Dolby Pro Logic off. The sound quality may improve.
- When headphones are connected while any of the surround modes are selected, the surround mode is switched off automatically. The SURROUND button does not function while headphones are connected.
- Trimming can be set at each function respectively.

PLAYABLE DISCS

The following types of discs can be played on this unit.

Disc type and logo mark		Recorded content	Disc size	Maximum playing time
DVD Video		Audio + Video	5 inches (12 cm)	Approx. 4 hours (Single sided disc) Approx. 8 hours (Double sided disc)
			3 inches (8 cm)	Approx. 80 minutes (Single sided disc) Approx. 160 minutes (Double sided disc)
Video CD	 	Audio + Video	5 inches (12 cm)	74 minutes
			3 inches (8 cm)	20 minutes
Music CD		Audio	5 inches (12 cm)	74 minutes
			3 inches (8 cm)	20 minutes

Region Number

Region number (Regional restriction code) is built-in to the unit and DVD video discs.

Region number "1" or "ALL" of DVD video discs can be used on this unit.



DVD Video Disc

There are the marks on some DVD video disc package.

Examples:



Multiple languages



Multi-language subtitles



Multi-angle

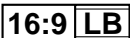

Multi-aspect



Region number

CAUTION:

- Only the above types of discs can be played on this unit. DVD-ROM, CD-ROM, SVCD, CVD, etc. cannot be played.
- This unit can play back the CD-R/RW that have recorded music data or MP3 files as well. However, some CD-R/RWs can not be played back depending on the recording conditions.
- The CD-R/RW that has no music data or non-MP3 files can not be played back.
- This unit is to be used exclusively with the NTSC color system. PAL and SECAM system discs cannot be used with this unit.

DVD Video Disc

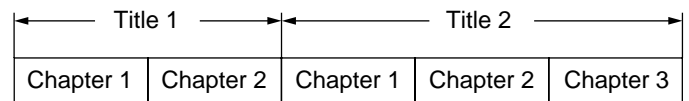

DVD video discs are divided into titles, and the titles are sub-divided into chapters.

Video CD/Music CD Disc

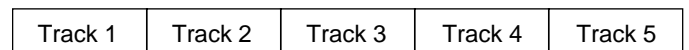

Video CD and Music CD discs are divided into tracks.

Handling, Storing and Cleaning Discs

- Fingerprints and dust should be carefully wiped from the signal surface of the disc (glossy side) with a soft cloth. Wipe in a straight motion from the center to the outside of the disc.
- Never use chemicals such as record cleaning sprays, antistatic sprays or fluids, benzene or thinner to clean the discs. These chemicals will permanently damage the plastic surface of the disc.
- To remove a disc from its storage case, press down on the center of the case and lift the disc out, holding it carefully by the edges.
- Discs should be returned to their cases after use to protect them from dust and scratches.
- To prevent warping the disc, do not expose it to direct sunlight, high humidity or high temperatures for extended periods of time.
- Do not apply paper or write anything on either side of the disc. Sharp writing instruments, or the inks used in some felt-tip pens, may damage the surfaces of the disc.

DISC PLAYBACK

Preparations

- Turn on the TV and select the video input source.

To use the remote control for TV

Note:

You must set the remote control code for TV first. (See Page E6.)

1. Press [TV POWER] to turn on the power.
 - When using the remote control, the Transmitter Window on the remote control must be pointed toward your TV.
2. Press [TV/VIDEO] to select the video input source.
3. Press [TV VOL ▼] to set the TV volume minimum.

Notes:

- Only remote-controlled TVs can be operated using this remote control. (Refer to your TV instruction manual for more details.)
- There may be some older TV models that cannot be operated with this remote control. If this is the case, use the original remote control supplied with the TV.

- Select the playback picture size according to the aspect ratio of the TV. (See "Display" in "INITIAL SETTINGS" on Page E31.)

Basic Playback

Notes:

- Do not touch the disc tray while it is moving.
- Never place anything except a disc on the disc tray. Foreign objects can damage the unit.
- Do not apply excessive force to the disc tray.
- Discs must be placed on the disc tray one at a time.

When operation buttons are pressed, that operation is displayed on the TV screen. The display disappears after several seconds.

1. Press [▲OPEN/CLOSE] on the unit.
 - "OPEN" appears and the disc tray opens.
 - "HITACHI" logo appears on the TV screen.

Note:
To open close the disc tray, be sure to use [▲OPEN/CLOSE]. Do not press the disc tray with your hand.

2. Place the disc with the label facing up on the disc tray.

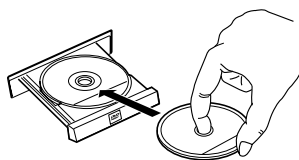

For 5-inch (12cm) disc

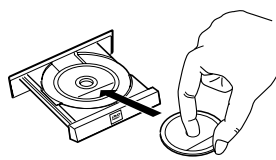

For 3-inch (8cm) disc

Important Note:

- This instruction manual explains the basic instruction of this unit using the remote control unit.
- Some DVD video or Video CD discs have different functions that may not be explained in this instruction manual. You may need extra instructions. In this case, please follow the instructions displayed on the TV screen or jacket or case of the disc.
- "⊘" may appear on the TV screen during operation. This icon means that the function is not available on the disc now.

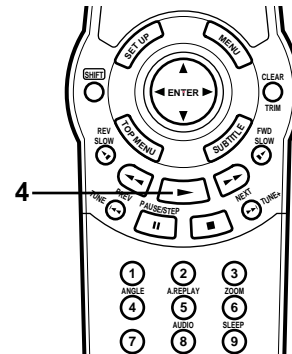
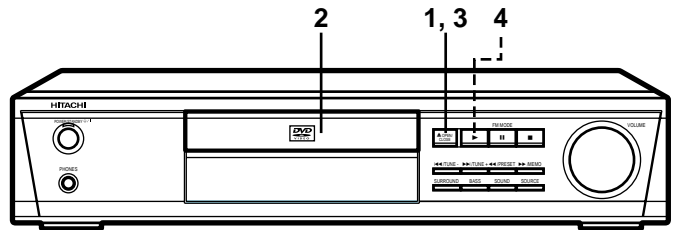

3. Press [▲OPEN/CLOSE] again. The disc tray closes. "READING" appears on the display. Notes:

- Some discs may start playback automatically.
- If the disc is loaded with the label side downward (and it is a single sided disc), or if a badly scratched disc is loaded, "NO DISC" (or "NO PLAY") appears. If this occurs, load the disc correctly or replace the disc.

4. Press [▶] to start playback. Example:

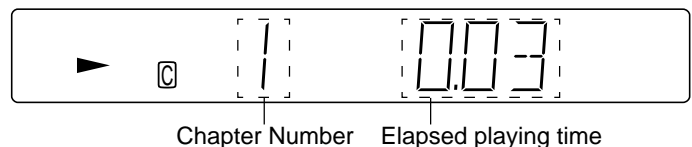

If a menu screen appears on the TV screen...

Select the desired menu by pressing [▲], [▶], [▼] or [◀] (or the number buttons), then press [ENTER]. Playback of the selected menu starts.

Note:

For more details, please refer to the jacket or case of the disc.



Stopping Playback

- Press [■] once during playback. "Resume ■" briefly appears on the TV screen.
When you press [▶], playback starts automatically from the point where you stopped. "▶" briefly appears on the TV screen.
- Note:
Some discs may not resume playback.
- Press [■] twice during playback. "■" briefly appears on the TV screen and playback stops completely.
When you press [▶], playback starts from the beginning of the disc.

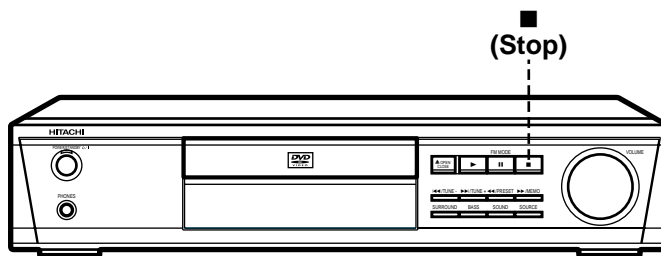

Continuing Playback from Where You Stopped Watching (LAST MEMO PLAY), for DVD only

- Press [LAST MEMO] to stop playback.
"Last Memo ■" briefly appears on the TV screen.
"L.M.-STOP" appears on the display.
- Remove the disc or turn off the power.
- Load the disc (and press [▶]), or turn on the power.
"Last Memory Play?" appears on the TV screen.
Yes
No
Clear ... (The memory is released.)
- Use [▲] to select "Yes".
- Press [ENTER].
Playback resumes from the point where you stopped.
If desired, press [LAST MEMO] again.

Notes:

- Point on up to 5 discs can be memorized.
- The Last Memo Play mode may not work correctly with some discs.

Note:

This unit doesn't have Screen Saver function.
Displaying a still picture (non-movement) on the screen for dozens of minutes cause afterimage (ghost) on the screen.

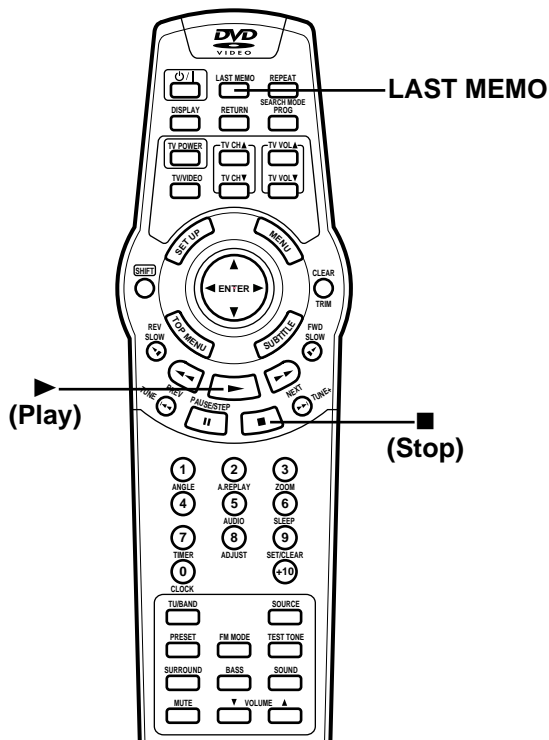

What is "PBC"?

"PBC" is an abbreviation for "Playback Control" that refers to control codes prerecorded on Video CDs.
During playback of Video CD with PBC, "PBC" appears on the display.

This product incorporates copyright protection technology that is protected by method claims of certain U.S. patents and other intellectual property rights owned by Macrovision Corporation and other rights owners. Use of this copyright protection technology must be authorized by Macrovision Corporation, and is intended for home and other limited viewing uses only unless otherwise authorized by Macrovision Corporation. Reverse engineering or disassembly is prohibited.

Selecting a DVD Menu

Notes:

- The operation may differ depending on the disc used.
- Selecting a menu may not be possible on some discs.

1. Press [MENU].
The main menu screen will appear.

Note:

Press [MENU] again to resume playback.

2. Press [▲], [▼], [◀] or [▶] (or the number buttons) to select the desired menu.
3. Press [ENTER]
The selected menu playback starts.

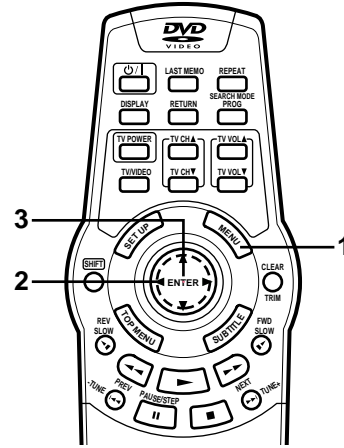

Selecting a Top Menu (Title Menu) [DVD]

Notes:

- The operation may differ depending on the disc used.
- Selecting a menu may not be possible on some discs.

1. Press [TOP MENU].
The top menu (title menu) will appear.

Note:

Press [TOP MENU] again to resume playback from the scene when [TOP MENU] was first pressed.

2. Press [▲], [▼], [◀] or [▶] (or the number buttons) to select the desired menu.
3. Press [ENTER].
The selected menu playback starts.

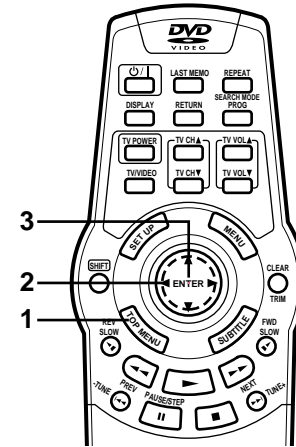

Return button (RETURN) for Video CD

Normally, it returns to the previous menu when [RETURN] is pressed during playback.

Note:

The operation differs according to the content of the Video CD.

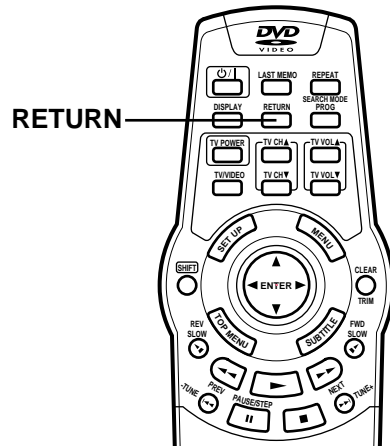

Important Note:

“⊘” may appear on the TV screen during operation. This icon means that the function is not available on the disc now.

Chapter (Track) Skip

Skipping forward

Press [NEXT/TUNE+] (or [▶▶]/TUNE+) during playback to skip to the next chapter (or track).

“▶▶” appears on the TV screen.

A chapter (or track) is skipped each time the button is pressed.

Skipping backward

Press [PREV/-TUNE] (or [◀◀]/TUNE-) during playback to skip back to the beginning of the chapter (or track) currently play.

“◀◀” appears on the TV screen.

Press the button again immediately to skip back to the beginning of the previous chapter (or track).

Note:

You can skip only through the chapters, not over the title on the DVD disc.

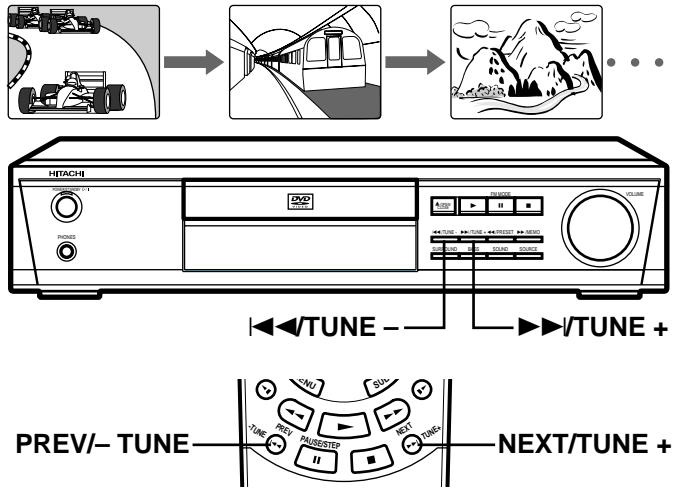

Title Search [DVD]

1. Press [SEARCH MODE] once while holding [SHIFT] down during playback or in the stop mode.

“TITLE SEARCH _ _” appears on the TV screen.

2. Press the number button(s) to enter the title number.

Example:

To select Title No.3, press [3].

To select Title No.10, press [+10], then [0].

To select Title No.24, press [+10], [+10], then [4].

Playback starts from the selected title.

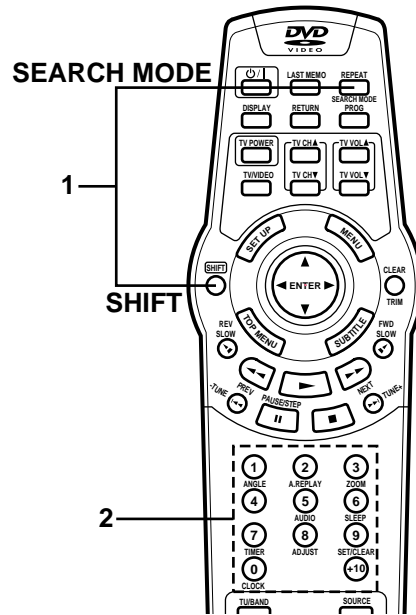

Chapter Search [DVD]

1. Press [SEARCH MODE] twice while holding [SHIFT] down during playback.

“CHAPTER SEARCH _ _” appears on the TV screen.

2. Press the number button(s) to enter the chapter number.

Example:

To select Chapter No.3, press [3].

To select Chapter No.10, press [+10], then [0].

To select Chapter No.24, press [+10], [+10], then [4].

Playback starts from the selected chapter.

Important Note:
“⊘” may appear on the TV screen during operation. This icon means that the function is not available on the disc now.

Time Search [DVD]

1. Press [SEARCH MODE] three times while holding [SHIFT] down during playback.

“TIME SEARCH _ : _ : _” appears on the TV screen.

2. Press the number button(s) to enter the time.

Example:

20 minutes 5 seconds Press [2], [0], [0] and [5].

42 minutes 39 seconds Press [4], [2], [3] and [9].

1 hour 4 minutes 35 seconds Press [1], [0], [4], [3] and [5].

Notes:

- Do not use the [+10] button.
- If you make a mistake, press [CLEAR].

3. Press [▶].

Playback starts from the searched time.

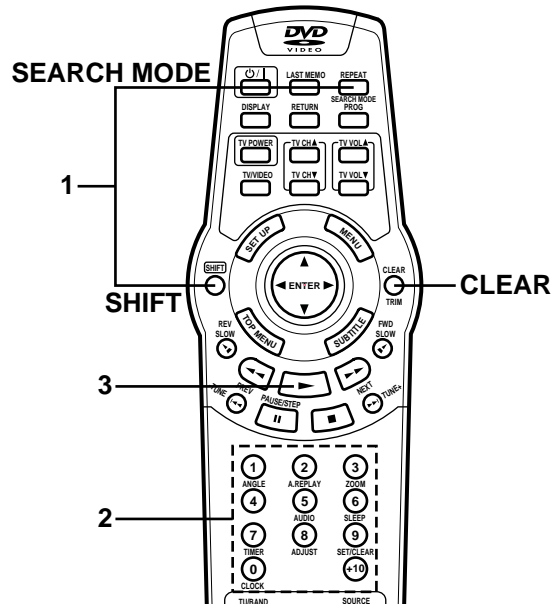

Time Search [Video CD] [CD]

1. Press [SEARCH MODE] once while holding [SHIFT] down during playback.
"TIME SEARCH _ : _ : _" appears on the TV screen.
2. Press the number button(s) to enter the time.
Example:
20 minutes 5 seconds Press [2], [0], [0] and [5].
42 minutes 39 seconds Press [4], [2], [3] and [9].
1 hour 4 minutes 35 seconds Press [1], [0], [4], [3] and [5].
Notes:
 - Do not use the [+10] button.
 - If you make a mistake, press [CLEAR].
3. Press [▶].
Playback starts from the searched time in the track.

Note:

By repeating steps 1 - 3 in the stop mode, playback starts at the searched time in the disc.

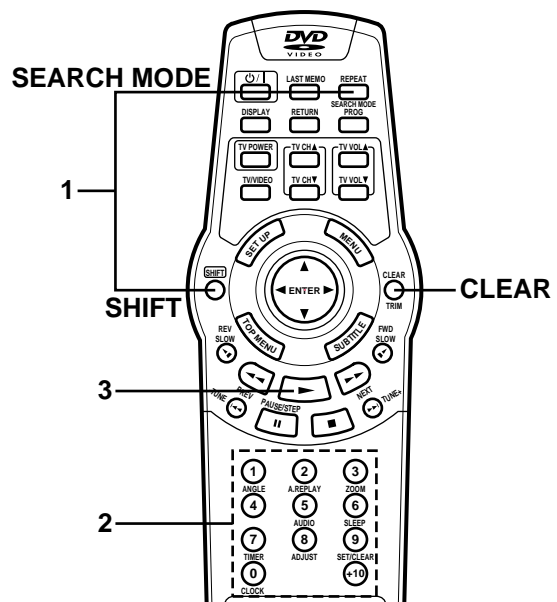

Track Search [Video CD] [CD]

Press the number buttons during playback or in the stop mode.

Example:

To select Track No. 3, press [3].

To select Track No. 10, press [+10], then [0].

To select Track No. 24, press [+10], [+10], then [4].

"TRACK SEARCH" and the selected track number briefly appear.
Playback starts from the selected track.

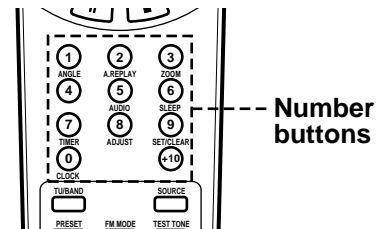

Fast Playback

Fast forward playback

Press [▶▶] repeatedly to select the fast speed forward playback.

[DVD] [Video CD]

"FF1 ▶▶", "FF2 ▶▶" and "FF3 ▶▶" (3 steps)

[CD]

"FF1 ▶▶" and "FF2 ▶▶" (2 steps)

Press [▶] to return to normal playback.

Fast reverse playback

Press [◀◀] repeatedly to select the fast speed reverse playback.

[DVD] [Video CD]

"FR1 ◀◀", "FR2 ◀◀" and "FR3 ◀◀" (3 steps)

[CD]

"FR1 ◀◀" and "FR2 ◀◀" (2 steps)

Press [▶] to return to normal playback.

Note:

The sound is muted during fast playback in DVD and Video CD.

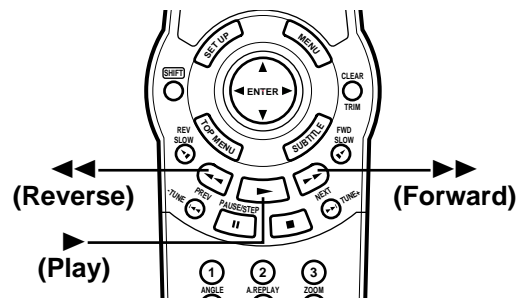

Important Note:

⊘ may appear on the TV screen during operation. This icon means that the function is not available on the disc now.

Slow Motion Playback

Forward slow playback [DVD] [Video CD]

Press [FWD SLOW] repeatedly to select the forward slow speed playback.

“SF1▶”, “SF2▶” and “SF3▶” (3 steps)

Press [▶] to return to normal playback.

Reverse slow playback [DVD]

Press [REV SLOW] repeatedly to select the reverse slow speed playback.

“SR1◀”, “SR2◀” and “SR3◀” (3 steps)

Press [▶] to return to normal playback.

Note:

The sound is muted during slow motion playback.

Important Note:

“⊘” may appear on the TV screen during operation. This icon means that the function is not available on the disc now.

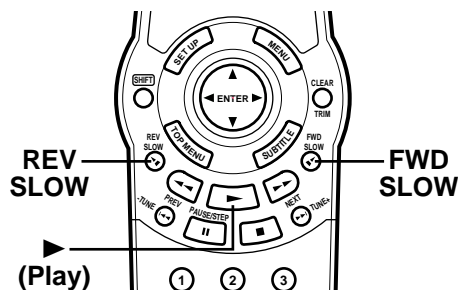

Still Picture (Pause)

Press [PAUSE/STEP] during playback.

- “II” appears on the display.
- “II” briefly appears on the TV screen.

Press [▶] to return to normal playback.

[DVD], [Video CD]

Still picture mode

[CD]

Pause mode

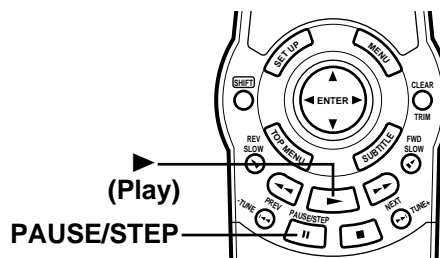

Note: The sound is muted.

Frame by Frame Advance Playback [DVD] [Video CD]

Press [PAUSE/STEP] during still picture.

- “II▶” briefly appears on the TV screen.

Each time the button is pressed, the picture advances one frame.

Press [▶] to return to normal playback.

Notes:

- The sound is muted.
- Frame playback is operated forward only.

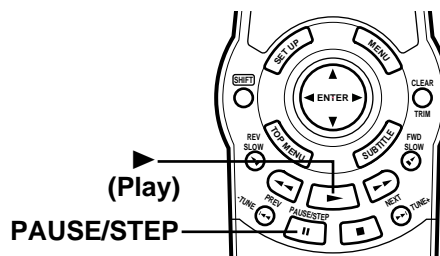

Picture Zoom [DVD] [Video CD]

1. Press [ZOOM] while holding [SHIFT] down during playback. The central part of the picture is magnified, and “Zoom +1” appears on the TV screen.

- Each time you press [ZOOM] while holding [SHIFT] down or press [RETURN], the picture zooms in or out (“Zoom +15” ~ “Zoom -15” appears).
- Each time you press [▲], [▶], [▼] or [◀], the picture moves from side to side, up and down (“PAN Up”, “PAN Right”, “PAN Down”, or “PAN Left” briefly appears).

2. To return playback, press [CLEAR].

Note:

Picture Zoom may not work on some discs.

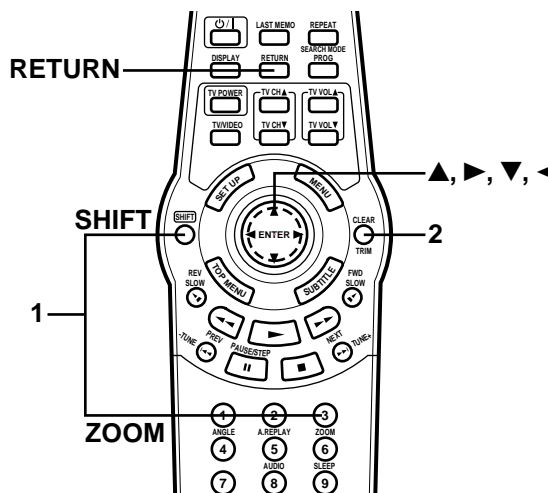

Viewing from a Desired Camera Angle (Multi-Angle) [DVD]

Some DVD video discs may contain scenes which have been shot simultaneously from a number of different camera angles. The jacket or case of discs that are recorded with angles will be marked.

Example:



Note:

The recorded angles differ depending on the disc used.

1. Play the disc that is recorded with angles.
2. Press [ANGLE] repeatedly while holding [SHIFT] down until the desired angle appears.

Example:



Angle Replay

During Multi-angle playback screen, press [A.REPLAY] while holding [SHIFT] down.

The player skips back to last approximately 10 seconds, changes it to the next camera angle and plays it, and continues playback. If desired, press both buttons again.

Repeat Playback

Press [REPEAT] during playback (or programmed playback) of the title (or track) you want to repeat.

Each time the button is pressed, the repeat mode will be changed as follows.

[DVD]

↶ Title (1 REP.): Repeat of title being played

↶ Off: Normal playback mode

[Video CD], [CD]

↶ 1 (1 REP.): Repeat of track being played

↶ All (ALL REP.): Repeat all tracks

↶ Off: Normal playback mode

Note:

Repeat playback may not work correctly with some discs.

Important Note:

“⊘” may appear on the TV screen during operation. This icon means that the function is not available on the disc now.

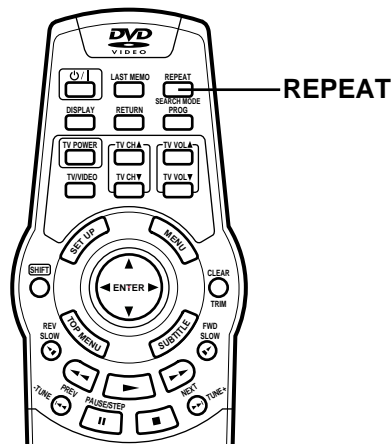
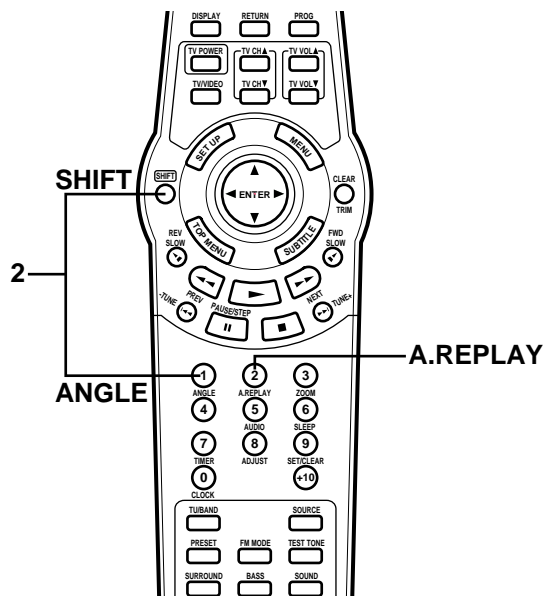
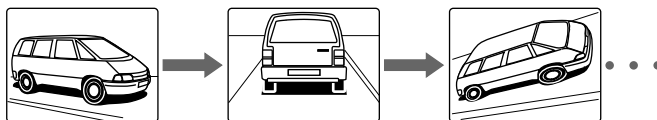

Programmed Playback [Video CD] [CD]

Up to 32 selections can be programmed.

Programming procedure

1. Press [PROG] in the stop mode.
 - “PROGRAM” screen appears.
 - “PROG.” blinks and “Pr. 1” appears on the display.

2. Press the number buttons to select the track number.

Example:

To select Track No.3, press [3].

To select Track No.10, press [1], then [0].

To select Track No.24, press [2], then [4].

Note:

- If you make a mistake, press “CLEAR”.
- Do not use the [+10] button.
- To quit the “PROGRAM” screen, press [PROG].

3. Press [ENTER].

The highlighted box automatically moves next.

Example:

PROGRAM

#	Track	Track Time
1	02	00 : 04 : 57
	--	
	--	
	--	
	--	
	--	
	--	

00 : 04 : 57

Total programmed time

4. Repeat step 2 and 3 above to select another track.
5. Press [▶] to start playback.
 - “PROG.” remains lit.

When all programmed selections have played, the player stops automatically.

 - The program contents are retained in memory.

Note:

To play the program again, press [PROG] to call up the program screen, then press [▶].

Important Note:

“⊘” may appear on the TV screen during operation. This icon means that the function is not available on the disc now.

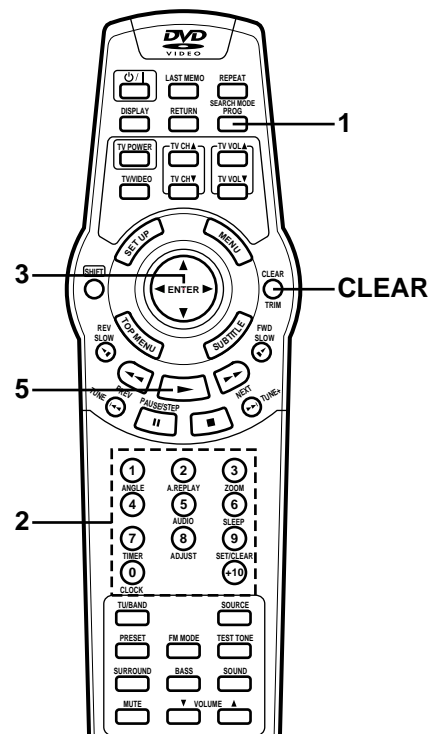

To clear the program one by one

1. Press [PROG] to display “PROGRAM” screen.
2. Press [▲] or [▼] to select the track number.
3. Press [CLEAR].

To clear all the programs

1. Press [PROG] to display “PROGRAM” screen.
2. Press [■].

To change the program

1. Press [PROG] to display “PROGRAM” screen.
2. Press [▲] or [▼] to select the track number.
3. Press the number buttons to select the track number to be replaced.
4. Press [ENTER].

Note:

To quit the “PROGRAM” screen, press [PROG].

Selecting Subtitle Language [DVD]

This operation works only with discs on which multiple subtitle languages are recorded.

1. Press [SUBTITLE] during playback.
"SUBTITLE CHANGE" screen appears.
2. Press [▲] to select "On".
The highlighted box appears.
3. Press [◀] or [▶] to select the desired subtitle language.
Example:

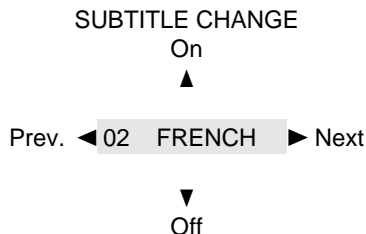

4. Press [SUBTITLE].

Notes:

- In some cases, the subtitle language is not changed to the selected one.
- When a disc supporting closed caption is played, the subtitle and the closed caption may overlap each other on the TV screen. In this case, turn the subtitle off.
- When the desired language is not selected even if the button is pressed, the language is not available on the disc.
- When the power is turned on or the disc is replaced, select the subtitle language again.
- If the subtitle language is not necessary, select "Off".

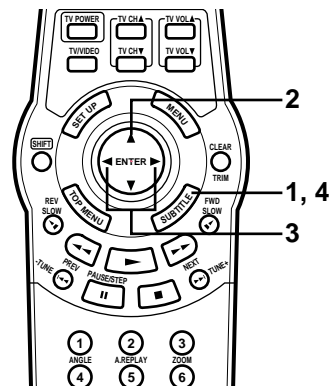

Selecting Audio Soundtrack Language (Multi-Language) [DVD]

This operation works only with discs on which multiple audio soundtrack languages are recorded.

1. Press [AUDIO] while holding [SHIFT] down during playback.
2. Press [AUDIO] repeatedly while holding [SHIFT] down until the desired language appears on the TV screen.

Example:

AUDIO CHANGE 04 FRENCH

Notes:

- When the desired language is not selected even if the button is pressed, the language is not available on the disc.
- When the power is turned on or the disc is replaced, select the language again.
- If the language is not recorded on the disc, only the available language on the disc will be heard.

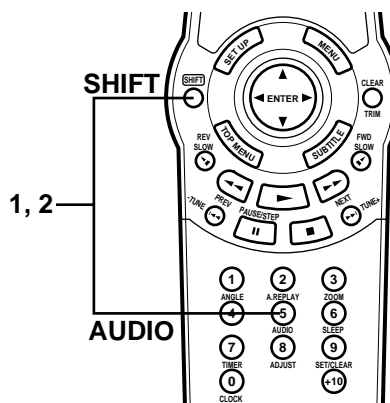
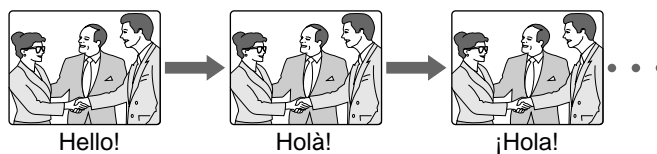

Notes on Video CD playback
Changing the audio channel output
 During Video CD playback, press [AUDIO] while holding [SHIFT] down to select an audio channel (LEFT MONO, RIGHT MONO or STEREO).

Important Note:
 "⊘" may appear on the TV screen during operation. This icon means that the function is not available on the disc now.

Selecting On-Screen Information

Press [DISPLAY] repeatedly to show the disc information (Title, Chapter, Title elapsed playing time, Language, etc.).

Example for DVD:

1. Press [DISPLAY].

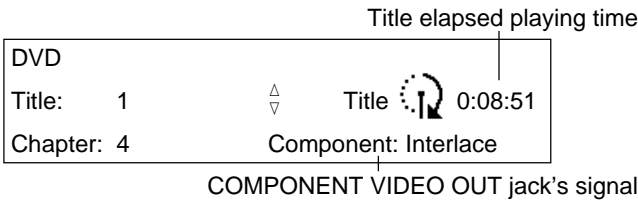

By pressing [▲] or [▼], the Title or Chapter information changes.

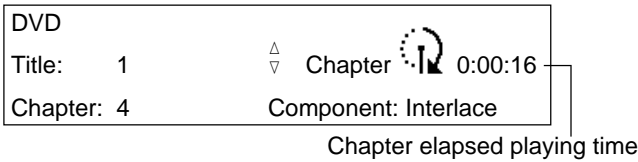

2. Press [DISPLAY].

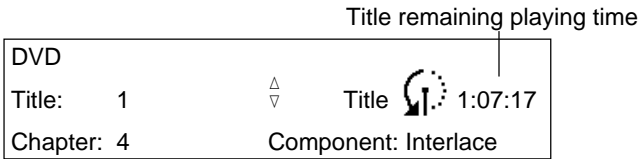

By pressing [▲] or [▼], the Title or Chapter information changes.

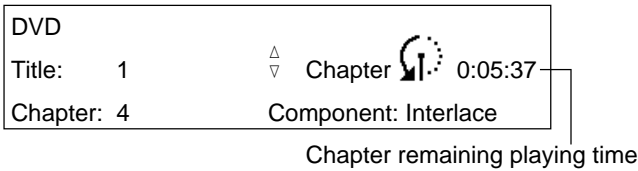

3. Press [DISPLAY].

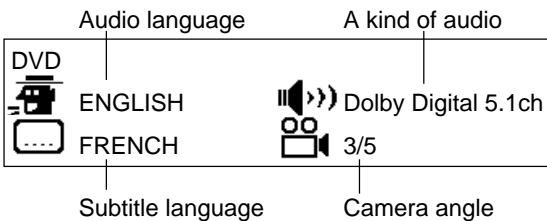

Note:
Camera angle number appears only as multi-angle disc is played back.

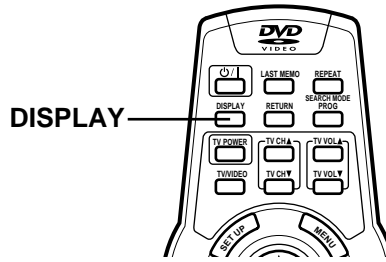

Note:
[▲] and [▼] can be used only on the active screen while "On-Screen" is working.

Example for Video CD:

1. Press [DISPLAY].

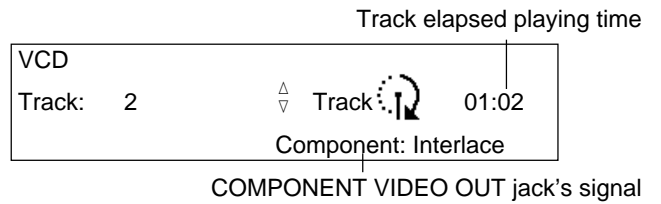

By pressing [▲] or [▼], the Track or Disc information changes.

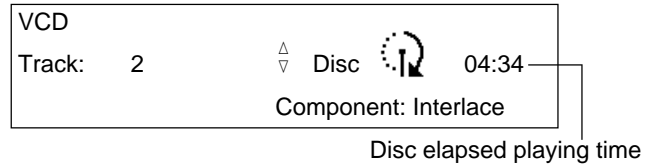

2. Press [DISPLAY].

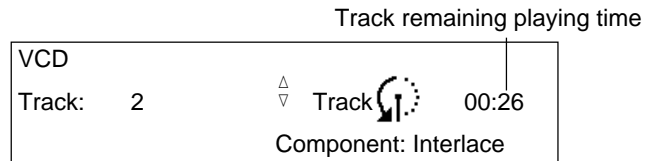

By pressing [▲] or [▼], the Track or Disc information changes.



Note:
For Music CD, please refer to "Example for Video CD" as above.

MP3 CD OPERATION

This unit can play back the CD-R/RW that have recorded music data or MP3 files. However, some CD-R/RWs can not be played back depending on the recording conditions. Before playing back MP3 CD, please read the following.

MP3 CD Information

Limitations on MP3 CD playback

- MP3 CD is the disc that standardized by ISO9660 Level 2 and ISO9660+Joliet.
- ID tag is ID3 tag Version 1.
- This unit can recognize up to 255 files or folders per disc. The CD with 256 files or folders and over is not available to this player.
- The file name must include 3 digits extension letters, "mp3".
- This unit can recognize up to 8 directory trees per disc.
- MP3 CD may not be played in the recorded order.
- As for multi-session disc, only the first session can be played.
- If the CD has both audio tracks and MP3 files, only audio tracks are played.
- It would take 30 seconds or more for this player to read MP3 files depending on its structure.

Limitations on display

- The maximum number for display is 33 letters. Available letters for display are the following: capital or small alphabets of A through Z, numbers of 0 through 9, and _ (underline).
- Other letters than those above are replaced in blank.

Notes on MP3 files

- The recommend recording setting for a high-quality sound is 44.1 kHz of sampling frequency and 128kbps of fixing bit rate.
- To play back MP3 CD in the recorded order,
 1. Please use the MP3 software with the function that can record data alphabetically or numerically.
 2. Put the name including two-digit or three-digit number like "01" "02" or "001" "002" on each file.
 3. Please refrain from making many sub-folders by preference.

CAUTION:

- Some MP3 CDs can not be played back depending on the recording conditions.
- The CD-R/RW that has no music data or non-MP3 files can not be played back.

MP3 CD Playback

1. Press [▲OPEN/CLOSE] on the unit.
 - "OPEN" appears and the disc tray opens.

Note:

To open or close the disc tray, be sure to press [▲OPEN/CLOSE]. Do not press the disc tray with your hand.

2. Place the disc with the label facing up on the disc tray.

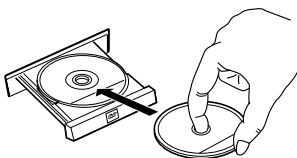

3. Press [▲OPEN/CLOSE] again. The disc tray closes.
 - "READING" appears on the display.
 - A table of contents in the root directory appears on the TV screen.

Example: (the root directory)

```
Filesystem Browse
Directory : /
MUSIC001.mp3
MUSIC002.mp3
LABEL_1/
LABEL_2/
MUSIC003.mp3
```

Please select a file.

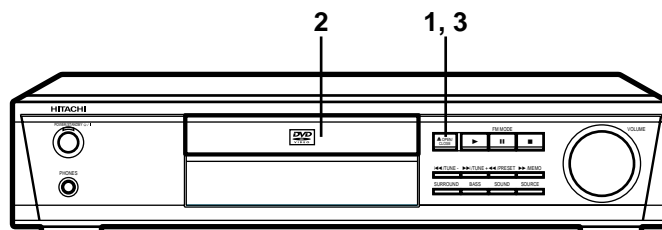

Note:

- If nothing appears on the TV screen, press [MENU].
 - If the disc is loaded with the label side downward, or if a badly scratched disc is loaded, "NO DISC" (or "NO PLAY") appears. If this occurs, load the disc correctly or replace the disc.
4. Select the desired file by pressing [▲] or [▼]. The selected file is highlighted.
 - To go on to the next directory, select the appropriate folder and press [▶]. A table of contents in the selected directory appears on the TV screen.
 - To go back to the previous directory, press [◀].
 - You can go on up to the eighth directory.

Important Note:

"⊘" may appear on the TV screen during operation. This icon means that the function is not available on the disc now.

- Press [ENTER] (or [▶]) to start playback.
 - Elapsed playing time and total playing time in current file are displayed on the TV screen.

Example: (the second directory)

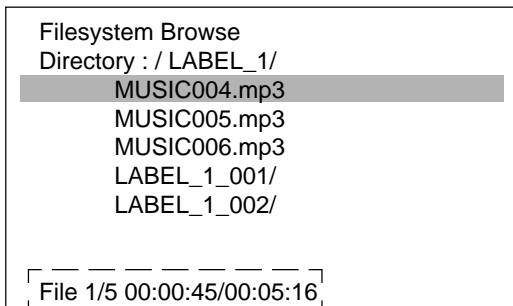

File information

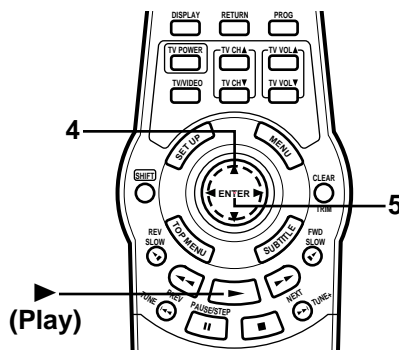

Important Note:
“⊘” may appear on the TV screen during operation. This icon means that the function is not available on the disc now.

Stopping Playback

- Press [■] once during playback. “Resume ■” briefly appears on the TV screen. When you press [▶], playback starts automatically from the point where you stopped. “▶” briefly appears on the TV screen.

Note:
Some discs may not resume playback.

- Press [■] twice during playback. “■” briefly appears on the TV screen and playback stops completely.

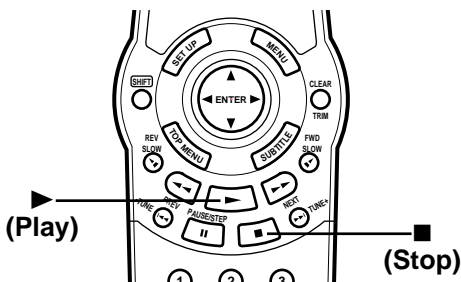

Pause

Press [PAUSE/STEP] during playback.

- “||” briefly appears on the TV screen.

Note:
The sound is muted.

Press [▶] to return to normal playback.

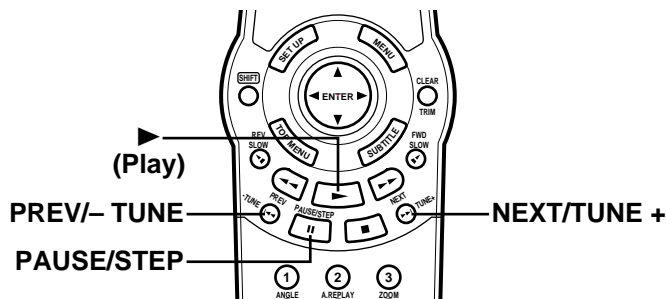

File Skip

Skipping forward

Press [NEXT/TUNE+] during playback to skip to the next file. Each time the button is pressed, a file is skipped within the same directory.

Skipping backward

Press [PREV/-TUNE] during playback to skip back to the beginning of the file currently play. Press the button again immediately to skip back to the beginning of the previous file.

Notes:

- The files with no-MP3 extension and the folders are automatically skipped.
- To roll up and down the display, press [▲] and [▼] respectively.

Repeat Playback

Press [REPEAT] during playback.

Each time the button is pressed, the repeat mode will be changed as follows.

- ↻ File (1 REP.): Repeat of file being played
- ↻ Directory (ALL REP.): Repeat all files within the current directory
- ↻ Off: Normal playback mode

Note:
Repeat playback may not work correctly with some discs.

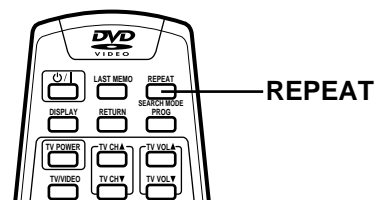

INITIAL SETTINGS

Once the initial settings have been completed, the unit can always be operated under the same conditions. The settings will be retained in the memory until they are changed, even if the power is turned off.

Common Procedures of Initial Settings

1. Press [SET UP] in the stop mode.
"SET UP MENU (Language, Display, Digital out, and Parental)" appears on the TV screen.
2. Press [▲], [▼], [◀] or [▶], then press [ENTER] to select the menu. Please refer to the on-screen instructions.
3. Press [SET UP].

Example:



OSD: ENGLISH
 AUDIO: DISC, ENGLISH, SPANISH, FRENCH, OTHERS
 SUBTITLE: DISC, ENGLISH, SPANISH, FRENCH, OTHERS
 DVD MENU: DISC, ENGLISH, SPANISH, FRENCH, OTHERS
 (DISC: It will use its first priority language setting.)

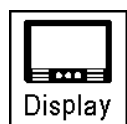

TV TYPE: 4:3 LB, 4:3 PS, 16:9
 COMPONENT OUTPUT: INTERLACE, PROGRESSIVE
 PROGRESSIVE MODE: AUTO, VIDEO, FILM

TV TYPE:

Select the appropriate setting for your TV screen size.

4:3 LB (Letterbox):

Select when a conventional TV set is connected.

When the wide screen disc is played back, the black bands appear at the top and bottom of screen.



4:3 PS (Panscan):

Select when a conventional TV set is connected.

When the wide screen disc is played back, it displays pictures cropped to fill to your TV screen. The left and right edges are cut off.

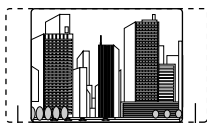

Cut off Cut off

16:9 :

Select when a wide screen TV set is connected.

Played in "FULL" size. (Setting the wide screen TV to "FULL" mode is also necessary.)

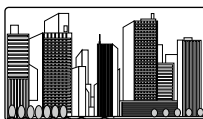

Notes:

- The screen size may differ depending on the DVD video discs.
- If you select 16:9 to get rid of the black bands on screen when wide screen disc is played back, picture may be slightly distorted.
- In some discs, even if 4:3 PS is selected, the black bands may remain on the screen.

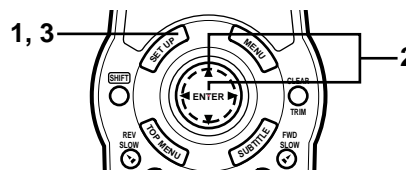

Notes:

- You cannot switch audio sound track languages if there is only one language recorded on the disc.
- When you play back a DVD video disc, the unit automatically displays the pre-selected subtitle language if it is included on the disc.
- If "OTHERS" is selected, enter the language code. (See "LANGUAGE CODE LIST" on page E33.)

COMPONENT OUTPUT:

If you use a conventional TV and connect it to the COMPONENT VIDEO OUT jacks (see Page E10), select "INTERLACE".

If you use a TV with progressive-scan capability and connect it to the COMPONENT VIDEO OUT jacks (see Page E12), select "PROGRESSIVE".

Notes:

- If the VIDEO OUT SELECT and VIDEO OUT SCAN SELECT switches are not correct position, you cannot select "COMPONENT OUTPUT: PROGRESSIVE".
- If you select "COMPONENT OUTPUT: PROGRESSIVE" when using a conventional TV, the TV screen is disturbed. In this case, turn off the power, and then set the VIDEO OUT SCAN switch to the INTERLACE position.

PROGRESSIVE MODE:

When "COMPONENT OUTPUT: PROGRESSIVE" is selected as above, select "AUTO", "VIDEO" or "FILM".

AUTO:

It automatically selects the Video Source (VIDEO) or Film Source (FILM). Normally, select this mode.

VIDEO (Video Source):

Major DVD-Video sources consist of video source and film source. Video source is DVD-Video recording produced by converting TV programs like drama or animation video (30 frames per second, 60 fields) into DVD video disc.

FILM (Film Source):

Major DVD-Video sources consist of video source and film source. Film source is DVD-Video recording produced by converting movie films (24 frames per second) into DVD video disc.

Notes:

- Initial setting is "AUTO".
- If picture flickering occurs at "AUTO" mode, select "VIDEO" or "FILM".



D-RANGE CONTROL: OFF, ON
FRONT SPEAKER: SMALL, LARGE
CENTER SPEAKER: SMALL, LARGE
SURROUND SPEAKER: SMALL, LARGE
SUBWOOFER: YES, NO

When the supplied speakers are connected, you must set the speaker settings as follows:

D-RANGE CONTROL (Dynamic range control):

ON: It will compress the dynamic range. It may have no effect with some discs.
OFF: Sound with a wide dynamic range.

FRONT SPEAKER:

When using the supplied speakers, select “SMALL”.

CENTER SPEAKER/SURROUND SPEAKER:

When using the supplied speakers, select “SMALL”.

SUBWOOFER:

When using the supplied speaker, select “YES”. If not, select “NO”.



ENTER PASSWORD
 Enter a number in 4 digits, then press “ENTER”.

↓

To confirm, enter password again, then press “ENTER”.

Invalid password
 Enter a number in 4 digits, then press “ENTER”.

PARENTAL LEVEL: 1, 2, 3, 4, 5, 6, 7, 8, OFF

CHANGE PASSWORD:
CHANGE PASSWORD
 Enter a number in 4 digits, then press “ENTER”.

↓

To confirm, enter password again, then press “ENTER”.

Parental Control

MPAA (Motion Picture Association of America) Guideline is a rating system that provides advanced cautionary information to parent about the content of movie programs.

The parental lock level is equivalent to the following MPAA Rating System.

- Level 7: NC-17 (No one 17 and under admitted)
- Level 6: R (Restricted)
- Level 4: PG13 (Parental guidance cautioned)
- Level 3: PG (Parental guidance suggested)
- Level 1: G (General audiences)

Some DVD discs contain a restriction level which enables parents to prevent playback of discs by children. This unit is equipped with a password designed to prevent children changing the level.

You cannot play DVD video discs rated higher than the level you selected unless you cancel the parental lock function. For example, when you select level “5”, the DVD video player will not play discs with ratings of “6”, “7” or “8”. The information will appear on the TV screen.

If you forget the password...
 Enter “788444” even if 4 digits box appears, then press [ENTER] to clear the current password.
 Enter a new password and set the parental lock level again.

Note:
 DVD video discs may or may not respond to the parental lock settings. Make sure this function works with your DVD video discs.

LANGUAGE CODE LIST

Enter the appropriate code number for the initial settings "AUDIO", "SUBTITLE" and "DVD MENU".

Code	Abbreviation of the language	Language	Code	Abbreviation of the language	Language	Code	Abbreviation of the language	Language
6565	aa	Afar	7369	ie	Interlingue	8278	rn	Kirundi
6566	ab	Abkhazian	7375	ik	Inupiak	8279	ro	Romanian
6570	af	Afrikaans	7378	in	Indonesian	8285	ru	Russian
6577	am	Amharic	7383	is	Icelandic	8287	rw	Kinyarwanda
6582	ar	Arabic	7384	it	Italian	8365	sa	Sanskrit
6583	as	Assamese	7387	iw	Hebrew	8368	sd	Sindhi
6589	ay	Aymara	7465	ja	Japanese	8371	sg	Sangro
6590	az	Azerbaijani	7473	ji	Yiddish	8372	sh	Serbo-Croatian
6665	ba	Bashkir	7487	jw	Javanese	8373	si	Singhalese
6669	be	Byelorussian	7565	ka	Georgian	8375	sk	Slovak
6671	bg	Bulgarian	7575	kk	Kazakh	8376	sl	Slovenian
6672	bh	Bihari	7576	kl	Greenlandic	8377	sm	Samoan
6673	bi	Bislama	7577	km	Cambodian	8378	sn	Shona
6678	bn	Bengali; Bangla	7578	kn	Kannada	8379	so	Somali
6679	bo	Tibetan	7579	ko	Korean	8381	sq	Albanian
6682	br	Breton	7583	ks	Kashmiri	8382	sr	Serbian
6765	ca	Catalan	7585	ku	Kurdish	8383	ss	Siswati
6779	co	Corsican	7589	ky	Kirghiz	8384	st	Sesotho
6783	cs	Czech	7665	la	Latin	8385	su	Sundanese
6789	cy	Welsh	7678	ln	Lingala	8386	sv	Swedish
6865	da	Danish	7679	lo	Laothian	8387	sw	Swahili
6869	de	German	7684	lt	Lithuanian	8465	ta	Tamil
6890	dz	Bhutani	7686	lv	Latvian, Lettish	8469	te	Telugu
6976	el	Greek	7771	mg	Malagasy	8471	tg	Tajik
6978	en	English	7773	mi	Maori	8472	th	Thai
6979	eo	Esperanto	7775	mk	Macedonian	8473	ti	Tigrinya
6983	es	Spanish	7776	ml	Malayalam	8475	tk	Turkmen
6984	et	Estonian	7778	mn	Mongolian	8476	tl	Tagalog
6985	eu	Basque	7779	mo	Moldavian	8478	tn	Setswana
7065	fa	Persian	7782	mr	Marathi	8479	to	Tonga
7073	fi	Finnish	7783	ms	Malay	8482	tr	Turkish
7074	fj	Fiji	7784	mt	Maltese	8483	ts	Tsonga
7079	fo	Faeroese	7789	my	Burmese	8484	tt	Tatar
7082	fr	French	7865	na	Nauru	8487	tw	Twi
7089	fy	Frisian	7869	ne	Nepali	8575	uk	Ukrainian
7165	ga	Irish	7876	nl	Dutch	8582	ur	Urdu
7168	gd	Scots Gaelic	7879	no	Norwegian	8590	uz	Uzbek
7176	gl	Galician	7967	oc	Occitan	8673	vi	Vietnamese
7178	gn	Guarani	7977	om	(Afan) Oromo	8679	vo	Volapük
7185	gu	Gujarati	7982	or	Oriya	8779	wo	Wolof
7265	ha	Hausa	8065	pa	Punjabi	8872	xh	Xhosa
7273	hi	Hindi	8076	pl	Polish	8979	yo	Yoruba
7282	hr	Croatian	8083	ps	Pashto, Pushto	9072	zh	Chinese
7285	hu	Hungarian	8084	pt	Portuguese	9085	zu	Zulu
7289	hy	Armenian	8185	qu	Quechua			
7365	ia	Interlingua	8277	rm	Rhaeto-Romance			

Note:

In some cases, the abbreviation of the language spells out in full.

ENJOYING VIDEO SOURCES

1. Press [SOURCE] to select "VIDEO 1" or "VIDEO 2".

2. Follow the instructions supplied with VCR or other compatible/video component.

LISTENING TO THE RADIO

To turn the unit on and listen to the last received station, press [TU/BAND] on the remote control.

Automatic/Manual Tuning

1. Press [SOURCE] (or [TU/BAND] on the remote control) to select FM or AM.

Automatic tuning

Press [▶▶/TUNE+] or [◀◀/TUNE -] (or [NEXT/TUNE+] or [PREV-/TUNE] on the remote control) for at least 1 second to tune in a station. The unit will scan up or down the band and receive the next receivable station. Press the button again to continue.

Manual tuning

Press [▶▶/TUNE+] or [◀◀/TUNE -] (or [NEXT/TUNE+] or [PREV-/TUNE] on the remote control) briefly until the desired frequency is displayed.

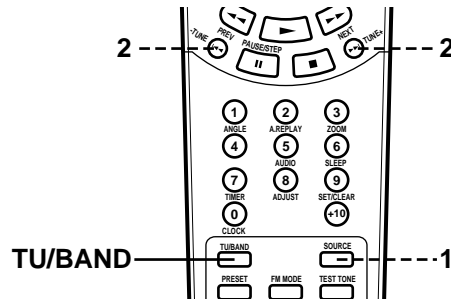
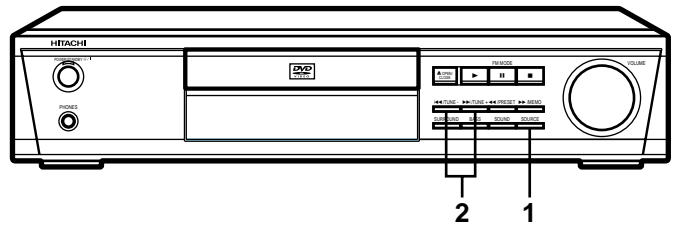
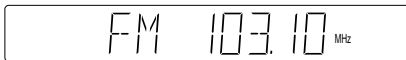

To Preset Stations

Up to 20 FM and 10 AM stations can be preset.

Automatic presetting (APT)

1. Press [SOURCE] (or [TU/BAND] on the remote control) to select FM or AM.

2. Press [▶▶/MEMO] for at least 3 seconds. "PROG." blinks.

The automatic tuning mode is set and automatic presetting begins from the low end of the band.

When 20 FM or 10 AM stations have been preset or the high end of the band is reached, automatic presetting stops. "PROG." disappears and the station memorized on channel 1 will be heard.

3. To preset stations on the other band, follow steps above.

Note:

If APT is activated, all previously programmed stations of the band will be cleared and new stations will be programmed.

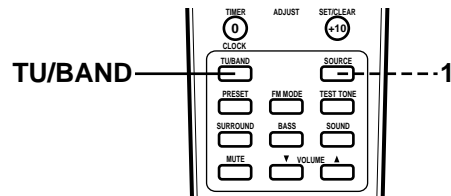
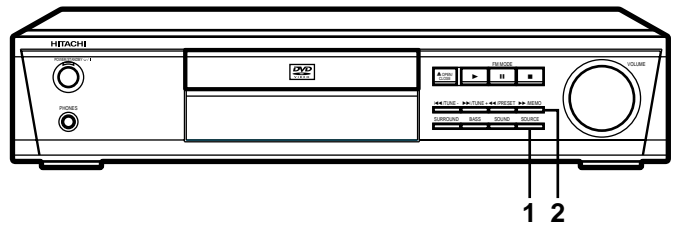

Manual presetting

1. Tune in the station to be preset as described in "Automatic/Manual Tuning".
2. Press [▶▶/MEMO]. "PROG." blinks.

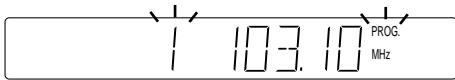

3. While "PROG." is blinking, press [◀◀/PRESET] (or [PRESET] on the remote control) to select the channel to be preset.
 - In this example, the channel is "9".



4. While "PROG." is blinking, press [▶▶/MEMO].
 - In this example, "103.1 MHz" FM station is preset on FM channel 9.



5. Repeat steps above to add more preset stations.
 - When presetting a new station, the previous preset station is cleared.

Listening to Preset Stations

1. Press [SOURCE] (or [TU/BAND] on the remote control) to select FM or AM.
2. Press [◀◀/PRESET] (or [PRESET] on the remote control) briefly to select the desired channel.
 - The number buttons on the remote control can also be used.
 - Example: To select No.9, press [0], then [9].
 - Note: Do not press the [+10] button.

Preset scan tuning

1. Press [SOURCE] (or [TU/BAND] on the remote control) to select FM or AM.
2. Press [◀◀/PRESET] (or [PRESET] on the remote control) for at least 1 second.
 - The channel number appears.
 - The preset stations are selected in sequence for approximately five seconds each.
3. Press [◀◀/PRESET] (or [PRESET] on the remote control) when the desired station has been selected. Preset scanning will stop.

To receive FM stereo broadcasts

Make sure that "MONO" is not displayed. If "MONO" appears, press [FM MODE] to turn the "MONO" indication off. "ST" appears when an FM stereo broadcast is received.

- If the signal from an FM stereo station is weak and reception is poor, press [FM MODE] to change to monaural reception. The reception may be improved, but the sound will be monaural.

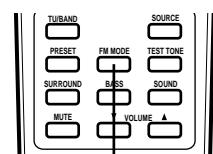
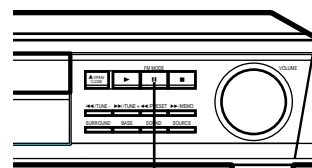
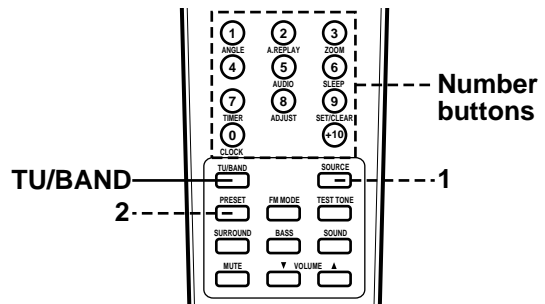
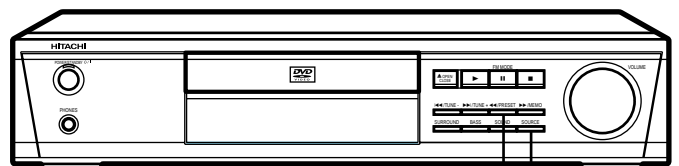
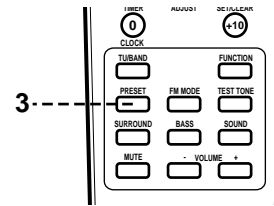
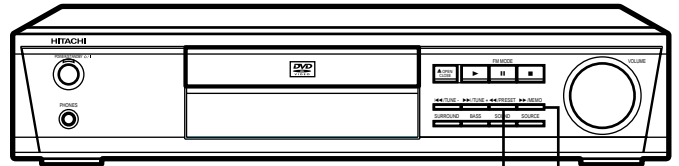

TIMER OPERATION (Using the Remote Control)

Before setting the timer, make sure that the clock is set to the present time. See "ADJUSTING THE CLOCK".

Using the Wake Up Timer

Set the on and off times, source to be used and volume level. Operation will start with the selected source at the on time. The power will be turned off at the off time.

The timer will function every day unless it is released.

Preparation

- Select the source for timer operation and prepare the sources to be used.
- If the tuner is selected, tune in to the desired band and station.
- Adjust the volume level as desired.

Operation

1. Press [TIMER] while holding [SHIFT] down.



The previous timer on time setting appears.

2. Press [ADJUST] while holding [SHIFT] down within 10 seconds.

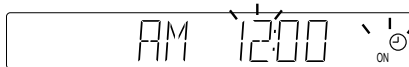

3. Set the hours of timer on time by pressing [NEXT/TUNE+] or [PREV/-TUNE], then press [ADJUST] while holding [SHIFT] down.



Set the minutes in the same way.

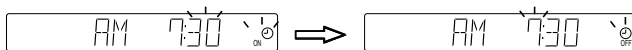

The timer off time setting appears.

4. Set the timer off time as described in step 3. "⌚" blinks.
5. While "⌚" is blinking, press [SOURCE] to select the source to be used.
6. Press [ADJUST] while holding [SHIFT] down. The timer operation standby mode is activated. "⌚" remains lit.
7. Press [⏻/I] to turn off the power. The STANDBY indicator lights.

When the timer ON time arrives, the power is turned on automatically.

- "⌚" appears while timer operation is engaged.
- When the timer OFF time arrives, the power turns off and the timer is set to the standby mode. Timer operation repeats this cycle every day.
- If [⏻/I] is pressed during timer operation, the power is turned off and the timer is set to the standby mode.

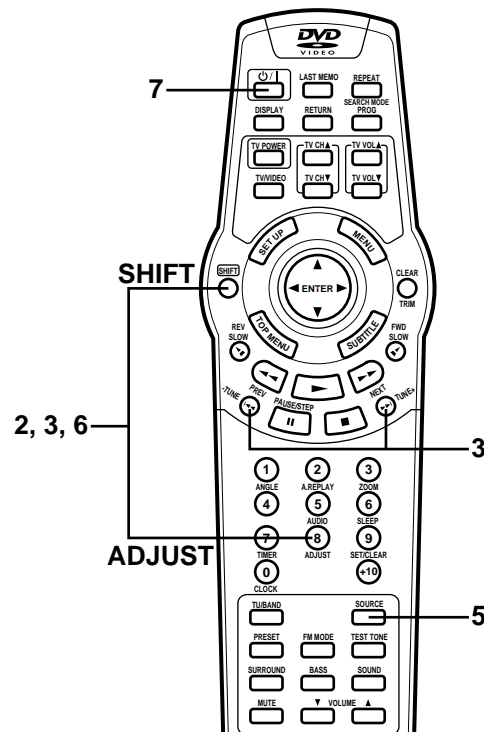
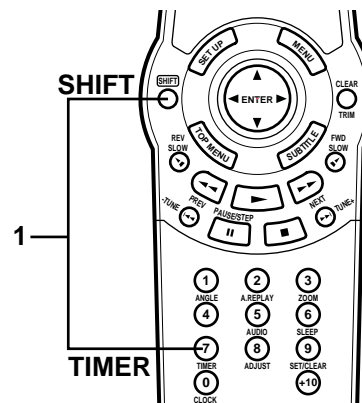

To check the timer settings

Press [TIMER] repeatedly while holding [SHIFT] down. The timer settings are displayed in the following order:

On time → Off time → Source

To change the settings

1. Press [TIMER] while holding [SHIFT] down to select the setting to be changed.
2. Press [ADJUST] while holding [SHIFT] down so that the display blinks.
3. Change the setting as explained above.

To release the timer

1. After turning the power on, press [TIMER] while holding [SHIFT] down.
2. Press [SET/CLEAR] while holding [SHIFT] down.

Note:

- If [SET/CLEAR] is pressed while holding [SHIFT] down, while the timer is being set, the original display returns.
- The timer mode is released if a power failure occurs during timer controlled operation.
- The timer may not operate if a power failure occurs during timer operation standby mode.

Using the Sleep Timer

The sleep timer automatically switches off the power after a preset time has elapsed. The volume will gradually be reduced (fade-out) during the 1 minute period before the unit turns off. There are 9 time periods available: 90, 80, 70, 60, 50, 40, 30, 20, and 10 minutes.

Press [SLEEP] repeatedly while holding [SHIFT] down to select the desired sleep time. "SLEEP" appears on the display. After several seconds, the original display returns and the brightness of the display reduces.

To check the remaining sleep time

Press [SLEEP] once while holding [SHIFT] down. After several seconds, the original display returns.

To release the sleep timer while in operation

Press [SLEEP] repeatedly while holding [SHIFT] down until "SLEEP" disappears. The timer is also released if the power is switched off.

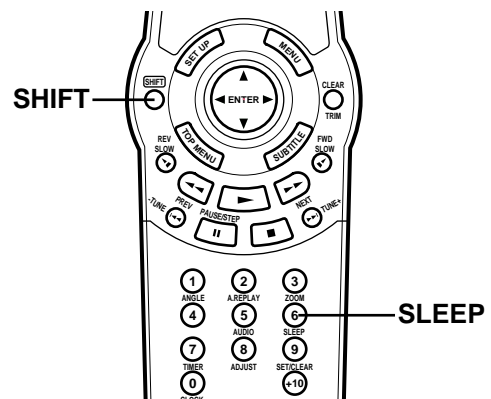
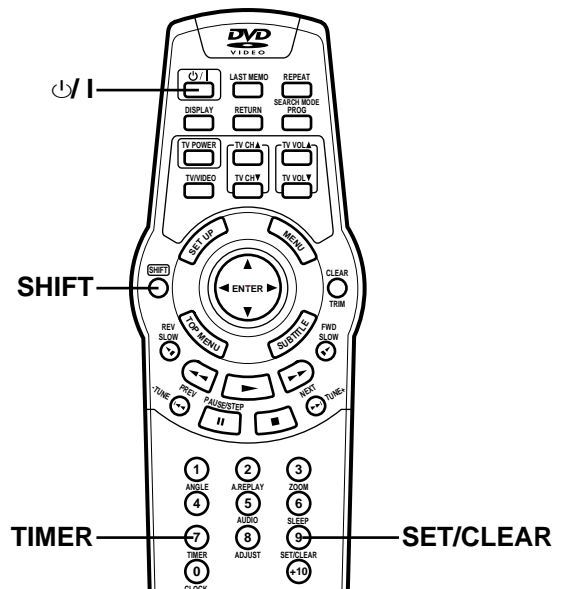

MAINTENANCE

WARNING:

FOR YOUR PERSONAL SAFETY, BE SURE TO DISCONNECT THE AC POWER CORD BEFORE PROCEEDING WITH ANY MAINTENANCE OR CLEANING.

Cleaning the cabinet

Use a clean soft cloth moistened with plain lukewarm water and wrung dry. Never use benzol, benzene or other strong chemical cleaners since these could damage the finish of your unit. It is important that no liquid reaches the inside of the unit.

TROUBLESHOOTING GUIDE

If you have followed the instructions and are having difficulty operation the unit, locate the SYMPTOM in the left column below. Check the corresponding POSSIBLE CAUSE and CORRECTIVE ACTION columns to locate and remedy the problem.

SYMPTOM	POSSIBLE CAUSE	CORRECTIVE ACTION
No power.	No power plug connection at the AC wall outlet.	Insert the power plug into the AC wall outlet.
The power is on, but the player does not work.	No disc is loaded.	Load a disc.
No picture.	An unplayable disc is loaded.	Load a playable disc. (Check the disc logo, type, color system and Regional code.)
	The TV is not set to receive signal from the unit.	Select the correct input function on the TV.
	The video cable is not connected.	Connect the video cable into the jack.
No sound.	Volume control is set to minimum.	Turn up the volume.
	The wrong function is selected.	Select the correct function.
	Faulty speaker connections.	Connect the speaker wires firmly to the speaker terminals.
Sound is heard from only one speaker.	Faulty connection of speaker wires.	Connect the speaker wires firmly to the speaker terminals.
Picture is disturbed when using a conventional TV.	The VIDEO OUT SCAN SELECT switch is set to the SELECTABLE position (using COMPONENT VIDEO OUT jacks).	Turn off the power and set the switch to the INTERLACE position.
The playback picture is poor.	An unplayable disc is loaded.	Load a playable disc. (Check the disc logo, type, color system, and regional code.)
Part of On-Screen-Display is cut off.	Incorrect aspect ratio setup on TV.	Refer to the instruction manual of your TV.
"⊗" appears on the TV screen.	The selected function does not operate on the disc now.	The feature or action cannot be completed at this time because: <ul style="list-style-type: none"> • The feature is not available at the moment. • The DVD software restricts it. • The DVD software doesn't support the feature (e.g., angles).
The player does not start playback.	No disc is loaded.	Load a disc.
	An unplayable disc is loaded.	Load a playable disc. (Check the disc logo, type, color system, and regional code.)
	The disc is loaded with the label side down.	Load the disc on the disc tray correctly.
	The disc is dirty.	Clean the disc or replace it.
	"PARENTAL" is set.	Cancel the parental lock function or change the rating level. Reset it after play. (See Page E32.)
The operation or display is not normal.	The unit must be reset.	<ol style="list-style-type: none"> 1. Disconnect the power cord. 2. While pressing both BASS and SOUND buttons at the same time, connect the power cord. "RESET" appears. (See Page E3.)
Flickering :ST".	Weak signal.	Reorient the FM antenna lead wire or install an outdoor FM antenna.
The remote control does not work properly.	The batteries in the remote control are weak, or installed incorrectly.	Check the battery polarity (+ or -). Replace the batteries.
	The remote control is not aimed at the remote sensor window.	Aim the remote control at the remote sensor window.

SERVICING:

Should this product require service, refer to the Hitachi DVD product limited warranty.

If you do not have a convenient Hitachi service facility nearby, call the toll-free number 1-800-HITACHI (1-800-448-2244). (Please see the back page of this instruction manual.)

SPECIFICATIONS

Amplifier Section

Main Amplifier (Stereo mode)

Continuous minimum sine wave RMS power output per channel into 8 ohms at 1kHz with no more than 10% total harmonic distortion 40 Watts

Main Amplifier (Dolby Digital mode)

Continuous minimum sine wave RMS power output per channel into 8 ohms at 1kHz with no more than 10% total harmonic distortion (with Center/Surround/Subwoofer amplifier off) 40 Watts

Center Channel Amplifier (Center)

Continuous minimum sine wave RMS power output into 8 ohms at 1kHz with no more than 10% total harmonic distortion (with Main/Surround/Subwoofer amplifier off) 40 Watts

Surround Channel Amplifier (Surround)

Continuous minimum sine wave RMS power output per channel into 8 ohms at 1kHz with no more than 10% total harmonic distortion (with Main/Center/Subwoofer amplifier off) 40 Watts

Subwoofer Channel Amplifier (Subwoofer)

Continuous minimum sine wave RMS power output into 8 ohms at 100Hz with no more than 10% total harmonic distortion (with Main/Center/Surround amplifier off) 40 Watts

Input level, Output level and impedance:

VIDEO 1:

VIDEO IN: 1.0 Vp-p (75 Ω)

AUDIO IN (L/R): 300 mV/50 k Ω

VIDEO OUT: 1.0 Vp-p (75 Ω)

AUDIO OUT (L/R): 300 mV/2.2 k Ω

VIDEO 2:

VIDEO IN: 1.0 Vp-p (75 Ω)

AUDIO IN (L/R): 300 mV/50 k Ω

Outputs:

FRONT SPEAKERS (L/R): 8 Ω

CENTER SPEAKER: 8 Ω

SURROUND SPEAKERS (L/R): 8 Ω

SUBWOOFER: 8 Ω

COMPONENT VIDEO OUT:

Y: 1.0 Vp-p (75 Ω)

C_B/P_B: 0.7 Vp-p (75 Ω)

C_R/P_R: 0.7 Vp-p (75 Ω)

MONITOR OUT S-VIDEO OUT:

Y: 1.0 Vp-p (75 Ω)

C: 0.286 Vp-p (75 Ω)

MONITOR OUT VIDEO: 1.0 Vp-p (75 Ω)

DVD Video Player Section

Type:

DVD Video player

Signal format:

NTSC color

Laser:

Semiconductor laser, wavelength 650 nm/790 nm

Frequency range (digital audio):

4 Hz to 44 kHz (DVD fs: 96 kHz)

Signal to noise ratio:

More than 105 dB

Harmonic distortion (digital audio):

0.003 %

Wow and flutter:

Below measurable level

Tuner Section

(FM)

Frequency range:

87.9 MHz ~ 107.9 MHz (200 kHz steps)

Usable sensitivity:

20.2 dBf (mono)

(AM)

Frequency range:

520 kHz ~ 1,710 kHz (10 kHz steps)

Usable sensitivity:

500 μ V/m (AM loop antenna)

General

Power requirements:

AC 120V, 60Hz

Power consumption:

230 Watts

Dimensions (W x H x D):

Approx. 17.1" x 3.5" x 15" (435 x 90 x 382 mm)

Weight:

Approx. 16.8 lbs (7.6 kg)

Speaker System

Front left, Front right, Center, Surround left, and Surround right speakers (DV-SS522, magnetic shield)

Unit used:

3.1" (8 cm) diameter, Cone type, Full range

Maximum music power handling capacity:

60 Watts

Nominal impedance:

8 Ω

Dimensions (W x H x D):

Approx. 5.9" x 4.3" x 4.5" (150 x 110 x 115 mm)

Weight:

Approx. 1.6 lbs (0.73 kg)/speaker

Subwoofer (DV-SW522)

Unit used:

5.1" (13 cm) diameter, Cone type

Maximum music power handling capacity:

60 Watts

Nominal impedance:

8 Ω

Dimensions (W x H x D):

Approx. 7.1" x 15.6" x 11.8" (180 x 395 x 300 mm)

Weight:

Approx. 12.6 lbs (5.7 kg)

IMPORTANT INFORMATION

Because its products are subject to continuous improvement, Hitachi reserves the right to modify product designs and specifications without notice and without incurring any obligation.

HITACHI

*service
hotline*

To locate an authorized
HITACHI service facility in
the continental U.S.A

DIAL TOLL FREE
7 days a week, 24 hours a day

800 HITACHI

1-800-448-2244

Hitachi has made every effort to assure you hours of trouble free operation from your unit. However, should you require service, a network of Hitachi Authorized Service Facilities has been established in all 50 states and Puerto Rico. Each facility will provide you with convenient and expedient assistance. Our service "Hotline" operator will direct you to the Hitachi Authorized Service Facility nearest you. Just present proof of purchase and/or delivery receipts to the Hitachi Authorized Service Facility and service will be rendered in accordance with the terms of the limited warranty as stated on your warranty card or operating guide.

Should you have any questions regarding in-warranty service, operation or technical assistance, please contact:

HITACHI AMERICA, LTD.
HOME ELECTRONICS DIVISION

1855 Dornoch Court,
San Diego, California 92154-7255,
Tel: 1-800-HITACHI
(1-800-448-2244)

HITACHI CANADA LTD.
DIGITAL MEDIA DIVISION

6740 Campobello Road, Mississauga,
Ontario L5N 2L8 CANADA
Tel: 1-800-HITACHI
(1-800-448-2244)

during the business hours
Monday – Friday EST 9:00am~7:00pm
Saturday EST 9:00am~5:00pm

durant les heures de bureau :
Lundi au Vendredi 9:00am~7:00pm (h.n.e.)
Samedi 9:00am~5:00pm (h.n.e.)