

another innovation from
SONIC | **blue**[™]
www.sonicblue.com



GO.VIDEO[®]
DHT7000
User's Guide

Unpack Your DVD System

- DHT7000 main unit (1)
- Remote control (1)
- 1.5V AA alkaline batteries (2)
- Satellite speakers 6Ω 30w (5)
- Passive Subwoofer 6Ω 60w (1)
- 16' Speaker cables for L/C/R (3)
- 26' Speaker cables for LS/Sub/RS (3)
- Video cable (1)
- AM loop antenna (1)
- FM wire antenna (1)
- User's guide (1)
- Read Me First/Quick Reference Guide
- Warranty registration card

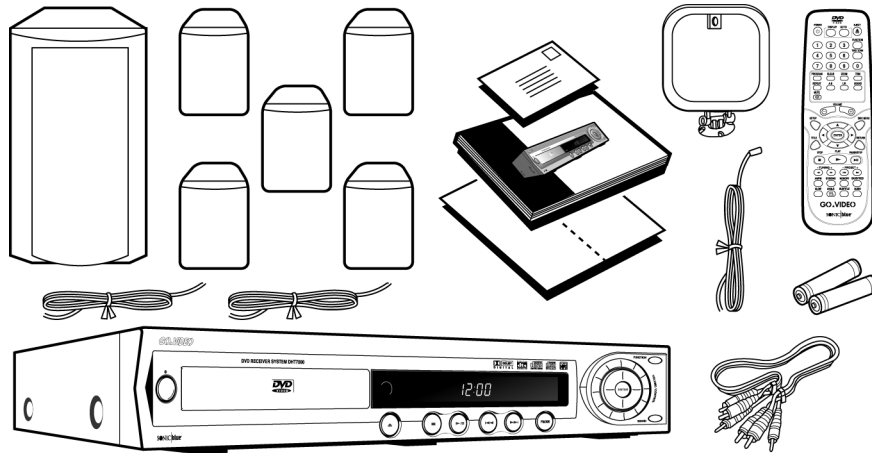

Insert Batteries

- 1 Remove battery cover.
- 2 Insert two 1.5V AA batteries, paying attention to the correct polarities (+/-).
- 3 Replace cover.

Copyright/Trademarks

© 2002. SONICblue Incorporated. All rights reserved.

Go-Video is a registered trademark of SONICblue Corporation. “Dolby”, “Pro Logic”, and the double D symbol are trademarks of Dolby Laboratories. “DTS” and “DTS Digital Surround” are trademarks of Digital Theater Systems, Inc. All other brand and product names are trademarks or registered trademarks of their respective companies. This product incorporates copyright protection technology that is protected by method claims of certain US patents, other intellectual property rights owned by Macrovision Corporation, and other rights owners. Use of this copyright protection technology must be authorized by Macrovision Corporation, and is intended for home and other limited viewing users only unless otherwise authorized by Macrovision Corporation. Reverse engineering or disassembly is prohibited.

SONICblue Incorporated shall not be liable for any errors contained herein or for any damages arising out of or related to this document or the information contained herein, even if SONICblue has been advised of the possibility of such damages. This document is intended for informational and instructional purposes only. SONICblue reserves the right to make changes in the specifications and other information contained in this document without prior notification. SONICblue disclaims any obligation to update the information contained herein.

Printed in China.

Table of Contents

1 - Getting Started 1

Welcome	1
• Compatible Discs.....	1
System Overview	2
• Remote Control	2
• Front Panel Controls.....	4
• Front Panel Display	5
• Rear Panel.....	6

2 - Connections 7

Connecting the System	7
• Step 1 - Connect TV	7
• Step 2 - Place Speakers.....	7
• Step 3 - Connect Speakers.....	8
• Step 4 - Connect AM Loop Antenna.....	8
• Step 5 - Connect FM Wire Antenna.....	9
• Step 6 - Connect External Audio/Video Components (Optional).....	9
• Step 7 - Power on the System.....	10

3 - Setup 11

Setup Menu Overview	11
• Setup Menu Categories.....	11
• Setup Menu Navigation.....	11
Language Setup	12
• OSD Menu Language.....	12

• Subtitle Language.....	12
• Audio Language	13
• Disc Menu Language.....	13
Video Setup	14
• TV Aspect.....	14
Audio Setup	14
• Dolby Digital Setting.....	15
• DTS Setting	15
• MP3 Setting	16
• CD/VCD Setting.....	16
More Audio Setup	17
• Pro Logic Setting.....	17
• L/R Speaker Setting.....	18
Rating Setup	18
• Setting the Password & Rating Level.....	18
Speaker Setup	19
• Adjusting Speaker Balance/Levels.....	19
4 - Basic Operations 21	
First Things First	21
Basic Disc Playback	21
• Playing a DVD, CD or VCD	21
• Disc Menu Navigation.....	22
• Additional Disc Playback Options	22
Basic Tuner Operation	23
• Presetting Radio Stations.....	23
• Listening to the Radio	24
• Adjusting Stereo/Mono	24
• Adjusting Bass/Treble	24

5 - Advanced Features 25

Special Playback Features	25
• Display	25
• Go To	25
• Title	26
• Angle	26
• Zoom	26
• Subtitle	27
• Audio	27
• Repeat	28
• A-B Repeat	28
• Program Playback	29
• Enhance Video Setting	29
VCD Playback	30
• Playing VCDs	30
• Sound	30
• L/R Button	30
MP3 Playback	31

6 - Help 33

Troubleshooting	33
• Customer Service Information	33
• Frequently Asked Questions	33
Technical Specifications	35
Warranty	37
Safety	38
• Important Safety Instructions	38
• Safety/Regulatory Information	41

• Notes about Discs	42
Index 43	
Setup Menu Tree	45

:: Welcome

Welcome to the DHT7000, the all-in-one digital home theater system, complete with a DVD player, AM/FM receiver and built-in amplifier! Now you can enjoy all your favorite home entertainment media in one integrated package, including:

- DVD movies in Dolby Digital 5.1 and DTS Digital Surround
- Audio/Video CDs
- MP3 files recorded on CD-R or CD-RW
- Plus all your favorite AM/FM radio stations

In case warranty service is required, please take a moment to attach your receipt to this manual and write down your Serial Number, located on the back panel of the DVD System: _____.

Compatible Discs

This DVD System can play discs with the following logos:

- DVD Video
- Dolby Digital 5.1
- DTS Digital Surround
- Audio CD (CDDA)
- Video CD (VCD/SVCD)
- MP3 files on CD-R/CD-RW



- **Region 1** - Your system has a region code printed on the back of the unit and will only play DVD discs labeled with the same region code.
- **Energy Star** - As an ENERGY STAR partner, SONICblue, Inc. has determined that this product meets the ENERGY STAR guidelines for energy efficiency.
- CD-ROM, Photo CD, DVD Audio, DVD-R and DVD-ROM discs cannot be played on this system.



:: System Overview

Remote Control

- 1 DISPLAY** Press to display disc information during playback. Press once for elapsed/remaining time, twice for detailed disc information, and three times to turn off the display.
- 2 POWER** Press to switch between power on and Standby mode.
- 3 0-9** Use to key in numbers; e.g., chapter/track numbers in Go To mode.
- 4 CLEAR** Press to clear Program Play.
- 5 PROGRAM** Press to set up Program Play (custom playback order).
- 6 A-B** Press to repeat a segment between two points (A and B).
- 7 REPEAT** Press to repeat all or individual chapters/tracks.
- 8 MUTE** Press to toggle mute on/off to mute all audio output, including amplified output and downmixed channels.
- 9 VOLUME +/-** Press to adjust the volume/speaker level.
- 10 SETUP** While the disc is stopped, press to display the Setup menu for the DVD system. While a disc is playing, press to adjust brightness and edges; see page 29.
- 11 ENTER** Press to confirm menu settings.
- 12 TITLE** Press to display DVD title menus (for discs with multiple titles only).
- 13 PLAY** Press to start playback.
- 14 STOP** Press to stop and hold playback (press PLAY to resume). Press STOP twice to stop playback and reset playback to the beginning.
- 15 TUNING-/SCAN BACKWARD** ◀◀ In the Tuner function, press to tune down the frequency spectrum. In the DVD function, press repeatedly to scan backward at 2x, 4x, 8x or 20x normal speed.
- 16 TUNING+/SCAN FORWARD** ▶▶ In the Tuner function, press to tune up the frequency spectrum. In the DVD function, press repeatedly to scan forward at 2x, 4x, 8x or 20x normal speed.
- 17 AM/FM** Press to enter the Tuner function and switch between the AM and FM bands.
- 18 ST/MONO** Press to set the Tuner audio to Stereo or Mono.

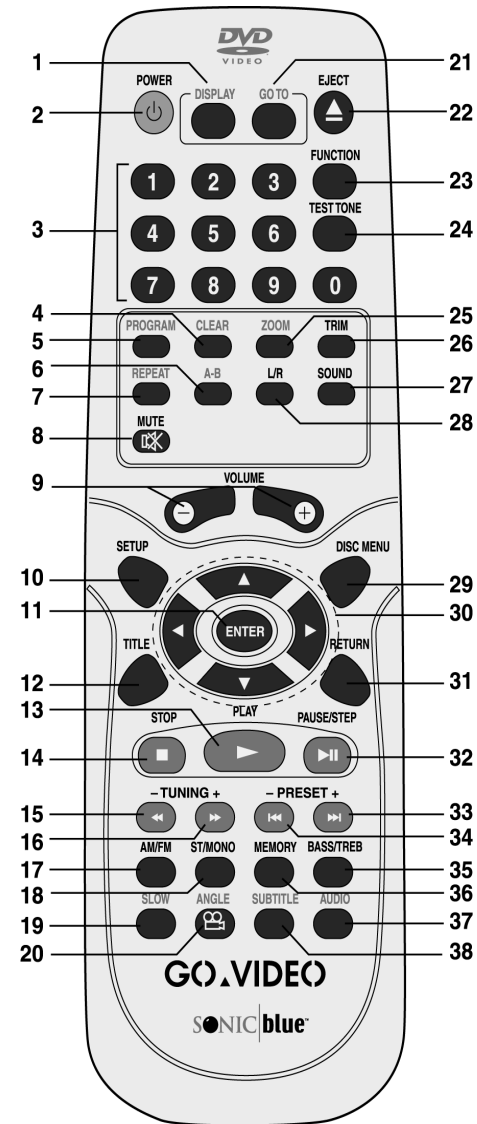

- 19 SLOW** Press repeatedly for slow motion playback at 1/2, 1/4, 1/6 and 1/7 of normal speed.
- 20 ANGLE** Press to view alternative angles during DVD playback (if available).
- 21 GO TO** Press to jump to a specific time, title, chapter or track.
- 22 EJECT** Press to open and close the DVD disc tray.
- 23 FUNCTION** Press to switch control among the four main functions: DVD, Tuner, Video 1 and Video 2.
- 24 TEST TONE** Press to initiate a Test Tone generator that plays for a few seconds in each speaker to help you fine tune speaker balance and levels. Press again to toggle off.
- 25 ZOOM** Press to zoom in at 3 levels of magnification.
- 26 TRIM** Press repeatedly to adjust trim levels (volume) for each speaker individually. Can be used during playback.
- 27 SOUND** Press to select among various preset EQ settings, such as FLAT, POP, ROCK, JAZZ or CLASSIC.
- 28 L/R** (CD & VCD only) Press to set the VCD audio output to left channel, right channel, mix, or stereo.
- 29 DISC MENU** Press to view the DVD disc menu.
- 30 ARROW KEYS ▲/▼/◀/▶** Press to navigate in on-screen menus.
- 31 RETURN** Press to save and exit on-screen menus.
- 32 PAUSE/STEP** Press once to pause playback. Press repeatedly to step forward one frame at a time.
- 33 PRESET+/SKIP FORWARD ▶▶|** In the Tuner function, press to skip to the next Preset. In the DVD function, press to skip to the next chapter or track.
- 34 PRESET-/SKIP BACKWARD |◀◀** In the Tuner function, press to skip to the previous Preset. In the DVD function, press to skip to the previous chapter or track.
- 35 BASS/TREB** Press to adjust bass and treble in the Tuner, VCD, CD, MP3 and Video 1/2 functions. Use the VOLUME +/- keys to adjust bass and treble.
- 36 MEMORY** Press to memorize a Preset in the Tuner function.
- 37 AUDIO** Press to select among available audio tracks/formats.
- 38 SUBTITLE** Press to select among available subtitle languages.

Front Panel Controls

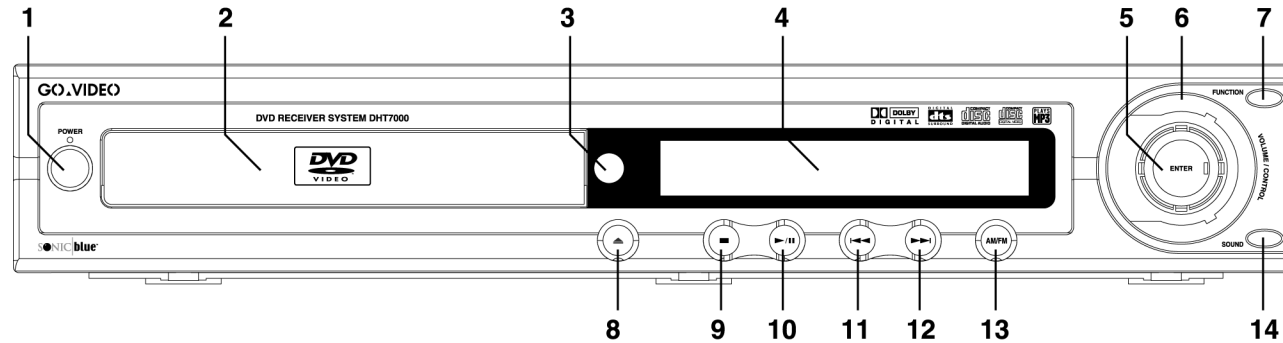

- 1 POWER** Press to switch between power on and Standby mode.
- 2 Disc Tray** Use for playback of DVDs, CDs, etc.
- 3 Sensor** Infrared remote control sensor.
- 4 Front Panel Display** Displays feedback on DVD System operation; see page 5.
- 5 ENTER & ARROW KEYS** ▲/▼/◀/▶ Use to navigate within on-screen menus without the remote control.
- 6 VOLUME/CONTROL** Rotate to adjust the volume.
- 7 FUNCTION** Press to switch control among the four main functions: DVD, Tuner, Video 1 and Video 2.
- 8 EJECT** Press to open and close the DVD deck, or to eject the tape from the VCR deck.
- 9 STOP** Press to stop playback.
- 10 PLAY/PAUSE** Press once to start playback. Press again to pause playback. Press again to resume playback.
- 11 SKIP BACKWARD** |◀◀/PRESET- In DVD mode, press to skip to the previous chapter or track. In Tuner mode, press to skip to the previous Preset.
- 12 SKIP FORWARD** ▶▶|/PRESET+ In DVD mode, press to skip to the next chapter or track. In Tuner mode, press to skip to the next Preset.
- 13 AM/FM** Press to set the Tuner band to AM or FM.
- 14 SOUND** Press to select among various preset EQ settings, such as FLAT, POP, ROCK, JAZZ or CLASSIC.

Front Panel Display

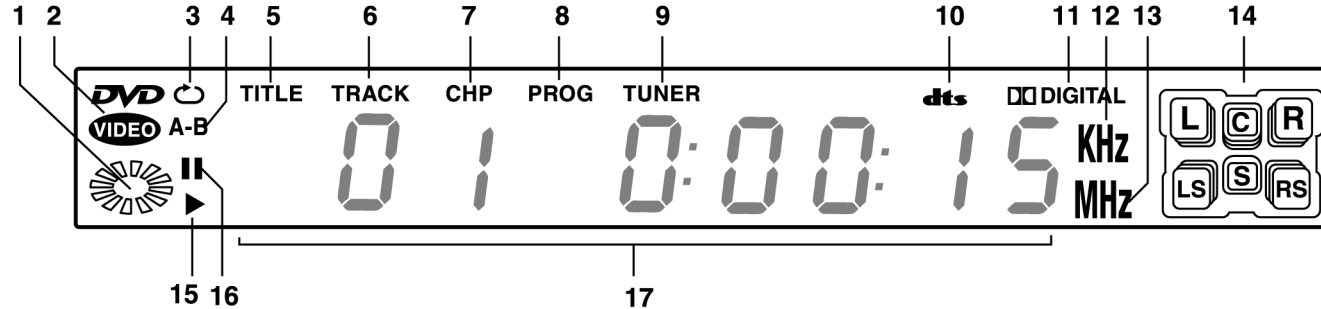

- 1 DVD Status Indicator** Rotates during DVD playback.
- 2 DVD Video Indicator** Lights if DVD disc is loaded (dims if CD or VCD is loaded).
- 3 Repeat Status Indicator** Lights if disc is in repeat mode.
- 4 AB Repeat Indicator** Lights if disc is in AB repeat mode.
- 5 Title Number Indicator** Shows current title number.
- 6 Track Number Indicator** Shows current track number.
- 7 Chapter Number Indicator** Shows current chapter number.
- 8 Program Indicator** Lights if disc is in program playback mode.
- 9 Tuner Indicator** Lights if tuner function is active.
- 10 DTS Indicator** Lights if DVD with DTS soundtrack is loaded.
- 11 Dolby Digital Indicator** Lights if DVD with Dolby Digital soundtrack is loaded.
- 12 KHz Indicator** Lights if tuner function is in AM mode.
- 13 MHz Indicator** Lights if tuner function is in FM mode.
- 14 Speaker Status Indicator** Shows currently active speakers.
- 15 Playback Status Indicator** Lights if disc is playing.
- 16 Pause Indicator** Lights if disc is in pause mode.
- 17 Elapsed Time Indicator** Shows current playback time in hours, minutes and seconds. Also shows the current station frequency in the tuner function.

Rear Panel

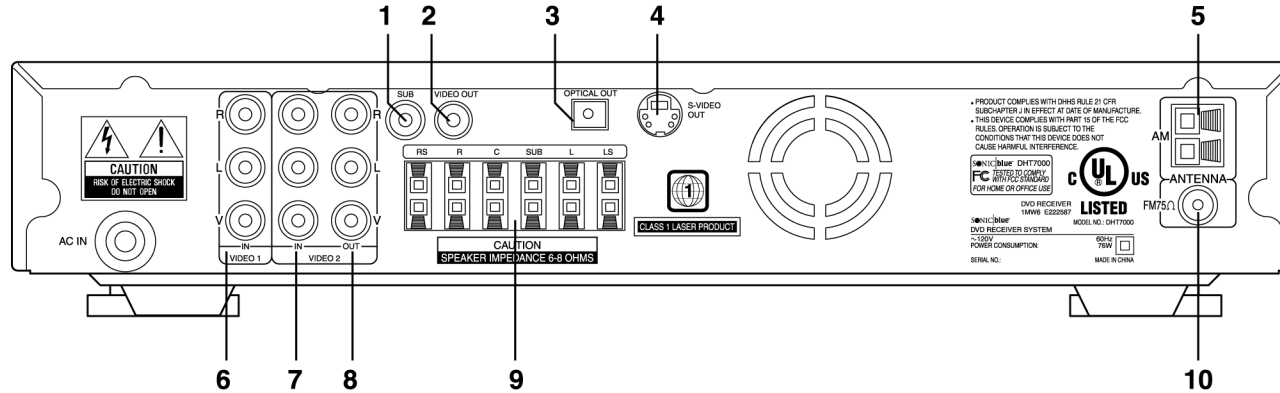

- 1 Subwoofer Output** Analog Low Frequency Effect (LFE) Output
- 2 Video Out** Composite Video Output
- 3 Optical Output** Optical Digital Audio Output
- 4 S-Video Output** S-Video Output
- 5 AM Antenna Input** AM Antenna Block Terminals
- 6 Video 1 Input** Composite Video/Stereo Audio Input
- 7 Video 2 Input** Composite Video/Stereo Audio Input
- 8 Video 2 Output** Composite Video/Stereo Audio Output
- 9 Speaker Outputs (RS, R, C, SUB, L, LS)** 5.1 Channel Speaker Outputs (Right Surround, Right, Center, Subwoofer, Left, Left Surround)
- 10 FM75Ω Antenna Input** FM Antenna Coaxial Socket



- Please continue with Chapter 2 to connect your DVD system.

:: Connecting the System

Follow these seven steps to connect the DVD system. It is recommended that you turn off power on all components (or unplug AC power) while you are connecting the system.

Step 1 - Connect TV

Composite Video Connect the supplied video cable from the Video Out jack on the back panel of the DVD system to your television's Video In jack.

S-Video For better video quality, you can connect the system to your TV with an S-Video cable (not included). Connect the S-Video cable from the S-Video Out jack on the back panel of the system to your television's S-Video In jack.

Step 2 - Place Speakers

For best results, arrange the six speakers as shown in your listening area:

Front Speakers (L, R) Set the front speakers so they are aligned at ear level and at a horizontal angle of 45 degrees to the primary listening area.

Center Speaker (C) The center speaker should be positioned with its top surface flush with the front speakers. However, you may place the speaker either on top of or next to your TV set.

Rear Speakers (LS, RS) Set the surround speakers further back, parallel to the walls, at 2 to 3 feet above the ear level of the primary listening area. If the space behind the listening area is limited (i.e., close to the wall), place the rear speakers facing each other on either side.

Subwoofer (SUB) Place the subwoofer at any convenient location within the vicinity of the listening area.

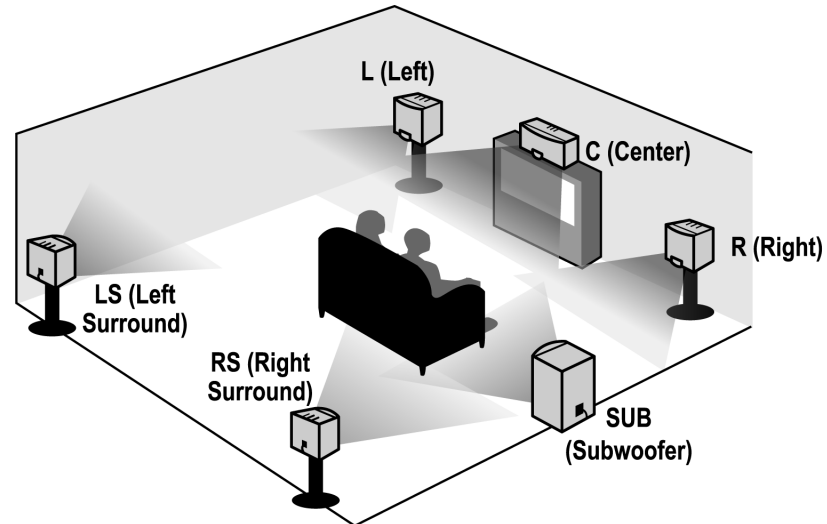

Step 3 - Connect Speakers

- 1 Make sure the power is turned off to prevent possible damage to the system.
- 2 Connect each pair of speaker wires to the red and black connectors on the back of each speaker, and to the matching connectors on the back panel of the DVD system. *Be sure to connect all the marked wires to the negative (black) terminals!*
- 3 To insert a speaker wire, press down on the red or black thumb lever, insert the tip of the wire, and then release the thumb lever to lock the wire in place.



- **CAUTION** - Short circuiting the speakers may damage the system. To prevent this, make sure the exposed tip of each speaker wire does not touch another speaker wire or another speaker terminal.
- Do not connect speakers or any other devices that are not included with this system.
- To obtain the best possible surround sound, output a test tone and balance the speakers; see page 19.

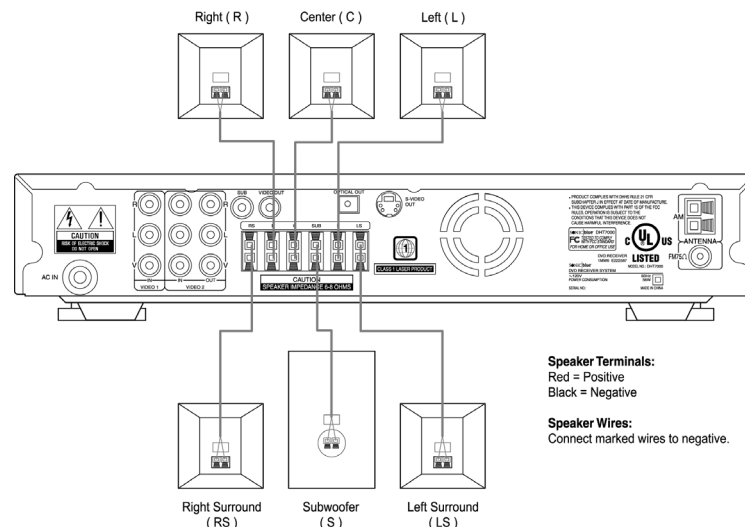

Speaker Terminals:
Red = Positive
Black = Negative

Speaker Wires:
Connect marked wires to negative.

Step 4 - Connect AM Loop Antenna

- 1 Assemble the supplied AM loop antenna by rotating the base and snapping it into place.
- 2 Connect the two wires from the AM loop antenna to the AM Antenna connector on the back panel. Press down on the thumb levers to insert each wire, and then release to lock the wires in place.



- To prevent noise pickup, keep the AM loop antenna away from the system and other components.

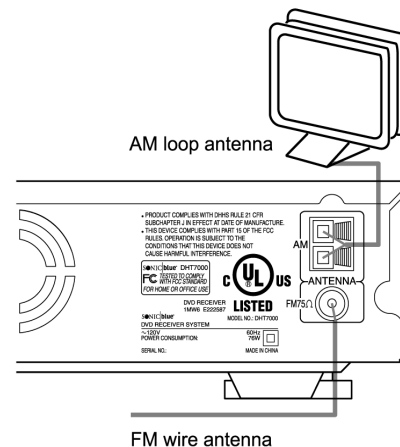

Step 5 - Connect FM Wire Antenna

- 1 Connect the supplied FM wire antenna to the FM 75Ω Antenna connector on the back panel.
- 2 Be sure to fully extend the FM wire antenna. Make use of the small loop at the free end of the antenna to maintain its position.
- 3 If noise or interference occurs, use an external antenna with a 75Ω coaxial cable (not included).



- After connecting the FM wire antenna, keep it as horizontal as possible. The antenna is directional, so you may need to move it around to get the best reception.

Step 6 - Connect External Audio/Video Components (Optional)

The back panel of the DVD System provides five additional inputs and outputs you can use to connect external audio/video components, such as a VCR, satellite receiver or powered subwoofer.

Video 1 Input Connect from the outputs of a VCR (or other audio/video component) with coaxial cables. This input enables you to enjoy Pro Logic surround sound from videotapes playing in your VCR.

Video 2 Input Connect from a satellite receiver or cable box with coaxial cables. This input enables you to enjoy surround sound from television broadcasts.

Video 2 Output Connect to the inputs of your TV, VCR (or other audio/video component) with coaxial cables. Be sure to set the correct output format of the audio signal for your component; see “Audio Setup” on page 14.

Sub Output Connect to a powered subwoofer (not included) with a coaxial cable.

Optical Output Connect to a digital recorder, such as a MiniDisc recorder, with an optical cable. Be sure to set the correct output format of the audio signal for your component; see “Audio Setup” on page 14.

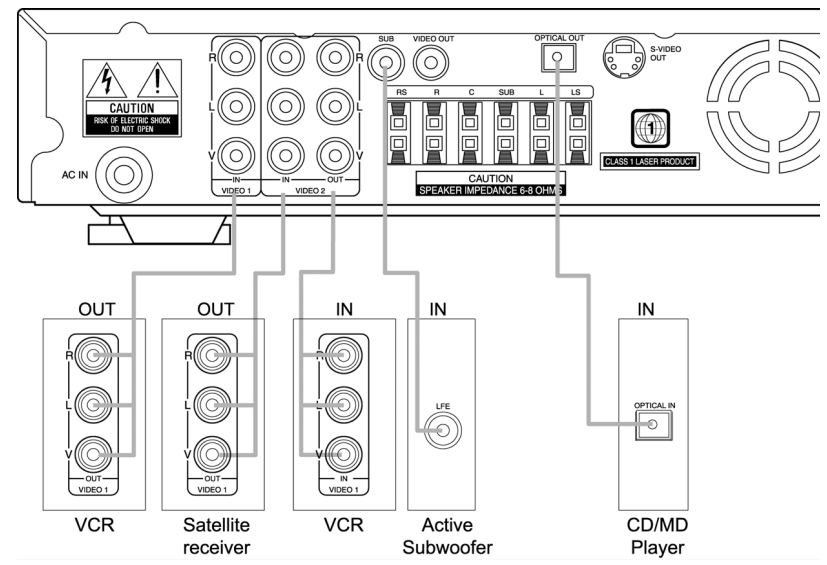

Step 7 - Power on the System

- 1 Connect the power cord to a standard 120VAC/60Hz electrical outlet.
- 2 The red Standby LED will glow on the front panel to indicate that the system is plugged in and in Standby mode.
- 3 Press the POWER button on the front panel or the remote control to power on the unit.

About Standby Mode

- The system is always in Standby mode when the AC power cord is plugged into an electrical outlet.
- In Standby mode, the front panel display on the main unit turns off and the red power indicator light turns on.
- In power on mode, the front panel display on the main unit turns on and the red power indicator light turns off.
- The only way to power on the main unit is to press the POWER button.



- *Please continue with Chapter 3 to adjust the operational settings for your DVD system.*

:: Setup Menu Overview

Setup Menu Categories

After the system is properly connected, it is important to customize the factory preset values for your particular components and preferences. There are five major categories in the Setup menu:

- 1 For **Language** Setup; see page 12.
- 2 For **Video** Setup; see page 14.
- 3 For **Audio** Setup; see page 14.
- 4 For **More Audio** Setup; see page 17.
- 5 For **Rating** Setup; see page 18.



- For information on *Speaker Setup*; see page 19.
- For an overview of the entire menu system, please see the inside back cover of this User's Guide.

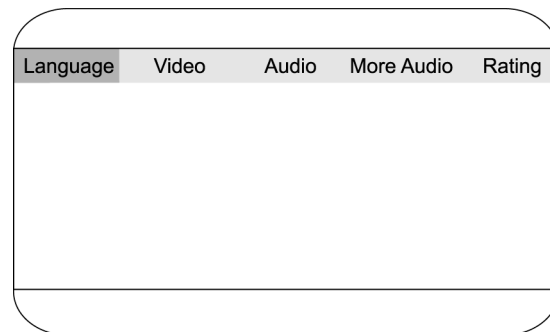

Setup Menu Navigation

The following keys are used to display and navigate within the Setup menu:

STOP Press to stop the DVD deck (required in order to view the Setup menu).

SETUP Press to display and exit the Setup menu.

◀▶ Press to move the cursor to highlight the desired category or submenu.

ENTER Press to view the submenus under each category. Also use to make selections and confirm menu settings.

▲ Press to move up the list of submenus. Also use to return to the previous menu.

▼ Press to move down the list of submenus.

RETURN Press to save the current settings and exit the Setup menu.



- The DVD player *must* be in Stop mode to view the Setup menu.
- You can also navigate the Setup menu using the ENTER button and arrow keys on the front panel.

:: Language Setup

The Language category allows you to set your language preferences for On-Screen Display (OSD) Menus, Subtitles, Audio soundtracks and DVD Disc Menus.

OSD Menu Language

To select your preferred language for the DVD system setup menu and on-screen displays:

- 1 Press SETUP.
- 2 Select Language and press ENTER.
- 3 Select OSD Menu and press ENTER.
- 4 Set the desired OSD Menu Language to English (default), French or Spanish and press ENTER.
- 5 Press SETUP to save and exit.

Language	Video	Audio	More Audio	Rating
OSD Menu		English	English	
Subtitle		English	French	
Audio		English	Spanish	
Disc Menu		English		

Subtitle Language

To select your preferred language for DVD subtitles:

- 1 Press SETUP.
- 2 Select Language and press ENTER.
- 3 Select Subtitle and press ENTER.
- 4 Set the desired Subtitle Language to English (default), French or Spanish and press ENTER.
- 5 Press SETUP to save and exit.

Language	Video	Audio	More Audio	Rating
OSD Menu		English		
Subtitle		English	English	
Audio		English	French	
Disc Menu		English	Spanish	
			Auto	
			Off	



- *Select AUTO to always select the disc's default Subtitle Language.*
- *Select OFF to always turn Subtitles off.*
- *Subtitles vary from disc to disc. The disc itself may override your selection.*

Audio Language

To select your preferred language for DVD audio soundtracks:

- 1 Press SETUP.
- 2 Select Language and press ENTER.
- 3 Select Audio and press ENTER.
- 4 Set the desired Audio Language to English (default), French or Spanish and press ENTER.
- 5 Press SETUP to save and exit.



- Languages vary from disc to disc. The disc itself may override your selection.

Language	Video	Audio	More Audio	Rating
OSD Menu		English		
Subtitle		English		
Audio		English	English	
Disc Menu		English	French	Spanish

Disc Menu Language

To select your preferred language for DVD disc menus:

- 1 Press SETUP.
- 2 Select Language and press ENTER.
- 3 Select Disc Menu and press ENTER.
- 4 Set the desired Disc Menu Language to English (default), French or Spanish and press ENTER.
- 5 Press SETUP to save and exit.



- Languages vary from disc to disc. The disc itself may override your selection.

Language	Video	Audio	More Audio	Rating
OSD Menu		English		
Subtitle		English		
Audio		English		
Disc Menu		English	English	French
				Spanish

:: Video Setup

The Video category allows you to set the size of your television, and your preferred format for widescreen movies (DVD only).

TV Aspect

TV Aspect adjusts the aspect ratio of your television (the length divided by the width of the screen). Standard television screens are 4:3, while widescreen televisions are 16:9. To set your TV Aspect:

- 1 From Stop mode, press SETUP.
- 2 Select Video and press ENTER.
- 3 Select TV Aspect and press ENTER.
- 4 Select the desired TV Aspect and press ENTER:
 - Fullscreen** (default) Select if you have a standard 4:3 television and prefer to watch the full-screen versions of DVD movies (if available).
 - Letterbox** Select if you have a standard 4:3 television and prefer to watch the widescreen versions of DVD movies (if available). Movies will display in letterbox format; i.e., black bars will appear above and below the picture.
 - Widescreen** Select if you have a widescreen 16:9 television.
- 5 Press SETUP to save and exit.

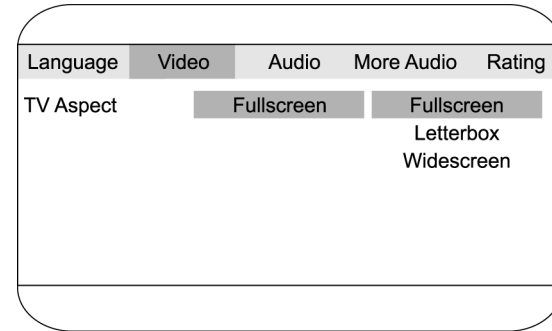

:: Audio Setup

Audio Setup allows you to match the output signals of the DHT7000 to an external recording device, processor/amplifier or receiver connected via the Video 2 Out (analog) or Optical Out (digital) jacks. For example, if you connect the system to a VCR from the Video 2 Out jacks, you should set Dolby Digital and DTS to 2 channel for downmixed stereo audio.



- You can set the audio format for each of the following sources: *Dolby Digital, DTS, MP3 and CD/VCD.*
- *DVD playback must be stopped in order to adjust the Audio Setup.*

Dolby Digital Setting

Follow these steps to set the analog and digital format of outgoing Dolby Digital 5.1 soundtracks:

- 1 Press SETUP.
- 2 Select Audio and press ENTER.
- 3 Select Dolby D and press ENTER.
- 4 Set Analog Out (from Video 2 Out) to:
 - 6 Channel** (default) To output only the front left and front right signals of the 5.1 soundtrack.
 - 2 Channel** To output downmixed 2 channel stereo; e.g. to a VCR or TV.
- 5 Set Digital Out (from Optical Out) to:
 - PCM** (default) To output 2 channel digital audio; e.g. to a Minidisc recorder.
 - Bitstream** To output the 5.1 channel digital bitstream to an external amplifier with a Dolby Digital decoder.
 - Off** To disable Dolby Digital output.
- 6 Press SETUP to save and exit.

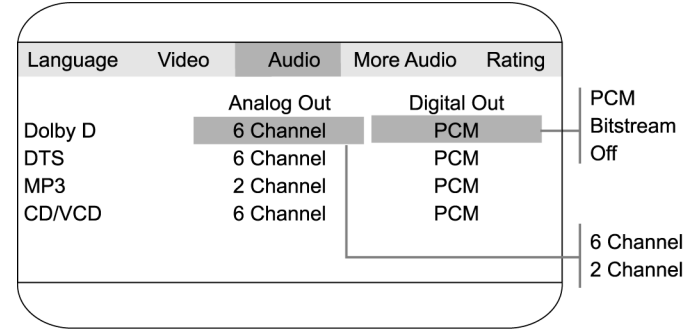

• *PCM stands for Pulse Code Modulation, and is the standard 2-channel stereo format used for audio CDs.*

DTS Setting

Follow these steps to set the analog and digital format of outgoing DTS soundtracks:

- 1 Press SETUP.
- 2 Select Audio and press ENTER.
- 3 Select DTS and press ENTER.
- 4 Set Analog Out (from Video 2 Out) to:
 - 6 Channel** (default) To output only the front left and front right signals of the DTS soundtrack.
 - 2 Channel** To output downmixed 2 channel stereo; e.g. to a VCR or TV

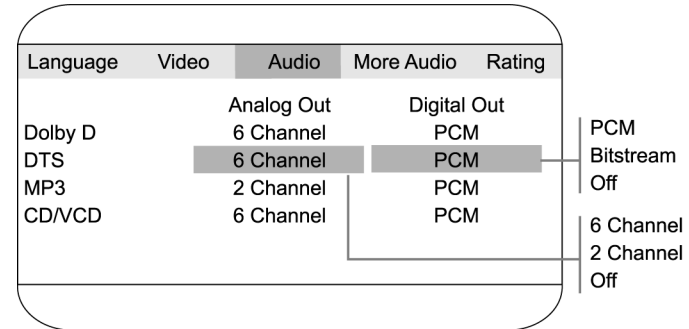

- Off** To disable DTS analog output.
- 5 Set Digital Out (from Optical Out) to:
 - PCM** (default) To output 2 channel digital audio; e.g. to a Minidisc recorder.
 - Bitstream** To output the DTS digital bitstream to an external amplifier with a DTS decoder.
 - Off** To disable DTS digital output.
- 6 Press SETUP to save and exit

MP3 Setting

Follow these steps to set the outgoing digital format of MP3 audio tracks (Note: The analog format is fixed to 2 channel):

- 1 Press SETUP.
- 2 Select Audio and press ENTER.
- 3 Select MP3 and press ENTER.
- 4 Set Digital Out (from Optical Out) to:
 - PCM** (default) To output 2 channel digital audio; e.g. to a Minidisc recorder.
 - Off** To disable MP3 digital output.
- 5 Press SETUP to save and exit

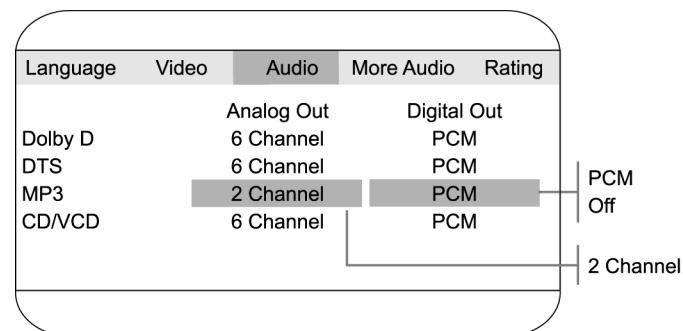

CD/VCD Setting

Follow these steps to set the outgoing analog and digital format of CD and VCD audio tracks:

- 1 Press SETUP.
- 2 Select Audio and press ENTER.
- 3 Select Others and press ENTER.
- 4 Set Analog Out (from Video 2 Out) to:
 - 2 Channel** (default) To output 2 channel stereo. Enables use of the L/R button during VCD playback; see page 30.
 - 6 Channel** To enjoy Pro Logic surround sound from CDs and VCDs. Make sure Pro Logic is enabled; see page 17.

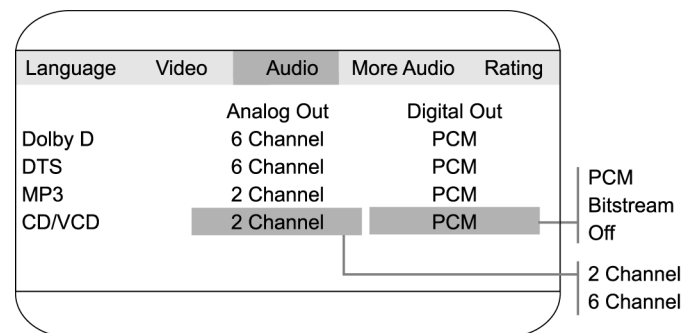

- 5 Set Digital Out (from Optical Out) to:
 - PCM** (default) To output 2 channel digital audio; e.g. to a Minidisc recorder.
 - Bitstream** To output the digital bitstream to an external amplifier.
 - Off** To disable CD/VCD audio output.
- 6 Press SETUP to save and exit.

:: More Audio Setup

The More Audio category allows you to enable Pro Logic, and set the size of front left and right speakers.

Pro Logic Setting

The DVD system has a built-in Dolby Pro Logic decoder to provide surround sound from an analog source (such as a VCR) connected to the Video In jacks.

- 1 Press SETUP.
- 2 Select More Audio and press ENTER.
- 3 Select Pro Logic and press ENTER.
- 4 Select the desired Pro Logic setting and press ENTER:
 - Auto** (default) The DVD system will automatically enable Dolby Pro Logic if a Pro Logic signal is detected.
 - On** Dolby Pro Logic decoding will always be active.
 - Off** Dolby Pro Logic decoding will always be inactive.
- 5 Press SETUP to save and exit.

Language	Video	Audio	More Audio	Rating
Pro Logic		Auto	Auto	
L/R Speaker		Large	On	
			Off	

L/R Speaker Setting

If you use different left and right front speakers than those supplied with the system, you can specify their size as Small or Large:

- 1 Press SETUP.
- 2 Select More Audio and press ENTER.
- 3 Select L/R Speaker and press ENTER.
- 4 Select the desired Left/Right Speaker size and press ENTER:
 - Small** (default) Indicates that you are using the supplied front speakers.
 - Large** Indicates you are connecting custom front speakers that are larger than the supplied speakers.
- 5 Press SETUP to save and exit.

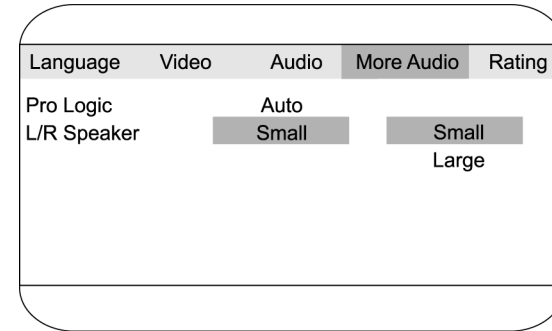

:: Rating Setup

The Rating category allows you to block playback of inappropriate content with a password-protected Rating system (not all discs are rated).

Setting the Password & Rating Level

- 1 Press SETUP.
- 2 Select Rating and press ENTER.
- 3 Select Rating and press ENTER repeatedly to set the rating from 1 (most restrictive) to 8 (least restrictive).
 - If a password has already been set, the lock icon will be closed. You will not be able to select Rating until you enter the correct password using the 0-9 keys.
- 4 Select Password.
- 5 Use the 0-9 keys to enter a 4-digit password and press ENTER. The lock icon will close to indicate that the rating and password are set.
- 6 Press SETUP to save and exit.

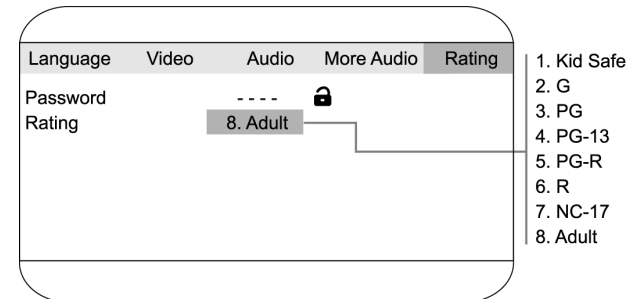



- *Not all DVDs are rated.*
- *DVDs that are rated higher than the level you select will not play without entering the correct password.*
- *If you forget your password, use 9999 to clear the memory. Keep this password out of reach of children as it will always unlock the Parental Control setting.*

:: Speaker Setup

Adjusting Speaker Balance/Levels

If your speakers are positioned at varying distances from your primary listening area, you can compensate by adjusting the relative volume levels for each speaker. The DHT7000 provides three ways to adjust levels:

Test Tone Generator Allows you to adjust levels by using a “white noise” reference signal that cycles through each speaker in a continuous loop.

Trim Level Allows you to fine-tune levels while a DVD disc is playing.

Volume Level Allows you to adjust the volume of all six speakers simultaneously.

Test Tone Generator

- 1 To use the Test Tone generator, a DVD disc must be loaded and the player must be in Stop mode.
 - See page 21 for information on loading discs.
- 2 Press TEST TONE on the remote control. A “white noise” test tone is automatically sent to each of the six speakers in a continuous loop.
 - The test tone is broadcast for approximately 5 seconds in the following order: Left, Center, Right, Right Surround, Left Surround, Subwoofer.
- 3 Press the VOLUME +/- buttons on the remote control to adjust the volume level for each speaker.
 - The selected channel is indicated on both the front panel display and your TV screen.
 - You can adjust the level from -6dB to +6dB in 1dB steps (the default is 0dB).
- 4 When finished, press the TEST TONE button to stop the test tone and save your settings.



- *The Test-Tone generator is not available when a DVD disc menu is on screen.*
- *You can also use the VOLUME/CONTROL dial on the front panel to adjust volume levels.*
- *If you do not hear the test tone from a particular speaker, or from an incorrect speaker, the speaker may be incorrectly wired; see page 8.*



Getting Started



Connections



Setup



Basic Operations



Advanced Features



Help

Trim Levels

Use the Trim feature to fine-tune speaker levels during DVD playback:

- 1 To use the Trim feature, a DVD disc must be loaded and playing.
 - See page 21 for information on inserting and playing discs.
- 2 Press the TRIM button on the remote control to cycle through the six speakers in the following order: Left, Center, Right, Left Surround, Right Surround and Subwoofer.
- 3 Press the VOLUME +/- buttons on the remote control to fine-tune the volume level for each speaker.
 - The selected channel is indicated on the front panel display.
 - You can adjust the level from -6dB to +6dB in 1dB steps.



Note

- *For best results, use the Test Tone Generator as your primary reference level, and only use the TRIM function to fine-tune the system.*
- *Both TEST TONE and TRIM functions share the same settings; i.e., whatever adjustments you make to one function will be reflected in the other.*



Volume Level

Press the VOLUME +/- buttons on the remote control or rotate the VOLUME/CONTROL dial on the front panel to adjust the volume for all six speakers simultaneously.



:: First Things First

The first step in using the DHT7000 is to select one of the four basic functions. Do this by pressing the FUNCTION button on the remote control or front panel repeatedly to select:



1 DVD Function

For watching movies on DVD or VCD or listening to music on CD or MP3-CD.

2 Tuner Function

For listening to the AM/FM receiver. Press the AM/FM button to switch between the AM and FM bands.

3 Video 1 Function

For listening to the audio signal from an external device (such as a VCR) connected to the rear VIDEO 1 IN jacks.

4 Video 2 Function

For listening to the audio signal from an external device (such as a cable box or satellite receiver) connected to the rear VIDEO 2 IN jacks.



- You can also press the FUNCTION button on the front panel to select DVD, AM/FM, Video 1 or Video 2.

:: Basic Disc Playback

Playing a DVD, CD or VCD

Follow these steps to play a DVD, CD or VCD disc:

- 1 Turn on the TV and make sure the TV's video input source is set to view the DVD system.
- 2 Press the POWER button on the remote control or front panel to wake up the DVD system from standby mode.
- 3 Press EJECT on the remote control or front panel to open the disc drawer.
- 4 Place the disc in the drawer with the label side facing up and playback side facing down. If the disc has two sides, place the disc with the desired side facing up.

- 5 Press EJECT again to close the disc drawer.
 - The system will begin playback of the disc automatically when the disc drawer closes. If the DVD has a disc menu, or more than one title, the disc menu may appear; see Disc Menu Navigation below.
- 6 Adjust the volume of the system with the VOLUME +/- buttons on the remote control, or by using the VOLUME/CONTROL dial on the front panel.



- *Do not push the disc tray when closing it. Always use the EJECT button to close the disc tray.*
- *If the disc is scratched, dirty, or not encoded for Region 1, you will receive an error message and the disc will not play.*
- *Always use the STOP button to stop playback of a disc before powering off the system. Do not power off the system while a disc is playing as this may cancel any changes to the menu settings.*

Disc Menu Navigation

DVD disc menus allow you to select chapters for playback, change the disc's default playback settings (such as Audio format and Subtitle language) and access any special features on the disc. Use the following keys to navigate DVD disc menus.



DISC MENU Press to bring up the disc menu for the currently loaded disc. Menu contents vary by disc.

◀▶/▲▼ Press to move the cursor left, right, up and down in the disc menu.

ENTER Press to make selections and confirm settings in the disc menu.

0-9 Press to make direct selections in some disc menus.

RETURN Press to display the previous menu or to exit the disc menu.

Additional Disc Playback Options

- To freeze playback, press PAUSE/STEP.
- To advance one frame at a time (DVD only), press PAUSE/STEP again.
- To resume normal playback, press PLAY.
- To skip to the next or previous chapter/track, press SKIP FORWARD ▶▶ or SKIP BACKWARD |◀◀.
- To scan forward or backward at variable speeds during playback, press SCAN FORWARD ▶ or SCAN BACKWARD ◀◀ repeatedly (for 2x/4x/8x/20x times normal playback).
- To play in slow motion at variable speeds, press SLOW repeatedly (for 1/2, 1/4, 1/6, 1/7 times normal playback).

- To stop playback, press STOP once. The message “Stop (Play to resume)” appears on the TV screen. To resume playback from the same place on the disc, press PLAY.
- To stop playback completely and restart the disc, press STOP twice. To restart the disc, press PLAY.
- To mute audio output, press MUTE. Press again to restore audio output.

:: Basic Tuner Operation

Presetting Radio Stations

You can preset up to 15 FM stations and 15 AM stations. To preset radio stations:

- 1 Before you begin, turn the volume down on the system to avoid sudden and excessive noise from the speakers.
- 2 Press the FUNCTION button to switch to the Tuner (AM/FM) function.
 - The last station received is tuned in and its band and frequency are displayed on the front panel display.
 - You can also press the AM/FM key as a shortcut to enter the Tuner function.
- 3 Press the AM/FM button to select the desired band.
- 4 Press and hold TUNING + or - until the frequency starts to change, then release.
- 5 Scanning stops when the system tunes in a station. “Tuned” appears on the front panel display.
- 6 Press MEMORY. “Mem To - -” appears on the front panel display.
- 7 Use the 0-9 keys to enter a number from 01 to 15.
- 8 Press ENTER to confirm the memory number. The station is stored.
- 9 Repeat steps 3 to 8 to preset up to 15 stations in each band.



- *To tune in a weak station, press the TUNING +/- buttons to tune in the station manually.*
- *To change a preset station, simply save over the previously memorized station.*
- *Press ST/MONO to set the Tuner audio to Stereo or Mono.*

Listening to the Radio

- 1 Press the FUNCTION button to switch to the Tuner (AM/FM) function.
 - The last station received is tuned in and its band and frequency are displayed on the front panel display.
 - You can also press the AM/FM key as a shortcut to enter the Tuner function.
- 2 To select a preset station, press the PRESET +/- buttons on the remote control to skip to the next or previous station.
- 3 To change tuner bands, press the AM/FM button to toggle between AM and FM.
- 4 To tune in non-preset stations, press the TUNING +/- buttons on the remote control:
 - To tune manually, press the TUNING +/- buttons repeatedly until the desired station is tuned in.
 - To tune automatically, press and hold the TUNING +/- buttons until “Tuned” appears on the front panel display.
- 5 To improve reception, relocate the supplied antennas.

Adjusting Stereo/Mono



If an FM station is noisy, press the ST/MONO button on the remote control so that Mono appears on the front panel display.

- This turns off stereo sound but may improve reception.
- To switch back to stereo, press ST/MONO again.
- Not all stations are broadcast in stereo. For those stations without stereo, pressing the ST/MONO button has no effect.

Adjusting Bass/Treble



While in the Tuner function, press BASS/TREB to toggle between bass and treble.

- Adjust Bass level from -6dB to +6dB.
- Adjust Treble level from -6dB to +6dB.

:: Special Playback Features

Display

Press DISPLAY to view current information about the disc in play.

- 1 Press DISPLAY once to view elapsed/remaining time.
- 2 Press DISPLAY twice for detailed disc information, including disc type, title number, chapter number, angle number, audio soundtrack and subtitle language.
- 3 Press DISPLAY three times to turn off the display.

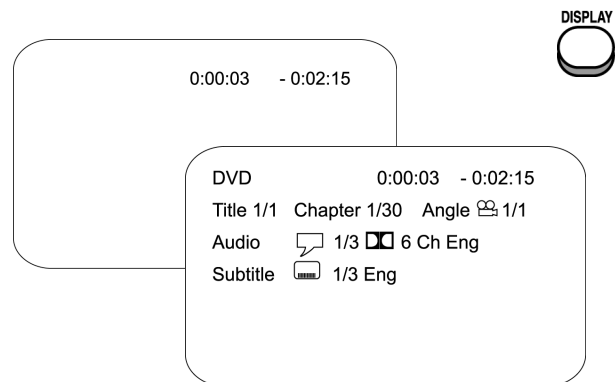

Go To

To jump to a specific Time, Title, Chapter or Track on your disc:

- 1 Press GO TO during DVD/CD playback.
- 2 Use the arrow keys to select Time, Title, Chapter or Track
- 3 Use the 0-9 keys to enter the desired Time (counter position), Title number or Chapter.
- 4 Press ENTER to jump to the desired Time, Title or Chapter/Track.

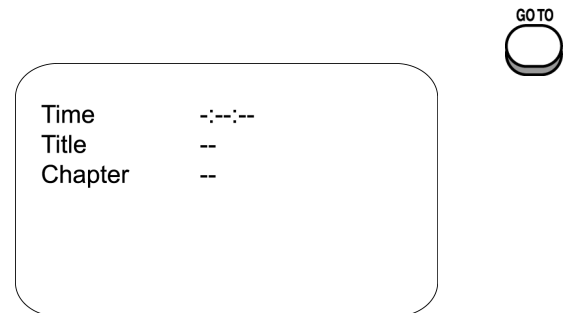

Title

When you play a DVD that contains several titles, you can select the title you want using the title menu.

- 1 Press the TITLE button on the remote control.
 - Contents of the title menu vary by disc.
- 2 Press the arrow keys or the 0-9 buttons to select a title for playback.
- 3 Press ENTER to start playback of the selected title.



Angle

Some DVDs contain scenes filmed from multiple angles. The Angle icon appears when additional angles are available. To select the angle you wish to view:

- 1 Press ANGLE when you see the Angle icon appear on screen during DVD playback.
- 2 Continue to press ANGLE to select among all available angles on the disc.



- *The Angle feature is not available during VCD playback.*

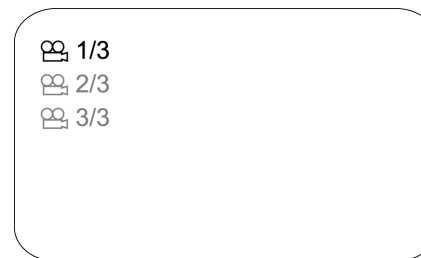

Zoom

To zoom in on the image during DVD playback:

- 1 Press ZOOM during DVD playback to display the magnifying glass.
- 2 Continue to press ZOOM to magnify the image at 3 levels of magnification.

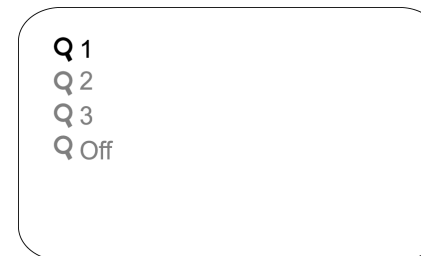

Subtitle

Many DVDs contain subtitles in multiple languages. To select among all available subtitle languages:

- 1 Press SUBTITLE during DVD playback.
- 2 Continue to press SUBTITLE to select among all available subtitle languages.

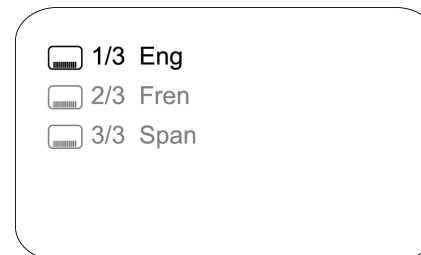

Audio

Many DVDs contain multiple audio formats, such as Dolby Digital 5.1 or 2-Channel Stereo, or soundtracks in multiple languages. To select among all available audio formats/soundtracks:

- 1 Press AUDIO during DVD playback.
- 2 Continue to press AUDIO to select among all available audio formats.

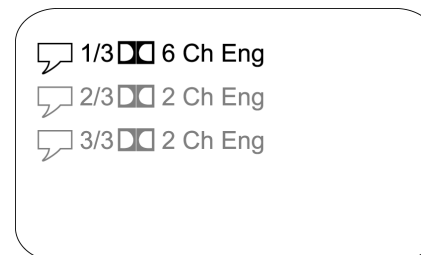

Getting Started



Connections



Setup



Basic Operations



Advanced Features



Help

Repeat

To repeat a Title, Chapter or Track:

- 1 Press REPEAT during disc playback.
- 2 Continue to press REPEAT to select Repeat Title, Repeat Chapter, or Off (DVD); or Repeat Single, Repeat All or Off (CD/VCD).
- 3 To quit Repeat Play, press REPEAT until Off appears on the screen.



Note

- *The SKIP FORWARD/BACK buttons cannot skip to the next/previous title/chapter/track if a title/chapter/track is in Repeat Play.*

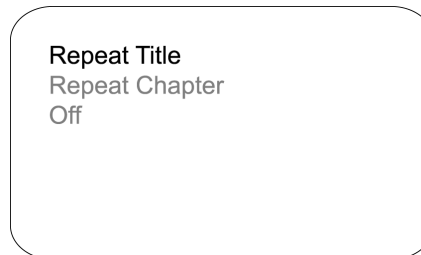

REPEAT

A-B Repeat

The A-B Repeat function allows you to repeat a segment of a DVD or CD. To program A-B Repeat:

- 1 Press A-B during DVD/CD playback to select point A.
- 2 Press A-B again to select point B.
- 3 The segment will begin repeating in a continuous loop.
- 4 To cancel, press A-B again. “Off” appears on the screen.



Note

- *The minimum A-B Repeat time is 5 seconds.*
- *The SKIP FORWARD/BACK buttons do not function during AB Repeat.*

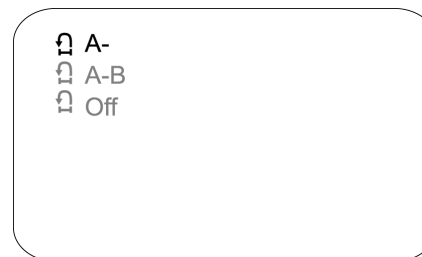

A-B

Program Playback

Program Playback lets you play DVD titles/chapters (or CD tracks) in a custom order. You can program up to 12 titles/chapters or tracks.



- 1 Press PROGRAM while a DVD/CD is in Stop mode.
 - The Program menu appears with the first title/chapter or track highlighted.
- 2 Use the arrow keys to move the cursor to one of the 12 empty placeholders.
- 3 Use the 0-9 keys to enter the number of the title/chapter or track you wish to add to your playlist.
 - If you enter an invalid number, it will be cleared and the cursor will remain in the same position.
 - To change an entry as you are typing, press CLEAR.
- 4 Repeat this process until all chapters/tracks are added in the desired order.
- 5 When finished, move the cursor to Play Program and press ENTER. The disc will play in the programmed order.
- 6 To cancel Programmed Play, press STOP and then press CLEAR.

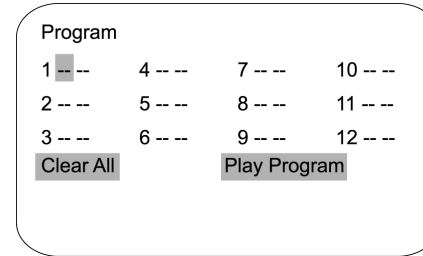

- To clear all entries, navigate to “Clear All” and press ENTER
- To exit the Program menu without saving your entries, press STOP.

Enhance Video Setting

Follow these steps to adjust Brightness and Edges (Sharpness) during playback:

- 1 During playback, press SETUP.
- 2 Select Brightness or Edges, and press ENTER to set as follows:
 - Brightness** Adjusts the overall brightness of the picture. Choose On or Off.
 - Edges** Adjusts sharpness of picture detail. Choose Sharpen, Soften or Off.
- 3 Press SETUP to save and exit.

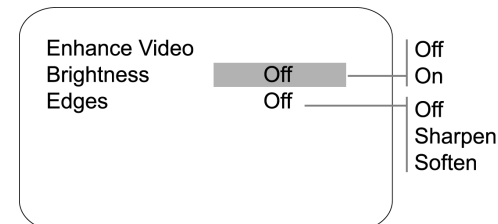

Getting Started



Connections



Setup



Basic Operations



Advanced Features



Help

:: VCD Playback

Playing VCDs

VCDs with PBC (Playback Control) allow you to navigate VCD disc menus and select individual tracks for playback.

- 1 Insert a VCD with PBC and press PLAY.
- 2 As playback starts, the PBC menu appears on the screen.
 - VCD 1.1 does not support PBC functions.
- 3 Use the arrow keys or the 0-9 key to select the desired track number.
- 4 Press ENTER to confirm your selection.
- 5 Follow the instructions in the PBC menu or supplied with the disc for special interactive features.
 - Features vary from disc to disc.
- 6 To return to the PBC menu during playback, press the RETURN button.



- *The PBC function can be switched off by pressing the DISC MENU button on the remote control. This button toggles PBC on and off during VCD playback.*
- *If the PBC status is changed from off to on, playback might restart from the beginning of the VCD disc.*
- *When the PBC function is switched off, the RETURN button will not work. Depending on the structure of the VCD, the SKIP FORWARD/BACKWARD buttons may not work either.*

Sound

The SOUND button on the remote control offers five preset EQ settings for use during VCD or CD audio playback.

- 1 Press SOUND to view the current EQ setting during VCD or CD audio playback:
- 2 Continue to press SOUND to change the EQ to FLAT, POP, ROCK, JAZZ or CLASSIC.



L/R Button

The L/R (Left channel/Right channel) button on the remote control allows you to manually set the Audio Output of VCD/CDDA discs.

- 1 Before you begin, CD/VCD must be set to 2 Channel in the Setup/Audio menu; see page 16.
- 2 Press L/R to view the current L/R audio setting.



- 3 Press L/R repeatedly to set the VCD/CD audio output to STEREO, LEFT, RIGHT or MIX (mix of left and right channels coming out of both speakers).



- For example, when playing a disc containing a song with the vocals on the right channel and the instruments on the left channel, select LEFT to hear just the instruments from both speakers.

:: MP3 Playback

MP3 is a popular music format which allows you to compress music files up to 1/12 of their original size while retaining near CD quality sound. Your DVD-VCR can playback MP3 files burned onto a CD-R or CD-RW disc.

- 1 Insert a CD-R/CD-RW disc with MP3 files into the DVD disc tray.
 - After a brief delay, the MP3 main menu will appear and the first song on the disc will begin playing.
 - Depending on the number of tracks/directories on the disc, it may take 30 seconds or more for the unit to read the disc.
- 2 Press DISC MENU to view a list of the contents of the disc.
 - If the disc has multiple directories, only the contents of the first directory will be displayed.
 - To select a different directory, highlight the name of the current directory and press ENTER. Repeat this process to browse all directories on the disc.
- 3 To play a track, use the arrow keys to navigate to the desired track and press ENTER to select. File names are abbreviated to seven characters.
- 4 To skip to the next or previous track, press SKIP FORWARD/BACK.
- 5 To stop playback, press STOP.

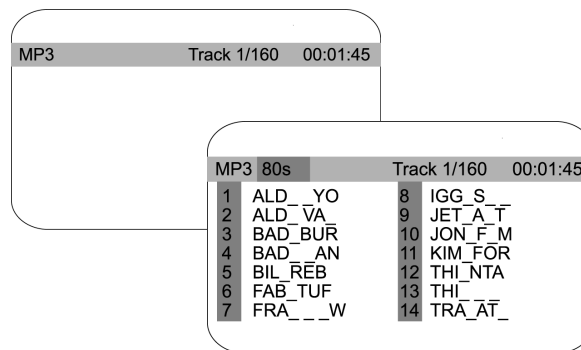



- *To ensure proper playback of discs burned from MP3 files, make sure the files have been recorded at a bit rate of at least 128 kbps.*
- *If there are any gaps (blank data) on multi-session discs, you may experience playback problems.*
- *Additional features available during MP3 playback are: SOUND, REPEAT and BASS/TREB.*

:: Troubleshooting

Customer Service Information

The FAQs below will help you solve common issues with your DVD System. If you don't find the answers you need here, you can contact our Customer Service Department as follows:

Phone (480) 922-0896 or (800) 736-7679

E-Mail customersupport@sonicblue.com

Web www.govideo.com or www.sonicblue.com

Frequently Asked Questions

Problem	Solution
No power.	<ul style="list-style-type: none">• Make sure the AC power cord is securely connected.
No picture.	<ul style="list-style-type: none">• Securely connect video cable.• Repair or replace damaged video cable.• Make sure the system is connected to the correct TV input.• Make sure the video input on the TV is set to view the DVD system.
Picture noise.	<ul style="list-style-type: none">• Make sure the disc is not dirty or flawed.• If the picture output from your system goes through your VCR to get to your TV, the copy-protection signal applied to some DVD programs could affect picture quality. If you still experience problems even when you connect your system directly to your TV, try connecting your system to your TV's S-Video input.
DVD picture does not fill screen on standard television.	<ul style="list-style-type: none">• The aspect ratio of the disc is fixed on your DVD.
Left/right sounds unbalanced or reversed.	<ul style="list-style-type: none">• Make sure speakers and components are correctly and securely connected.• Adjust balance of speaker levels.



Getting Started



Connections



Setup



Basic Operations



Advanced Features



Help

No sound.	<ul style="list-style-type: none"> • Securely connect all audio cables. • Repair or replace any damaged audio or speaker cables. • Press MUTE button on remote control if mute icon is displayed on the TV screen. • The system is in Pause, Slow Motion, Forward/Reverse Scan. Press PLAY on the remote control to return to normal playback mode. • Check speaker levels.
Severe hum or noise.	<ul style="list-style-type: none"> • Make sure speakers and components are correctly and securely connected. • Make sure connecting cables are away from a transformer or motor, and at least 10 feet away from a TV or fluorescent light. • Move your TV away from your audio components. • The plugs and jacks are dirty. Wipe them with a cloth slightly moistened with alcohol. • Clean the disc.
No stereo sound during VCD/CD playback.	<ul style="list-style-type: none"> • Refer to VCD/CD audio setup on page 16 and page 30. • Check speaker connections and settings.
No surround effect during playback of Dolby Digital soundtrack.	<ul style="list-style-type: none"> • Refer to DVD audio setup on page 15 and page 27. • Check speaker connections and settings. • Depending on the DVD, the output signal may not use all 5.1 channels, but rather output monaural or stereo sound, even if the soundtrack is recorded in Dolby Digital format.
Cannot tune in radio stations.	<ul style="list-style-type: none"> • Make sure antennas are securely connected. Adjust the antennas and connect an external antenna if necessary. • The signal strength of the stations is too weak (when tuning in with automatic tuning). Use manual tuning. • No stations have been preset or the preset stations have been cleared. Preset the stations.
Remote does not function.	<ul style="list-style-type: none"> • Remove any obstacles between the remote and the system. • Move closer to the system when operating the remote. • Point the remote directly at the sensor on front panel of the system. • Replace the batteries.
Disc does not play.	<ul style="list-style-type: none"> • Make sure there is a disc in the tray. • Turn the disc over. Make sure the playback side is facing down on the disc tray. • The disc is skewed or warped. • The region code on the DVD does not match the system. • Moisture has condensed inside the system. Remove the disc and leave the system turned on for about half an hour.
Disc does not start playing from the beginning.	<ul style="list-style-type: none"> • Program Play or Repeat Play is selected. Press CLEAR to cancel these functions before playing a disc. • Resume Play is active. Press STOP twice and then restart DVD playback.

Disc plays automatically.	<ul style="list-style-type: none"> The DVD features an auto playback function.
Playback stops automatically.	<ul style="list-style-type: none"> Some discs contain an auto pause signal. While playing such a disc, the system stops playback at the auto pause signal.
Cannot perform certain functions, such as Stop, Search, Slow Motion Play, Repeat Play, or Program Play.	<ul style="list-style-type: none"> Depending on the disc, some operations may not be available. See the documentation that came with the disc.

:: Technical Specifications

Amplifier Section

Stereo Mode 40W + 40W (6Ω at 1 kHz, THD 10%)

Surround Mode Front: 40W + 40W; Center: 40W; Rear: 40W + 40W (6Ω at 1kHz, THD 10%); Subwoofer: 66W; Note: Depending on the sound field settings and the source, there may be no sound output from Center, Rear or Subwoofer channels.

Inputs (Analog) VIDEO 1,2 - Sensitivity: 200mV; Impedance: 50 kΩ

Outputs (Analog) VIDEO 2 (AUDIO OUT) - Voltage: 2V; Impedance: 1 kΩ

Outputs (Digital) OPTICAL OUT (CD) - Level: -18dBm

DVD System

Laser Semiconductor laser

Signal Format System NTSC

Frequency response at 2 CH STEREO mode - DVD (PCM): 20Hz to 20kHz (6 1.0dB); CD: 20Hz to 20kHz (6 0.5dB)

Signal-to-noise ratio More than 80dB (VIDEO 1 (AUDIO) connectors only)

Harmonic distortion Less than 0.1%

FM Tuner Section

System PLL quartz-locked digital synthesizer system

Tuning range 87.5 – 108.0MHz (100kHz step)

Antenna FM wire antenna

Antenna terminals 75Ω, unbalanced

Intermediate frequency 10.7MHz



Getting Started



Connections



Setup



Basic Operations



Advanced Features



Help

AM Tuner Section

System Tuner section: PLL quartz-locked digital synthesizer system

Tuning range 530-1,710kHz (with the interval set at 10kHz); 531-1,710kHz (with the interval set at 9kHz)

Antenna Loop antenna

Video Section

Video Input 1 Vp-p 75Ω

Video Output 1 Vp-p 75Ω

S-Video Output Y: 1 Vp-p 75Ω; C: 0.286 Vp-p 75Ω

Front Speakers

Speaker Unit 75 mm dia. cone type

Rated Impedance 6Ω

Dimensions (approx.) 3.5" x 4.7" x 5" (90 x 120 x 130 mm) (w/h/d)

Mass (approx.) 1.3 lbs (0.6kg)

Center/Rear Speakers

Speaker Unit 75 mm dia. cone type

Rated Impedance 6Ω

Dimensions (approx.) 3.5" x 4.7" x 5" (90 x 120 x 130 mm) (w/h/d)

Mass (approx.) 1.3 lbs (0.6kg)

Subwoofer

Speaker System Bass reflex

Speaker Unit 200 mm dia. cone type

Rated Impedance 6Ω

Dimensions (approx.) 9.5" x 13" x 15" (240 x 337 x 380 mm) (w/h/d)

Mass (approx.) 12.4 lbs (5.6kg)

General

Power Requirements North American model: 120 V AC, 60Hz

Power Consumption 76 W (120 V AC)

Dimensions (approx.) 13.4" x 2.6" x 10.6" (340 x 67 x 270 mm) (w/h/d) incl. projecting parts

Mass (approx.) 9.4 lbs (4.3 kg)

Operating Temperature 41 to 95F (5 to 35C)

Operating Humidity 5-90%

:: Warranty

Who Provides the Limited Warranty

During the warranty period, the Go-Video Warranty Administrator will honor DVD System service for 90 days labor, 1 year parts from the original date of consumer purchase. See below for Commercial, Industrial or Educational use coverage. The DVD System remote control is warranted for 90 days from the date of purchase.

Who is Protected

This warranty protects the original consumer owner of this Go-Video product.

What is Covered and How Long

This warranty covers internal operating parts and service/labor to repair or replace covered parts in this Go-Video product for 90 days labor, 1 year parts, from the date of purchase, defined as follows: (1) Original Consumer Retail Purchase; (2) First Rental Purchase Agreement; or (3) First Lease Purchase Agreement (the Warranty Period). Labor and replacement parts supplied during the Warranty Period are covered only for the remaining portion of the original Warranty Period. The Go-Video Warranty Administrator shall have no liability for service under this warranty if non-OEM (Original Equipment Manufacturer) replacement parts are used in the repair of your Go-Video product.

What the Owner Must Do If Service is Required

If service under this warranty is required, contact the Go-Video Warranty Administrator at (480) 922-0896 to determine the nearest authorized Go-Video service center.

What are the Exceptions

This warranty does not cover: (1) Normal maintenance service, such as video head cleaning. (2) Damage from misuse, abuse neglect or accident, natural disasters or Acts of God. (3) Cabinetry, decorative parts, A/C adapters, knobs or buttons. (4) The foreign country use of this product. (5) Go-Video product which has been electronically or mechanically modified in any way or incorporated into other products. (6) Installation and setup service adjustments. (7) Owner instruction. Your Owner's Guide provides information regarding operating instructions and user controls. For additional information, contact your authorized Go-Video dealer.

- Go-Video is not responsible for any shipping, handling or insurance charges.
- This Exclusive Limited Warranty excludes all incidental and consequential damages. Some states do not allow the exclusion of incidental and consequential damages, so the above exclusion may not apply to you.
- ALL IMPLIED WARRANTIES, INCLUDING IMPLIED WARRANTIES OF MERCHANTABILITY AND FITNESS FOR A PARTICULAR PURPOSE ARE LIMITED IN DURATION TO THE DURATION OF THIS WARRANTY PERIOD. Some states do not allow limitations on how long an implied warranty lasts, so the above limitation may not apply to you.
- This Exclusive Limited Warranty gives you specific legal rights and you may also have other rights which vary from state to state.



Getting Started



Connections



Setup



Basic Operations



Advanced Features



Help

Go-Video Warranty Administrator

SONICblue Corp.

7835 East McClain Drive

Scottsdale, Arizona

85260-1732

(480) 922-0896

customerservice@sonicblue.com

:: Safety

Important Safety Instructions

- 1 Read Instructions** All the safety and operating instructions should be read before the product is operated.
- 2 Retain Instructions** The safety and operating instructions should be retained for future reference.
- 3 Heed Warnings** All warnings on the product and in the operating instructions should be adhered to.
- 4 Follow Instructions** All operating and use instructions should be followed.
- 5 Cleaning** Unplug this product from the wall outlet before cleaning. Do not use liquid cleaners or aerosol cleaners. Use a damp cloth for cleaning.
- 6 Attachments** Do not use attachments not recommended by the product manufacturer as they may cause hazards.
- 7 Water and Moisture** Do not use this product near water – for example, near a bathtub, wash bowl, kitchen sink, or laundry tub; in a wet basement; or near a swimming pool; and the like.
- 8 Accessories** Do not place this product on an unstable cart, stand, tripod, bracket, or table. The product may fall, causing serious injury to a child or adult, and serious damage to the product. Use only with a cart, stand, tripod, bracket, or table recommended by the manufacturer, or sold with the product. Any mounting of the product should follow the manufacturer's instructions, and should use a mounting accessory recommended by the manufacturer.
A product and cart combination should be moved with care. Quick stops, excessive force, and uneven surfaces may cause the product and cart combination to overturn.
- 9 Ventilation** Slots and openings in the cabinet are provided for ventilation and to ensure reliable operation of the product and to protect it from overheating, and these openings must not be blocked or covered. The openings should never be blocked by placing the product on a bed, sofa, rug, or other similar surface. This product should not be placed in a built-in installation such as a bookcase or rack unless proper ventilation is provided or the manufacturer's instructions have been adhered to.



PORTABLE CART WARNING
(Symbol provided by RETAC)

- 10 Power Sources** This product should be operated only from the type of power source indicated on the marking label. If you are not sure of the type of power supply to your home, consult your product dealer or local power company. For products intended to operate from battery power, or other sources, refer to the operating instructions.
- 11 Grounding or Polarization** This product may be equipped with a polarized alternating-current line plug (a plug having one blade wider than the other). This plug will fit into the power outlet only one way. This is a safety feature. If you are unable to insert the plug fully into the outlet, try reversing the plug. If the plug should still fail to fit, contact your electrician to replace your obsolete outlet. Do not defeat the safety purpose of the polarized plug.
- 12 Power-Cord Protection** Power-supply cords should be routed so that they are not likely to be walked on or pinched by items placed upon or against them, paying particular attention to cords at plugs, convenience receptacles, and the point where they exit from the product.
- 13 Protective Attachment Plug** The product is equipped with an attachment plug having overload protection. This is a safety feature. See Instruction Manual for replacement or resetting of protective device. If replacement of the plug is required, be sure the service technician has used a replacement plug specified by the manufacturer that has the same overload protection as the original plug.
- 14 Outdoor Antenna Grounding** If an outside antenna or cable system is connected to the product, be sure the antenna or cable system is grounded so as to provide some protection against voltage surges and built-up static charges. Article 810 of the National Electrical Code, ANSI/NFPA 70, provides information with regard to proper grounding of the mast and supporting structure, grounding of the lead-in wire to an antenna discharge unit, size of grounding conductors, location of antenna-discharge unit, connection to grounding electrodes, and requirements for the grounding electrode. See figure 131.1.
- 15 Lightning** For added protection for this product during a lightning storm, or when it is left unattended and unused for long periods of time, unplug it from the wall outlet and disconnect the antenna or cable system. This will prevent damage to the product due to lightning and power lines surges.
- 16 Power Lines** An outside antenna system should not be located in the vicinity of overhead power lines or other electric light or power circuits, or where it can fall into such power lines or circuits. When installing an outside antenna system, extreme care should be taken to keep from touching such power lines or circuits as contact with them might be fatal.
- 17 Overloading** Do not overload wall outlets, extension cords, or integral convenience receptacles as this can result in a risk of fire or electric shock.
- 18 Object and Liquid Entry** Never push objects of any kind into this product through openings as they may touch dangerous voltage points or short-out parts that could result in a fire or electric shock. Never spill liquid of any kind on the product.
- 19 Servicing** Do not attempt to service this product yourself as opening or removing covers may expose you to dangerous voltage or other hazards. Refer all servicing to qualified service personnel.
- 20 Damage Requiring Service** Unplug this product from the wall outlet and refer servicing to qualified service personnel under the following conditions:

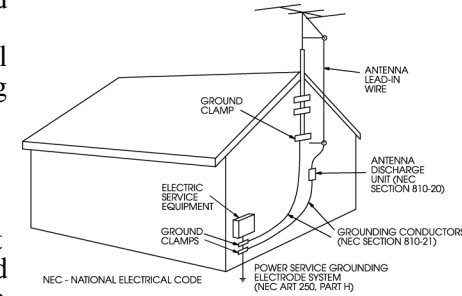

- When the power-supply cord or plug is damaged,
- If liquid has been spilled, or objects have fallen into the product,
- If the product has been exposed to rain or water,
- If the product does not operate normally by following the operating instructions. Adjust only those controls that are covered by the operating instructions as an improper adjustment of other controls may result in damage and will often require extensive work by a qualified technician to restore the product to its normal operation,
- If the product has been dropped or damaged in any way, and
- When the product exhibits a distinct change in performance – this indicates a need for service.

21 Replacement Parts When replacement parts are required, be sure the service technician has used replacement parts specified by the manufacturer or have the same characteristics as the original part. Unauthorized substitutions may result in fire, electric shock, or other hazards.

22 Safety Check Upon completion of any service or repairs to this product, ask the service technician to perform safety checks to determine that the product is in proper operating condition.

23 Wall or Ceiling Mounting The product should be mounted to a wall or ceiling only as recommended by the manufacturer.

24 Heat The product should be situated away from heat sources such as radiators, heat registers, stoves, or other products (including amplifiers) that produce heat.

Safety/Regulatory Information

Caution To prevent fire, shock hazard, or annoying interference, use only the recommended accessories.

To prevent electric shock, do not use this (polarized) plug with an extension cord, receptacle, or other outlet unless the blades can be fully inserted to prevent blade exposure.

To reduce the risk of electric shock, do not remove the unit cover or back. There are no serviceable parts inside.

Refer servicing to qualified personnel only.

WARNING: TO AVOID HAZARDOUS EXPOSURE TO INVISIBLE LASER RADIATION, DO NOT OPEN OR REMOVE/DEFEAT LASER TRANSPORT PROTECTIVE HOUSING.

CLASS 1 LASER PRODUCT This appliance is classified as a CLASS 1 LASER PRODUCT. The CLASS 1 LASER PRODUCT MARKING is located on the rear panel.

Note to CATV System Installer This reminder is provided to call the CATV system installer's attention to Article 820-40 of the National Electronic Code that provides guidelines for proper grounding and, in particular, specifies that the cable ground shall be connected to the grounding system of the building, as close to the point of cable entry as practical.

User/Installer Caution Your authority to operate this FCC certified equipment could be voided if you make changes or modifications not expressly approved by the manufacturer, who is responsible for compliance with Part 15 FCC rules.

This equipment has been tested and found to comply with the limits for a Class B digital device, pursuant to Part 15 of the FCC Rules. These limits are designed to provide reasonable protection against harmful interference in a residential installation. This equipment generates, uses, and can radiate radio frequency energy and, if not installed and used in accordance with the instructions, may cause harmful interference to radio communications. However, there is no guarantee that interference will not occur in a particular installation. If this equipment does cause harmful interference to radio or television reception, which can be determined by turning the equipment off and on, the user is encouraged to try to correct the interference by one or more of the following measures:

- Reorient or relocate the receiving antenna.
- Increase the separation between the equipment and receiver.
- Connect the equipment into an outlet on a circuit different from that to which the receiver is connected.
- Consult the dealer or an experienced radio/TV technician for help.

Cuidado Para prevenir incendio, riesgo de choque, o interferencia enfadosa, use solamente los accesorios recomendados. Para prevenir electrochoque, no use este enchufe (polarizado) con un cordón de extensión, toma de corriente, o cualquier otra toma a menos que los dientes puedan ser completamente insertados para prevenir exposición de los dientes. Para reducir el

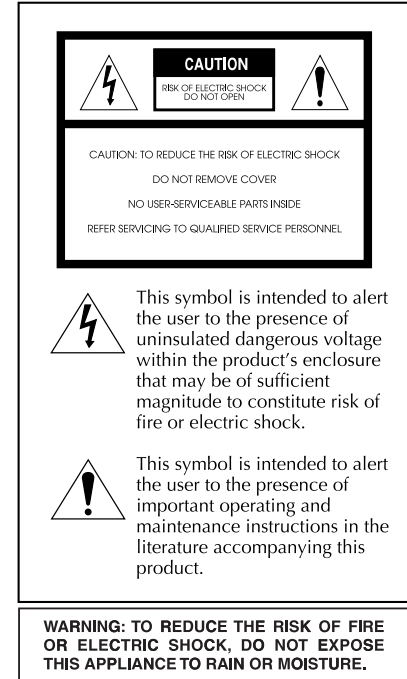

riesgo de descarga eléctrica, no remueva la cubierta o la parte posterior del DVD System. Dentro del DVD System no hay partes que requieren servicio. Dirijase solamente a personal calificado cuando requiera servicio.

Attention Pour éviter les incendis, risque de chocs, ou interférences fâcheuses, employer seulement les accessoires recommandés. Pour éviter les chocs électriques, ne pas employer cette prise (polarisée) avec une rallonge, une prise de courant ou une autre sortie de courant à moins que les lames peuvent être insérées à fond pour l'exposition des lames. Pour réduire les risques de chocs électriques, ne pas retirer le couvercle ou l'arrière du module. Il n'y a pas de pièce utilisable à l'intérieur. Ne faire effectuer l'entretien que par un personnel qualifié.

Notes about Discs

On handling discs

- To keep the disc clean, handle the disc by its edge. Do not touch the surface.
- Do not expose the disc to direct sunlight or heat sources such as shot air ducts, or leave it in a car parked in direct sunlight as the temperature may rise considerably inside the car.
- After playing, store the disc in its case.

On cleaning discs

- Before playing, clean the disc with a cleaning cloth. Wipe the disc from the centre out.
- Do not use solvents such as benzine, thinner, commercially available cleaners, or anti-static spray intended for vinyl LPs.

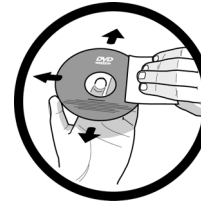

Index

0-9

0-9 2, 22
16x9 Wide 14
2 Channel 15, 16
4x3 Full screen 14
4x3 Letterbox 14
6 Channel 15, 16

A

A-B 2, 28
AM Antenna Input 6
AM Loop Antenna 8
AM/FM 2, 4, 23, 24
ANGLE 3, 26
Antenna Input
 AM 6
 FM 6
ARROW KEYS 3, 4
AUDIO 3, 27
Audio CD 1
Audio Language 13
Audio Setup 14
Audio Setup, More 17

B

BASS/TREB 3, 24, 32
Bass/Treble, Adjusting 24
Bitstream 15, 16, 17
Brightness 29

C

Cable Box 9
CD 1
CD Playback 21
CD/VCD Setting 16
CDDA 1
CD-R 1, 31
CD-ROM 1
CD-RW 1, 31
Center Speaker (C) 7
Chapter Number Indicator 5
Cleaning discs 42
CLEAR 2, 29
Compatible Discs 1
Composite Video 7
Connect
 AM Loop Antenna 8
 Audio/Video Components 9
 FM Wire Antenna 9
 Speakers 8
 TV 7
Customer Service Information 33

D

DISC MENU 3, 22, 30
Disc Menu Language 13
Disc Menu Navigation 22
Disc Tray 4
Discs

Cleaning 42
 Handling 42
DISPLAY 2, 25
Dolby Digital 5.1 1
Dolby Digital Setting 15
DTS Digital Surround 1
DTS Setting 15
DVD Audio 1
DVD Function 21
DVD Indicator 5
DVD Playback 21
DVD Status Indicator 5
DVD Video 1
DVD-ROM 1

E

Edges 29
EJECT 3, 4, 21
Elapsed Time Indicator 5
Energy Star 1
Enhance Video Setting 29
ENTER 2, 4, 11, 22, 30

F

FM Antenna 9
FM Antenna Input 6
Frequently Asked Questions 33
Front Panel Controls 4
Front Panel Display 4, 5

Front Speakers (L, R) 7
FUNCTION 3, 4, 21, 23, 24
Function
 DVD 21
 Tuner 21
 Video 1 21
 Video 2 21

G

GO TO 3, 25, 32

L

L/R 3, 30
L/R Speaker Setting 18
Language Setup 12
Listening to the Radio 24
Low Frequency Effect (LFE)
Output 6

M

MEMORY 3, 23
Menu Tree 45
MiniDisc 9
More Audio Setup 17
MP3 1
MP3 Playback 31
MP3 Setting 16
MUTE 2, 23

O

Optical Out 9
Optical Output 6
OSD Menu Language 12

P

Password 18
 If you forget 19
 Setting 18
Pause Indicator 5
PAUSE/STEP 3, 22
PBC (Playback Control) 30
PCM 15, 16, 17
Photo CD 1
Place Speakers 7
PLAY 2, 22
PLAY/PAUSE 4
Playback Status Indicator 5
Playing
 CD 21
 DVD 21
 MP3 31
 VCD 21, 30
POWER 2, 4, 21
Power 10
PRESET+/- 3, 4, 24
Presetting Radio Stations 23
Pro Logic 9, 16
Pro Logic Setting 17
PROGRAM 2, 29

Program Indicator 5

R

Radio
 Listening 24
 Setting Presets 23
Rating Level 18
Rating Setup 18
Rear Panel 6
Rear Speakers (LS, RS) 7
Region 1 1
Remote Control 2
REPEAT 2, 28
Repeat Status Indicator 5
RETURN 3, 11, 22, 30

S

Safety 38
Satellite Receiver 9
SCAN BACKWARD/FORWARD 2, 22
Sensor 4
SETUP 2, 11, 29
Setup Menu
 Categories 11
 Navigation 11
SKIP BACKWARD/FORWARD 3, 4, 22
SLOW 3, 22
SOUND 3, 4, 30, 32

Speaker Outputs 6

Speaker Status Indicator 5

Speakers

 Balance/Levels 19
 Center 7
 Connect 8
 Front 7
 Placement 7
 Rear 7
 Setup 19
 Subwoofer 7
 Wires 8
ST/MONO 2, 24
Standby mode 10
Stereo/Mono, Adjusting 24
STOP 2, 4, 11, 23
Sub Output 9
SUBTITLE 3, 27
Subtitle Language 12
Subwoofer (SUB) 7
Subwoofer Output 6
SVCD 1
S-Video 7
S-Video Output 6

T

Technical Specifications 35
TEST TONE 3
Test Tone Generator 19
TITLE 2, 26

TRIM 3

Trim Levels 20
Troubleshooting 33
Tuner Function 21
TUNING +/- 23
TUNING+/- 2, 24
TV Aspect 14
TV, Connect 7

V

VCD 1
VCD Playback 21, 30
VCR 9
Video 1 Function 21
Video 1 Input 6, 9
Video 2 Function 21
Video 2 Input 6, 9
Video 2 Output 6, 9
Video CD 1
Video Output 6
Video Setup 14
VOLUME +/- 2, 22
Volume Level 20
VOLUME/CONTROL 4, 22

W,X,Y,Z

Warranty 37
ZOOM 3, 26

:: Setup Menu Tree

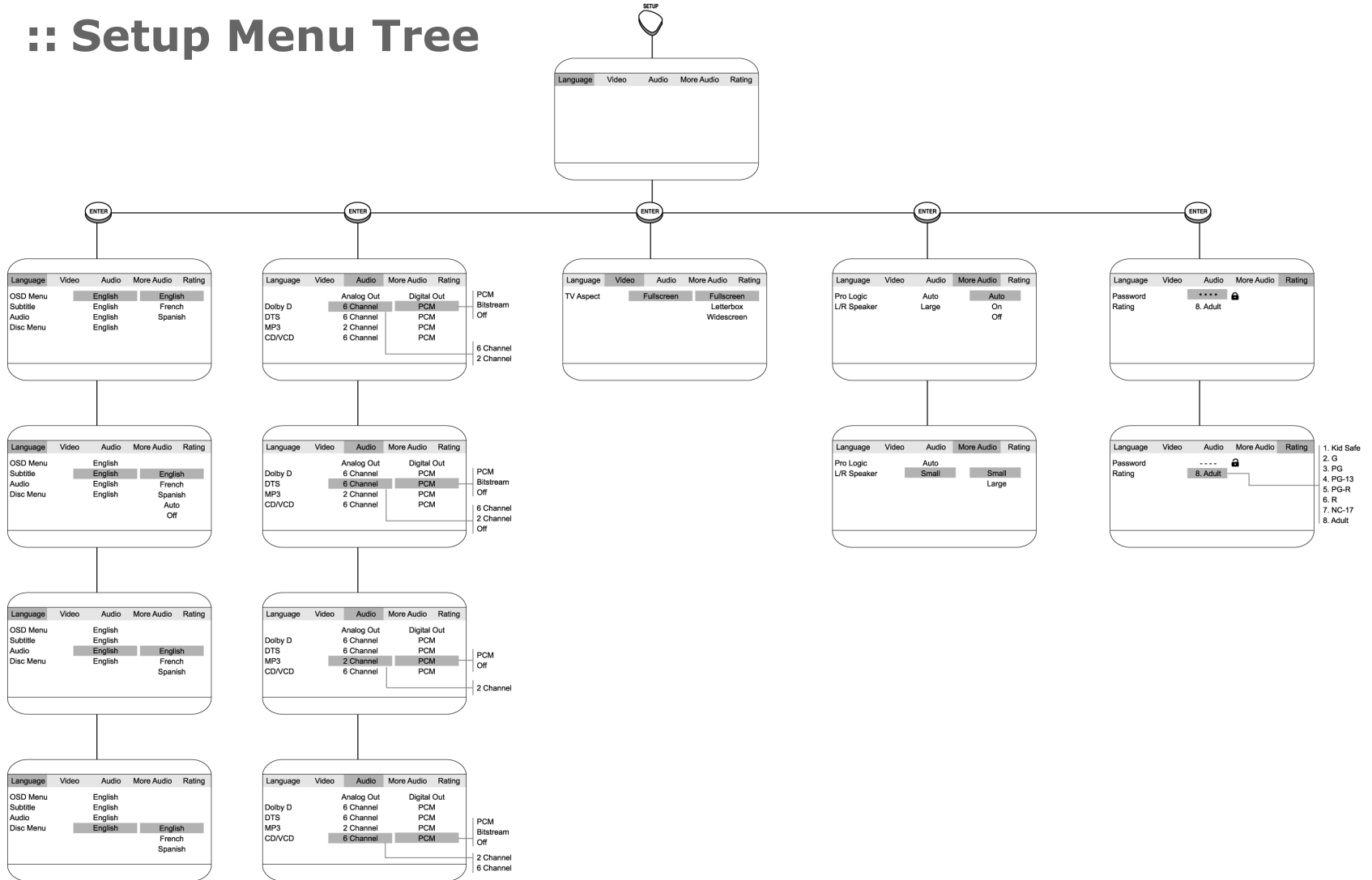

SONIC|blue™