

Fahrenheit

IN -DASH AM/FM
DVD/MP4/VCD/CD/MP3 Receiver
With 4.3 Inch Wide Color Touch Screen TFT
And Slide Down Detachable Panel With
Front Panel USB and SD Card Reader Port

MODEL : TID-436

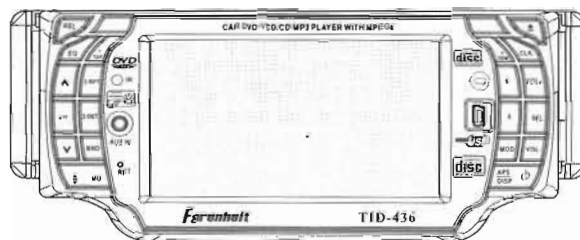
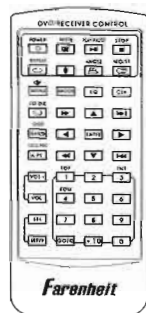

OPERATION MANUAL

Panel Controls

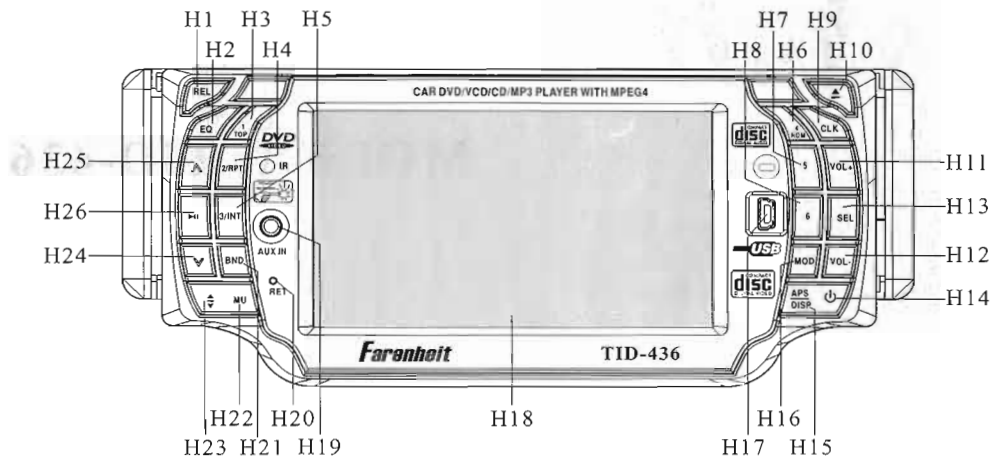

H1. REL (RELEASE)

Press to release the front panel for removal .

H2. EQ

Press to select multi-equilibria mode : pop/rock/jazz/classic/flat .
Press longer to use the Loudness Function .

H3-H4-H5-H6-H7-H8 (1-6 preset station buttons)

In RADIO mode :

Six numbered preset .

Press this buttons to store and recall stations for each band .

In DISC mode :

the detailed method of this buttons, please refer to see page 15 .

H9. CLK

Press to show the clock, press it again to hide the clock . During the time is displaying, press it longer , the hour will flash in the screen, press the vol+/- to adjust the hour . Press briefly again , the minute will flash , press the vol+/- buttons to adjust minute .

H10. ▲ (EJECT)

Press it to insert or eject the disc .

Panel Controls

H11-12. VOL+/- (VOLUME+/-)

Press this knob to adjust the Volume level .

It is also used as an UP/DOWN knob when audio or video settings are being adjusted when accessed using the SELECT button.

H13. SEL (SELECT)

To access the available adjustment settings for audio and video, press it repeatedly to cycle through and select them: Volume-Buzzer-Bass-Treble-Balance-Fader-Color-Bright, etc .

H14. ⏻ (POWER On/Off)

Press briefly to turn ON the unit , press it again to turn off the unit.

H15. APS/DISP

Scan Function

In Radio mode, press the SEL button briefly , the radio Briefly plays all the preset stations of the frequency band .

Automatic Preset Setup

In Radio mode, press and keep for more than two seconds to active automatic station storage. The radio searches within the current frequency band, e.g. Fm2, for the stronger signal level until the search cycle has finished . The six strongest stations are then allocated to the corresponding storage locations .

Then the station of the first storage location is set .

Display ON/OFF Function:

In Disc mode, press the SEL button briefly to turn off the display image (the monitor on the unit only) , the sound will stay on.

(Press it again to resume the playback mode.) Then You can press SEL button repeatedly to select the “BG COLOR”, and then use the VOL+/- to select the background color among of the “AUTO, BG COLOR: 01.....BG COLOR: 11”, in “AUTO”mode, the monitor will change the background color automatically .

H16. MOD

Press it to select the input mode, such as : Radio, AUX, etc .

H17. USB CONNEXION

If you would like to play back the data contained on a USB stick, you can use the supplied adapter cable for this. Refer to see page 28 .

H18. TFT DISPLAY

H19. AUX JACK

To connect analogue replay devices. Use this jack to replay sound of other replay equipment such as DVD players, computers, etc .
Via the loudspeakers.

H20. RESET

Press this button with a pointed object to restart .

H21. BAND

In radio mode, press this button repeatedly to select the desired radio band: FM1 -FM2- FM3- AM1(MW1)- AM2(MW2) .

H22. MU

Press it to select the MUTE or NOT MUTE .

H23. ⬆

Changing the viewing angle of the operating unit .

Panel Controls

H24-25. ▽ / ▲

In Disc playback, press briefly the ▽ / ▲ buttons to jump back/next chapter. press and hold (more than two seconds) to fast backward/fast forward chapter . (Note: during the DVD playback, press continually the ▽ button twice to skip back one track .)

DVD/VCD/CD/MP3: Normal Playback 2x → 4x → 8x → 16x

In Radio mode, briefly press the ▽ / ▲ buttons to set the radio station manually , press and hold (more than two seconds) to start search the radio station automatically .

H26. ▶ (PLAY/PAUSE)

In Disc Playback Mode

Press it to pause playback, press it again to cancel this function .

Remote Controls

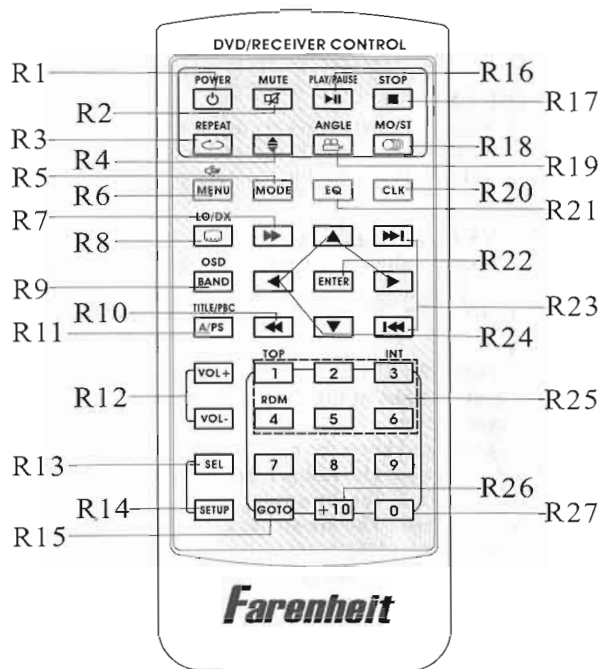

Remote Controls

R1. (POWER)

Press to turn unit ON, press it again to turn the unit OFF.

R2. MUTE

press it to select the MUTE or NOT MUTE .

R3. REPEAT

Press to select Chapter Repeat, Title Repeat or Repeat Cancelled

R4.

Changing the viewing angle of the operating unit .

R5. MODE

Press it to select the DVD/CD, Radio, Aux in, inputs function .

R6. MENU/ (SUBWOOFER)

While playing a DVD, pressing this key displays the disc's options menu . Press it longer to switch the SUBWOOFER function ON and OFF .

R7.

In Disc mode, press to start forward rapidly .

R8. SUBTITLE (LO/DX)

Press to change the SUBTITLE language on multi-subtitle language DVD disc. In radio mode, press it button for distance reception when you are located at weak signal location, press this button for stronger signal .





R9. OSD(BND)

In radio mode, press to select the desired band . In disc mode, press it to display the information of the disc in playing .

R10.

In Disc mode, press to start reverse rapidly .

R11. TITLE/ PBC (A/PS)

Press this button to display the title menu included on DVD video discs . Use the  /  /  /  buttons to select the desired item , press ENTER to confirm . In VCD mode, press this key to shift the PBC mode .
In radio mode, press shortly to scan preset station; press it button to enter automatic memory storing function .

R12. VOL+/-

Press to increase / decrease the volume level .

R13. SEL

Press SEL button to display the corresponding menu .

R14. SETUP

Press this button to display the SETUP menu in DVD mode .

R15. GOTO

Disc search button, cooperatively used with numeric buttons .

R16. PLAY/PAUSE ()

Press this button to pause the program, press it to resume the normal playback .

Remote Controls

R17. STOP (■)

Press to stop the playback .

R18. MO/ST (Ⓜ)

In Radio Mode, press to switch stereo and mono .

In Disc Mode, press to change the Audio settings (depending on your DVD .)

R19. ANGLE (Ⓜ)

press it to change the view angle on multi-angle DVD disc.

R20. CLK

press to display the clock, press it again to hide . When the time display, press this button longer to set the time .

R21. EQ

press to preset the equaliser function . Press longer to switch the LOUDNESS function ON and OFF .

R22. ENTER

Confirm a selection .

R23. ► / ◀

Skips to the next chapter; skips to the previous chapter .

R24. ◀ / ▶ / ▲ / ▼

In case of MENU mode, this buttons served as cursor buttons to select the item left/right, ahead/back .

R25. RADIO PRESET (1-6)

press briefly (1-6 button) to select the station , press longer to storage the station .

R26. +10

Digital selecting button .

R27. 0-9

Numeric buttons .

Safety Information

SAFETY

As the laser beam used in the DVD player may be harmful to the eyes, do not attempt to disassemble the cabinet . Refer servicing to qualified personnel only (it is perfectly safe if you do not unscrew and open the cabinet .)

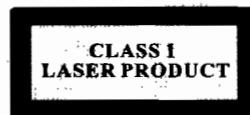

IMPORTANT INFORMATION FOR SAFE OPERATION

for safety reasons, the driver should not watch video or operate the DVD player while driving. Please note that it is illegal in certain countries to watch or operate a video source whilst driving .

WARNING:

TO REDUCE THE RISK OF FIRE OR ELECTRIC SHOCK, DO NOT EXPOSE THIS EQUIPMENT TO RAIN OR MOISTURE. TO REDUCE THE RISK OF FIRE OR ELECTRIC SHOCK, AND ANNOYING INTERFERENCE, USE ONLY THE RECOMMENDED ACCESSORIES. THIS DEVICE IS INTENDED FOR CONTINUOUS OPERATION.

COPYRIGHT PROTECTION

This Product Incorporates Copyright Protection Technology That Is Protected By Method Claims Of Certain U.s. Patents And Other Intellectual Property Rights Owned By Macrovision Corporation And Other Rights Owners. use Of This Copyright Protection Technology Must Be Authorized By Macro Vision Corporation, And Is Intended For Home And Other Limited Viewing Uses Only Unless Otherwise Authorized By Macrovision Corporation. Reverse Engineering Or Disassembly Is Prohibited.

REGION CODE INFORMATION

this mobile DVD player is designed and manufactured to play DVD discs with region codes that is recorded on it .





Contents

Panel Controls	1
Remote Controls	3
Safety Information	6
Contents	7
Notes On Discs	8
Electrical Connection	9
Installation Instruction	10
Detaching the Front Panel	12
Panel Angle Adjustments	12
Basic Operation	14
Resetting the unit -RESET	14
Setting the TIME	14
Adjusting the Scroll Caption	14
Setting the BUZZER function	14
Using the ZOOM function	14
Using the Number buttons	15
Using the Touch screen	16
On Screen Display	19
Special DVD Features	20
Changing Subtitle language	20

Changing Audio Soundtrack language	20
Viewing from another angle	20
Using a Title Menu	20
DVD Setup	21
Selecting General Setup	21
Selecting Speaker Setup	24
Selecting Dolby Setup	24
Selecting Preference Setup	24
Defaults Table	26
Other main operation	27
Playing the MP3/WMA/JPEG/MPEG4	27
AUX Operation	27
USB / SD Card Reader Operation	28
Trouble Shooting	29
Specification	30

Notes On Discs

The following types of discs can be played by this unit :

Disc type	Logo mark	Size	Recorded content
DVD		12cm	Audio + Video
VCD		12cm	Audio + Video
Music CD		12cm	Audio only
CD-R disc		12cm	Audio only or Audio /Video
CD-RW disc		12cm	Audio only or Audio /Video
Mp3 disc		12cm	Audio only

Formats which are not supported :

DVD-ROM

DVD-RAM

CDV

CD-G

PRECAUTIONS FOR DISC

Handling Disc

- To keep the disc clean, do not touch the playback sides of the disc . Every fingerprint can cause playback problem.

Do not scratch the disk ,

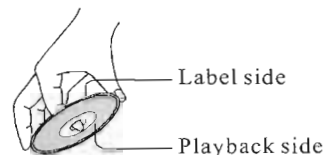

- Do not attach paper or tape to disc .

Note: if the playback side gets scratched it may not play any more. Be careful and store discs only in their cases immediately after use .

Storing Discs

- Do not store the discs in a place subject to direct sunlight or near heat sources .
- Do not store discs in places subject to moisture and dust such as bathroom or near a humidifier .
- Store discs vertically in a case. Stacking or placing objects on discs outside of their case may cause warping or scratching of the disc, and permanently damage the disc .

Cleaning Discs

- before playing , make sure the disc is clean, if not clean, the DISC with a cleaning cloth, wipe the DISC in a straight motion from the center not .

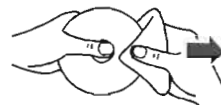

Electrical Connection

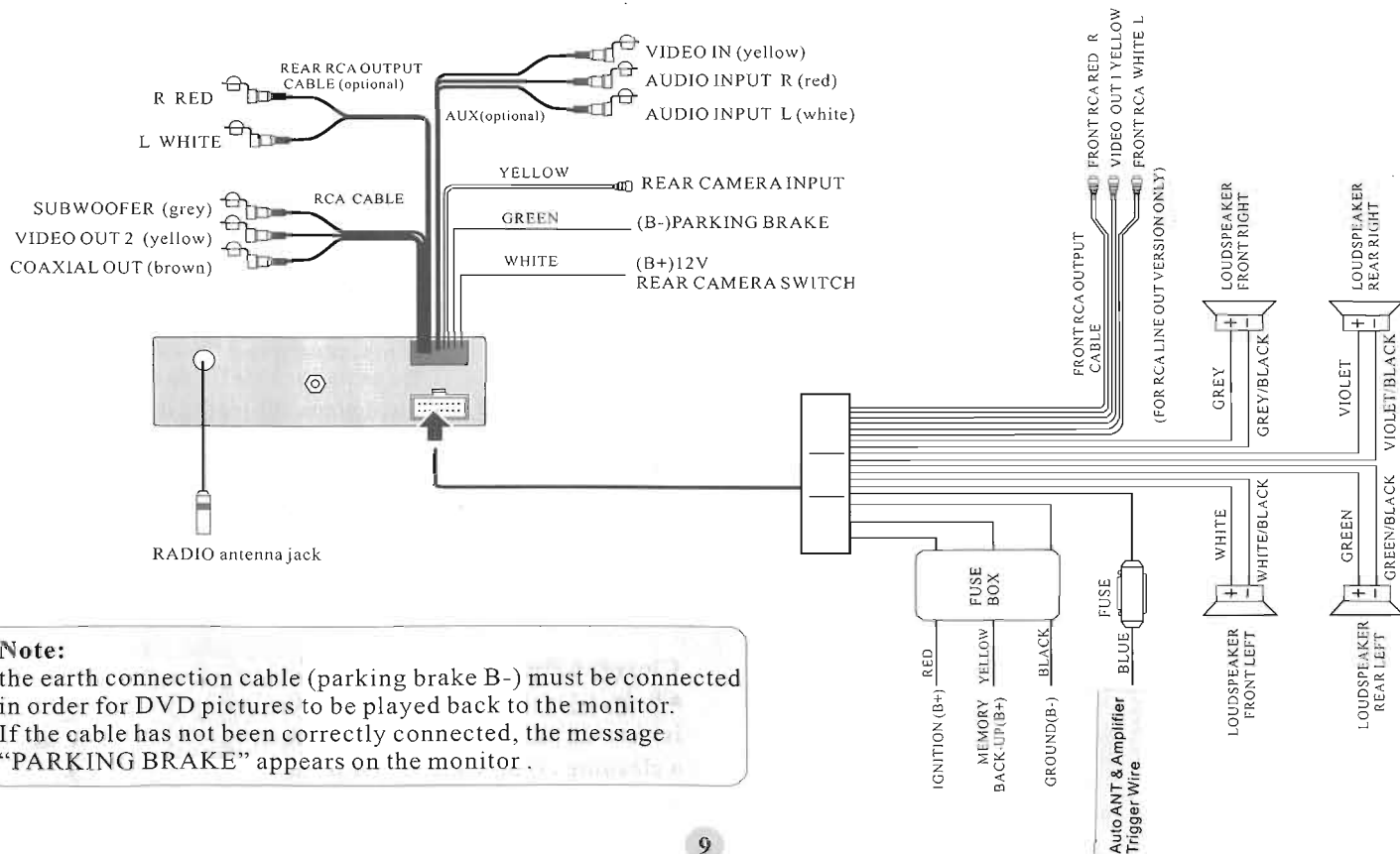

Installation Instruction

Mounting the Unit

Do not install the unit where it would be subject to high temperature, such as from direct sunlight, or from the heater, or where it would be subject to dust, dirt or excessive vibration. Sufficient air circulation is essential for the perfect function of the unit .

DIN Front/Rear-Mount

This unit can be properly installed either from "Front"(conventional DIN Front-mount) or "Rear"(DIN Rear-mount installation, utilizing threaded screw holes at the sides of the unit chassis).

For details, refer to the following illustrated installation methods.

Note:

- Before finally installing the unit, connect the wiring temporarily and make sure it is all connected up properly and the unit and the system work properly.
- Use only the parts included with the unit to ensure proper installation. The use of unauthorized parts can cause malfunctions.
- Consult with your nearest dealer if installation requires the drilling of holes or other modifications of the vehicle.
- Install the unit where it does not get in the driver's way and can not injure the passenger if there is a sudden stop, like an emergency stop.

- If the installation angle exceeds 30° , the unit might not perform well .

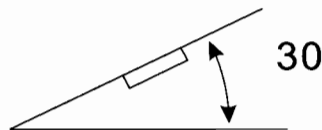

Installation Instruction

Please install the car player as shown below :

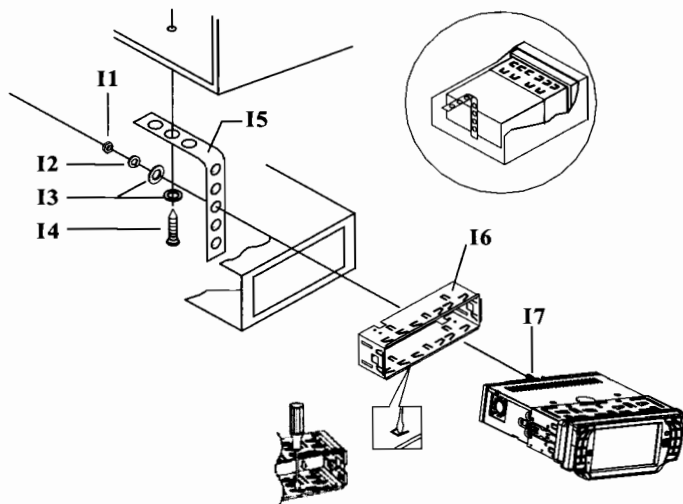

I1. NUT

I2. Spring Washer

I3. Plain Washer

I4. Screw

I5. Mounting Bracket

I6. Slide-in Housing

I7. Threaded Bolt

Remove the unit as shown below :

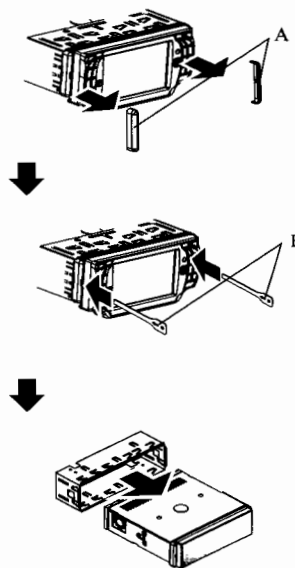

A. Screen cover

B. Extraction tool

Note :

If you want to take the unit out of the SLIDE -IN HOUSING , first remove the SCREEN COVER of the both sides away, then insert the two EXTRACTION TOOL into left and right side of chassis as above illustration.

Installation Instruction

Detaching The Front Panel

1). Press REL (release) button on the front panel . the left hand side of the front panel will release,

Release button



2). The front panel will come out towards you , Pull-off it and keep the front panel into the case .

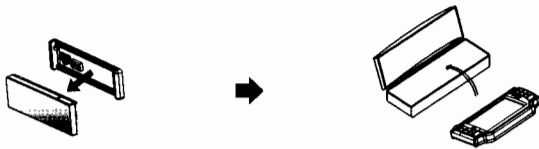

Replacing The Front Panel

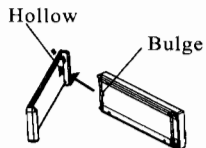

1). First insert the right hand side of the front panel into the unit .
(Note : must be insert into the hollow of the unit .)

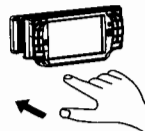

2). Gently push the left hand side of the front panel until it locks firmly into the main unit .



PANEL ANGLE ADJUSTMENT

If you would like to change the viewing angle of the operating unit, press the  button or touch  section on the touch screen .

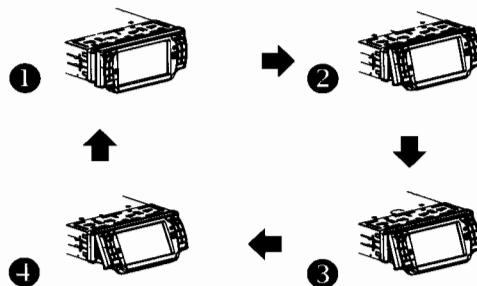

WARNING:

Don't place your fingers behind the operation unit. There is a danger of injury if the operating unit return to the normal position .

Installation Instruction

Preparing the Remote Control

Insert the Batteries (lithium batteries)

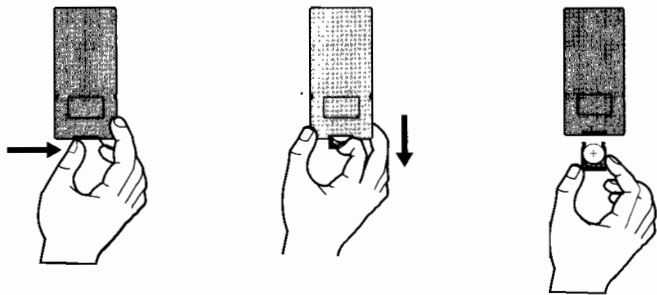

1. push to inside as the direction indicated by the arrow then Remove the battery holder as the direction indicated by the arrow
2. Insert the battery with + facing in the same direction as the + on the battery folder as illustrated .
3. Insert the battery holder. Push in the holder to original position .

Replacing the button-type battery

if the remote control fails to operate the unit when used within the operation range , please replace it .

NOTE :

1. Face the remote control towards the player front face IR mark (remote control signal receiver).
2. About ± 30 degree in each the direction of the front of IR mark.
3. The distance between remote control and sensor should not exceed 5M .

Precaution :

Before initial use please remove this foil so that the remote control is ready for operation .

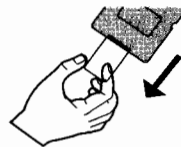

WARNING :

Never throw batteries into the fire, there is a danger of explosion !

Basic Operation

Operation Instruction

1. In order to keep the removable panel in a safe place you should always use the protective case provided .
2. Some key are to be found both on the device itself and on the remote control, keys with the same designation have the same function .

Resetting the unit -RESET

The RESET button has to be activated for the following reasons:

1. the player does not respond to any of the function buttons .
2. initial installation of the unit when all wiring is completed .
3. all the function buttons do not operate .

Note: activate the RESET button with either a ballpoint pen or thin metal object .

Setting the Time

1. Press the CLK button on the remote control (or touch the CLK section on the touch screen) to bring up or hide the clock .
2. To set the time keep the CLK button pressed down for a more than two seconds, the hours flash in the display , Use the VOL+/- knob to adjust . press it button again , the minutes now flash, use the VOL+/- to adjust the minutes .
Press the CLK button again to store .

Adjusting the Scroll Caption

In Radio Mode

- 1). Press and hold (for more than two seconds) the SETUP button on remote control, the adjustment scroll in the display .
- 2). Press the VOL+/- knob in order to select the letter among of “A, B ,CZ, and BLANK” , and then press the ∇/\blacktriangle buttons on the front panel to proceed/cancel, press the SETUP button to confirm . (Press it longer again to start setting .)

Setting the BUZZER function

If you would like to use the BUZZER (confirmation tone), you may press the SEL knob repeatedly to select the BUZZER item, then use the VOL+/- to switch the buzzer ON and OFF .

Using the ZOOM function

You can use the ZOOM to enlarge the video image .

1. Touch the zoom range on touch screen during playback .
2. Each touch of the zoom range changes the TV screen in the sequence : normal size →x2 size →x3 size →x4 size → x1/2 size → x1/3 size → 1/4 size .
3. Touch the navigation $\blacktriangle/\blacktriangledown/\blacktriangleright/\blacktriangleleft$ sections on touch screen (or press $\blacktriangle/\blacktriangledown/\blacktriangleright/\blacktriangleleft$ buttons on remote control) to move through the zoomed picture .
4. Touch Zoom range repeatedly to resume the normal playback .
Note : during the JPEG disc playback, touch the ZOOM section, “zoom 100 %” appears on the screen, touch and hold (for more than two seconds) the $\blacktriangle\blacktriangle/\blacktriangle\blacktriangleleft$ section on touch screen (or press the $\blacktriangle\blacktriangle/\blacktriangle\blacktriangleleft$ button on remote control) to increase/decrease in size .
Use the navigation buttons to move the enlarged picture .

Basic Operation

Using the Number Buttons: (on front panel / remote control)

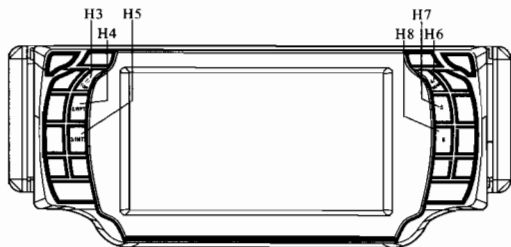

H3, H4, H5, H6, H7, H8 buttons on front pane (Numerical buttons 1-6 on the remote control) as station buttons (1-6) of preselected stations and as 1/TOP, 3/INT, 4/RDM buttons on the remote control during DISC operation .

1. Radio Operation

pressing these buttons (1-6) briefly directly selects a preset radio station. If these buttons are pressed and hold for more than two seconds , the station currently being listened to is stored under the selected station button .

2. DISC Operation

pressing briefly directly selects the corresponding CD/MP3 track, keep the corresponding button (1/TOP, 2/RPT, 3/RDM) pressed for about two seconds to switch the following functions On and Off .

1)> press the 1/TOP button to jump to the first track of the CD/MP3.

Note: No function during the DVD operation .

2)> press the 2/RPT button longer , the track currently being played is repeated. Press it button longer again to turn off this function .

In DVD mode, you can repeat the chapter, title or the entire DVD .

3)> press the 3/INT button longer , each track on the CD is played for six seconds . Press it longer to stop searching . The currently selected track is played .

A. In VCD disc playing, press the 3/INT longer , the information will display as following : (press it longer again to turn off .)

SELECT DIGEST TYPE:
TRACK DIGEST
DISC INTERVAL
TRACK INTERVAL

Here you can use the ▲, ▼, ►, ◀ buttons to select the desired item , then press the ENTER button to confirm .

B. In DVD disc playing, press the 3/INT longer , the information will display as following : (press it longer again to turn off)

SELECT DIGEST TYPE:
TITLE DIGEST
CHAPTER DIGEST
TITLE INTERVAL
CHAPTER INTERVAL

Here you can use the ▲, ▼, ►, ◀ buttons to select the desired item , then press the ENTER button to confirm .

Note: No function during MP3 operation .

4)> press the 4/RDM button longer, the DVD, MP3/CD tracks are played at random. Press it longer again to cancel this function .

Note: In random mode , press ◀ buttons is not available .

Basic Operation

Using The Touch Screen

Operating the device by the buttons, the device itself and with the remote control, it is also possible to use the touch screen. Touch the TFT screen of the device lightly with one of your fingers. The respective main menu of the individual modes is displayed. Touch the buttons shown lightly in order to perform the functions, a brief overview is to be found in the following section :

Note:
if no selection is made within about 10 seconds, the touch screen menu disappears again.

Radio mode

Press the MOD button to select the Radio mode, the information will display as follow :

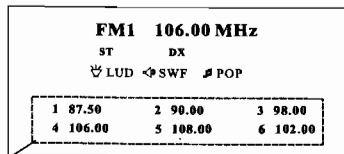

 You can use your finger to select the desired the band to heard.

touch the screen, the information will display as follow :

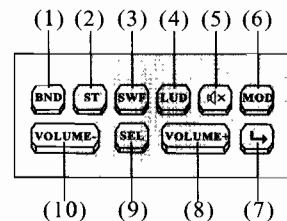

 Use the finger to select your desired function.

- 1 Touch it to switch the 3FM and 2AM (MW) levels.
- 2 Touch to select the Mono or Stereo mode.
- 3 Touch it to switch the Subwoofer Function ON and OFF.
- 4 Touch it to switch the Loudness Function ON and OFF.
- 5 Touch it to switch the MUTE function On and Off.
- 6 Touch repeatedly it to select the input mode (CD/DVD, AUX in Radio, ect.)
- 7 Touch to select next menu.
- 8 Touch to increase the volume level.
- 9 Touch briefly to select the Audio/Video mode.
- 10 Touch to decrease the volume level.

Basic Operation

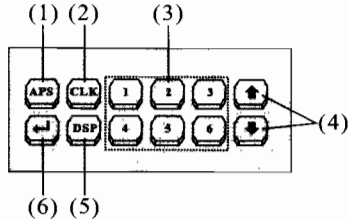

- 1 Touch briefly to scan the stored radio stations .
Touch longer to store the stations automatically .
- 2 Touch briefly to hide/display the clock .
Touch it longer to set the time .
- 3 Touch briefly to select the station .
Touch and hold longer to store the station .
- 4 Touch briefly to search the station manual .
Touch and hold longer to search the station automatically .
- 5 Touch to select the equalizer setting .
- 6 Previous

CD/DVD mode

Touch the MOD section on touch screen or Press the MOD button to select the DISC mode, the information will display as follow :

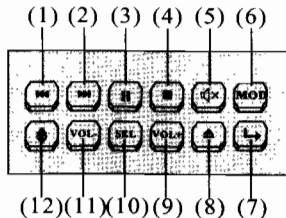

☞ Use the finger to select your desired item .

- 1 Jump to the previous track .
- 2 Touch to select the next track to play .
- 3 Touch to pause the playback, touch again to start playback .
- 4 Touch it stop playback .
- 5 To switch of the sound .
- 6 Touch to select the input mode .
- 7 Next menu .
- 8 Touch to insert or eject the disc .
- 9 Touch it to adjust the volume level (volume+)
- 10 Touch shortly to select the Sound/Video mode .
- 11 Touch it to adjust the volume level (volume-)
- 12 Touch it to change the angle of the front panel .

☞ Touch the screen of “☞” section to select the next menu, the message will display in the screen :

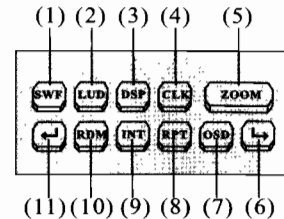

- 1 Subwoofer Function .
- 2 Loudness Function .
- 3 Touch it to set the equalizer (pop, rock, classic, jazz, flat) .
- 4 Touch briefly to hide/display the clock .
Touch it longer to set the time .
- 5 ZOOM in and out the picture . (Please refer to see page 14 .)

Basic Operation

- 6 Touch it to select the next menu .
- 7 Alternating the time display .
- 8 Touch to select repeat function .
- 9 Touch to select the scan function .
- 10 Touch it to select the random playback .
- 11 Previous .

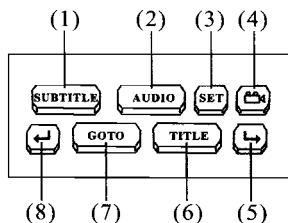

- 1 Touch to display the subtitle (depending on the DVD) .
- 2 Touch to change the Audio settings (depending on the DVD) .
- 3 Touch it to display the SETUP menu .
- 4 Touch it to select the viewing angle . (Depending on the DVD .)
- 5 Touch it to select the next menu .
- 6 Touch it to show the title menu of the DVD (depending on DVD).
Touch it to show the playback-control for VCD .
- 7 For direct accessing of a section on the CD/DVD .
- 8 Touch to select the previous menu .

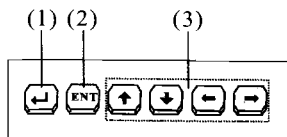

- 1 Touch to select the previous menu .
- 2 Touch to confirm input item .
- 3 Cursor buttons .

AUX mode

Touch the MOD section on touch screen or Press the MOD button to select the AUX IN mode, the information will display as follow :

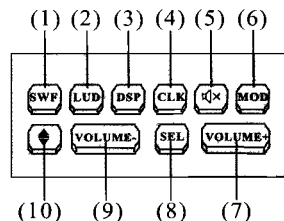

- 1 Subwoofer Function .
- 2 Loudness Function .
- 3 Touch to select the equalizer setting .
- 4 Touch briefly to hide/display the clock .
Touch it longer to set the time .
- 5 MUTE Function
- 6 Touch it to select the input mode .
- 7 Touch it to increase the volume level .
- 8 Touch to select the Audio/Video menu .
- 9 Touch it to decrease the volume level .
- 10 Touch to change the viewing angle of the main unit .

On Screen Display

Displaying Disc Information On-Screen

You can display the general playback status about the disc loaded on the screen .

1. Touch or Press the OSD to show various playback information .
The items displayed differ depending on the disc type of playing status .
2. Title Number, Total Title Number, Chapter Number, Total Chapter Number of this Title of the disc currently being played will be shown on the screen, along with the elapsed time.

Example for DVD :

- 1 Touch OSD for first time

TITLE ELAPSED
T 01/01 C 01/38 0:02:06

- 2 Touch OSD for second time

TITLE REMAIN
T 01/01 C 01/38 3:24:36

- 3 Touch OSD for third time

CHAPTER ELAPSED
T 01/01 C 01/38 0:02:56

- 4 Touch OSD for fourth time

CHAPTER REMAIN
T 01/01 C 01/38 0:04:32

- 5 Touch OSD for fifth time

The information on the screen will be cleared.

Example for VCD/CD :

- 1 Touch OSD for first time

SINGLE ELAPSED
TRACK 01/16 0:00:56

- 2 Touch OSD for second time

SINGLE REMAIN
TRACK 01/16 0:05:10

- 3 Touch OSD for third time

TOTAL ELAPSED
TRACK 01/16 0:31:38

- 4 Touch OSD for fourth time

TOTAL REMAIN
TRACK 01/16 0:36:26

- 5 Touch OSD for fifth time

The information on the screen will be cleared.

NOTE:

1. For CD and MP3, the message will always display on the screen.
2. If no button is pressed for a few seconds, the on-screen display disappears .

3.Example for MP3:

Each time **OSD** is pressed or touch , the message displayed on screen changes as follows:

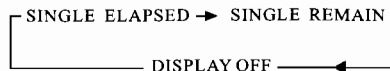

Special DVD Features

DVD/VCD Special Function

To select the subtitle language (SUBTITLE)

Some DVD VIDEO discs contain more than one subtitle language. You can choose a desired one from them .

1. Touch the SUBTITLE range on touch screen during playback .
The subtitle selection window appears on the screen .
2. Touch the SUBTITLE repeatedly to make a selection
each time you press SUBTITLE, the subtitle language changes .
3. Touch the SUBTITLE repeatedly to turn the subtitle off .
Press the subtitle until the SUBTITLE OFF message appears .

Note :

- The language number is different according to the disc.
- Some discs only contain one subtitle language.

To change the Audio Language or Sound (LANGUAGE)

The audio selection setting allows you to change the audio language of a movie .

During the DVD playback

1. Touch the AUDIO range on touch screen during playback .
The audio selection window appears on the screen .
2. Touch the AUDIO repeatedly to make a selection Each time
the button is pressed or touch , number of the audio soundtrack
language changes on sequential order.

For VCD/CD:

during playback, touch the **AUDIO** section of the touch screen or Press **AUDIO** on the remote . It is possible to switch the sound between monaural and stereo sound.

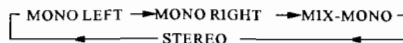

Note :

- The language number is different according to the disc.
- Some disc only contain one language soundtrack

To select a scene angle of the DVD VIDEO (ANGLE)

you can enjoy a variety of scene angles if the DVD VIDEO disc contains “Multi-angle” parts, where multiple cameras were used to shoot the same scene from different angles .

1. During DVD playback, touch the  section or Press ANGLE button on the remote, the angle selection window appears on the screen .
2. Each time the button is pressed or touch, number of the angle changes in sequential order.

Notes:

- The angle number is different according to the disc.
- The function only work for disc having scenes recorded at different angles.

Title Menu Function

For DVD:

If the DVD has multiple titles recorded on the disc. It can select preferred title from the title menu to start playback.

1. During DVD playback, Touch the TITLE section or press TITLE button on the remote .The title menu is display.
2. touch the cursor button shown in TV screen, select preferred title by the cursor button and confirmed by touch ENT button .

Cautions :

if there is no information , the  symbol is displayed .

DVD SETUP

By using the DVD setup menu, you can set the various adjustments to items such as picture and sound. You can also set the language for the subtitle and the setup menu , among other things .

Navigating the SETUP page:

Touch the SET section on the touch screen (Or press the SETUP button on the remote control) to display the setup menu, the setup menu will appear as below :



TV Display	LB
Angle Mark	ON
OSD Lang	ENG
Spdif Output	
Captions	ON
Screen Saver	ON
Last Memory	ON

Go To General Setup Page

General Operation

1. Touch → or press ► on remote control to go to the next level .
2. Touch ← or press ◀ on remote control to go back to the previous level .
3. use ▲ /▼ to select the desired option then press ►to move to the second level . The screen shows the current setting for the selected item, as well as alternate settings .
4. Use ▲ /▼ to select the desired setting then press ENTER or touch the ENT range on touch screen to confirm your selection.
5. Touch the SET section on touch screen or press the SETUP button on the remote control to exit the SETUP menu completely .

The icons on the top of the setup menu represent as follows :

	General Setup Page
	Speaker Setup Page
	Dolby Digital Settings
	Preference Page

General Setup Page



TV Display	LB	Normal/PS
Angle Mark	ON	Normal/LB
OSD Lang	ENG	Wide
Spdif Output		
Captions	ON	
Screen Saver	ON	
Last Memory	ON	

Set TV Display Mode

1. TV DISPLAY : Normal/PS, Normal/LB, WIDE
 - a. Normal/PS: "PS" stands for "pan scan" . Select the option when the unit is connected with a normal (4:3 aspect ratio) TV . If a wide-screen image is display on the screen, some left and right edges of the image are cut out automatically .
 - b. Normal/LB : "LB" stands for "letter box" . Select the option when the unit is connected with a normal (4:3 aspect ratio)TV.

DVD SETUP

If a wide-screen image is displayed on the screen, the back strip at both the top and bottom of the screen .

- c. WIDE: Select this option when the unit is connected to a wide-screen (16:9 aspect ratio) TV .

4:3 pan scan



4:3 letter box



16:9



TV Display	LB	
Angle Mark	ON	ON
OSD Lang	ENG	OFF
Spdif Output		
Captions	ON	
Screen Saver	ON	
Last Memory	ON	

Set Angle Mark

2. Angle mark : ON/OFF

ON: if selected, it will show the angle mark on the screen when playing a DVD recorded with multi-angle view . This only works when there is an angle mark on the disc .

OFF: if is set to OFF, the angle will not be shown on the screen .



TV Display	LB	
Angle Mark	ON	English
OSD Lang	ENG	French
Spdif Output		German
Captions	ON	Spanish
Screen Saver	ON	Italian
Last Memory	ON	Portuguese

Set OSD Language

3. OSD LANG:

Used to change the on-screen display language .



TV Display	LB	
Angle Mark	ON	Spdif/OFF
OSD Lang	ENG	Spdif/RAW
Spdif Output		Spdif/PCM
Captions	ON	
Screen Saver	ON	
Last Memory	ON	

Setup SPDIF

4. SPDIF OUTPUT:

Select the "SPDIF OUTPUT" use this option to select the audio signal output . SPDIF/OFF: the digital signal audio output will be off . SPDIF/RAW: the signal audio output is RAW . SPDIF/PCM: the signal audio output is PCM .

DVD SETUP



TV Display LB
Angle Mark ON
OSD Lang ENG
Spdif Output
Captions ON ON
Screen Saver ON OFF
Last Memory ON
Closed Caption

5. Captions: ON/OFF

Select the "Captions" using the up/down key .

(* ON: captions on. * OFF: captions off.)



TV Display LB
Angle Mark ON
OSD Lang ENG
Spdif Output
Captions ON
Screen Saver ON ON
Last Memory ON OFF
Screen Saver

6. Screen Saver: ON/OFF

Select the "screen saver" using the up/down button .

(* ON: screen saver on. * OFF: screen saver off.)

Note: the screen saver image appears when the unit stops or the image is motionless for approximately 5 minutes . This saver can keep the screen from being damaged .



TV Display LB
Angle Mark ON
OSD Lang ENG
Spdif Output
Captions ON
Screen Saver ON ON
Last Memory ON OFF

Set last memory State

7. Screen Saver: ON/OFF

Select the "screen saver" using the up/down button .

ON: the unit will retain the last position of the playback in the memory .

OFF: the unit will not retain the last position of the playback .

DVD SETUP

Speaker Setup Page



DOWNMIX

LT/RT

STEREO

Set Stereo Downmix

Speaker Setup : LT/RT, STEREO

- a. LT/RT: select to hear the sound in the theatrical Downmix mode .
- b. STEREO : select to hear the sound in the stereo Downmix mode .

DOLBY Setup Page



DYNAMIC

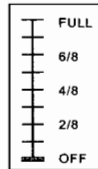

Dynamic Range Compression

Dolby Setup :

you can select the level of the dynamic range compression in the radio output . There are 8 steps between full compression and OFF compression .

Preferences Setup Page

1. TV type : PAL/AUTO/NTSC

PAL: when connected to a PAL TV system, this option must be selected to display an image correctly .

AUTO: when select the AUTO format, the player TV output format will according to the DVD disc format .

NTSC: when connected to a NTSC TV system, this option must be selected to display an image correctly .



TV Type

NTS

PAL

Audio

ENT

AUTO

Subtitle

OFF

NTSC

Disc Menu

ENG

Parental

Password

Default

Set TV Standard

2. AUDIO language

To change the audio language, Choose the language using the Navigation (▲ / ▼) buttons and press the ENTER button to confirm . (* if the disc does not have the selected language, the disc's default language will be used .)

DVD SETUP

Preferences Setup Page



TV Type	AUTO	
Audio	ENT	English
Subtitle	OFF	french
Disc Menu	ENG	german
Parental		spanish
Password		italian
Default		protuguese

Preferred Audio Language

3. SUBTITLE :

To change the subtitle language, Choose the language using the Navigation (▲ / ▼) buttons and press the ENTER button to confirm . (* if the disc does not have a subtitle in the language, the disc's default language will be used .)



TV Type	AUTO	English
Audio	ENT	French
Subtitle	OFF	German
Disc Menu	ENG	Spanish
Parental		Italian
Password		Protuguese
Default		ON

Preferred Subtitle Language

4. DISC MENU :

To change the language of the menu, Choose the language using the ▲ / ▼ buttons and press the ENTER button to confirm .



TV Type	AUTO	
Audio	ENT	English
Subtitle	OFF	French
Disc Menu	ENG	German
Parental		Spanish
Password		Italian
Default		Protuguese

Preferred Menu Language

5. PARENTAL :

Select the parental level you desire using the up/down for discs with lock-out function or multiple rating levels . These are listed from the lowest level (1 Child) to the lightest level (OFF) .



TV Type		
Audio		4PG13 ▲
Subtitle		5PGR
Disc Menu		6R
Parental		7NC 17
Password		8ADULT
Default		OFF

Set Parental Control

DVD SETUP

6. PASSWORD :

you can change the password to PREFERENCES SETUP so that settings within, such as PARENTAL , can only be changed by you. The factory default password is "1379". Enter the current password and new password (twice) to change .
 (* Password must consists of 4 digits .)



TV Type
 Audio
 Subtitle
 Disc Menu
 Parental
Password
 Default

CHANGE

Change Password

7. DEFAULT :

Select "RESET" to revert to default (initial) factory settings .



TV Type
 Audio
 Subtitle
 Disc Menu
 Parental
 Password
Default

RESET

Load Factory Setting

DEFAULTS TABLE

GENERAL SETUP	TV DISPLAY	NORMAL/LB
	ANGLE MARK	ON
	OSD LANGUAGE	ENGLISH
	SPDIF OUPUT	SPDIF/RAM
	CAPTIONS	ON
	SCR SAVER	ON
LAST MEMORY	ON	
SPEAKER SETUP	DOWNMIX	STEREO
DOLBY DIGITAL	DYNAMIC	OFF
PREFERENCES	TV TYPE	AUTO
	AUDIO	ENGLISH
	SUBTITLE	OFF
	DISC MENU	ENGLISH
	PARENTAL	8 ADULT
	PASSWORD	1379

Other Main Operation

Playing MP3/WMA/JPEG/MPEG4

this unit can play the MP3/WMA/JPEG/MPEG4 disc, when you load the MP3 disc into the player, a menu will appears on screen .

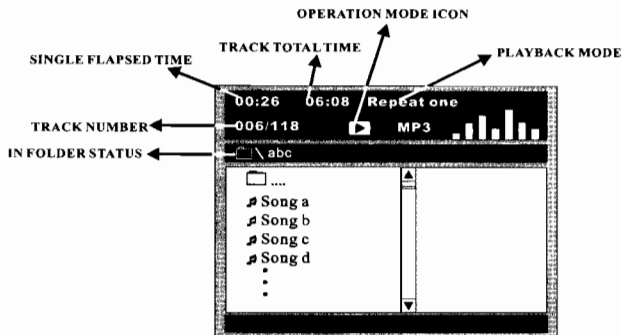

1. Touch the direction keys \uparrow/\downarrow on touch screen or press the $\blacktriangle/\blacktriangledown$ button on remote control to select the folder, then touch the ENT range or press the ENTER to enter the folder , use the UP/DOWN button to select the desired file in the folder, and then touch " ENT " range or press ENTER button to start playing the mp3 file . The play " ▶ " indication will display on the screen .
2. You may use the \ll or \gg on touch screen or on remote control to skip to the back or the next track . (You can also swing SEL knob in the ∇/\blacktriangle direction on front panel to skip a track ahead or back.)
3. Press the \ll / \gg button for fast backward /fast forward play .
4. During the playback, press the corresponding Numeric buttons to the MP3 file number to select your desired MP3 file. It will jump to the selected MP3 file, then press ENTER to confirm .
5. To repeat a MP3 file: (pressing the REPEAT button repeatedly to select the repeat play mode .)

REPEAT ONE

play the same song over and over again .

REPEAT FOLDER

play all songs in the discover and over again .

ID3 TAG

When playing a file containing information such as track files, you can see the information : Song, Album, Artist, Comment, Genre .

AUX OPERATION

On the front panel of this main unit, there is a AUX IN socket, following the diagram below, to connect analogue replay devices. Use this jack to replay sound of other replay equipment such as DVD players, computers, etc. Via the loudspeakers.

- 1). Please connect the external device with stereo jack plug the AUX IN socket.
- 2). Press the MOD button to select the AUX IN connection.
- 3). Use the VOL+/- button you can change the volume level.

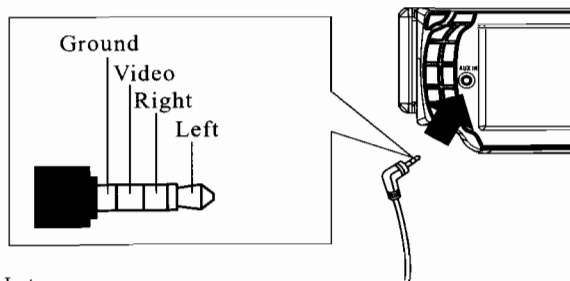

Note :

For more details operation, please refer to see page 18 .

USB/SD Card Reader Operation

USB Connexion

On the front panel of this player, there is an USB line port, if you would like to play back data contained on a USB stick, please following the diagram below, connect the stick into the opening provided. You can use the supplied adapter cable for this. If it is properly connected, the device will be mounted and start playing automatically.

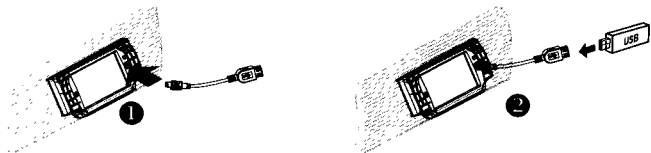

you can also select the desired item of the USB device. The buttons on the remote control, on the device, have the same functions as the touch buttons of this touch screen have.

In USB Playback mode

Use the UP, DOWN, RIGHT or LEFT buttons to navigate to and select files to play, and press ENTER to begin playback (or viewing, in the case of JPEG files). To skip to the next or last track, touch or press the ►► or ◀◀. Press the ►► or ◀◀ buttons for Fast Forward or Fast Reverse playback.

REPEAT play modes are also available by repeatedly pushing **REPEAT** until the desired mode is found.

Changing From USB to DISC

If you wish to begin playback of a disc already in the player, touch the ■ section on the touch screen or press the STOP on the remote once. Then touch GOTO range on the screen or press the GOTO on the remote and the player will switch to DVD/VCD/CD/MP3 Playback mode.

Changing From DISC to USB

If the disc present in the player is an MP3 disc, touch ■ section on screen or press the STOP on remote once then touch or press the GOTO to USB playback. If the disc present in the player is an DVD or VCD or CD disc, touch ■ on the screen or press STOP twice on the remote then touch GOTO section on the screen or press the GOTO button on the remote to USB playback.

Note:

To prevent damage to the USB device, do not remove or disconnect it during playback. It is also a good practice to remove the USB drive during disc playback.

SD Card Reader Operation

Following the diagram below (1-4 steps), connect your SD card reader device to front panel USB port. If it is properly connected, the device will be mounted and start playing automatically. (The method of operation as same as the USB operation.)

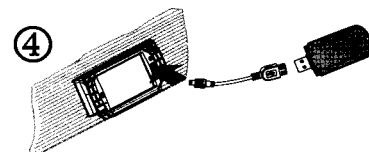
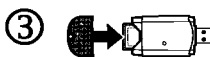

Trouble Shooting

Symptom	Cause	Correction
No power	The car ignition switch is not on	If the power supply is properly connected to the car accessory terminal, switch the ignition key to "ACC"
	The fuse is blown	Replace the fuse
Disc can not be loaded or ejected	Presence of disc inside the player.	Remove the disc in the player, then put a new one
	The disc is extremely dirty or defective	Clean the disc or try to play a new one
	Temperature inside the car is too high	Cool off or until the ambient temperature return to normal
Television/video image appears black-white	The color system is set incorrectly	Please switch to correct color system from menu
No television/video image appears	The unit is not connected to the parking brake detection switch	Make proper connection according to "wire connection"
	The parking brake is not engaged	For safety reasons no television/video images are displayed while the vehicle is moving. Engaging the parking brake will cause images to be displayed.
The radio does not work	The antenna cable is not connected	Insert the antenna cable firmly
	The signals are too weak	Select a station manually

Specification

General

Supply Voltage: 12V DC(11V-15V)

Current Consumption : Less than 10 A

Signal System: Compositive video 1.0Vp-75 Ω

Power Output : 40W X 4

Audio Output Level : 2ch &4ch line out

Audio Signal Output :

1. Frequency Response 20Hz-20KHz
2. S/N Ratio 90dB (JIS)
3. Wow and Flutter Below measurable limits

Discs Played:

1. DVD-VIDEO DISC
5" (12cm) single-sided, single-layer
5" (12cm) single-sided, double-layer
2. Compact Disc (CD-A, VIDEO CD)
5" (12cm) disc

Radio Section:

FM Tuner

Frequency Coverage : 87.5-108 MHz (For 2 Bands Europe)
87.5-107.9 MHz (For 2 Bands U.S.A.)

IF: 10.7MHz
Sensitivity (S/N=20 dB) : 40dBu

AM(MW) Tuner

Frequency Coverage : 522-1620 KHz (For 2 Bands Europe)
530-1710 KHz (For 2 Bands U.S.A.)

IF: 450KHz
Sensitivity (S/N=20dB) : 45dBu

TFT Monitor Section

Screen Size: 4.3 -inch wide type

Pixels: 1440 X 272

Color System: NTSC/PAL

Note: Specifications and design are subject to change without notice for further improvement .

888-J4319-02S