

Mini Hi-Fi Component System

Operating Instructions

Owner's Record

The model and serial numbers are located on the rear of the unit. Record the serial number in the space provided below. Refer to them whenever you call upon your Sony dealer regarding this product.

Model No. _____ Serial No. _____



MHC-GNX100

MHC-GNX90

MHC-GNX88/GNX80

MHC-GNX77/GNX70/GX9900

MHC-GNX66/GNX60

WARNING

To prevent fire or shock hazard, do not expose the unit to rain or moisture.

To avoid electrical shock, do not open the cabinet.

Refer servicing to qualified personnel only.

To prevent fire, do not cover the ventilation of the apparatus with newspapers, table-cloths, curtains, etc.

And don't place lighted candles on the apparatus.

To prevent fire or shock hazard, do not place objects filled with liquids, such as vases, on the apparatus.

Do not install the appliance in a confined space, such as a bookcase or built-in cabinet.

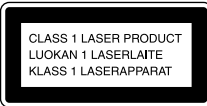

This appliance is classified as a CLASS 1 LASER product. This label is located on the rear exterior.



Don't throw away the battery with general house waste, dispose of it correctly as chemical waste.

NOTICE FOR THE CUSTOMERS IN THE U.S.A.

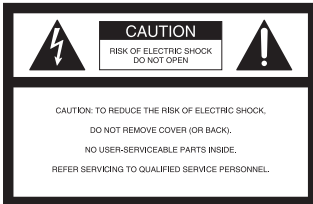

This symbol is intended to alert the user to the presence of uninsulated "dangerous voltage" within the product's enclosure that may be of sufficient magnitude to constitute a risk of electric shock to persons.



This symbol is intended to alert the user to the presence of important operating and maintenance (servicing) instructions in the literature accompanying the appliance.

WARNING

This equipment has been tested and found to comply with the limits for a Class B digital device, pursuant to Part 15 of the FCC Rules. These limits are designed to provide reasonable protection against harmful interference in a residential installation. This equipment generates, uses, and can radiate radio frequency energy and, if not installed and used in accordance with the instructions, may cause harmful interference to radio communications. However, there is no guarantee that interference will not occur in a particular installation. If this equipment does cause harmful interference to radio or television reception, which can be determined by turning the equipment off and on, the user is encouraged to try to correct the interference by one or more of the following measures:

- Reorient or relocate the receiving antenna.
- Increase the separation between the equipment and receiver.
- Connect the equipment into an outlet on a circuit different from that to which the receiver is connected.
- Consult the dealer or an experienced radio/TV technician for help.

CAUTION

You are cautioned that any changes or modification not expressly approved in this manual could void your authority to operate this equipment.

Note to CATV system installer:

This reminder is provided to call CATV system installer's attention to Article 820-40 of the NEC that provides guidelines for proper grounding and, in particular, specifies that the cable ground shall be connected to the grounding system of the building, as close to the point of cable entry as practical.

CAUTION

The use of optical instruments with this product will increase eye hazard.



ENERGY STAR® is a U.S. registered mark. As an ENERGY STAR® partner, Sony Corporation has determined that this product meets the ENERGY STAR® guidelines for energy efficiency.

Table of Contents

About this manual	5
Playable discs.....	6

Getting Started

Hooking up the system.....	8
Positioning the speakers.....	12
Setting the clock.....	13

Disc – Playback

Loading a disc	14
Playing a disc	14
— Normal Play/Shuffle Play	
Playing repeatedly	17
— Repeat Play	
Creating your own program	17
— Program Play	

Tuner

Presetting radio stations	19
Listening to the radio	21
— Preset Tuning	
— Manual Tuning	

Tape – Playback

Loading a tape.....	22
Playing a tape.....	22

Tape – Recording

Recording your favorite tracks on a disc into a tape	24
— CD Synchro Recording	
— Program Edit	
Recording on a tape manually.....	25
— Manual Recording	

Sound Adjustment

Adjusting the sound	26
Selecting the preset effect.....	26
Adjusting the graphic equalizer or selecting the surround effect	27
Selecting the MP3 Booster effect	28
Selecting the sound system.....	28
(MHC-GNX88/GNX80/GNX77/ GNX70/GX9900 only)	
Using the subwoofer.....	29
(MHC-GNX100/GNX88/GNX80 only)	
Flashing sound effect.....	29
— SOUND FLASH	
Creating a party environment	30
(MHC-GNX100 only)	
Selecting the speaker system	31
(MHC-GNX100 only)	
Selecting audio channel	31
— Multiplex Effect (MHC-GNX88/GNX77/ GNX66 only)	
Singing along.....	32

Timer

Falling asleep to music	33
— Sleep Timer	
Waking up to music.....	33
— Play Timer	
Timer recording radio programs.....	35

Display

Turning off the display.....	36
— Power Saving Mode	
Changing the spectrum analyzer display.....	37
Adjusting the brightness of the display.....	37
Changing the power illuminator	38
Viewing information about the disc in the display.....	38

Optional Components

Hooking up optional components	40
Listening to audio from a connected component	41
Recording on a connected component ..	41
(For MHC-GNX100/GNX90/ GNX88/GNX80/GNX77/ GNX70/GNX66/GNX60)	
Connecting external antennas	42

Troubleshooting

Problems and remedies	43
Messages	46

Additional Information

Precautions	48
Specifications	49
List of button locations and reference pages	54

About this manual

- The instructions in this manual are for models MHC-GNX100, MHC-GNX90, MHC-GNX88, MHC-GNX80, MHC-GNX77, MHC-GNX70, MHC-GX9900, MHC-GNX66 and MHC-GNX60. In this manual, the MHC-GNX88 is used for illustration purposes unless stated otherwise.

The MHC-GNX60 consists of:

- Tuner/CD/MP3 player/
Stereo cassette deck/
Amplifier (main unit) HCD-GNX60
- Speaker system
 - Front speakers SS-GNX60

The MHC-GNX66 consists of:

- Tuner/CD/CDG/MP3 player/
Stereo cassette deck/
Amplifier (main unit) HCD-GNX66
- Speaker system
 - Front speakers SS-GNX66

The MHC-GNX70/GX9900 consists of:

- Tuner/CD/MP3 player/
Stereo cassette deck/
Amplifier (main unit) HCD-GNX70/
GX9900
- Speaker system
 - Front speakers SS-GNX100
 - Surround speakers SS-RSX80

The MHC-GNX77 consists of:

- Tuner/CD/CDG/MP3 player/
Stereo cassette deck/
Amplifier (main unit) HCD-GNX77
- Speaker system
 - Front speakers SS-GNX88
 - Surround speakers SS-RSX80

The MHC-GNX80 consists of:

- Tuner/CD/MP3 player/
Stereo cassette deck/
Amplifier (main unit) HCD-GNX80
- Speaker system
 - Front speakers SS-GNX100
 - Surround speakers SS-RSX80
 - Subwoofer SS-WG80

The MHC-GNX88 consists of:

- Tuner/CD/CDG/MP3 player/
Stereo cassette deck/
Amplifier (main unit) HCD-GNX88
- Speaker system
 - Front speakers SS-GNX88
 - Surround speakers SS-RSX80
 - Subwoofer SS-WGV88

The MHC-GNX90 consists of:

- Tuner/CD/MP3 player/
Stereo cassette deck/
Amplifier (main unit) HCD-GNX90
- Speaker system
 - Front speakers SS-GNX90





The MHC-GNX100 consists of:

- Tuner/CD/MP3 player/
Stereo cassette deck/
Amplifier (main unit) HCD-GNX100
- Speaker system
 - Front speakers SS-GNX100
 - Surround speakers SS-RSX100
 - Subwoofer SS-WG100
- This manual mainly explains operations using the buttons on the unit, but the same operations can also be performed using the buttons on the remote having the same or similar names or symbols.

Playable discs

You can play back the following discs on this system. Other discs cannot be played back.

List of playable discs

Format of discs	Disc logo	Contents
Audio CDs		Audio
CD-R/CD-RW (Audio CDs/ CD Graphics (CDG)*/Discs with MP3 audio tracks)	 	Audio
CD Graphics (CDG)*		Audio + Video

* MHC-GNX88/GNX77/GNX66 only

Discs that this system cannot play back

- CD-ROMs other than those has MP3 audio tracks that conforms to ISO 9660^{a)} Level 1, Level 2, Joliet in expansion format.
- CD-Rs/CD-RWs other than those recorded in the following formats:
 - audio CD format
 - MP3 audio track format that conforms to ISO 9660^{a)} Level 1, Level 2, Joliet in expansion format or Multi Session^{b)}.
- Data part of CD-Extras^{c)}.
- Data part of Mixed CDs^{d)}.
- A disc that has a non-standard shape (e.g., card, heart).
- A disc with paper or stickers on it.
- A disc that has the adhesive, cellophane tape, or a sticker still left on it.
- Audio side of a DualDisc.

^{a)} ISO 9660 Format

The most common international standard for the logical format of files and folders on a CD-ROM. There are several specification levels. In Level 1, file names must be in the 8.3 format (no more than eight characters in the name, no more than three characters in the extension “.MP3”) and in capital letters. Folder names can be no longer than eight characters. There can be no more than eight nested folder levels. Level 2 specifications allow file names and folder names up to 31 characters long. Each folder can have up to 8 trees.

^{b)} Multi Session

This is a recording method that enables adding of data using the Track-At-Once method. Conventional discs begin at a disc control area called the Lead-in and end at an area called Lead-out. A Multi Session disc is a disc having multiple sessions, with each segment from Lead-in to Lead-out regarded as a single session.

^{c)} CD-Extra

This format records audio (audio CD data) on the tracks in session 1 and data on the tracks in session 2.

^{d)} Mixed CD

This format records data on the first track and audio (audio CD data) on the second and subsequent tracks of a session.

Notes on discs

- This system can play back CD-R/CD-RW discs edited by the user. However, note that playback of some discs may not be possible depending on the recording device used for recording or the disc condition.
- Discs recorded on CD-R/CD-RW drives may not be played back because of scratches, dirt, recording condition or the driver's characteristics.
- CD-R and CD-RW discs that have not been correctly finalized (processing to allow play back by a normal CD player) cannot be played back.
- CD-R and CD-RW discs recorded in multi-session that have not ended by "closing the session" are not supported.
- The system may be unable to play back MP3 format files that do not have the extension ".MP3".
- Attempting to play back non-MP3 format files that have the extension ".MP3" may result in noise or malfunction.
- The system can play back to a depth of 8 folders only.
- With formats other than ISO 9660 level 1, level 2 or Joliet in expansion format, folder names or file names may not be displayed correctly.
- The following discs take a longer time to start playback.
 - a disc recorded with complicated tree structure.
 - a disc recorded in Multi Session.
 - a disc to which data can be added (non-finalized disc).
- A disc recorded in packet write format cannot be played back.

Note on DualDiscs

This product is designed to play back discs that conform to the Compact Disc (CD) standard. A DualDisc is a two sided disc product which mates DVD recorded material on one side with digital audio material on the other side. Please be aware that the audio side of a DualDisc may not be played back on this product because these discs do not conform to the CD standard. "DualDisc" is a trademark of the Recording Industry Association of America (RIAA).

Music discs encoded with copyright protection technologies

This product is designed to play back discs that conform to the Compact Disc (CD) standard. Recently, various music discs encoded with copyright protection technologies are marketed by some record companies. Please be aware that among those discs, there are some that do not conform to the CD standard and may not be playable by this product.

Cautions when playing a disc that is recorded in Multi Session

- This system can play back Multi Session discs when an MP3 audio track is contained in the first session. Any subsequent MP3 audio tracks recorded in later sessions can also be played back.
- When you play back Multi Session discs with different formats for each session, the format of the first session is recognized as the disc type. Tracks in the second and subsequent sessions are played back if they are the same formats as the first session.

Getting Started

Hooking up the system

Do the following procedures **1** to **7** to hook up your system using the supplied cords and accessories (page 53).

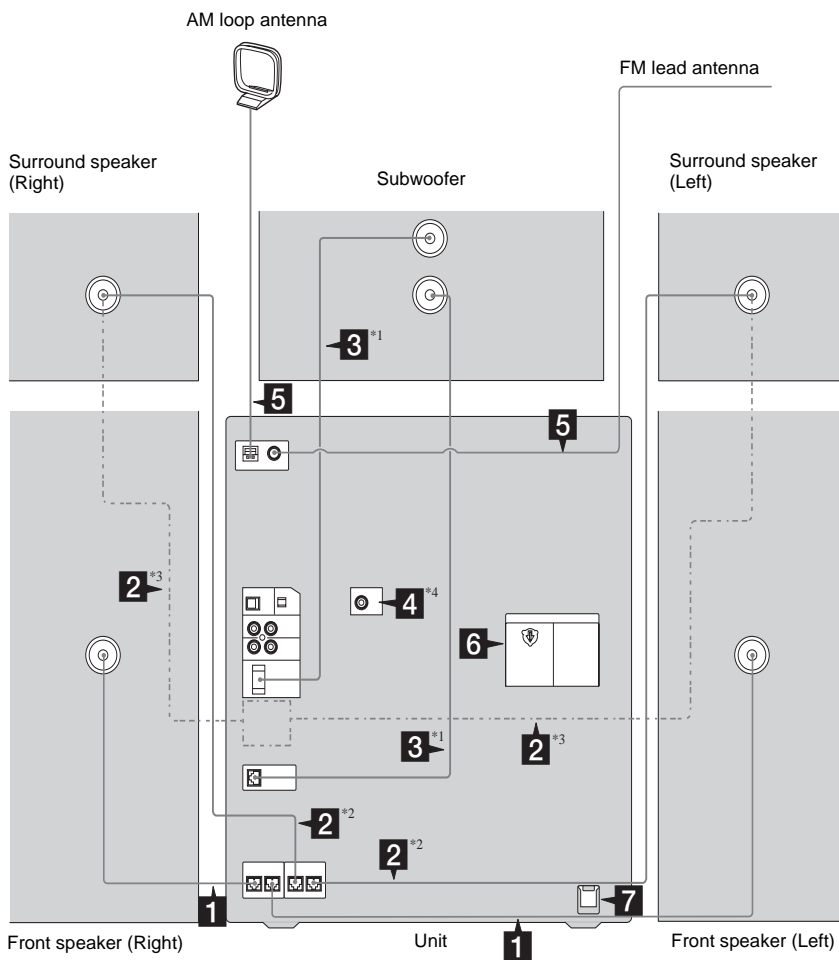

*1 MHC-GNX100/GNX88/GNX80 only

*2 MHC-GNX88/GNX80/GNX77/GNX70/GX9900 only

*3 MHC-GNX100 only

*4 MHC-GNX88/GNX77/GNX66 only

1 Connect the front speakers.

Connect the speaker cords of the front speakers to the FRONT SPEAKER terminals as shown below.

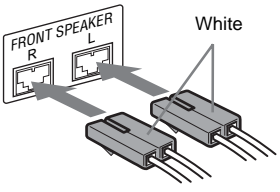

Tip

(MHC-GNX90 (SS-GNX90) only)
Connect the speaker cords to the terminals on the speakers.

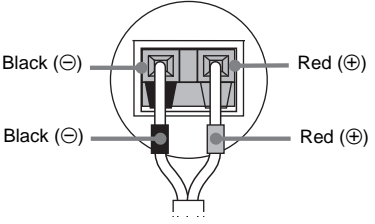

2 Connect the surround speakers.

Connect the speaker cords of the surround speakers to the SURR SPEAKER terminals as shown below.
MHC-GNX100 only

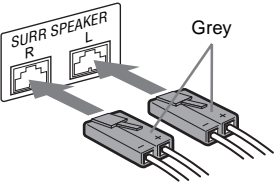

MHC-GNX88/GNX80/GNX77/GNX70/
GX9900 only

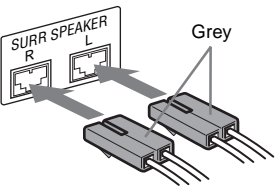

3 Connect the subwoofer. (MHC-GNX100/GNX88/GNX80 only)

Connect the subwoofer cord of the subwoofer to the SUBWOOFER OUT terminal and the system cord to the SYSTEM CONTROL jack as shown below.

SUBWOOFER OUT terminal

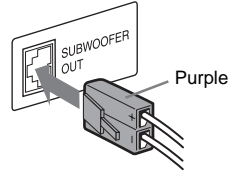

SYSTEM CONTROL jack

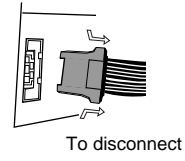

Note

Be sure to make this connection before you connect the unit's power cord to a wall outlet.

4 Connect the video input jack of your TV to the VIDEO OUT jack with the supplied video cord. (MHC-GNX88/GNX77/GNX66 only)



When using a TV

Turn on the TV and select the video input so that you can view the pictures from this system.

5 Connect the FM and AM antennas.

Set up the AM loop antenna, then connect it.

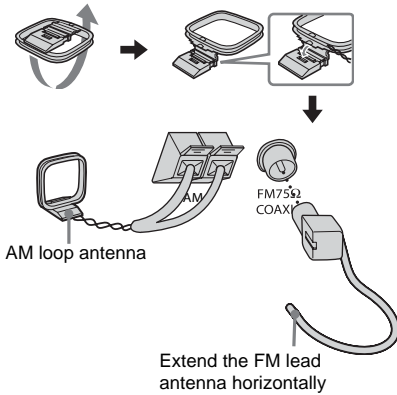

6 For models equipped with a voltage selector, set VOLTAGE SELECTOR to the position of your local power line voltage.

Brazil model only

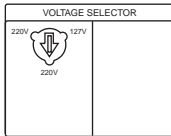

Other models

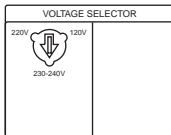

7 Connect the power cord to a wall outlet.

The demonstration appears in the display. When you press I/⏻, the system turns on and the demonstration automatically ends. If the supplied adaptor on the plug does not fit your wall outlet, detach it from the plug (only for models equipped with an adaptor).

Notes

- Keep the speaker cords away from the antennas to prevent noise.
- (Except for MHC-GNX90/GNX66/GNX60) Be sure to connect both left and right surround speakers.
- Be sure to match the color of the speaker terminals on the unit and the connectors.
- Be sure to connect the speakers securely and correctly. When connecting speaker cords, insert the connectors straight into the terminals.

To connect optional components

See “Hooking up optional components” on page 40.

Inserting two R6 (size AA) batteries into the remote

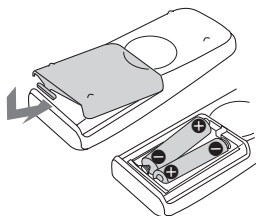

Note

If you do not use the remote for a long period of time, remove the batteries to avoid possible damage from battery leakage and corrosion.

Tip

With normal use, the batteries should last for about six months. When the remote no longer operates the system, replace both batteries with new ones.

Attaching the speaker pads

Attach the supplied speaker pads to the bottom of the speakers to stabilize the speakers and prevent them from slipping.

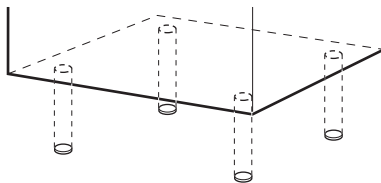

When carrying this unit

Do the following procedure to protect the disc mechanism.

Use buttons on the unit for the operation.

- 1** Press I/⏻ to turn on the system.
- 2** Press CD.
- 3** Make sure that all discs are removed from the unit.
- 4** Hold down CD, then press I/⏻ until "LOCK" appears in the display.
- 5** Release I/⏻ first, then release CD.
- 6** Unplug the AC power cord.

Positioning the speakers

For MHC-GNX90/GNX88/GNX80/GNX77/ GNX70/GNX66/GNX60/GX9900

Place the front speakers at an angle of 45 degrees from your listening position.

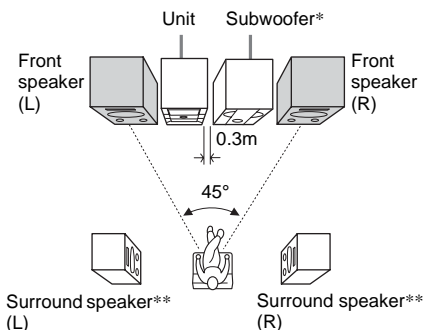

* MHC-GNX88/GNX80 only

** Except for MHC-GNX90/GNX66/GNX60

For MHC-GNX100

There are 2 different ways to place the speakers. We recommend you to place the subwoofer on solid floor where resonance is unlikely to occur so that a better bass reproduction could be obtained. To enjoy and to create a party environment, we recommend that you place your speakers as shown in Example 1.

Example 1

Place the speakers at an equal distance from your listening position as shown below.

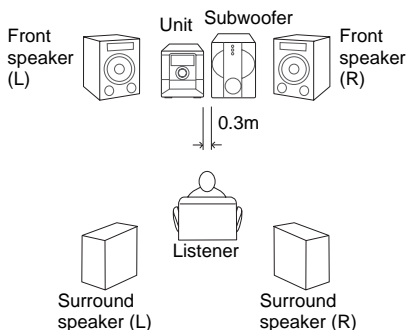

Example 2

Place the surround speakers beside the front speakers as shown below.

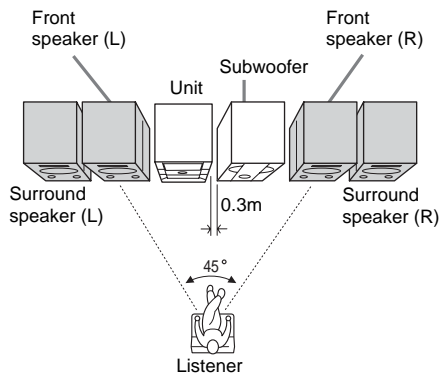

Note

(MHC-GNX100/GNX88/GNX80 only)

Place the subwoofer at least 0.3 meters (1 feet) away from the unit.

Setting the clock

Use buttons on the remote for the operation.

- 1 Press I/⏻ to turn on the system.**
- 2 Press CLOCK/TIMER SET.**
“CLOCK” appears in the display. Then, the hour indication flashes in the display.
- 3 Press -I◀◀ or ▶▶I+ repeatedly to set the hour.**
- 4 Press ENTER.**
The minute indication flashes in the display.
- 5 Press -I◀◀ or ▶▶I+ repeatedly to set the minute.**
- 6 Press ENTER.**
The clock starts functioning.

To adjust the clock

- 1 Press CLOCK/TIMER SET.**
“SET” appears in the display, then “PLAY SET?” flashes in the display.
- 2 Press -I◀◀ or ▶▶I+ repeatedly to select “CLOCK SET?”, then press ENTER.**
The hour indication flashes in the display.
- 3 Do the same procedures as step 3 to 6 above.**

Notes

- The clock settings are canceled when you disconnect the power cord or if a power failure occurs.
- You cannot set the clock in Power Saving Mode (page 36).

Disc – Playback

Loading a disc

- 1 Press ▲ OPEN/CLOSE.**
The disc tray slides out.
- 2 Load a disc with the label side facing up on the disc tray.**

When you play back a 8 cm disc such as CD single, place it on the inner circle of the tray

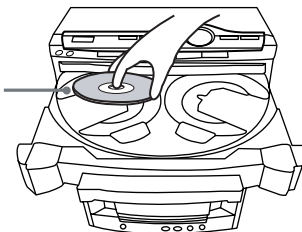

To load additional discs, press EX-CHANGE/DISC SKIP to rotate the disc tray.

- 3 Press ▲ OPEN/CLOSE to close the disc tray.**

Notes

- Do not push the disc tray when closing it as this may cause malfunction. Press ▲ OPEN/CLOSE to close the disc tray.
- Do not use a disc with tape, seals or paste on it as this may cause malfunction.

Playing a disc

— Normal Play/Shuffle Play

This system lets you play back CDGs*, audio CDs and discs with MP3 audio tracks in different play modes.

Before playing a CDG*, turn on your TV and select the video input.

* MHC-GNX88/GNX77/GNX66 only

When playing an audio CD

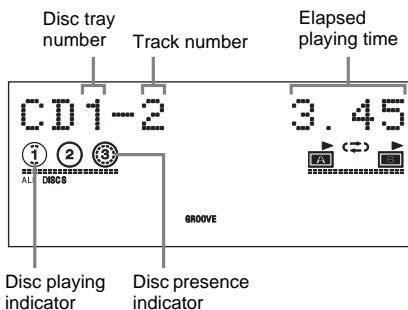

When playing an MP3 audio track

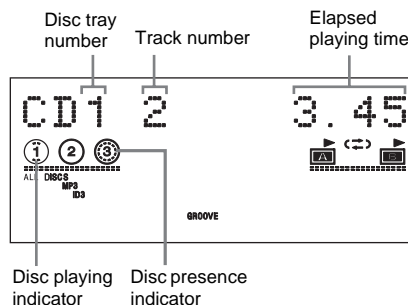

When playing a CDG (MHC-GNX88/GNX77/ GNX66 only)

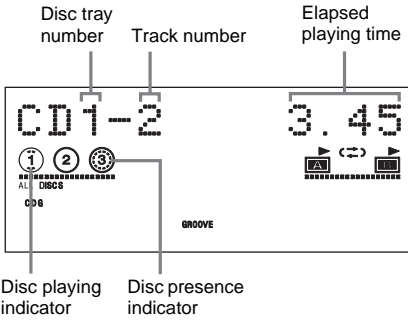

- 1 Press CD.**
- 2 When playback is stopped, press PLAY MODE on the remote repeatedly until the indication of the play mode you want lights up in the display.**

Select	To play back
ALL DISCS (Normal Play)	The tracks on all discs in the disc tray continuously.
1DISC (Normal Play)	The tracks on the disc you have selected in original order.
ALBM (Normal Play)	The MP3 audio tracks in the album on the disc you have selected in original order. For discs other than discs with MP3 audio tracks, "ALBM" play mode performs the same operation as "1DISC" play mode.

Select	To play back
ALL DISCS SHUF (Shuffle Play)	The tracks on all discs in random order.
1DISC SHUF (Shuffle Play)	The tracks on the disc you have selected in random order.
ALBM SHUF (Shuffle Play)	The MP3 audio tracks in the album on the disc you have selected in random order. For discs other than discs with MP3 audio tracks, "ALBM SHUF" play mode performs the same operation as "1DISC SHUF" play mode.
PROGRAM (Program Play)	The tracks on all discs in the order you want them to be played back (see "Creating your own program" on page 17).

- 3 Press ◀▶ (or ▶ on the remote).**

Other operations

To	Do this
Stop playback	Press ■.
Pause playback	Press ■■. Press ■■ again to resume playback.
Select a track	Turn ◀◀ ▶▶ clockwise or counterclockwise (or press ◀◀ or ▶▶+ on the remote repeatedly).
Select an album of MP3 audio tracks	Turn and hold ALBUM +/- clockwise or counterclockwise and release it at the album you want (or press ALBUM +/- on the remote repeatedly).
Find a point in a track ¹⁾²⁾	For audio CD, turn and hold ◀◀ ▶▶ clockwise or counterclockwise and release it at the point you want (or press ◀◀ or ▶▶ repeatedly on the remote). For MP3 audio track, press ◀◀ or ▶▶ repeatedly on the remote.
Select a disc when playback is stopped	Press one of the DISC 1 ~ 3 buttons or EX-CHANGE/DISC SKIP (or DISC SKIP on the remote).
Switch to CD function from another source and start playback automatically when there is a disc	Press one of the DISC 1 ~ 3 buttons (Automatic Source Selection).
Exchange other discs while playing	Press EX-CHANGE/DISC SKIP.
Remove a disc	Press ▲ OPEN/CLOSE.

¹⁾The elapsed playing time may not be displayed correctly depending on the MP3 audio tracks.

²⁾(MHC-GNX88/GNX77/GNX66 only)
You cannot find a point in a track when playing a CDG.

Notes

- You cannot change the play mode during playback.
- Some time may be needed to start playback of discs recorded in complex configurations such as many layers.
- When the disc is loaded, the system reads all the tracks on that disc. If there are many albums or non-MP3 audio tracks on the disc, it may take a longer time for playback to begin or for the next MP3 audio tracks to start playback.
- You are recommended not to save other types of tracks or unnecessary albums on a disc that has MP3 audio tracks.
- When naming the MP3 audio tracks, be sure to add the file extension “.MP3” to the file name.
- An album that does not include an MP3 audio track is skipped.
- If you save up the extension “.MP3” to a track other than MP3 audio tracks, the system cannot recognize the track properly and will generate a random noise which could damage your speaker.
- This system can play back MP3 audio tracks in the format of MPEG 1 Audio Layer 3, MPEG 2 Audio Layer 3 and MPEG 2.5 Audio Layer 3.
- The maximum number of albums on a disc which can be recognize by this system is 150 (including root album).
- The maximum number of MP3 audio tracks and albums on a disc which can be recognize by this system is 300.
- Depending on the encoding/writing software, recording device, or the recording media used at the time an MP3 audio track is recorded, you may encounter problems such as cannot play back, sound interruptions and noise.

Tips

- When you press CD or one of the DISC 1 ~ 3 buttons to switch to “CD” function from “TUNER” function, you may require a longer time to access the disc. In the case, set the CD power manage function to “CD POWER ON” (page 20).
- If you press CD while the system is turned off, the system turns on automatically and “CD” is selected as the function.
- You can also press FUNCTION on the remote repeatedly to select “CD”.
- (MHC-GNX88/GNX77/GNX66 only)
When you play back a CDG, some operation may cause image distortion on the video output.
- During Shuffle Play, some tracks may be played back repeatedly.

Playing repeatedly

— Repeat Play

You can play back all the tracks or a single track on a disc repeatedly.

Press REPEAT on the remote repeatedly during playback until “REPEAT” or “REPEAT1” lights up in the display.

REPEAT: All the tracks on the disc(s), or all the tracks in the album* are played back repeatedly up to five times.

REPEAT1: A single track is played back repeatedly until “REPEAT1” is cancelled.

* When “ALBM” or “ALBM SHUF” is selected for MP3 audio tracks.

To cancel Repeat Play

Press REPEAT repeatedly until both “REPEAT” and “REPEAT1” disappear from the display.

Note

You cannot select “REPEAT” and “ALL DISCS SHUF” at the same time.

Tip

You can change the Repeat Play setting when the playback is stopped.

Creating your own program

— Program Play

You can make a program of up to 25 steps from all the discs in the order you want to play back. You can synchro record the programmed tracks onto a tape (page 24).

- 1 Press CD.**
- 2 When playback is stopped, press PLAY MODE on the remote repeatedly until “PROGRAM” lights up in the display.**
- 3 Press one of DISC 1 ~ 3 buttons or EX-CHANGE/DISC SKIP (or DISC SKIP on the remote) to select a disc.**

To program all the tracks on a disc at once, proceed to step 5 while “AL” appears in the display.

To program all the MP3 audio tracks on an album at once, turn and hold ALBUM +/- clockwise or counterclockwise and release it at the album you want (or press ALBUM +/- on the remote repeatedly until the album you want appears in the display), then proceed to step 5.

4 Turn **◀▶▶▶** clockwise or counterclockwise (or press **-◀◀◀** or **▶▶▶+** on the remote repeatedly) until the track number you want appears in the display.

The total playing time flashes in the display. When programming an MP3 audio track, turn and hold **ALBUM +/-** clockwise or counterclockwise and release it at the album you want (or press **ALBUM +/-** on the remote repeatedly until the album you want appears in the display), then turn **◀◀◀▶▶▶** clockwise or counterclockwise (or press **-◀◀◀** or **▶▶▶+** on the remote repeatedly) until the track number you want appears in the display.

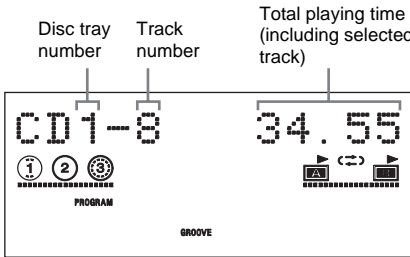

5 Press **ENTER**.

The track(s) is(are) programmed.

The program step number appears in the display.

6 To program additional discs or tracks.

To program	Repeat steps
Other discs	3 and 5
Other tracks on the same disc	4 and 5
Other tracks on other discs	3 to 5

7 Press **◀▶▶** (or **▶▶▶** on the remote).

Program Play starts.

Other operations

To	Do this
Cancel Program Play	When playback is stopped, press PLAY MODE on the remote repeatedly until "PROGRAM" disappear from the display.
Clear a track from the end of program	Press CLEAR on the remote when playback is stopped.

Tips

- The program you made remains in the system's memory even after it has been played back. Press **◀▶▶** (or **▶▶▶** on the remote) to play back the same program again.
- If "--.--" appears instead of the total playing time during programming, this means:
 - you have programmed a track number which exceeds 20.
 - the total playing time has exceeded 100 minutes.
 - you have programmed an MP3 audio track.

Tuner

Presetting radio stations

You can preset up to 20 FM stations and 10 AM stations. You can then tune in any of those stations simply by selecting the corresponding preset number.

Automatic tuning preset

You can automatically tune in all of the stations that can be received in your area and then store the frequency of your favourite stations.

- 1 Press TUNER/BAND repeatedly to select “FM” or “AM”.**
- 2 Press TUNING MODE on the remote repeatedly until “AUTO” lights up in the display.**
- 3 Turn TUNING +/- clockwise or counterclockwise (or press -|<<< or >>|+ on the remote).**

The frequency changes as the system scans for a station. Scanning stops automatically when a station is tuned in. “TUNED” lights up in the display. When a FM stereo program is tuned in, “STEREO” lights up in the display.

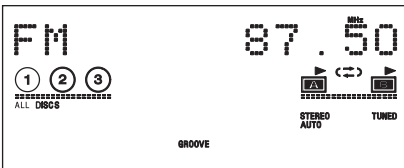

If “TUNED” does not lights up and the scanning does not stop

Set the frequency of the radio station you want as described in steps 2 and 3 of “Manual tuning preset”.

- 4 Press TUNER MEMORY on the remote.**

A preset number flashes in the display. The stations are stored from preset number 1.

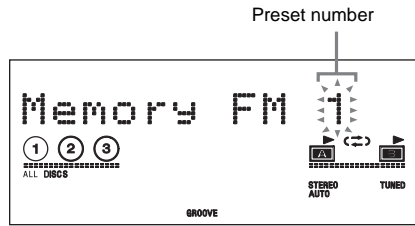

- 5 Turn TUNING +/- clockwise or counterclockwise (or press -|<<< or >>|+ on the remote repeatedly) to select the preset number you want.**

- 6 Press ENTER.**

“Complete!” appears in the display. The station is stored.

- 7 Repeat steps 1 to 6 to store other stations.**

Manual tuning preset

You can manually tune in and store the frequency of your favourite stations.

- 1 Press TUNER/BAND repeatedly to select “FM” or “AM”.**
- 2 Press TUNING MODE on the remote repeatedly until “MANUAL” lights up in the display.**
- 3 Turn TUNING +/- clockwise or counterclockwise (or press -|<<< or >>|+ on the remote repeatedly) to tune in the station you want.**

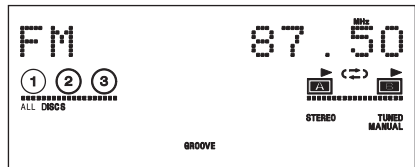

continued

4 Press TUNER MEMORY on the remote.

A preset number flashes in the display.
The stations are stored from preset number 1.

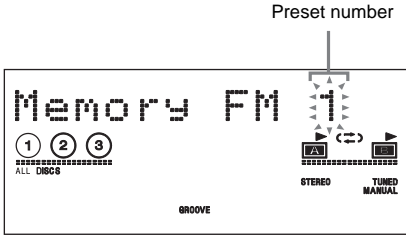

5 Turn TUNING +/- clockwise or counterclockwise (or press -|◀◀ or ▶▶+ on the remote repeatedly) to select the preset number you want.

6 Press ENTER.

“Complete!” appears in the display. The station is stored.

7 Repeat steps 1 to 6 to store other stations.

Other operations

To	Do this
Tune in a station with a weak signal	Follow the procedure described in “Manual tuning preset” on page 19.
Stop scanning during automatic tuning	Press ■.
Cancel presetting	Press TUNER MEMORY on the remote.

To improve tuner reception

When tuner reception is poor, set the CD power manage function to “CD POWER OFF”. The default setting is “CD POWER ON”.

Use buttons on the unit for the operation.

1 Press CD.

2 Press I/⏻ to turn off the system.

3 Press I/⏻ while holding ■.

The system turns on automatically. “CD POWER OFF” appears in the display.

To set to “CD POWER ON”

Repeat the procedure above and “CD POWER ON” appears in the display.

Notes

- When “CD POWER OFF” is selected, disc access time is increased.
- You cannot change the CD power manage function setting in the Power Saving Mode (page 36).

To change the AM tuning interval (except for Saudi Arabian models)

Use buttons on the unit for the operation.

The factory settings for AM tuning interval is 9 kHz (or 10 kHz for some areas). To change the AM tuning interval, select any AM station first, then turn off the system. While holding down ENTER, press I/⏻. The system turns on automatically and “AM 10k STEP” or “AM 9k STEP” appears in the display. When you change the interval, all the AM preset stations are erased. To reset the interval, repeat the same procedure.

Note

You cannot change the AM tuning interval in the Power Saving Mode (page 36).

Tips

- The preset stations are retained for half a day even if you unplug the power cord or if a power failure occurs.
- If you press TUNER/BAND while the system is turned off, the system turns on automatically and “TUNER” is selected as the function.
- You can also press FUNCTION on the remote repeatedly to select “TUNER”.

Listening to the radio

You can listen to a radio station either by selecting a preset station, or by manually tuning in the station.

Listening to a preset station

— Preset Tuning

Before tuning to preset stations, be sure to preset them (see “Presetting radio stations” on page 19).

- 1 Press **TUNER/BAND** repeatedly to select “FM” or “AM”.
- 2 Press **TUNING MODE** on the remote repeatedly until “PRESET” lights up in the display.
- 3 Turn **TUNING +/-** clockwise or counterclockwise (or press **-|<<<** or **>>>|+** on the remote repeatedly) to select the preset station you want.

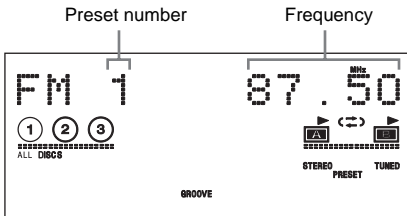

Listening to a non-preset radio station

— Manual Tuning

- 1 Press **TUNER/BAND** repeatedly to select “FM” or “AM”.
- 2 Press **TUNING MODE** on the remote repeatedly until “MANUAL” lights up in the display.
- 3 Turn **TUNING +/-** clockwise or counterclockwise (or press **-|<<<** or **>>>|+** on the remote repeatedly) to tune in the station you want.

Tips

- When an FM stereo program has static noise, press **FM MODE** on the remote repeatedly until “MONO” lights up in the display. There will be no stereo effect, but the reception will improve.
- To record the radio programs, see “Recording on a tape manually” (page 25) or “Timer recording radio programs” (page 35).
- You can also press **FUNCTION** on the remote repeatedly to select “TUNER”.
- To improve broadcast reception, adjust the supplied antennas, or connect an external antenna.

Tape – Playback

Loading a tape

- 1 Push **▶** (Deck A) or **◀** (Deck B) on the selected deck.

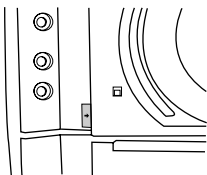

- 2 Load a tape into Deck A or B.

With the side you want to play back or record facing forward

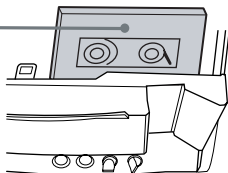

- 3 Push the center of the tape lid to close the deck.

Playing a tape

You can use TYPE I (normal) tape.

- 1 Load a tape.
- 2 Press **TAPE A/B** (or **TAPE** on the remote) repeatedly until “**TAPE A**” or “**TAPE B**” appears in the display.
- 3 Press **DIRECTION** repeatedly to select “**▶▶**” to play back one side, “**◀▶**”^{*1} to play back both sides or “**RELAY**”^{*2} (Relay Play) to play back both decks in succession.
- 4 Press **◀▶** (or **▶** on the remote).

The tape starts playing.

Press **◀▶** (or **▶** on the remote) again to play back the reverse side^{*3}.

Tape presence indicator

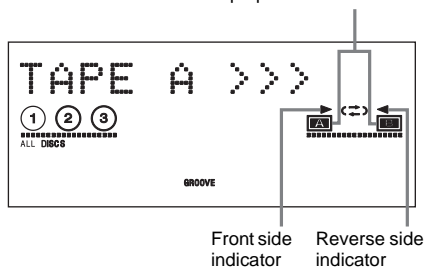

^{*1} Only for the tape in Deck B.

Playback stops automatically after repeating the sequence for five times.

^{*2} Relay Play follows this cyclic sequence up to five times, then stops:

Deck A (front side)



Deck B (front side)



Deck B (reverse side)

^{*3} You can only play back front side of the tape in Deck A.

Other operations

To	Do this
Stop playback	Press ■.
Pause playback	Press ■■. Press ■■ again to resume playback.
Fast-forward or rewind	Turn ◀▶▶ clockwise or counterclockwise (or press ◀◀ or ▶▶ on the remote). To back to normal playback, press ◀▶ (or ▶ on the remote).
Remove a tape	Push ▶ (Deck A) or ◀ (Deck B) when playback is stopped.

Note

Do not push ▶ (Deck A) or ◀ (Deck B) while playing a tape, otherwise the tape could be damaged.

Tips

- When a tape is inserted, corresponding presence indicator lights up in the display.
- If you press TAPE A/B (or TAPE on the remote) while the system is turned off, the system turns on automatically and “TAPE A” or “TAPE B” is selected as the function.
- If you press ◀▶ (or ▶ on the remote) during “TAPE A” function and there is no tape in Deck A, the system automatically switches to “TAPE B” function when there is a tape in Deck B. Then, playback will start and vice versa.
- You can also press FUNCTION on the remote repeatedly to select “TAPE A” or “TAPE B”.

Tape – Recording

Recording your favorite tracks on a disc into a tape



— CD Synchro Recording

You can record a whole disc into a tape. You can use TYPE I (normal) tape. The recording level is adjusted automatically.

- 1 Load a recordable tape into Deck B.**
- 2 Press CD and load a disc you want to record.**

When you want to record an album of MP3 audio tracks, press PLAY MODE on the remote repeatedly until “ALBM” lights up in the display. Then turn and hold ALBUM +/- clockwise or counterclockwise and release it at the album you want (or press ALBUM +/- on the remote repeatedly).

- 3 Press CD SYNC.**

“SYNC” lights up in the display.
“REC” flashes in the display.
Deck B standby for recording.
- 4 Press DIRECTION repeatedly to select “” to record on one side or “” (or “RELAY”) to record on both sides.**
- 5 Press REC PAUSE/START.**

“REC” lights up in the display.
Recording starts.

To stop recording

Press .

To record a disc by specifying track order





— Program Edit

You can record tracks on all the discs in the order you want using Program Play. Between steps 2 and step 3 of “CD Synchro Recording” (page 24), do steps 2 to 6 of “Creating your own program” (page 17). When programming, make sure the playing times for each side do not exceed the length of one side of the tape.

Note

You cannot listen to other sources while recording.

Tips

- For recording from the reverse side:
After step 1, press TAPE A/B (or TAPE on the remote) repeatedly until “TAPE B” appears in the display. Press  (or  on the remote) repeatedly until TAPE B reverse side indicator “” lights up in the display to start playback of the reverse side. Press  at the point you want to start recording.
- When you record on both sides, be sure to start from the front side. If you start from the reverse side, recording stops at the end of the reverse side.

Recording on a tape manually

— Manual Recording

You can record just the portions you like from a disc, tape or radio program on a tape.

You can also record from connected components (see “Hooking up optional components” on page 40).

- 1 Load a recordable tape into Deck B.**
- 2 Press CD, TAPE A/B, TUNER/BAND, TV or VIDEO/MD (or FUNCTION on the remote repeatedly) to select the source you want to record.**
- 3 Load the disc, tape or tune to the station you want to record. To record from the connected component, connect the external audio sources.**
- 4 Press REC PAUSE/START.**
“REC” flashes in the display.
Deck B standby for recording.
- 5 Press DIRECTION repeatedly to select “←” to record on one side or “↔” (or “RELAY”) to record on both sides.**
- 6 Press REC PAUSE/START.**
“REC” lights up in the display.
Recording starts.
- 7 Start playing the source to be recorded.**

To stop recording

Press ■.

Note

You cannot listen to other sources while recording.

Tips

- When you record on both sides, be sure to start from the front side. If you start from the reverse side, recording stops at the end of the reverse side.
- For recording from the radio:
If noise is heard while recording from the radio, move the respective antenna to reduce the noise.
- For recording from a disc to a tape manually:
You can turn ◀◀ ▶▶ clockwise or counterclockwise (or press ◀◀ or ▶▶+ on the remote repeatedly) to select tracks during recording pause (after step 4 and before step 6 of “Recording on a tape manually”).
- For recording from the reverse side:
After step 1, press TAPE A/B (or TAPE on the remote) repeatedly until “TAPE B” appears in the display. Press ◀▶ (or ▶ on the remote) repeatedly until TAPE B reverse side indicator “◀” lights up in the display to start playback of the reverse side. Press ■ at the point you want to start recording.
- For recording an album of MP3 audio tracks:
Press PLAY MODE on the remote repeatedly until “ALBM” lights up in the display. Then turn and hold ALBUM +/- clockwise or counterclockwise and release it at the album you want (or press ALBUM +/- on the remote repeatedly) after step 4 and before step 6 of “Recording to a tape manually”.
- When recording from the tape:
If you set the direction to “↔” (or “RELAY”) and the tapes you use have different lengths, the tapes in each deck reverses independently.

Sound Adjustment

Adjusting the sound

You can reinforce the bass and create a more powerful sound.

Press GROOVE repeatedly.

Each time you press the button, the display changes cyclically as follows:

GROOVE ON* → GROOVE OFF

* The volume switches to power mode and the equalizer curve changes.

Tips

- The default setting is “GROOVE ON”.
- When “GROOVE ON” is selected, “GROOVE” lights up in the display.

Selecting the preset effect

Turn OPERATION DIAL clockwise or counterclockwise (or press EQ on the remote repeatedly) to select the preset effect you want.

Preset effect options

Effect	Category
ROCK	Standard music sources
POP	
JAZZ	
DANCE	
SOUL	
TECHNO	
HIP HOP	
REGGAE	
SAMBA	
CLASSICAL	
FLAT	Original music source
USER EQ 1	User equalizer setting
USER EQ 2	
USER EQ 3	

To cancel the preset effect

Turn OPERATION DIAL clockwise or counterclockwise until “FLAT” appears in the display.

Adjusting the graphic equalizer or selecting the surround effect

You can adjust the sound by raising or lowering the level of specific frequency band, then store up to three user equalizer setting in the memory.

- 1** Press EQ BAND repeatedly to select a frequency band or surround effect.
- 2** Turn OPERATION DIAL clockwise or counterclockwise to adjust the level or select surround effect you want.

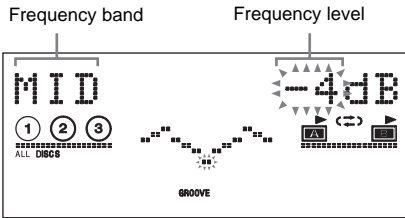

- 3** Repeat step 1 and 2 to adjust the level of other frequency bands.
- 4** Press ENTER.
A user equalizer number flashes in the display.
- 5** Turn OPERATION DIAL clockwise or counterclockwise to select a user equalizer number (1~3) you want to store the equalizer setting.
- 6** Press ENTER.

This setting is automatically stored as the user equalizer setting you selected in step 5. The previous setting stored at this memory location is erased and replaced by the new setting.

Tip

If you do not want to store the equalizer setting, select “EXIT?” in step 5.

Other operations

To	Do this
Call up a user equalizer setting	Turn OPERATION DIAL clockwise or counterclockwise until the user equalizer setting number you want appears in the display.

MHC-GNX100/GNX66/GNX60 only

Press SURROUND repeatedly.

Each time you press the button, the display changes cyclically as follows:

SURROUND ON → SURROUND OFF

Notes

- When you select certain preset effects, the surround effect may be canceled.
- When the surround effect is selected, “SURROUND” lights up in the display.

Selecting the MP3 Booster effect

You can improve the sound quality of MP3 audio tracks during playback.

Press MP3 BOOSTER repeatedly.

Each time you press the button, the display changes cyclically as follows:

BOOSTER ON → BOOSTER OFF

Tips

- The default setting is “BOOSTER ON”.
- When “BOOSTER ON” is selected, “MP3 BOOSTER” lights up in the display.
- MP3 Booster setting only can be changed when disc with MP3 audio tracks is selected during “CD” function.

Selecting the sound system

**(MHC-GNX88/GNX80/GNX77/GNX70/
GX9900 only)**

You can enjoy different sounds by selecting the sound mode you want.

MHC-GNX88/GNX80 only

Press SURR SPEAKER MODE on the unit or the subwoofer repeatedly to select the sound mode you want.

Each time you press the button, the indicator on the subwoofer and the display changes cyclically as follows:

LINK¹⁾ → MATRIX SURR 1²⁾ →
MATRIX SURR 2³⁾

Note

When you turn on the system, the last selected SURROUND SPEAKER MODE indicator on the subwoofer lights up.

MHC-GNX77/GNX70/GX9900 only

Press SURR SPEAKER MODE repeatedly to select the sound mode you want.

Each time you press the button, the display changes cyclically as follows:

LINK¹⁾ → MATRIX SURR²⁾

¹⁾ LINK : Reproduces the same sound with different output levels.

²⁾ MATRIX SURR/MATRIX SURR 1 : Reproduces a wide range of sound that can actually sense the size of the room.

³⁾ MATRIX SURR 2 : Reproduces a wide range of sound that can actually sense the size of the room. The surround sound is reinforced.

Using the subwoofer

(MHC-GNX100/GNX88/GNX80 only)

You can use the sound of the subwoofer to enhance the bass.

- 1 Press SUBWOOFER ON/OFF on the subwoofer repeatedly until the indicator lights up.**

The subwoofer is turned on.

- 2 Turn SUBWOOFER LEVEL to adjust the level.**

You will be able to listen to low bass frequency sound.

To turn off the subwoofer

Press SUBWOOFER ON/OFF on the subwoofer again.

Notes

- If you turn MASTER VOLUME (or press VOLUME +/- on the remote), the volume for all speakers will change.
- (MHC-GNX100 only)
When you select "SPEAKERS B", the subwoofer is turned off automatically.

Tip

You can turn MASTER VOLUME (or press VOLUME +/- on the remote) to adjust the volume of the subwoofer linked to the front speakers.

Flashing sound effect

— SOUND FLASH

With the sound flash function, you can flash the sound output. The sound cuts off periodically.

Hold down SOUND FLASH during playback.

The flashing effect is activated.

To cancel the flashing effect

Release SOUND FLASH.

To change the sound flash speed

Hold down SOUND FLASH and turn OPERATION DIAL clockwise or counterclockwise to change the sound flash speed (1 ~ 20).

Tips

- (MHC-GNX100 only)
You can activate the X-ROUND and SOUND FLASH effect simultaneously.
- The power illuminator will synchronize with the selected SOUND FLASH effect.

Creating a party environment

(MHC-GNX100 only)

You can create a party environment by using X-ROUND for “moving” sound effect or/and SOUND FLASH for flashing effect.

To enjoy the X-ROUND effect, place your front and surround speakers at an equal distance from your listening position (see “Positioning the speakers for MHC-GNX100” on page 12).

Moving sound effect

— X-ROUND

Press one of the X-ROUND buttons to select the X-ROUND mode you want.

The name of selected X-ROUND mode appears and the X-ROUND lights up in the display.

Tip

To change between AUTO WAVE and MANUAL WAVE, AUTO FADER and MANUAL FADER or AUTO BAL and MANUAL BAL, press AUTO/MANUAL repeatedly until the mode you want appears in the display.

Select	To output sound
AUTO WAVE ¹⁾ , MANUAL WAVE ²⁾	In circular motion
AUTO FADER ¹⁾ , MANUAL FADER ²⁾	From front speakers to surround speakers or vice versa
AUTO BAL ¹⁾ , MANUAL BAL ²⁾	From left speakers to right speakers or vice versa
RANDOM	In random position
TWISTER	In circular motion like “twister”

1) You can change the speed of sound movement by turning the X-ROUND JOG clockwise or counterclockwise.

2) You can manually change the sound movement from one speaker to another speaker by turning the X-ROUND JOG clockwise or counterclockwise.

To cancel the X-ROUND effect

Press X-ROUND OFF. “X-ROUND OFF” appears in the display.

Notes

- If you cannot get the sound effect you want, check the speaker connections.
- When the headphones are connected to the PHONES jack, X-ROUND mode automatically turned off and you cannot change the setting.

Selecting the speaker system

(MHC-GNX100 only)

You can select the speakers you want to turn on.

1 Press **SPEAKERS** on the unit or subwoofer.

Each time you press the button, the display and the indicators on the subwoofer changes cyclically as follows:

SPEAKERS A → SPEAKERS B →
SPEAKERS A+B

To select	Display
The front speakers	SPEAKERS A
The surround speakers	SPEAKERS B
Both the front and surround speakers	SPEAKERS A+B

Notes

- When X-ROUND mode is turned on, the speaker system automatically changes to SPEAKERS A+B.
- When the headphones are connected to the PHONES jack, you cannot change the speaker system.
- “SPEAKERS A” lights up in the display when SPEAKERS A is selected while “SPEAKERS B” lights up in the display when SPEAKERS B is selected.
- When you turn on the system, the last selected speaker system indicator on the subwoofer lights up.
- When you select “SPEAKERS B”, the subwoofer is turned off automatically.

Selecting audio channel

— Multiplex Effect

(MHC-GNX88/GNX77/GNX66 only)

When playing a multiplex audio CD or multiplex CDG (disc with the vocals on one channel and the instruments on the other channel), you can switch the sound to cancel the vocals and listen only to the instruments from both speakers.

1 Press **CD**.

2 Press **MPX** repeatedly.

Each time you press the button, the display changes cyclically as follows:

MPX L → MPX R → STEREO

Notes

- The “” lights up in the display when “MPX L” or “MPX R” is selected.
- If “MPX L” or “MPX R” is selected, the output from CD DIGITAL OUT jack will become monaural.
- When a disc with MP3 audio tracks is selected, you cannot select “MPX L” or “MPX R”.
- The multiplex setting is automatically changed to “STEREO” if the disc is changed or the function is changed.

Singing along

You can sing along with any stereo CD or tape. You need to connect an optional microphone.

- 1** Turn **MIC LEVEL** to “**MIN**” to turn down the microphone volume.
- 2** Connect an optional microphone to the **MIC 1** or **MIC 2** jack.
- 3** Start playing the music and adjust the volume.
- 4** Start singing along with the music and adjust the microphone volume by turning **MIC LEVEL**.

Other operations

To	Do this
Sing along with CDGs*	Turn on your TV and select the video input.
Adjust the microphone echo	Turn ECHO LEVEL to adjust the echo effect. To cancel the echo effect, turn ECHO LEVEL to “ MIN ”.

* MHC-GNX88/GNX77/GNX66 only.

Tips

- You can mix and record sound from microphone after step 2. To record the sound, see “Recording on a tape manually” on page 25. To stop recording, press ■.
- If acoustic feedback (howling) occurs, move the microphone away from the speakers or change the direction of the microphone.
- If you want to record your voice through the microphone only, you can do so by selecting the “**CD**” function and not playing a disc.
- When high level sound signals are input, the system automatically adjusts the recording level to prevent distortion of the recorded sound signal (Auto Level Control function).

Falling asleep to music

— Sleep Timer

You can set the system to turn off at a preset time, so that you can fall asleep to music. Use buttons on the remote for the operation.

Press SLEEP repeatedly.

Each time you press the button, the minute display (the turn-off time) changes cyclically as follows:

AUTO* → 90min → 80min → 70min
→ ... → 10min → OFF

* The system automatically turns off in 100 minutes or after the current disc or tape finishes playing.

Other operations

To	Do this
Check the remaining time**	Press SLEEP once.
Change the time to turn off	Press SLEEP repeatedly to select the time you want.
Cancel the Sleep Timer	Press SLEEP repeatedly until "SLEEP OFF" appears in the display.

** You cannot check the remaining time if you select "AUTO".

Notes

- During CD Synchro Recording, do not set the Sleep Timer to "AUTO".
- When the Sleep Timer is activated, "SLEEP" lights up in the display.

Tip

You can use the Sleep Timer, even if you have not set the clock.

Waking up to music

— Play Timer

You can wake up to music at a preset time. Make sure you have set the clock (see "Setting the clock" on page 13).

Use buttons on the remote for the operation.

1 Prepare the music source you want to play back.

- Disc: Load a disc. To start from a specific track, make a program (see "Creating your own program" on page 17).
- Tape: Load a tape with the side you want to play back facing forward.
- Radio: Tune in the preset station you want (see "Listening to the radio" on page 21).

2 Press VOLUME +/- to adjust the volume.

3 Press CLOCK/TIMER SET.

"SET" appears in the display, then "PLAY SET?" flashes in the display.

4 Press ENTER.

"ON" appears and the hour indication flashes in the display.

5 Set the time to start playback.

Press **◀◀◀** or **▶▶▶+** repeatedly (or turn **◀◀◀▶▶▶** on the unit clockwise or counterclockwise) to set the hour, then press ENTER.

The minute indication flashes in the display.

Press **◀◀◀** or **▶▶▶+** repeatedly (or turn **◀◀◀▶▶▶** on the unit clockwise or counterclockwise) to set the minute, then press ENTER.

6 Set the time to stop playback following the same procedure as step 5.

7 Press **◀◀◀** or **▶▶▶+** repeatedly (or turn **◀◀◀▶▶▶** on the unit clockwise or counterclockwise) until the music source you want appears in the display.

Each time you press the button, the display changes as follows:



8 Press **ENTER**.

The type of timer (“PLAY TIMER”), followed by the start time, the stop time and the music source appears in the display.

9 Press **I/⏻** to turn off the system.

Other operations

To	Do this
Check the setting	<ol style="list-style-type: none">1 Press CLOCK/TIMER SELECT. “SELECT” appears in the display.2 Press ◀◀◀ or ▶▶▶+ repeatedly (or turn ◀◀◀▶▶▶ on the unit clockwise or counterclockwise) to select “PLAY SELECT?”, then press ENTER.
Change the setting	Start from step 1.
Cancel the timer	<ol style="list-style-type: none">1 Press CLOCK/TIMER SELECT. “SELECT” appears in the display.2 Press ◀◀◀ or ▶▶▶+ repeatedly (or turn ◀◀◀▶▶▶ on the unit clockwise or counterclockwise) to select “TIMER OFF?”, then press ENTER.

Notes

- You cannot select the Play Timer and Timer Recording at the same time.
- If you use the Play Timer and the Sleep Timer at the same time, the Sleep Timer has priority.
- The Play Timer will not be activated if the system is turned on.

Tips

- The system turns on 15 seconds before the preset time.
- When the Play Timer is selected, “PLAY” lights up in the display.

Timer recording radio programs

You can record a preset radio station from a specified time.

To make a timer recording, you must first preset the radio station (see “Presetting radio stations” on page 19) and set the clock (see “Setting the clock” on page 13).

Use buttons on the remote for the operation.

1 Tune in the preset radio station (see “Listening to a preset station” on page 21).

2 Press CLOCK/TIMER SET.

“SET” appears in the display, then “PLAY SET?” flashes in the display.

3 Press $\blacktriangleleft\blacktriangleleft$ or $\blacktriangleright\blacktriangleright+$ repeatedly (or turn $\blacktriangleleft\blacktriangleleft\blacktriangleright\blacktriangleright$ on the unit clockwise or counterclockwise) to select “REC SET?”, then press ENTER.

“ON” appears and the hour indication flashes in the display.

4 Set the time to start recording.

Press $\blacktriangleleft\blacktriangleleft$ or $\blacktriangleright\blacktriangleright+$ repeatedly (or turn $\blacktriangleleft\blacktriangleleft\blacktriangleright\blacktriangleright$ on the unit clockwise or counterclockwise) to set the hour, then press ENTER.

The minute indication start flashes in the display.

Press $\blacktriangleleft\blacktriangleleft$ or $\blacktriangleright\blacktriangleright+$ repeatedly (or turn $\blacktriangleleft\blacktriangleleft\blacktriangleright\blacktriangleright$ on the unit clockwise or counterclockwise) to set the minute, then press ENTER.

5 Set the time to stop recording following the same procedure as step 4.

The type of timer (“REC”), followed by the start time, the stop time and the preset radio station to be recorded (e.g., “TUNER FM 5”) appears in the display.

6 Load a recordable tape into Deck B.

7 Press DIRECTION repeatedly on the unit to select “ \rightleftarrows ” to record on one side or “ \rightleftarrows ” (or “RELAY”) to record on both sides.

For recoding from the reverse side, press TAPE (or TAPE A/B on the unit) repeatedly until “TAPE B” appears in the display. Then, press \blacktriangleright (or \blacktriangleleft on the unit) repeatedly until TAPE B reverse side indicator “ \blacktriangleleft ” lights up in the display to start playback of reverse side. Press \blacksquare at the point where you want to start recording.

When you record on both sides, be sure to start from the front side. If you start from the reverse side, recording stops at the end of the reverse side.

8 Press I/OFF to turn off the system.

Other operations

To	Do this
Check the setting	<p>1 Press CLOCK/TIMER SELECT. “SELECT” appears in the display.</p> <p>2 Press $\blacktriangleleft\blacktriangleleft$ or $\blacktriangleright\blacktriangleright+$ repeatedly (or turn $\blacktriangleleft\blacktriangleleft\blacktriangleright\blacktriangleright$ on the unit clockwise or counterclockwise) to select “REC SELECT?”, then press ENTER.</p>
Change the setting	Start from step 1.
Cancel the timer	<p>1 Press CLOCK/TIMER SELECT. “SELECT” appears in the display.</p> <p>2 Press $\blacktriangleleft\blacktriangleleft$ or $\blacktriangleright\blacktriangleright+$ repeatedly (or turn $\blacktriangleleft\blacktriangleleft\blacktriangleright\blacktriangleright$ on the unit clockwise or counterclockwise) to select “TIMER OFF?”, then press ENTER.</p>

Notes

- You cannot select the Play Timer and Timer Recording at the same time.
- If you use the Timer Recording and the Sleep Timer at the same time, the Sleep Timer has priority.
- The Timer Recording will not be activated if the system is turned on.
- The volume is reduced to minimum during Timer Recording.
- Do not operate the system from the time the system turns on until the recording starts (about 15 seconds before the preset time).

Tips

- The system turns on 15 seconds before the preset time.
- When the Timer Recording is selected, “REC” lights up in the display.

Display

Turning off the display

— Power Saving Mode

The demonstration display and the clock display can be turned off to minimize the amount of power consumed during standby mode (Power Saving Mode).

Press DISPLAY repeatedly while the system is turned off until the demonstration display and the clock display disappears from the display.

To cancel Power Saving Mode

Press DISPLAY repeatedly while the system is turned off. Each time you press the button, the display changes cyclically as follows: Demonstration¹⁾ → Clock²⁾ → No display (Power Saving Mode)

¹⁾ The display changes and the indicators flashes even when the system is turned off.

²⁾ “--:--” appears in the display if you have not set the clock.

Note

You cannot do the following operations during Power Saving Mode:

- Setting the clock (page 13)
- Changing the AM tuning interval (page 20)
- Turning on the system by pressing the function buttons (CD, TAPE A/B, TUNER/BAND, TV or VIDEO/MD)
- Changing CD power manage setting (page 20)

Tips

- The timer continues to operate in Power Saving Mode.
- I/⏸ indicator lights up in red color even in the Power Saving Mode.

Changing the spectrum analyzer display

- 1** Press AMP MENU repeatedly to select "SPECTRUM".

The last selected spectrum setting appears in the display.

- 2** Turn OPERATION DIAL clockwise or counterclockwise to select the setting you want.

The display changes as follows:



- 3** Press ENTER.

When X-ROUND mode is selected (MHC-GNX100 only)

- 1** Press AMP MENU repeatedly to select "X-POSITION".

The last selected spectrum setting appears in the display.

- 2** Turn OPERATION DIAL clockwise or counterclockwise to select the setting you want.

The display changes as follows:

X-POS ON* ↔ X-POS OFF

*The spectrum analyzer display will synchronize with the selected X-ROUND effect.

- 3** Press ENTER.

Adjusting the brightness of the display

- 1** Press AMP MENU repeatedly to select "DIMMER".

The last selected dimmer setting appears in the display.

- 2** Turn OPERATION DIAL clockwise or counterclockwise to select the setting you want.

The display changes as follows:



* DIMMER 2 is the darkest.

- 3** Press ENTER.

Changing the power illuminator

Press **ILLUMINATION** repeatedly to select the power illuminator you want when the system is turned on.

Each time you press the button, the power illuminator changes cyclically as follows:

PATTERN 1 → PATTERN 2 →
PATTERN 3 → PATTERN 4 →
PATTERN OFF

Notes

- When you turn **MASTER VOLUME** (or press **VOLUME +/-** on the remote), power illuminator shows the current volume level.
- During the demonstration display, you can turn on or off power illuminator by pressing **ILLUMINATION**.

Viewing information about the disc in the display

You can check the elapsed playing time and remaining time of the current track or current disc.

When a **CD-TEXT** disc or a disc with **MP3** audio tracks is loaded, you can also check the information recorded on disc, such as the titles.

When the system detects **CD-TEXT** discs, “**CD TEXT**” lights up in the display.

Checking the elapsed playing time, remaining time and titles

Press **DISPLAY** repeatedly during playback.

Each time you press the button, the display changes cyclically as follows:

Elapsed playing time of the current track →
Remaining time of the current track¹⁾ →
Remaining time of the current disc²⁾ → Title of the current track³⁾ → Title of the current album (for a few seconds)⁴⁾ → Clock display⁵⁾ (for 8 seconds) → Effect status (for 8 seconds)

- 1) “--:--” appears while an **MP3** audio track is played back.
- 2) “--:--” appears in the following cases:
 - while an **MP3** audio track is played back.
 - All play modes except “**IDISC**” or “**ALBM**”.
- 3) Only for **CD-TEXT** discs and a discs with **MP3** audio tracks.
When the **CD-TEXT** disc contains more than 20 tracks, the title of current track is not displayed from track 21 onwards.
- 4) Only for discs with **MP3** audio tracks.
- 5) “--:--” appears in the display if you have not set the clock.

Checking the total playing time and titles

Press **DISPLAY** repeatedly when playback is stopped.

Each time you press the button, the display changes cyclically as follows:

■ When the play mode is other than “PROGRAM”

Total number of tracks¹⁾ or albums²⁾ or the total playing time³⁾ → Title of current disc⁴⁾ or current album¹⁾ → Clock display⁵⁾ (for 8 seconds) → Effect status (for 8 seconds)

- 1) For discs with MP3 audio tracks in “ALBM” and “ALBM SHUF” modes.
- 2) For discs with MP3 audio tracks in play modes other than “ALBM” and “ALBM SHUF”.
- 3) For audio CDs and CDGs*.
*MHC-GNX88/GNX77/GNX66 only
- 4) For discs with MP3 audio tracks in play modes other than “ALBM”, “ALBM SHUF” and CD-TEXT discs.
- 5) “--:--” appears in the display if you have not set the clock.

■ When the play mode is “PROGRAM”

The last track number of the program and the total playing time¹⁾ → Total number of programmed tracks (for 8 seconds)²⁾ → Title of current disc³⁾ → Clock display⁴⁾ (for 8 seconds) → Effect status (for 8 seconds)

- 1) “--:--” appears in the following cases:
 - When the audio CD contains 21 tracks or more, and the track number which exceeds 20 is selected.
 - When the total program exceeds 100 minutes.
 - When the program list contains MP3 audio tracks.
- 2) “NO STEP” appears in the display if there is no program.
- 3) Only for CD-TEXT discs and discs with MP3 audio tracks.
- 4) “--:--” appears in the display if you have not set the clock.

Note

Some characters may not be displayed for track title, album title or disc title.

Optional Components

Hooking up optional components

To enhance your system, you can connect optional components. Refer to the operating instructions provided with each component.

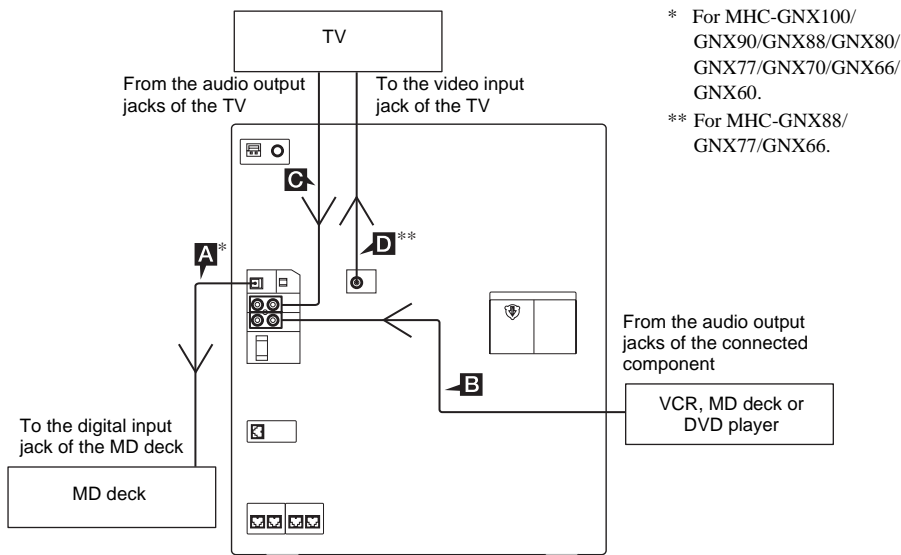

* For MHC-GNX100/
GNX90/GNX88/GNX80/
GNX77/GNX70/GNX66/
GNX60.

** For MHC-GNX88/
GNX77/GNX66.

A CD DIGITAL OUT jack (For MHC-GNX100/GNX90/GNX88/ GNX80/GNX77/GNX70/GNX66/ GNX60)

Use a digital optical cord (square, not supplied) to connect the digital input jack of the optional MD deck to this jack. You can then record digital audio from this system.

Notes

- There is no digital audio output from this jack during playback of an MP3 audio track.
- (For MHC-GNX88/GNX77/GNX66)
If “MPX L” or “MPX R” is selected, the digital audio output from this jack will become monaural.

B VIDEO/MD (AUDIO IN) L/R jacks

Use audio cords (not supplied) to connect the audio output jacks of the optional component (such as VCR or MD deck) to these jacks. You can then output audio through this system.

C TV (AUDIO IN) L/R jacks

Use audio cords (not supplied) to connect the audio output jacks of a TV to these jacks. You can then output audio signal through this system.

D VIDEO OUT jack (For MHC-GNX88/GNX77/GNX66)

Use a video cord (supplied) to connect the video input jack of a TV to this jack.

Listening to audio from a connected component

Listening to a connected VCR, MD deck or DVD player

- 1 Connect the audio cords.**
See “Hooking up optional components” on page 40.
- 2 Press VIDEO/MD.**
Start playing the connected component.

To switch between the “VIDEO” and “MD” function

Hold down VIDEO/MD and press I/⏻ while the system is turned on. Release I/⏻ first, then release VIDEO/MD. The system switches the function from “VIDEO” to “MD” or vice versa.

Note

If the sound is distorted or too loud when “VIDEO” is selected, change the function to “MD”.

Listening to a connected TV

- 1 Connect the audio cords.**
See “Hooking up optional components” on page 40.
- 2 Press TV.**

Tip

You can press FUNCTION on the remote repeatedly to select “VIDEO”, “MD” or “TV”.

Recording on a connected component

(For MHC-GNX100/GNX90/GNX88/GNX80/GNX77/GNX70/GNX66/GNX60)

Making a digital recording from a disc onto a connected MD deck

- 1 Connect an optical cord.**
See “Hooking up optional components” on page 40.
- 2 Start recording.**
Refer to the operating instructions provided with the connected component.

Notes

- When making a digital recording to MD deck, start the recording of MD deck in advance.
- You cannot record from an MP3 audio track digitally.

Connecting external antennas

Connect an external antenna to improve the reception.

FM antenna

Connect an optional FM external antenna. You can also use the TV antenna instead.

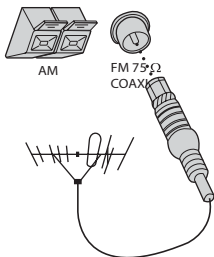

AM antenna

Connect a 6 to 15 meter (20 to 50 feet) insulated wire to the AM antenna terminal. Leave the supplied AM loop antenna connected.

Insulated wire
(not supplied)

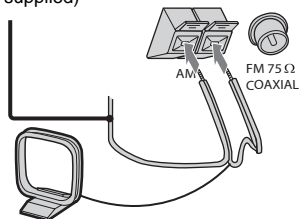

Troubleshooting

Problems and remedies

Should you encounter a problem with your system, do the following:

- 1 Make sure the power cord and speaker cords are connected correctly and firmly.
- 2 Find your problem in the troubleshooting checklist below and take the indicated corrective action.

If the problem persists after doing all of the above, consult your nearest Sony dealer.

When the I/⏻ indicator flashes

Immediately unplug the power cord and check the following items.

- (MHC-GNX100/GNX88/GNX80 only)
Is the system control cable connected correctly?
- If your unit have voltage selector, is the voltage selector set to the correct voltage? Check the voltage for your region, then make sure the voltage selector is set correctly.
- Are you using the supplied speakers?
- Is anything blocking the ventilation holes on the rear of the unit?

After checking the above items and fixing any problem, plug in the power cord again and turn on the system. If the I/⏻ indicator still flashing, or if the cause of the problem cannot be found even after checking all the above items, consult your nearest Sony dealer.

General

The display starts flashing as soon as you plug in the power cord even though you have not turned on the system.

- The demonstration mode started. Press I/⏻ (see step 7 of “Hooking up the system” on page 8).

The clock/timer setting is canceled.

- The power cord is disconnected or a power failure occurred. Redo “Setting the clock” (page 13). If you have set the timer, redo “Waking up to music” (page 33) and “Timer recording radio programs” (page 35).

The radio presetting is canceled.

- The power cord is disconnected or a power failure occurred for longer than half a day. Redo “Presetting radio stations” (page 19).

“- -: - -” appears in the display.

- A power failure occurred. Set the clock (page 13) and timer settings (page 33 to 36) again.

There is no sound.

- Turn MASTER VOLUME clockwise (or press VOLUME + on the remote).
- Make sure the headphones are not connected to the PHONES jack.
- Check the speaker connections (page 9).
- There is no audio output during Timer Recording.

There is no microphone sound.

- Turn MASTER VOLUME (or press VOLUME +/- on the remote repeatedly) or MIC LEVEL to adjust the microphone volume.
- Make sure the microphone is connected to the MIC 1 or MIC 2 jack correctly.

There is severe hum or noise.

- A TV or VCR is placed too close to the unit. Move the unit away from the TV or VCR.
- Move the unit away from the source of noise.
- Connect the unit to a different wall outlet.
- Install a noise filter (commercially available) to the power cord.

The timer cannot be set.

- Set the clock again (page 13).

The timer does not function.

- Check the timer setting and set the correct time (pages 33 to 36).
- Cancel the Sleep Timer function (page 33).
- You cannot select the Play Timer and Timer Recording simultaneously.

The remote does not function.

- Remove the obstacle between the remote and the unit.
- Move the remote closer to the unit.
- Point the remote at the unit's sensor.
- Replace the batteries (R6/size AA).
- Locate the unit away from the fluorescent light.

There is acoustic feedback.

- Decrease the volume.
- Move the microphone away from the speakers or change the direction of the microphone.

The color irregularity on a TV screen persists.

- Turn off the TV set once, then turn it on after 15 to 30 minutes. If the color irregularity still persists, place the speakers farther away from the TV set.

The sound from the component connected to the VIDEO/MD (AUDIO) IN jacks is distorted.

- If "VIDEO" appears in the display when you press VIDEO/MD, switch to "MD" function (see "To switch between the "VIDEO" and "MD" function" on page 41).

The subwoofer is turned off automatically.**

- You have selected "SPEAKERS B". Press SUBWOOFER ON/OFF on the subwoofer.

Speakers

Sound comes from one channel or unbalanced left and right volume.

- Place the speakers as symmetrically as possible.
- Check that the speakers are connected securely and correctly.
- Turn off the X-ROUND mode (page 30).**
- The source being played back is monaural.
- Press MPX repeatedly until "●" disappears from the display.*

Sound lacks bass.

- Check that the speaker's + and - terminals are connected correctly.

* MHC-GNX88/GNX77/GNX66 only

** MHC-GNX100 only

Disc player

The disc tray does not open and "LOCKED" appears in the display.

- Contact your nearest Sony dealer or local authorized Sony service facility.

The disc tray does not close.

- Load the disc correctly.
- Always close the tray by pressing ▲ OPEN/CLOSE. Trying to push the tray closed with your fingers may cause problems with the system.

The disc does not eject.

- You cannot eject the disc during CD Synchro Recording. Press ■ to cancel the CD Synchro Recording, then press ▲ OPEN/CLOSE to eject the disc.
- Consult your nearest Sony dealer.

Playback does not start.

- Open the disc tray and check whether a disc is loaded.
- Wipe the disc clean (page 48).
- Reload the disc.
- Load the disc that this system can play back (page 6).
- Load the disc correctly.
- Load the disc in the tray with the label side up.
- Remove the disc and wipe away the moisture on the disc, then leave the system turned on for a few hours until the moisture evaporates.
- Press ◀▶ (or ▶ on the remote) to start playback.

Disc access takes a longer time.

- Set CD power manage function to "CD POWER ON" (page 20).

The sound skips.

- Wipe the disc clean (page 48).
- Reload the disc.
- Try moving the system to a place without vibration (e.g., on top of a stable stand).
- Try moving the speakers away from the unit, or placing them on separate stands. When you listen to a track with bass sounds at high volume, the speaker vibration may cause the sound to skip.

Playback does not start from the first track.

- The system is in Program Play or Shuffle Play mode. Press PLAY MODE on the remote repeatedly until "ALL DISCS", "1 DISC" or "ALBM" lights up in the display.

MP3 audio track cannot be played back.

- Recording was not performed according to the ISO 9660 level 1, level 2 or Joliet in the expansion format.
- The MP3 audio track does not have the extension “.MP3”.
- The data is not stored in MP3 format even though it has extension “.MP3”.
- The MP3 audio tracks in format other than MPEG 1, 2 and 2.5 Audio Layer 3 cannot be played back.
- The system can play back to a depth of 8 folders only.
- MP3 audio tracks in MP3 PRO format cannot be played back on this system.

MP3 audio tracks take longer time to play back than others.

- After the system reads all tracks on the discs, playback may take more time than usual if:
 - the number of albums or tracks on the disc is very large.
 - the album and track organization structure is very complex.

The album title, track title, ID3 tag and the CD-TEXT characters do not appear properly.

- Use a disc that conforms with ISO 9660 level 1, level 2 or Joliet in the expansion format.
- The ID3 tag is not version 1 or version 2.
- The character code that can be displayed by this system are as follow:
 - Upper cases (A to Z)
 - Lower cases (a to z)
 - Numbers (0 to 9)
 - Symbols (<> * +, - / [] \ _)
 Other characters may not be displayed correctly.

The output from CD DIGITAL OUT jack is monaural.*

- Press MPX repeatedly until “” disappears from the display.

When you turn ◀▶ clockwise or counterclockwise (or press ◀ or ▶ on the remote), “Not in Use” flashes in the display.*

- The CDG is played back. This is not a malfunction.

* MHC-GNX88/GNX77/GNX66 only

Tuner

There is severe hum or noise. (“TUNED” or “STEREO” flashes in the display)

- Set the proper band and frequency (page 19).
- Connect the antenna properly (page 10).
- Find a place and an orientation that provide good reception, then set up the antenna again. If you cannot obtain good reception, we recommend you connect an external antenna.
- The supplied FM lead antenna receives signals along its entire length, so make sure you extend it fully.
- Locate the antennas as far away from the speaker cords as possible.
- Try turning off surrounding electrical equipment.
- Set CD power manage function to “CD POWER OFF” (page 20).

A stereo FM program cannot be received in stereo.

- Press FM MODE on the remote repeatedly until “MONO” disappears in the display.

Tape deck

The tape does not record or playback, or there is a decrease in sound level.

- The tape heads are dirty (see “Cleaning the tape heads” on page 49).
- The record/playback heads are magnetized (see “Demagnetizing the tape heads” on page 49).

The tape does not erase completely.

- The record/playback heads are magnetized (see “Demagnetizing the tape heads” on page 49).

There is excessive wow or flutter, or the sound drops out.

- The capstans or pinch rollers are dirty (see “Cleaning the tape heads” on page 49).

Noise increases or the high frequencies are erased.

- The record/playback heads are magnetized. (see “Demagnetizing the tape heads” on page 49).

The tape does not record.

- No tape is loaded. Load a tape.
- The tab has been removed from the tape. Cover the broken tab with adhesive tape (page 49).
- The tape has reeled to the end.

The system cannot play back the reverse side of the tape in Deck A.

- The system only can play back front side of the tape in Deck A. This is not a malfunction.

When you turn ◀◀ ▶▶ clockwise or counterclockwise (or press -◀◀ or ▶▶+ on the remote), "Not in Use" flashes in the display.

- The system does not has AMS (Automatic Music Sensor) function. This is not a malfunction.

If the system still does not operate properly after performing the above measures or other troubles does not described above occur, reset the system as follows:

Use buttons on the unit for the operation.

- 1 Unplug the power cord.
- 2 Plug the power cord back in.
- 3 Press I/⏻ to turn on the system.
- 4 Press ■, ENTER and I/⏻ at the same time.
The system is reset to the factory settings.
You should set the settings you made, such as the preset stations, clock and timer.

Messages

One of the following messages may appear or flash in the display during operation.

Disc

NO STEP

You have cleared all the steps you programmed.

OVER

You have reached the end of the disc while turning and holding ◀◀ ▶▶ clockwise (or pressing ▶▶ on the remote) during playback or pause.

No Disc

There is no disc on the disc tray.

Push STOP!

You have pressed PLAY MODE on the remote during playback.

Step Full!

You tried to program more than 25 steps.

Reading

The system is reading information of the disc. Some buttons are not available.

Tape

No Tab

You cannot record the tape because the tab has been removed from the tape.

No Tape

There is no tape in the tape deck.

Timer

OFF TIME NG!

The on time and off time of Play Timer or Timer Recording is same.

SET CLOCK!

You pressed CLOCK/TIMER SELECT before the clock is set.

SET TIMER!

You pressed CLOCK/TIMER SELECT before Play Timer or Timer Recording is set.

PUSH SELECT!

You tried to set the clock or timer during timer operation.

Others

Not in Use

You have pressed a button those operations is not allowed or invalid at that time.

Additional Information

Precautions

On operating voltage

Before operating the system, check that the operating voltage of your system is identical with the voltage of your local power supply.

On safety

- The system is not disconnected from the AC power source (mains) as long as it is connected to the wall outlet, even if the system itself has been turned off.
- Unplug the system from the wall outlet (mains) if it is not to be used for an extended period of time. To disconnect the power cord (mains lead), pull it out by the plug. Never pull the cord itself.
- Should any solid object or liquid fall into the system, unplug the system and have it checked by qualified personnel before operating it any further.
- For customers in United States
One blade of the plug is wider than other for the purpose of safety and will fit to the wall outlet only one way. If you are unable to insert the plug fully into the outlet, contact your dealer.
- AC power cord must be changed only at the qualified service shop.

On placement

- Do not place the system in an inclined position.
- Do not place the system in locations where it is;
 - Extremely hot or cold
 - Dusty or dirty
 - Very humid
 - Subject to vibrations
 - Subject to direct sunlight
- Use caution when placing the system or speakers on surfaces that have been specially treated (with wax, oil, polish, etc.) as staining or discoloration of the surface may result.

On heat build-up

- Although the system heats up during operation, this is not a malfunction.
- Place the system in a location with adequate ventilation to prevent heat build-up in the system.
- If you continuously use this system at a large volume, the cabinet temperature of the top, side and bottom rises considerably. To avoid burning yourself, do not touch the cabinet.
- To prevent a malfunction, do not cover the ventilation hole for the cooling fan.

On operation

- If the system is brought directly from a cold to a warm location, or is placed in a very damp room, moisture may condense on the lens inside the system. Should this occur, the system will not operate properly. Remove the disc and leave the system turned on for about an hour until the moisture evaporates.
- When you move the system, take out any disc.

If you have any questions or problems concerning your system, please consult your nearest Sony dealer.

Notes on discs

- Before playing, clean the disc with a cleaning cloth. Wipe the disc from the center out.
- Do not use solvents such as benzene, thinner, commercially available cleaners or anti-static spray intended for vinyl LPs.
- Do not expose the disc to direct sunlight or heat sources such as hot air ducts nor leave it in a car parked in direct sunlight.
- Do not use discs encircled with a protection ring. This may cause a malfunction to the system.
- When using discs that have glue or similar tacky substance on the label side of the disc or that used a special ink when the label was printed, there is a chance that the disc or label may become attached to parts inside this system. When this occurs, it may not be possible to remove the disc, and may also cause this system to malfunction. Be sure to check that the label side of the disc is not sticky before using.
The following types of disc should not be used:
 - Rental or used discs with attached seals where the glue extends beyond the seal. The perimeter of the seal on the disc is tacky.
 - Discs that have labels printed using a special ink that feels tacky when touched.
- Discs with non-standard shapes (e.g., heart, square, star) cannot be played back on this system.
Attempting to do so may damage the system. Do not use such discs.

Cleaning the cabinet

Clean the cabinet, panel and controls with a soft cloth slightly moistened with mild detergent solution. Do not use any type of abrasive pad, scouring powder or solvent such as thinner, benzene or alcohol.

To save a tape permanently

To prevent a tape from being accidentally recorded over, break off the tape tab from side A or B as illustrated.

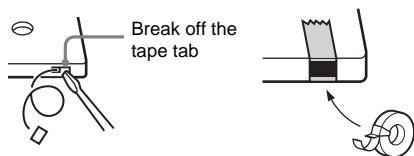

If you later want to reuse the tape for recording, cover the broken tab with adhesive tape.

Before placing a tape in the tape deck

Take up any slack in the tape deck. Otherwise, the tape may get entangled in the parts of the tape deck and become damaged.

When using a tape longer than 90 minutes

The tape is very elastic. Do not change the tape operations such as playback, stop and fast-winding etc. frequently. The tape may get entangled in the tape deck.

Cleaning the tape heads

Clean the tape heads after every 10 hours of use. Be sure to clean the tape heads before you start an important recording or after playing an old tape. Use a separately sold dry-type or wet-type cleaning tape. For details, refer to the instructions of the cleaning tape.

Demagnetizing the tape heads

Demagnetize the tape heads and the metal parts that have contact with the tape after every 20 to 30 hours of use with a separately sold demagnetizing tape. For details, refer to the instructions of the demagnetizing tape.

Specifications

AUDIO POWER SPECIFICATION (MHC-GX9900 USA model only)

POWER OUTPUT AND TOTAL HARMONIC DISTORTION:

With 6-ohm loads, both channels driven, from 120 Hz – 10 kHz; rates 230 watts per channel minimum RMS power, with no more than 10% total harmonic distortion from 250 milliwatts to rated output.

Amplifier section

MHC-GX9900

Total harmonic distortion

Less than 0.1%
(6 ohms at 1 kHz, 100 W)

MHC-GNX100 (HCD-GNX100)

The following are measured at

Mexican model: AC 127 V, 60 Hz

Brazil model: AC 127 V or 220 V, 60 Hz

Other models: AC 120, 220, 240 V,
50/60 Hz

DIN power output (rated) $130 \times 2 + 130 \times 2$ watts
(6 ohms at 1 kHz, DIN)

Continuous RMS power output (reference)
 $175 \times 2 + 175 \times 2$ watts
(6 ohms at 1 kHz,
10% THD)

MHC-GNX100 (SS-WG100)

The following are measured at

Mexican model: AC 127 V, 60 Hz

Brazil model: AC 127 V or 220 V, 60 Hz

Other models: AC 120, 220, 240 V,
50/60 Hz

Continuous RMS power output (reference)
210 watts
(8 ohms at 100 Hz,
10% THD)

MHC-GNX90

The following are measured at

Brazil model: AC 127 V or 220 V, 60 Hz

DIN power output (rated) $210 + 210$ watts
(4 ohms at 1 kHz, DIN)

Continuous RMS power output (reference)
 $275 + 275$ watts
(4 ohms at 1 kHz,
10% THD)

MHC-GNX88 (HCD-GNX88)/MHC-GNX80 (HCD-GNX80)

The following are measured at

Mexican model: AC 127 V, 60 Hz
Brazil model: AC 127 V or 220 V, 60 Hz
Other models: AC 120, 220, 240 V,
50/60 Hz

DIN power output (rated) 180 + 180 watts
(6 ohms at 1 kHz, DIN)

Continuous RMS power output (reference)
225 + 225 watts
(6 ohms at 1 kHz,
10% THD)

MHC-GNX88 (SS-WGV88)/GNX80 (SS-WG80)

The following are measured at

Mexican model: AC 127 V, 60 Hz
Brazil model: AC 127 V or 220 V, 60 Hz
Other models: AC 120, 220, 240 V,
50/60 Hz

Continuous RMS power output (reference)
200 watts
(8 ohms at 100 Hz,
10% THD)

MHC-GNX77/GNX70

The following are measured at

Mexican model: AC 127 V, 60 Hz
Other models: AC 120, 220, 240 V, 60 Hz
DIN power output (rated) 170 + 170 watts
(6 ohms at 1 kHz, DIN)

Continuous RMS power output (reference)
220 + 220 watts
(6 ohms at 1 kHz,
10% THD)

MHC-GNX66/GNX60

The following are measured at

Mexican model: AC 127 V, 60 Hz
Brazil model: AC 127 V or 220 V, 60 Hz
Other models: AC 120, 220, 240 V,
50/60 Hz

DIN power output (rated) 150 + 150 watts
(6 ohms at 1 kHz, DIN)

Continuous RMS power output (reference)
200 + 200 watts
(6 ohms at 1 kHz,
10% THD)

Inputs

VIDEO/MD (AUDIO) IN (phono jacks):
voltage 250/450 mV,
impedance 47 kiloohms

TV (AUDIO) IN (phono jack):
voltage 250 mV,
impedance 47 kiloohms

MIC (phone jack):
sensitivity 1 mV,
impedance 10 kiloohms

Outputs

VIDEO OUT (phono jack):
(MHC-GNX88/GNX77/GNX66 only)
max. output level
1 Vp-p, unbalanced, Sync
negative, load impedance
75 ohms

PHONES (stereo mini jack):
accepts headphones of
8 ohms or more

FRONT SPEAKER: Use only the supplied
speaker
• SS-GNX100
(MHC-GNX100/
GNX80/GNX70/
GX9900)
• SS-GNX90
(MHC-GNX90)
• SS-GNX88
(MHC-GNX88/GNX77)
• SS-GNX66
(MHC-GNX66)
• SS-GNX60
(MHC-GNX60)

SURROUND SPEAKER: Use only the supplied
speaker
• SS-RSX80
(MHC-GNX88/GNX80/
GNX77/GNX70/
GX9900)
• SS-RSX100
(MHC-GNX100)

SUBWOOFER OUT: Use only the supplied
subwoofer
• SS-WG100
(MHC-GNX100)
• SS-WGV88
(MHC-GNX88)
• SS-WG80
(MHC-GNX80)

Disc player section

System	Compact disc and digital audio system
Laser	Semiconductor laser ($\lambda=780$ nm) Emission duration: continuous
Laser Output	Max. 44.6 μ W* *This output is the value measured at a distance of 200 mm from the objective lens surface on the Optical Pick-up Block with 7 mm aperture.
Frequency response	2 Hz – 20 kHz (± 0.5 dB)
Wave length	780 – 790 nm
Signal-to-noise ratio	More than 90 dB
Dynamic range	More than 90 dB

OPTICAL CD DIGITAL OUT

(For MHC-GNX100/GNX90/GNX88/GNX80/
GNX77/GNX70/GNX66/GNX60)

(Square optical connector jack, rear panel)

Wave length	660 nm
Output Level	-18 dBm

Tape deck section

Recording system	4-track 2-channel stereo
Frequency response	50 – 13,000 Hz (± 3 dB), using Sony TYPE I tape
Wow and flutter	$\pm 0.15\%$ W.Peak (IEC) 0.1% W.RMS (NAB) $\pm 0.2\%$ W.Peak (DIN)

Tuner section

FM stereo, FM/AM superheterodyne tuner

FM tuner section

Tuning range	87.5 – 108.0 MHz
Antenna	FM lead antenna
Antenna terminals	75 ohm unbalanced
Intermediate frequency	10.7 MHz

AM tuner section

Tuning range

North and Latin American models:

530 – 1,710 kHz (with the interval set at 10 kHz)
531 – 1,710 kHz (with the interval set at 9 kHz)

Saudi Arabian models:

531 – 1,602 kHz (with the interval set at 9 kHz)

Other models:

531 – 1,602 kHz (with the interval set at 9 kHz)
530 – 1,710 kHz (with the interval set at 10 kHz)

Antenna

AM loop antenna

Antenna terminals

External antenna terminal

Intermediate frequency

450 kHz

Speakers

Front speakers

• SS-GNX90 (MHC-GNX90)

Speaker system	2-way, 3-unit, bass-reflex type
Speaker units	
Woofer:	16 cm, cone type
Tweeter:	2.5 cm, horn type
Nominal impedance	4 ohms
Dimensions (w/h/d) (Approx.)	526 × 291 × 288 mm
Mass (Approx.)	9.5 kg net per speaker

• SS-GNX100 (MHC-GNX100/GNX80/GNX70/GX9900)

• SS-GNX60 (MHC-GNX60)

Speaker system	2-way, 2-unit, bass-reflex type
Speaker units	
Woofer:	20 cm, cone type
Tweeter:	2.5 cm, horn type
Nominal impedance	6 ohms
Dimensions (w/h/d) (Approx.)	280 × 416 × 305 mm
Mass (Approx.)	6.5 kg net per speaker

• SS-GNX88 (MHC-GNX88/GNX77)

• SS-GNX66 (MHC-GNX66)

Speaker system	2-way, 2-unit, bass-reflex type, magnetically shielded
Speaker units	
Woofer:	20 cm, cone type
Tweeter:	2.5 cm, horn type
Nominal impedance	6 ohms
Dimensions (w/h/d) (Approx.)	280 × 416 × 305 mm
Mass (Approx.)	7.1 kg net per speaker

Surround speakers

SS-RSX100 (MHC-GNX100)

Speaker system	2-way, 2-unit, bass-reflex type
Speaker units	
Woofer:	20 cm, cone type
Tweeter:	2.5 cm, horn type
Nominal impedance	6 ohms
Dimensions (w/h/d) (Approx.)	280 × 416 × 305 mm
Mass (Approx.)	6.5 kg net per speaker

SS-RSX80 (MHC-GNX88/GNX80/GNX77/GNX70/GX9900)

Speaker system	2-way, 2-unit, bass-reflex type
Speaker units	
Woofer:	13 cm, cone type
Tweeter:	2.5 cm, horn type
Nominal impedance	24 ohms
Dimensions (w/h/d) (Approx.)	210 × 416 × 257 mm
Mass (Approx.)	4.5 kg net per speaker

Subwoofer

SS-WG100 (MHC-GNX100)

SS-WG80 (MHC-GNX80)

Subwoofer system	1-way, 1-unit, bass-reflex type
Speaker units	
Subwoofer:	20 cm, cone type
Nominal impedance	8 ohms
Dimensions (w/h/d) (Approx.)	265 × 416 × 342 mm
Mass (Approx.)	7.4 kg

SS-WGV88 (MHC-GNX88)

Subwoofer system	1-way, 1-unit, bass-reflex type, magnetically shielded
Speaker units	
Subwoofer:	20 cm, cone type
Nominal impedance	8 ohms
Dimensions (w/h/d) (Approx.)	265 × 416 × 342 mm
Mass (Approx.)	7.8 kg

General

Power requirements

North American models:	120 V AC, 60 Hz
Australian model:	230 – 240 V AC, 50/60 Hz
Mexican model:	127 V AC, 60 Hz
Argentina models:	220 V AC, 50/60 Hz
Brazil model:	127 V or 220 V AC, 60 Hz
	Adjustable with voltage selector

Other models:	120 V, 220 V or 230 – 240 V AC, 50/60 Hz
	Adjustable with voltage selector

Power consumption

MHC-GNX100	350 watts
MHC-GNX90	250 watts
MHC-GNX88/GNX80	350 watts
MHC-GNX77/GNX70	225 watts
MHC-GX9900	250 watts
MHC-GNX66/GNX60	200 watts

Dimensions (w/h/d) (Approx.)

HCD-GNX100	280 × 371 × 398.5 mm
HCD-GNX90/GNX88/GNX80/GNX77/GNX70/ GX9900/GNX66/GNX60	280 × 360 × 398.5 mm

Mass (Approx.)

HCD-GNX100	15.6 kg
HCD-GNX90	12.4 kg
HCD-GNX88	12.8 kg
HCD-GNX80	14.4 kg
HCD-GNX77	11.8 kg
HCD-GNX70	12.1 kg
HCD-GX9900	11.8 kg
HCD-GNX66/GNX60	11.3 kg

Supplied accessories:

Remote Commander (1)
Batteries (2)
AM loop antenna (1)
FM lead antenna (1)
Front speaker pads (8)
Surround speaker pads (8)
(MHC-GNX100/ GNX88/GNX80/ GNX77/GNX70/ GX9900 only)
Subwoofer pads (4)
(MHC-GNX100/ GNX88/GNX80 only)
Speaker cords (2)
(MHC-GNX90 only)
Video cord (1)
(MHC-GNX88/GNX77/ GNX66 only)

Design and specifications are subject to change without notice.

List of button locations and reference pages

How to use page 54 to 56

Use this page to find the location of buttons and other parts of the system, subwoofer and remote that are mentioned in the text.

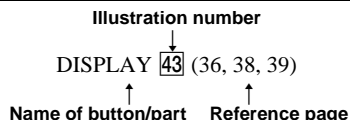

Main unit

ALPHABETICAL ORDER

A – D

ALBUM +/- **19** (16, 17, 18)
 AMP MENU **33** (37)
 AUTO/MANUAL³⁾ **2** (30)
 CD **39** (11, 15, 16, 17, 20, 24, 25, 31, 36)
 CD SYNC **13** (24)
 Deck A **31** (22, 23, 46)
 Deck B **22** (22, 23, 24, 25, 35)
 DIRECTION **18** (22, 24, 25)
 DISC 1 ~ 3 **7** (16, 17)
 Disc tray **9** (14, 15, 44, 46)
 DISPLAY **43** (36, 38, 39)
 Display **44**

E – L

ECHO LEVEL **24** (32)
 ENTER **21** (18, 19, 20, 27, 37, 46)
 EQ BAND **11** (27)
 EX-CHANGE/DISC SKIP **6** (14, 16, 17)
 GROOVE **36** (26)
 ILLUMINATION **42** (38)
 IR Receptor **40**

M – R

MASTER VOLUME **8** (29, 38, 43)
 MIC 1 (jack) **27** (32, 43, 50)
 MIC 2 (jack) **26** (32, 43, 50)
 MIC LEVEL **25** (32, 43)
 MP3 BOOSTER **10** (28)
 MPX⁴⁾ **18** (31, 44, 45)
 OPERATION DIAL **29** (26, 27, 29, 37)
 PHONES (jack) **28** (30, 31, 43)
 Power illuminator **23** (38)
 REC PAUSE/START **16** (24, 25)

S – Z

SOUND FLASH **30** (29)
 SPEAKERS³⁾ **1** (31)
 SURROUND¹⁾ **45** (27)
 SURR SPEAKER MODE²⁾ **45** (28)
 TAPE A/B **37** (22, 23, 24, 25, 35, 36)
 Tape lid **22** **31** (22)
 TUNER/BAND **38** (19, 20, 21, 25, 36)
 TUNING +/- **17** (19, 20, 21)
 TV **35** (25, 36, 41)
 VIDEO/MD **34** (25, 36, 41, 44)
 X-ROUND buttons³⁾ **3** (30)
 WAVE/FADER/BALANCE/
 RANDOM/TWISTER
 X-ROUND JOG³⁾ **4** (30)
 X-ROUND OFF³⁾ **1** (30)

SYMBOLS

I/⏻ (power) **41** (10, 11, 20, 41, 43, 46)
 ▲ OPEN/CLOSE **5** (14, 16, 44)
 ◀▶ (play) **12** (15, 18, 22, 23, 24, 25, 35, 44)
 ◀▶▶▶ (go backward/forward) **17** (16, 18, 25, 34, 46)
 ◀▶▶▶ (rewind/fast forward) **19** (16, 23, 45, 46)
 II (pause) **14** (16, 23)
 ■ (stop) **15** (16, 20, 23, 24, 25, 44, 46)
 ▲ A (Eject A) **32**
 B ▲ (Eject B) **20**

¹⁾ For MHC-GNX100/GNX66/
 GNX60

²⁾ For MHC-GNX88/GNX80/
 GNX77/GNX70/GX9900

³⁾ MHC-GNX100 only

⁴⁾ For MHC-GNX88/GNX77/
 GNX66

Top Panel

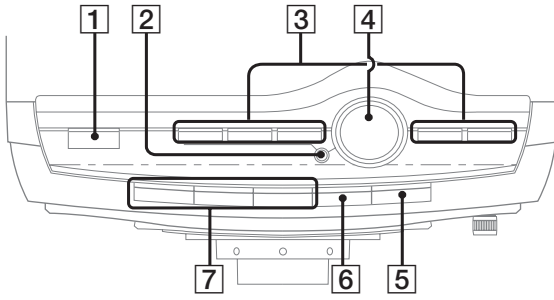

Front Panel

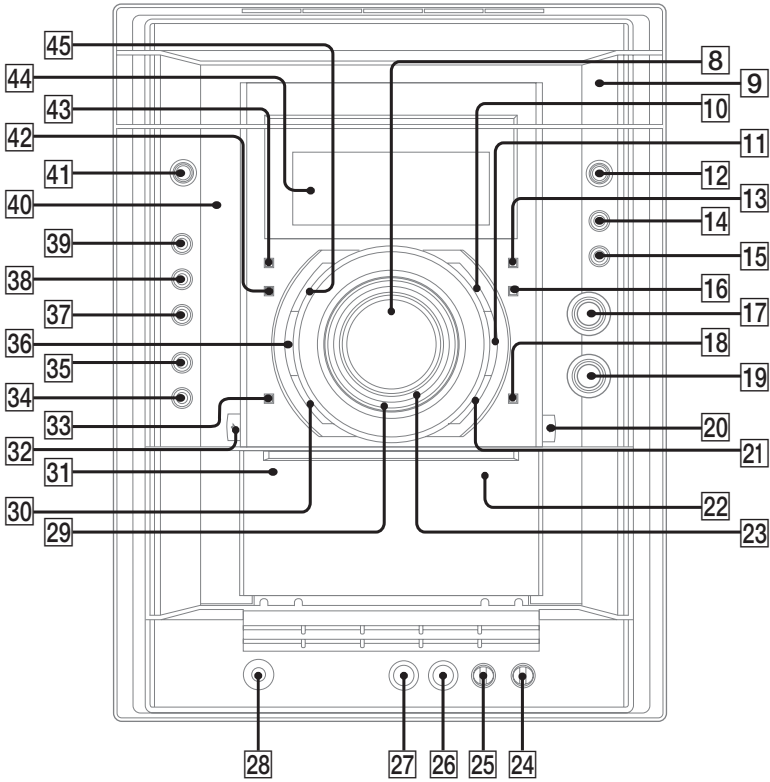

Subwoofer

(MHC-GNX100/GNX88/GNX80 only)

ALPHABETICAL ORDER

A - Z

SUBWOOFER LEVEL [4] (29)

SUBWOOFER ON/OFF [1] (29)

MHC-GNX100 only

SPEAKERS [5]

SPEAKERS A (indicator) [6] (31)

SPEAKERS A+B (indicator) [2] (31)

SPEAKERS B (indicator) [3] (31)

MHC-GNX88/GNX80 only

LINK (indicator) [6] (28)

MATRIX SURR 1 (indicator) [3] (28)

MATRIX SURR 2 (indicator) [2] (28)

SURROUND SPEAKER MODE [5] (28)

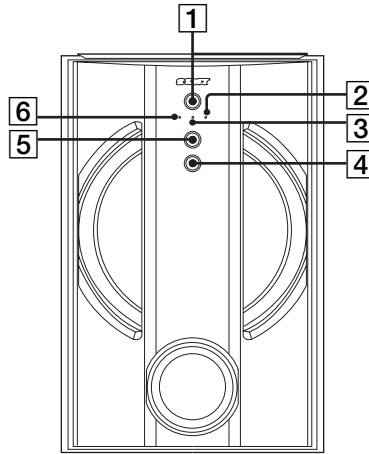

Remote control

ALPHABETICAL ORDER

A - E

ALBUM + [14] (16, 17, 18)

ALBUM - [16] (16, 17, 18)

CD [24] (15, 16, 17, 24, 25, 31)

CLEAR [18] (18)

CLOCK/TIMER SELECT [2] (34, 35, 47)

CLOCK/TIMER SET [4] (13, 33, 35)

DISC SKIP [13] (16, 17)

DISPLAY [26] (36, 38, 39)

ENTER [12] (13, 18, 19, 20, 27, 33, 34, 35, 37)

EQ [17] (26)

F - Z

FM MODE [6] (21, 45)

FUNCTION [8] (16, 20, 21, 23, 25, 41)

PLAY MODE [5] (15, 17, 18, 24, 25, 44, 46)

REPEAT [6] (17)

SLEEP [1] (33)

TAPE [23] (22, 23, 25, 35)

TUNER/BAND [7] (19, 20, 21)

TUNER MEMORY [25] (19, 20)

TUNING MODE [5] (19, 20, 21)

VOLUME +/- [15] (29, 33, 38, 43)

The + button has a tactile dot.*

SYMBOLS

I/⏻ (power) [3] (13)

■ (stop) [11] (16, 23, 24, 25, 44)

⏸ (pause) [19] (16, 23)

▶ (play) [20] (15, 18, 22, 23, 24, 25, 35, 44)

◀◀ (go backward) [22] (13, 16, 18, 19, 20, 21, 25, 34)

▶▶ (go forward) [21] (13, 16, 18, 19, 20, 21, 25, 34)

◀◀ (rewind) [10] (16, 23, 45)

▶▶ (fast forward) [9] (16, 23, 45, 46)

* Use the tactile dot as a reference when operating the system.

