

For details, see the Operating Instructions.  
Para mais detalhes, consulte o Manual de Instruções.

## Quick Setup Guide/Guia de Instalação Rápida

DAV-DZ280

### 1 Connecting the speakers/Ligar as colunas

Connect the speaker cords to match the color of the SPEAKER jacks of the unit.  
Ligue os cabos das colunas de acordo com a cor das tomadas SPEAKER da unidade.

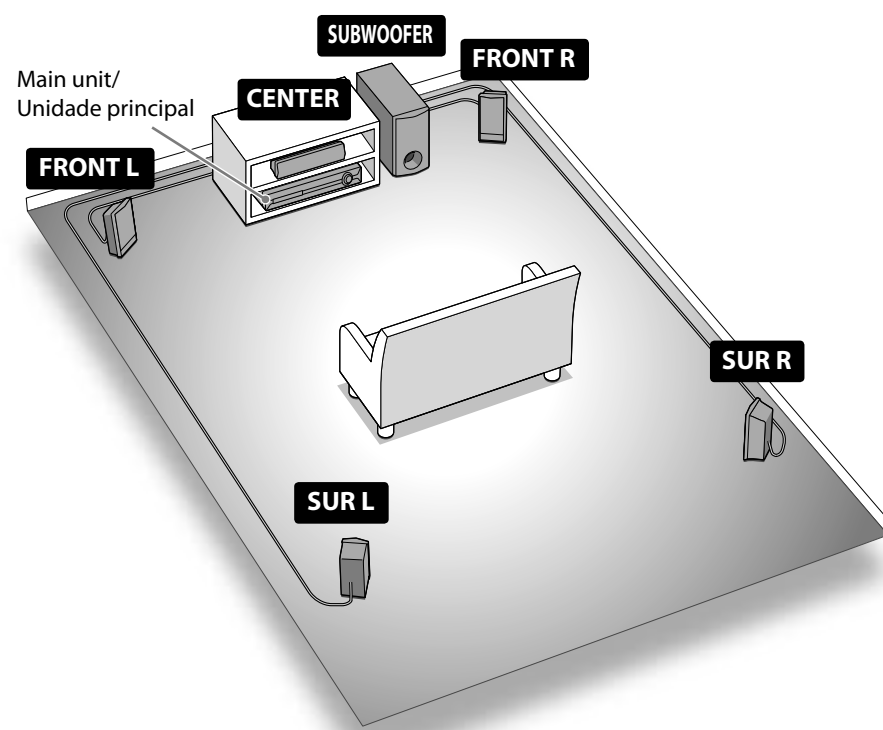

- For the best possible surround sound, place all speakers at the same distance from the listening position.
- The subwoofer can be placed anywhere in the room.
- All speakers other than the subwoofer should be set at ear level.

- Para obter o melhor som surround, coloque todas as colunas à mesma distância em relação à posição de audição.
- O subwoofer pode ser colocado em qualquer parte da sala.
- Todos os cabos excepto o do subwoofer devem ser posicionados ao nível dos ouvidos.

To connect speaker cords to the speaker/Ligar os cabos das colunas às colunas

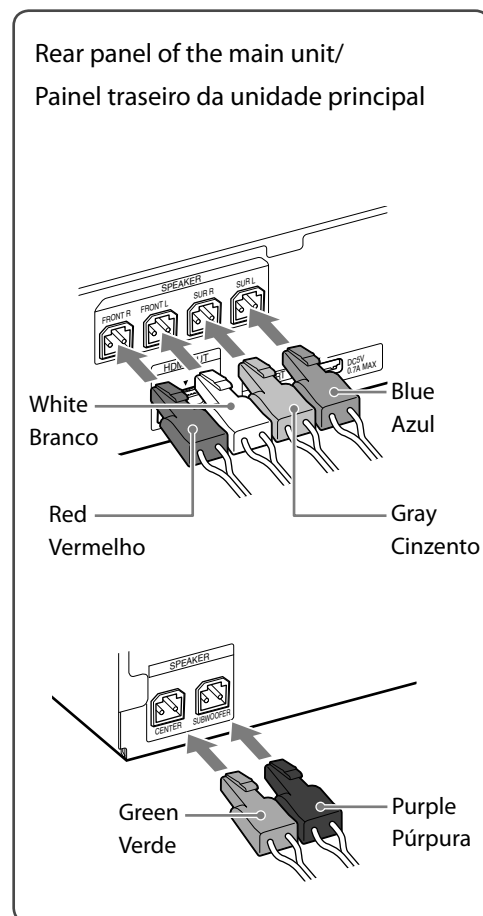
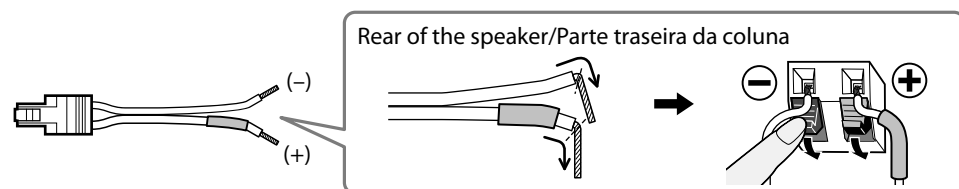

### 2 Connecting the TV/Ligar o televisor

Depending on the jacks on your TV, select the connection method.  
Dependendo das tomadas do seu televisor, seleccione o método de ligação.

#### Method 1: SCART (EURO AV) cable connection Método 1: ligação do cabo SCART (EURO AV)

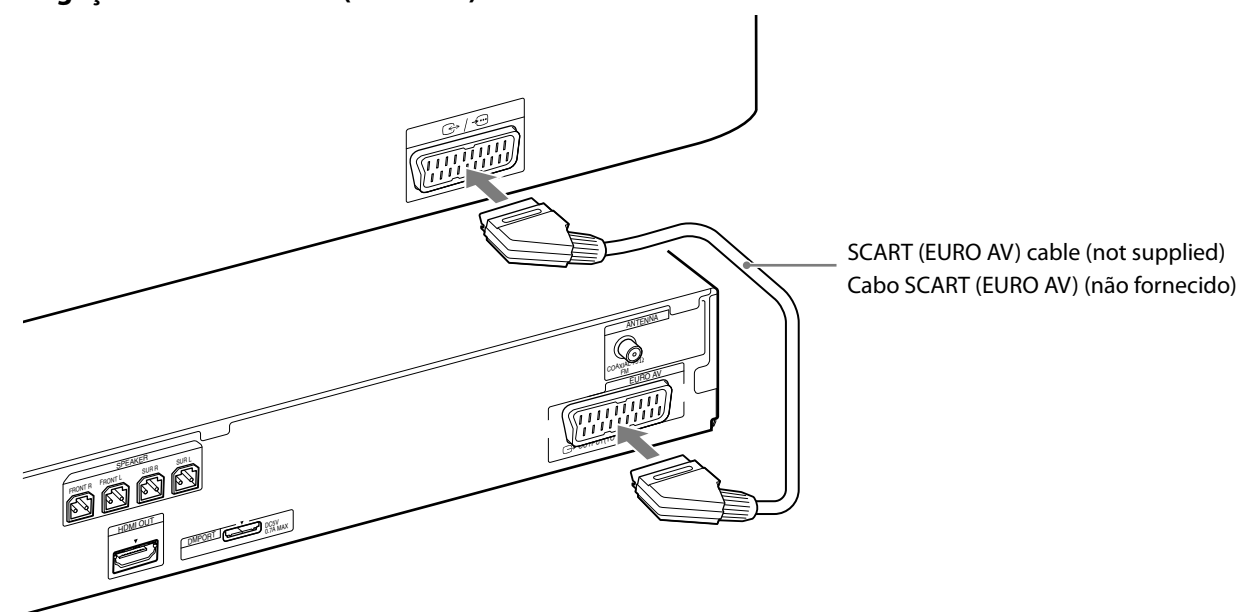

#### Method 2: HDMI cable and SCART (EURO AV) cable connection Método 2: ligação do cabo HDMI e do cabo SCART (EURO AV)

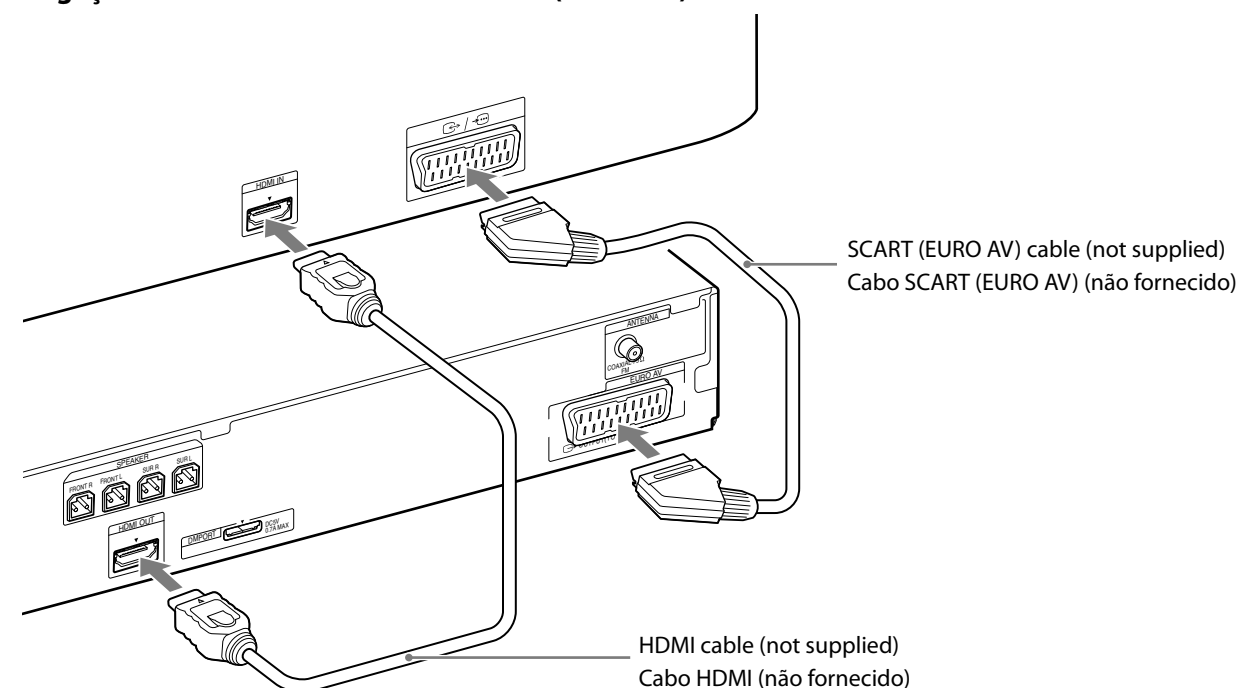

### 3 Performing the Quick Setup/Realização da Instalação rápida

**Note**

Do not insert a disc before performing the Quick Setup.

**Nota**

Não introduza um disco antes de realizar a Instalação Rápida.

#### 1 Connect the AC power cord (mains lead).

The shape of the wall outlet (mains) differs depending on the area.

#### Ligue o cabo de alimentação CA.

O formato da tomada de parede pode variar consoante a região.

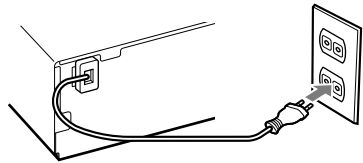

#### 2 Turn on the power of the main unit and TV.

Ligue a alimentação da unidade principal e a televisão.

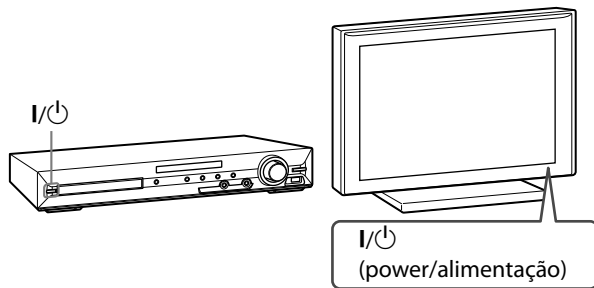

#### 3 Switch the input selector on your TV to display "Sony Home Theatre System."

Regule o selector de entrada do televisor de modo a ser exibido "SONY Home Theatre System."

#### 4 Set each following item, using ←/↑/↓/→ and ⊕.

Displayed items vary depending on the area.

Configure cada um dos seguintes itens utilizando ←/↑/↓/→ e ⊕.

Os itens apresentados variam consoante a região.

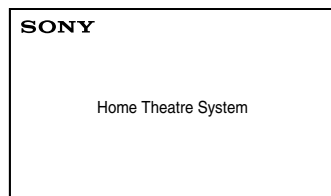
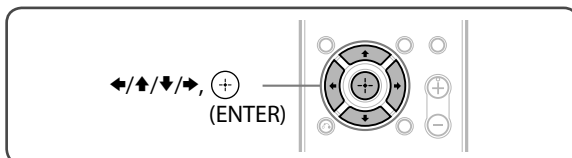

Select an on-screen language.

Selecione um idioma de visualização no ecrã.

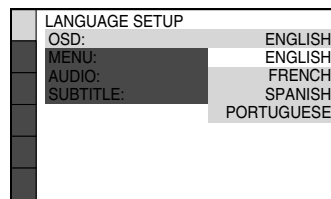

Select the aspect ratio of the connected TV.

Selecione o formato do televisor ligado.

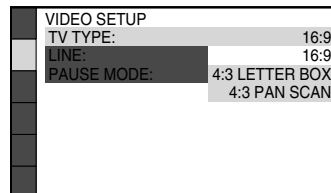

Select the output method for video signals.

Selecione o método de saída para sinais de vídeo.

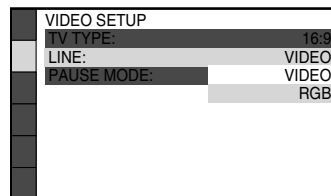

Select [ON] when you connect the main unit and the TV with an HDMI cable.

Selecione [ACTIVADO] quando ligar a unidade principal e o televisor com um cabo HDMI.

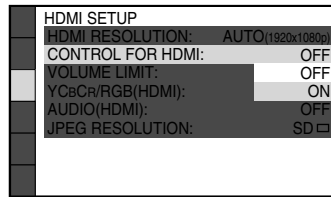

Select the speaker formation.

Selecione a formação das colunas.

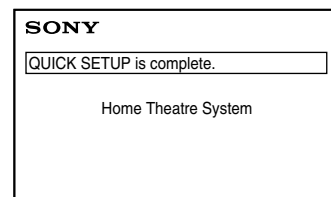
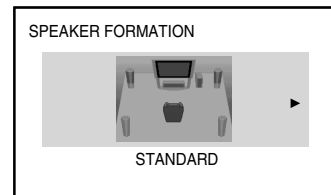

### Listening to TV sound from all speakers/Ouvir som do televisor a partir de todas as colunas

#### 1 Press FUNCTION +/- to display "TV."

Prima FUNCTION +/- para apresentar "TV".

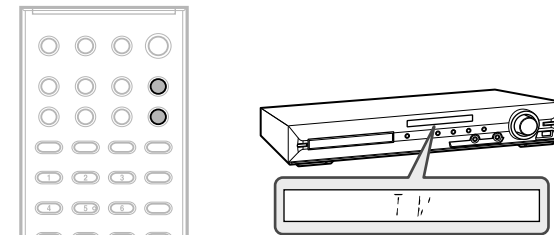

#### 2 Press SYSTEM MENU.

Prima SYSTEM MENU.

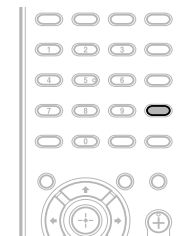

#### 3 Press ↑/↓ to display "DEC. MODE," then press ⊕.

Prima ↑/↓ para apresentar "DEC. MODE", e prima ⊕.

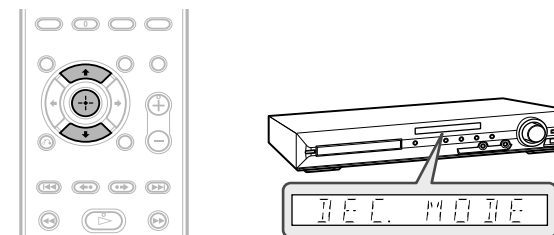

#### 4 Press ↑/↓ to display "PRO LOGIC," then press ⊕.

Prima ↑/↓ para apresentar "PRO LOGIC", e prima ⊕.

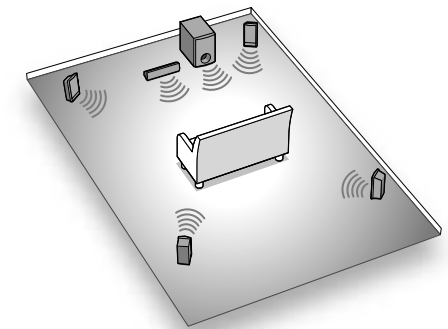
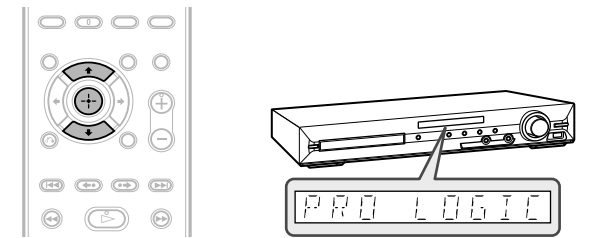

#### 5 Press SYSTEM MENU to exit the menu.

Prima SYSTEM MENU para sair do menu.

