

# Display Side Hi-Fi Component System

---

## Operating Instructions

## Owner's Record

The model and serial numbers are located on the rear of the unit. Record the serial number in the space provided below. Refer to them whenever you call upon your Sony dealer regarding this product.

Model No. \_\_\_\_\_ Serial No. \_\_\_\_\_



**digipad**

\* DHC-FL7D only

**DHC-FL7D**  
**DHC-FL5D**

## WARNING

**To prevent fire or shock hazard, do not expose the unit to rain or moisture.**

To avoid electrical shock, do not open the cabinet. Refer servicing to qualified personnel only.

Do not install the appliance in a confined space, such as a bookcase or built-in cabinet.

CLASS 1 LASER PRODUCT  
LUOKAN 1 LASERLAITE  
KLASS 1 LASERAPPARAT

This appliance is classified as a CLASS 1 LASER product. This label is located on the rear exterior.

### CAUTION

The use of optical instruments with this product will increase eye hazard.

As the laser beam used in this CD/DVD player is harmful to eyes, do not attempt to disassemble the cabinet. Refer servicing to qualified personnel only.

### U.S.A. model

This label is located inside the unit.

**CAUTION-**  
**Laser radiation when open.**  
**DO NOT STARE INTO BEAM.**

### European model

The following caution label is located inside the apparatus.

CAUTION : VISIBLE AND INVISIBLE LASER RADIATION WHEN OPEN; AVOID EXPOSURE TO BEAM.  
ADVARSEL : SYNLIG OG USYNLIG LASERSTRÅLING VED ÅBNING. UNNGÅ UDSÆTTELSE FOR STRÅLING.  
VORSICHT : SICHTBARE UND UNSICHTBARE LASERSTRÄHLUNG WENN ABDECKUNG GEÖFFNET. NICHT DEM STRAHLEN AUSSETZEN.  
VARO! : NÄKYVÄÄ JA NÄKYMÄTÖN AVATTAESSA OLET ALLTIINA LASERSÄTELYLLE. ÄLÄ KATSO SÄTEELSEEN.  
VARNING : SYNLIG OCH OSYNLIG LASERSTRÅLNING NÄR DENNA DEL ÄR ÖPPNAD. STRÅLEN ÄR FARLIG.  
ADVARSEL : SYNLIG OG USYNLIG LASERSTRÅLING NÄR DEKSEL ÅPNES. UNNGÅ EKSPONERING FOR STRÅLEN.  
FIGYELEM : A BURKOLAT MEGBONTÁSÁKOR LÁTHATÓ ÉS LÁTHATÁTLAN LEZÉRSUGÁR LEHET. NÉ A KÉSZÜLÉKHOZ. ÖVAKODJON A KÖZVETLEN LEZÉRSUGÁRTÓL!

To prevent fire, do not cover the ventilation of the apparatus with news papers, table-cloths, curtains, etc. And don't place lighted candles on the apparatus.

To prevent fire or shock hazard, do not place objects filled with liquids, such as vases, on the apparatus.



Don't throw away the battery with general house waste, dispose of it correctly as chemical waste.

## NOTICE FOR THE CUSTOMERS IN THE U.S.A.

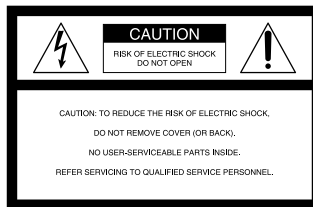

This symbol is intended to alert the user to the presence of uninsulated "dangerous voltage" within the product's enclosure that may be of sufficient magnitude to constitute a risk of electric shock to persons.



This symbol is intended to alert the user to the presence of important operating and maintenance (servicing) instructions in the literature accompanying the appliance.

### WARNING

This equipment has been tested and found to comply with the limits for a Class B digital device, pursuant to Part 15 of the FCC Rules. These limits are designed to provide reasonable protection against harmful interference in a residential installation. This equipment generates, uses, and can radiate radio frequency energy and, if not installed and used in accordance with the instructions, may cause harmful interference to radio communications. However, there is no guarantee that interference will not occur in a particular installation. If this equipment does cause harmful interference to radio or television reception, which can be determined by turning the equipment off and on, the user is encouraged to try to correct the interference by one or more of the following measures:

- Reorient or relocate the receiving antenna.
- Increase the separation between the equipment and receiver.
- Connect the equipment into an outlet on a circuit different from that to which the receiver is connected.
- Consult the dealer or an experienced radio/TV technician for help.

### CAUTION

You are cautioned that any changes or modifications not expressly approved in this manual could void your authority to operate this equipment.

### Note to CATV system installer

This reminder is provided to call the CATV system installer's attention to Article 820-40 of the NEC that provides guidelines for proper grounding and, in particular, specifies that the cable ground shall be connected to the grounding system of the building, as close to the point of cable entry as practical.

### NOTICE FOR THE CUSTOMERS IN CANADA

#### CAUTION:

**TO PREVENT ELECTRIC SHOCK, DO NOT USE THIS POLARIZED AC PLUG WITH AN EXTENSION CORD, RECEPTACLE OR OTHER OUTLET UNLESS THE BLADES CAN BE FULLY INSERTED TO PREVENT BLADE EXPOSURE.**

Except for European model



ENERGY STAR® is a U.S. registered mark. As an ENERGY STAR® partner, Sony Corporation has determined that this product meets the ENERGY STAR® guidelines for energy efficiency.

This system incorporates Dolby\* Digital, Pro Logic Surround, and the DTS\*\* Digital Surround System.

\* Manufactured under license from Dolby Laboratories.

"Dolby", "Pro Logic" and the double-D symbol are trademarks of Dolby Laboratories.

\*\* Manufactured under license from Digital Theater Systems, Inc. "DTS" and "DTS Digital Surround" are registered trademarks of Digital Theater Systems, Inc.

### Notes on DTS audio playback

Excessive noise may be heard from the speakers when you play DTS format CDs if the decode format is set to PCM (page 53) or monaural sound (1/L, 2/R) (page 33). Set the volume to minimum and be careful not to damage your speaker system.

## IMPORTANT NOTICE

**Caution:** This system is capable of holding a still video image or on-screen display image on your television screen indefinitely. If you leave the still video image or on-screen display image displayed on your TV for an extended period of time, you risk permanent damage to your television screen. Projection televisions are especially susceptible to this.

# Table of Contents

This system can play the following discs.. 6

## List of Buttons and Reference Pages

Main unit .....	7
Remote Control .....	8
digipad operations .....	9

## Getting Started

Hooking up the system .....	10
Inserting three R6 (size AA) batteries into the remote .....	13
Setting up your speakers .....	14
Specifying the speaker parameters .....	15
Setting the clock .....	16

## DVD/VIDEO CD/CD/Super Audio CD/MP3

### Playing discs:

Loading a disc .....	17
Playing a disc	
— Normal Play/Shuffle Play/Repeat Play/Scan/Slow-motion Play .....	17
Playing a disc with MP3 audio tracks .....	19
Creating your own program	
— Program Play .....	22
Resuming playback from the point you stopped the disc	
— Resume Play .....	23
Playing repeatedly	
— Repeat Play .....	24
Playing DVDs using the menu .....	25
Playing VIDEO CDs with PBC functions (Ver. 2.0)	
— PBC Play .....	25

### Setting up for DVD/VIDEO CD/CD:

Using the Setup Display .....	26
Setting the display or sound track language	
— LANGUAGE SETUP .....	27
Settings for the display	
— SCREEN SETUP .....	28
Custom settings	
— CUSTOM SETUP .....	29
Speaker settings	
— SPEAKER SETUP .....	30

### Viewing information about the disc:

Checking the playing time and remaining time .....	32
--	----

### Sound adjustment:

Changing the sound .....	33
--------------------------	----

### Enjoying movies:

Searching for a title/chapter	
/track/index .....	35
Changing the angles .....	36
Displaying the subtitles .....	36

### Using various additional functions:

Locking discs	
— CUSTOM PARENTAL CONTROL/PARENTAL CONTROL .....	37

---

## Tuner

Presetting radio stations .....	41
Listening to the radio .....	42
Using the Radio Data System (RDS)* ....	43

---

## Tape

Loading a tape .....	44
Playing a tape .....	44
Recording to a tape	
— CD Synchro Recording/High-Speed	
Dubbing/Recording Manually/Program	
Edit .....	45
Timer-recording radio programs .....	47

---

## Sound Adjustment

Adjusting the sound .....	48
Selecting the sound effect .....	48
Enjoying Dolby Pro Logic II	
(DHC-FL7D only) .....	49
Adjusting the sound effects .....	50
Creating a personal sound effect file	
— Personal file .....	51

---

## Display

Turning off the display	
— Power Saving Mode .....	52
Using the display .....	52

---

## Other Features

To adjust the brightness of the display ....	53
To listen to multi channel sound .....	53
Singing along: Karaoke** .....	54
About indicators .....	55
Falling asleep to music	
— Sleep Timer .....	55
Waking up to music	
— Daily Timer .....	56

---

## Optional Components

Hooking up optional components .....	57
Listening to audio from a connected	
component .....	58
Recording audio from a connected	
component .....	59
Recording on a connected component ....	59

---

## Troubleshooting

Problems and remedies .....	60
-----------------------------	----

---





## Additional Information

Precautions .....	65
Specifications .....	67
Glossary .....	70
Language code list .....	73
Control Menu Item List .....	74
Setup Display Item List .....	75

\* European model only.

\*\* Except for North American and European models.

## This system can play the following discs

Format of discs	Disc logo
DVD VIDEO*	
Super Audio CD**	
VIDEO CD	
Music CD	

\* The "DVD VIDEO" logo is a trademark.

\*\*DHC-FL7D only

### Discs that this system cannot play

- CD-ROMs (PHOTO CDs included)
- All CD-Rs other than music and VCD format CD-Rs
- Data part of CD-Extras
- DVD-ROMs
- DVD Audio discs

#### Note

Some CD-Rs/CD-RWs or DVD-Rs/DVD-RWs cannot be played on this system depending upon the format or the recording quality or physical condition of the disc, or the characteristics of the recording device.

Furthermore, the disc will not play if it has not been correctly finalized. For more information, see the operating instructions for the recording device.

### Region code of DVDs you can play on this system

Your system has a region code printed on the back of the unit and will only play DVDs labeled with identical region code.

DVDs labeled  will also be played on this system.

If you try to play any other DVD, the message "Playback prohibited by area limitations." will appear on the TV screen.

Depending on the DVD, no region code indication may be labeled even though playing the DVD is prohibited by area restrictions.

The region code is located below the COMPONENT VIDEO OUT jacks on the rear panel.

Note on playback operations of DVDs and VIDEO CDs

Some playback operations of DVDs and VIDEO CDs may be intentionally set by software producers. Since this system plays DVDs and VIDEO CDs according to the disc contents the software producers designed, some playback features may not be available. Also, refer to the instructions supplied with the DVDs or VIDEO CDs.

Note on PBC (Playback Control) (VIDEO CDs)

This system conforms to Ver. 1.1 and Ver. 2.0 of VIDEO CD standards. You can enjoy two kinds of playback depending on the disc type.

Disc type	You can
VIDEO CDs without PBC functions (Ver. 1.1 discs)	Enjoy video playback (moving pictures) as well as music.
VIDEO CDs with PBC functions (Ver. 2.0 discs)	Play interactive software using menu screens displayed on the TV screen (PBC Playback), in addition to the video playback functions of Ver. 1.1 discs. Moreover, you can play high-resolution still pictures, if they are included on the disc.

### Copyrights

This product incorporates copyright protection technology that is protected by method claims of certain U.S. patents, other intellectual property rights owned by Macrovision Corporation, and other rights owners. Use of this copyright protection technology must be authorized by Macrovision Corporation, and is intended for home and other limited viewing uses only unless otherwise authorized by Macrovision Corporation. Reverse engineering or disassembly is prohibited.

How to use this page

Use this page to find the location of buttons and other parts of the system that are mentioned in the text.

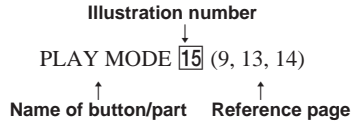

## Main unit

### ALPHABETICAL ORDER

#### A - D

- 2.ICH/MULTI (North American and European models only) **19** (16, 48, 53, 59, 61)
- CD SYNC HI-DUB **13** (45, 47)
- DIGITAL **24** (57)
- DISC SELECT **4** (17, 18)
- DISC 1 indicator **29** (17)
- DISC 2 indicator **28** (17)
- DISC 3 indicator **27** (17)
- DISC 4 indicator **26** (17)
- DISC 5 indicator **25** (17)
- Display window **2**
- DISPLAY **22** (32, 43, 52, 53, 60, 64)
- DVD **33** (18, 19, 21, 45)
- DVD MENU **12** (25, 27)
- DVD TOP MENU **11** (25)

#### E - R

- ECHO LEVEL (Asian model only) **21** (54)
- EFFECT (North American and European models only) **20** (48, 50, 59)
- GROOVE (North American and European models only) **21** (48, 64)
- MD (VIDEO) (Except for North American model) **23** (59)
- MIC jack (Except for North American and European models) **19** (54)
- MIC LEVEL (Except for North American and European models) **20** (54)
- MULTI CHANNEL DECODING indicator **3**
- PHONES jack **16**
- REC PAUSE/START **14** (45, 46)
- Remote sensor **30**

#### T - V

- TAPE A/B **31** (44, 45, 54)
- TUNER/BAND **32** (41, 42)
- VIDEO (MD) (North American model only) **23** (58)
- VOLUME **15**

### BUTTON DESCRIPTIONS

- I/O (power) **1**
- ▲ (disc tray) **5**
- ▲ A (deck A) **18**
- ▲ B (deck B) **17**
- ◁ ▷ (play) **6**
- || (pause) **8**
- (stop) **7**
- ◀ ▶ (go back/go forward) **9**
- /◀ ▶/+ (rewind, fast forward) **10**

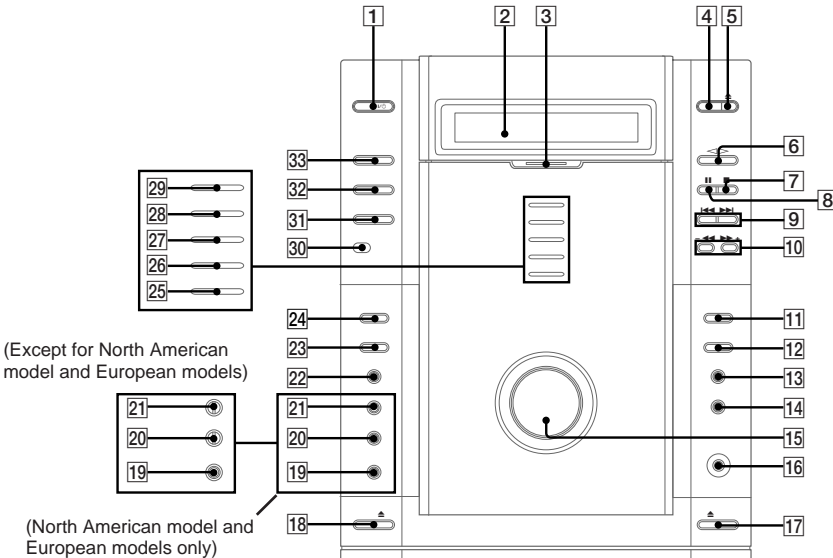

# Remote Control

## ALPHABETICAL ORDER

### A - E

- 2.1CH/MULTI\* **30** (16, 48, 53, 59, 61)  
 ALBUM +/- **33** (20)  
 AMP MENU **9** (14, 15, 31, 49, 53)  
 ANGLE **38** (36, 62)  
 AUDIO **39** (27, 29, 33)  
 CLEAR **19** (21-24, 30, 35)  
 CLOCK/TIMER SELECT\* **24** (47, 56)  
 CLOCK/TIMER SET **24** (16, 47, 56)  
 D.SKIP **5** (18, 21, 46)  
 digipad **7** (9)  
 DISPLAY **4** (32, 43, 52, 53, 60, 64)  
 DSP EDIT\* **37** (50, 51)  
 DVD **16** (17, 18, 21, 25, 29, 32-36, 40, 45, 52, 57, 59, 61-64, 66, 70)  
 DVD DISPLAY **11** (20, 23, 24, 26, 32, 33, 35-39)  
 DVD MENU **15** (25, 27)  
 DVD SETUP\* **9** (26, 31, 38)  
 DVD TOP MENU **17** (25)  
 EFFECT\* **32** (48, 50, 59)  
 ENTER **6** (14-16, 18, 20, 21, 23-26, 33, 35-41, 46, 47, 49-51, 53, 56, 64)

### F - S

- FUNCTION **10** (19, 45, 54, 58, 59, 63)  
 GAME MODE **36** (48)  
 GROOVE\* **34** (48)  
 KARAOKE PON\* **36** (54)  
 MOVIE MODE **32** (48)  
 MUSIC MODE **37** (48)  
 Numeric buttons **23** (18, 22, 25, 35, 38-40, 42)  
 P FILE\* **39** (51)  
 PLAY MODE/DIRECTION **20** (17, 19, 21, 22, 44-46, 54, 62)  
 PRESET +/- **27**  
 PREV/NEXT **27**  
 REPEAT/FM MODE **22** (18, 20, 22, 64)  
 RETURN **30** (25, 35, 38, 39)  
 SCAN/SLOW **41** (18)  
 SELECT **28**  
 SHIFT **13**  
 SLEEP **25** (55)  
 SUBTITLE **31** (27, 36)

### T - V

- TAPE A/B **12** (44, 45, 54)  
 TOOL MODE **34** (48)  
 TUNER MEMORY\* **20** (41)  
 TUNER/BAND **14** (41, 42)  
 TUNING +/- **41**  
 TV/VIDEO **26** (13)  
 TV I/⏻ **1** (13)  
 TV CH +/- **3** (13)  
 TV VOL +/- **2** (13)  
 VOLUME +/- **8**

## BUTTON DESCRIPTIONS

- I/⏻ (power) **18**  
 ◀▶ (play) **28**  
 ⏸ (pause) **40**  
 ■ (stop) **29**  
 ◀◀ (go back) **27**  
 ▶▶ (go forward) **27**  
 ◀◀ (rewind) **41**  
 ▶▶ (fast forward) **41**  
 ⏮/⏪/⏩/⏭/ENTER **35**  
 >10 **21**

\* To use these functions, press the button while pressing SHIFT.

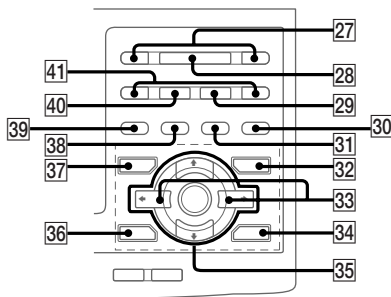
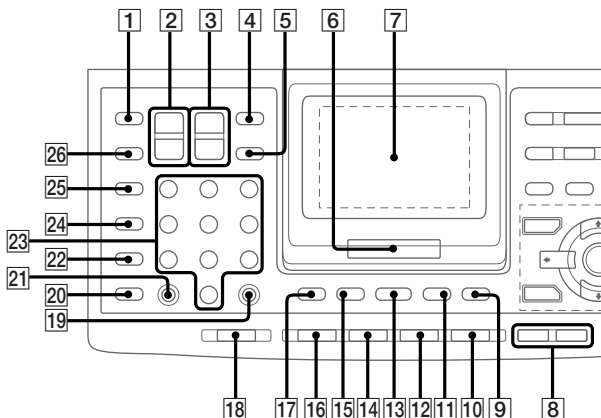



# digipad operations

The remote is equipped with an unique digipad multi controlling device. You can control various operations with this digipad. When touching the digipad, do not use utensil whose end is sharpened. When this unit does not respond to the digipad operations, press the digipad a little harder.

## DVD, TUNER, TAPE A/B functions

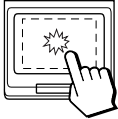

Basic operation	DVD, TUNER, TAPE A/B
Tap once	◀▶ (Start playback)*
Tap twice	■ (Stop playback)

\* When you tap the digipad while playing a CD, playback pauses. Tap again to resume playback.

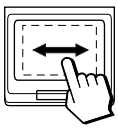

Slide from the left to the right ▶▶ (AMS +, preset +)\*\*

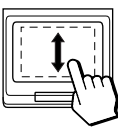

Slide from the right to the left ◀◀ (AMS -, preset -)\*\*



Slide from lower side to upper side ▶▶ (Fast forward, tuning +)\*\*



Slide from upper side to lower side ◀◀ (Rewind, tuning -)\*\*

\*\* If you keep on moving, you can operate as pressing and holding these buttons.

## Adjusting the equalizer curve in EQ EDIT operations (page 50)

The curve made by sliding the finger is reflected in the display.

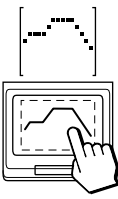

## Selecting parameters in DSP EDIT and other adjustments (page 50)

Slide in the direction until you reach the value you want (refer to each of the operations).

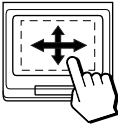

## Adjusting the position of the digipad

When the digipad operation is not carried out properly or when you replace the batteries, perform the following procedure. When carrying out this operation, make sure to point the remote toward the main unit.

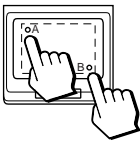

- 1 Turn on the system.
- 2 Press DISPLAY and ◀◀ on the remote at the same time.  
"CALIBRATION" flashes in the display.
- 3 Tap the dot at the left upper corner of the digipad.  
"A PUSHED" appears in the display, then "CALIBRATION" flashes.
- 4 Tap the dot at the right bottom corner of the digipad.  
"B PUSHED" appears in the display, then "CALIBRATION" flashes.
- 5 Press ENTER on the remote.  
"CAL END" appears in the display.

## Hooking up the system

Do the following procedure **1** to **6** to hook up your system using the supplied cords and accessories.

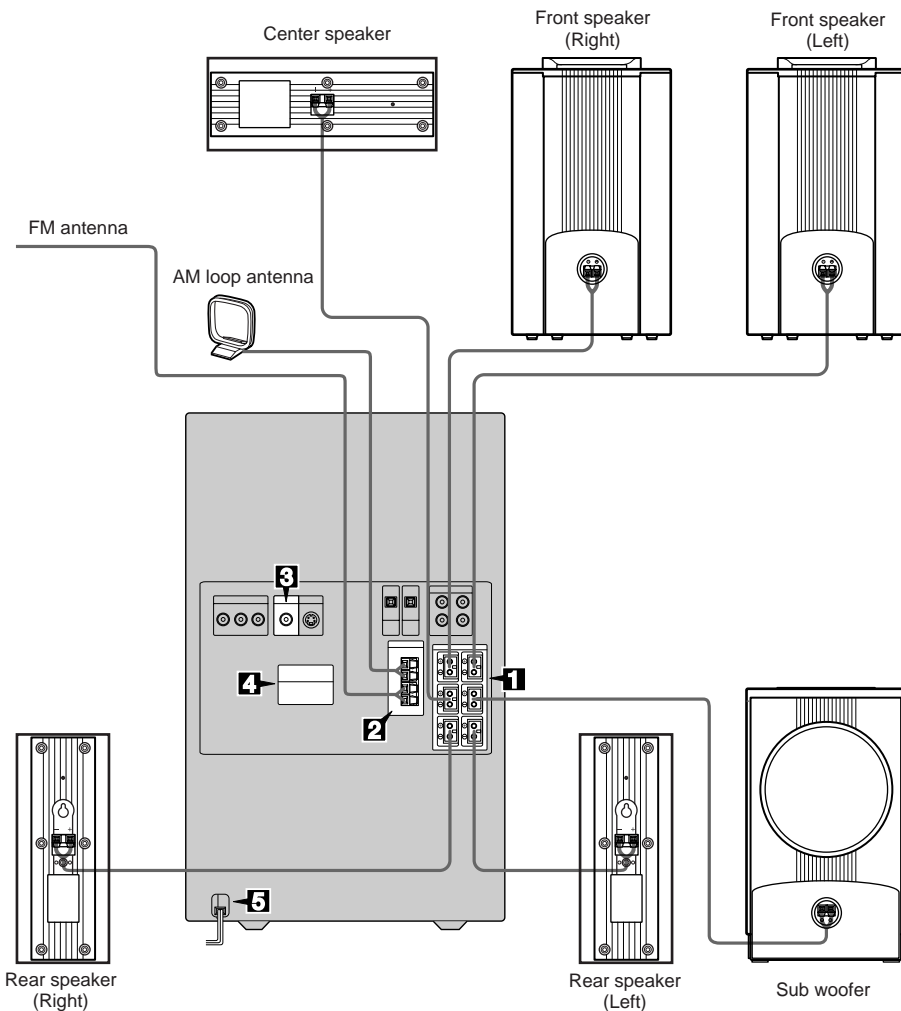

Connect the	To the
Front speakers	SPEAKER FRONT L (white) and R (red) terminals
Rear speakers	SPEAKER REAR L (blue) and R (gray) terminals
Center speaker	SPEAKER CENTER (green) terminal
Sub woofer	SPEAKER WOOFER (purple) terminal

## 1 Connect the speakers.

Connecting speaker cords  
Main unit

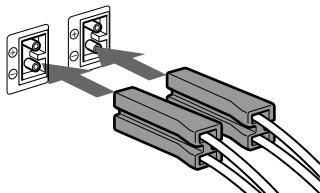

Speaker

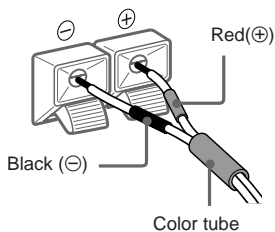

### Note

Be sure to match the speaker cord to the appropriate terminal on the components:  $\oplus$  to  $\oplus$ , and  $\ominus$  to  $\ominus$ . If the cords are reversed, the sound will be distorted and will lack bass.

## 2 Connect the FM/AM antennas.

Set up the AM loop antenna, then connect it.

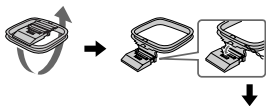

Jack type **A**

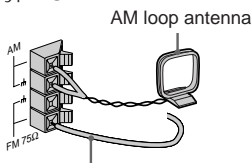

Extend the FM lead antenna horizontally.

Jack type **B**

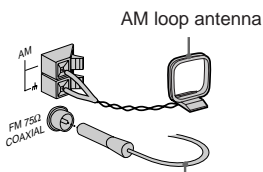

Extend the FM lead antenna horizontally.

## 3 Connect the video input jack of your TV to the VIDEO OUT jack with the video cable.

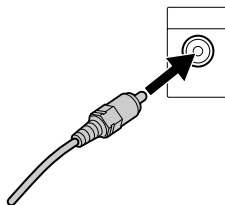

When using a TV

Turn on the TV and select the video input so you can view the pictures from this system.

### Tips

- For even higher quality video images;
  - Use an optional component video cable to connect the COMPONENT VIDEO input jacks on your TV to the COMPONENT VIDEO OUT jacks of this system. If your TV is compatible with progressive format file signals, use this connection and set “COMPONENT OUT” to “PROGRESSIVE” in “SCREEN SETUP” (page 28).
  - Use an optional S-video cable to connect the S VIDEO input jack on your TV to the S VIDEO OUT jack of this system.
- If you connect a video deck between this unit and the TV, you may experience video leakage when watching the video signal from this unit. Do not connect a video deck between this unit and the TV.

## 4 For models with a voltage selector, set VOLTAGE SELECTOR to the position of your local power line voltage.

Refer to the print on your system's VOLTAGE SELECTOR for available settings.

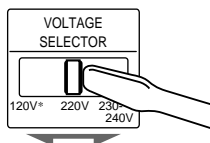

\* Saudi Arabian Model 120 -127 V

**continued**

## Hooking up the system (continued)

### 5 Connect the power cord to a wall outlet.

The demonstration appears in the display. When you press **I/⏻**, the system turns on and the demonstration automatically ends. If the supplied adaptor on the plug does not fit your wall outlet, detach it from the plug (only for models equipped with an adaptor).

### 6 (Except for Pan American and European models)

#### Set the color system according to your TV.

The color system is factory set to NTSC for region code 3 models, and PAL for other region code models. Each time you perform the procedure below, the color system changes as follows:

NTSC ↔ PAL

Use the buttons on the unit.

- 1 Press **I/⏻** to turn off the system.
- 2 Press **I/⏻** while holding down **III**.  
The system turns on and the color system is changed.

Before connecting the Center and Rear speakers

Stick the supplied speaker pads to the bottom of the center speaker and rear speakers to stabilize the speakers and prevent them from slipping.

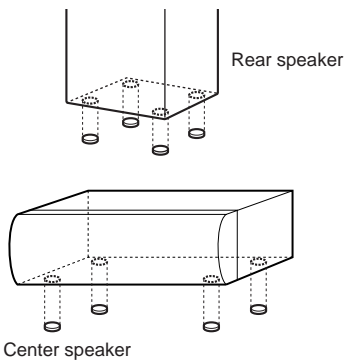

After hooking up the system, we recommend to place the system as follows:

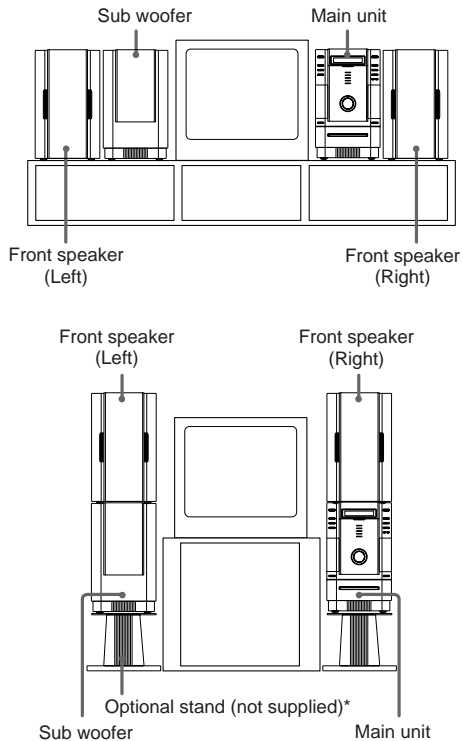

\* The optional stands are supplied for U.S.A. model.

When placing the speakers on top of the sub woofer and the main unit, be sure to place the foot of the speakers to fit in the hollows on top of the sub woofer and the main unit.

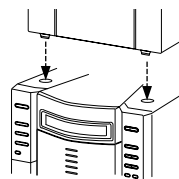

## Notes

- Keep the speaker cords away from the antennas to prevent noise.
- Do not place the rear speakers on top of a TV. This may cause color distortion in the TV screen.
- Be sure to connect both left and right rear speakers. Otherwise, the sound will not be heard.

To prevent the speakers from falling  
When you place the speakers on top of the sub woofer and the main unit, do the following.

- 1 Place the speaker support on the sub woofer and the main unit. Tighten one of the screws (①) lightly to temporarily fix the speaker support, tighten the other screw to fix (②), then tighten the first screw (①) firmly. Tighten the screws while threading the top boards of the sub woofer and the main unit.

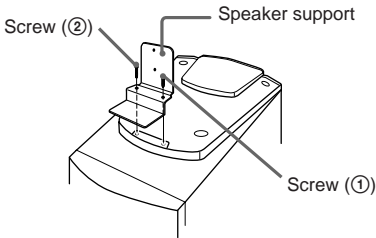

- 2 Insert the speaker support in the slot of the front speakers. Tighten two screws while threading the rear boards of the front speakers.

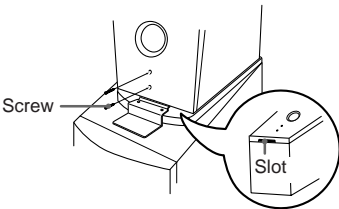

## Note

When carrying the system, do not lift the front speakers only.

## Inserting three R6 (size AA) batteries into the remote

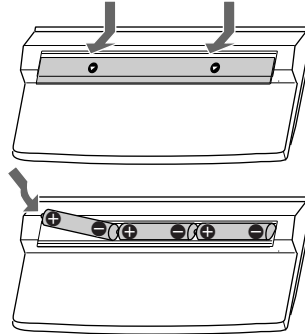

### Operating a Sony TV

You can use the following buttons on the remote to operate a Sony TV.

To	Press
Turn the TV on or off	TV I/⏻
Switch the TV's video input	TV/VIDEO.
Change the TV channels	TV CH +/-.
Adjusts the volume of the TV speaker(s)	TV VOL +/-.

## Tip

When the remote no longer operates the system, replace all the batteries with new ones.

## Note

If you do not use the remote for a long period of time, remove all the batteries to avoid possible damage from battery leakage.

**Notice for carrying this system**  
Do the following to protect the DVD mechanism.

- 1 Turn on the system, then press DVD. Make sure that all discs are removed from the unit.
- 2 Hold down DVD, then press I/⏻ until "LOCK" appears.
- 3 Release I/⏻ first, then release DVD.
- 4 Unplug the AC power cord.

## Setting up your speakers

### Positioning the speakers

For the best possible surround sound, all the speakers other than the sub woofer should be the same distance from the listening position (A).

However, if necessary, this system allows you to place the center speaker up to 1.5 meters (5 feet) closer (B) and the rear speakers up to 4.5 meters (15 feet) closer (C) to the listening position.

The front speakers can be placed from 1.0 to 12.0 meters (3 to 40 feet) (A) from the listening position.

You can place the sub woofer in any position.

You can place the rear speakers either behind you or to the side, depending on the shape of your room, etc.

When the rear speakers are placed to the side

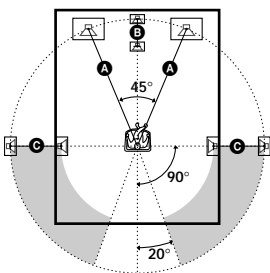

When the rear speakers are placed behind you

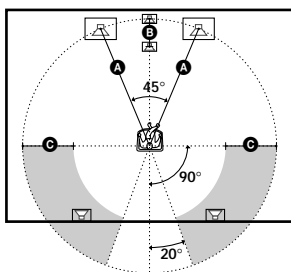

#### Note

Do not place the center and rear speakers farther away from the listening position than the front speakers.

### Specifying distance, position and height of the speakers

Use the remote for the operation.

- 1 Press **AMP MENU** repeatedly until “AMP MENU” appears.
- 2 Press **ENTER**.
- 3 Sit in your listening position and press **↑** or **↓** repeatedly to select the items to be set.
  - Adjustable items
    - Distance of the front, rear, and center speakers
    - Position and height of the rear speakers
- 4 Press **←** or **→** repeatedly to select the parameter you want.

The selected parameter appears.
- 5 Repeat steps 3 and 4 to set other parameters.

### 6 Press ENTER.

#### Tip

You can use the digipad instead of the cursor buttons (↑/↓/←/→).

#### ■ DISTANCE

You can vary the distance of each speaker as follows. The default settings are underlined.

- **FRONT 2.4 m** (8 feet) (front speakers distance)  
Front speaker distance can be set in 0.1 m (1 foot) steps from 1.0 to 12.0 m (3 to 40 feet).
- **CENTER 2.4 m** (8 feet) (center speaker distance)  
Center speaker distance can be set in 0.1 m (1 foot) steps from the front speaker distance to 1.5 m (5 feet) closer to your listening position.
- **REAR 1.5 m** (5 feet) (rear speakers distance)  
Rear speaker distance can be set in 0.1 m (1 foot) steps from a distance equal to the front speaker distance to a distance 4.5 m (15 feet) closer to your listening position.

#### Note

If each of the front or rear speakers are not placed an equal distance from your listening position, set the distance of the closest speaker.

## ■ Rear speaker position and height

Specify the position and height of the rear speakers. The default settings are underlined.

Position diagram

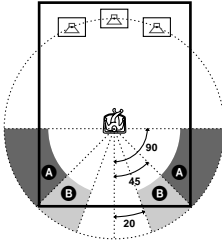

- R. PL. BEHIND  
Select this if the rear speakers are located in the section **B**.
- R. PL. SIDE  
Select this if the rear speakers are located in the section **A**.

Height diagram

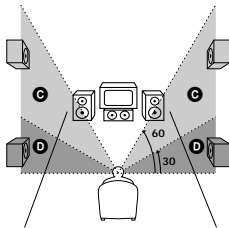

- R. HGT. LOW  
Select this if the rear speakers are located in the section **D**.
- R. HGT. HIGH  
Select this if the rear speakers are located in the section **C**.

## Specifying the speaker parameters

Use the remote for the operation.

- 1 **From your listening position, press AMP MENU.**  
Adjustable menus and parameters are described below.
- 2 **Press  $\uparrow$  or  $\downarrow$  repeatedly until “LEVEL MENU” appears.**
- 3 **Press ENTER.**
- 4 **Press  $\uparrow$  or  $\downarrow$  repeatedly to select the parameter.**
- 5 **Press  $\leftarrow$  or  $\rightarrow$  repeatedly to select the setting you want.**
- 6 **Repeat steps 4 to 5 to set other parameters.**
- 7 **Press ENTER.**

Tips

- You can use the digipad instead of the cursor buttons ( $\uparrow/\downarrow/\leftarrow/\rightarrow$ ).
- You can use “SPEAKER SETUP” in the Setup Display to specify the balance, level, and test tone parameters (page 30).

Adjustable parameters

The default settings are in the parentheses.

### ■ BALANCE

- FRNT L\_\_R: (center)  
Balance between the front left and right speakers.
- REAR L\_\_R: (center)  
Balance between the rear left and right speakers.

Range: 6 steps to the left and 6 steps to the right (13 steps)

continued

## Specifying the speaker parameters (continued)

### ■ LEVEL

- **CENTER:** (0 dB)  
Level of the center speaker (-6 dB to +6 dB, 1 dB steps).
- **REAR:** (0 dB)  
Level of the rear speakers (-6 dB to +6 dB, 1 dB steps).
- **SUB W.:** (0 dB)  
Level of the subwoofer (-6 dB to +6 dB, 1 dB steps).

### ■ D.COMP.

- **D.COMP.:** (OFF)  
Dynamic range compression.  
Range: OFF, 0.1 to 0.9, STD, MAX  
“OFF” does not compress the dynamic range.  
“0.1” to “0.9” settings allow you to compress the dynamic range in small steps. “STD” reproduces the sound track with the dynamic range intended by the recording engineer.  
“MAX” provides a great compression of the dynamic range.

### ■ TEST TONE

- **TEST TONE:** (OFF)  
Test tone output.  
Range: OFF, ON  
“ON” outputs the test tone from each speaker in sequence. Adjust the LEVEL and BALANCE parameters so that the volume level of the test tone from each speaker sounds the same using the remote from your listening position. Select “OFF” to turn off the test tone.

### Notes

- When 2.1CH/MULTI is set to “2.1CH” (page 53), you cannot set rear speaker balance, center level, rear level.
- Dynamic range compression is possible with Dolby Digital sources only.

## Setting the clock

- 1 Turn on the system.
- 2 Press **CLOCK/TIMER SET** on the remote.
- 3 Press **◀◀** or **▶▶** repeatedly to set the hour.
- 4 Press **ENTER** on the remote.
- 5 Press **◀◀** or **▶▶** repeatedly to set the minutes.
- 6 Press **ENTER** on the remote.

To adjust the clock

- 1 Press **CLOCK/TIMER SET** on the remote.
- 2 Press **◀◀** or **▶▶** repeatedly to select “CLOCK SET?”, then press **ENTER** on the remote.
- 3 Do the same procedures as step 3 to 6 above.

### Note

The clock settings are canceled when you disconnect the power cord or if a power failure occurs.



Playing discs

## Loading a disc

- 1 Press **DISC SELECT** repeatedly to select the disc tray you want to open.
- 2 Press **▲**.  
The front panel slides down and the disc tray slides out.
- 3 Place a disc with the label side up on the disc tray.

When you play a 8 cm disc, place it on the inner circle of the tray.



- 4 Press **▲** to close the disc tray.  
To insert other discs, repeat the same procedure.  
When a disc is inserted in the disc tray, the corresponding disc indicator (1 to 5 from top) lights up.

Note

When the disc tray slides out, you cannot open the cassette deck.

## Playing a disc

### — Normal Play/Shuffle Play/Repeat Play/Scan/Slow-motion Play

Before playing a DVD or a VIDEO CD, turn on your TV and select the video input. Depending on the DVD or VIDEO CD, some operations may be different or restricted. Refer to the operating instructions supplied with the disc.

Disc tray number

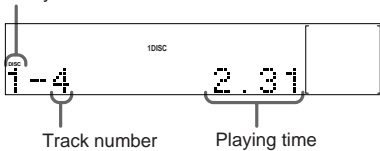

- 1 When playback is stopped, press **PLAY MODE/DIRECTION** on the remote repeatedly until the mode you want appears in the display.

Select	To play
ALL DISCS (Normal Play)	All discs in the disc tray continuously.
1 DISC (Normal Play)	The tracks on the disc you have selected in original order.
ALBUM (Normal Play)	All MP3 audio tracks in the album on the disc you have selected in original order.
ALL DISCS SHUF (Shuffle Play)	The tracks on all discs in random order.
1 DISC SHUF (Shuffle Play)	The tracks on the disc you have selected in random order.
ALBUM SHUF (Shuffle Play)	All MP3 audio tracks in the album on the disc you have selected in random order.
PGM (Program Play)	The tracks on all discs in the order you want them to be played (see "Creating your own program" on page 22).

- 2 Press **DISC SELECT** repeatedly to select the disc you want to play.
- 3 Press **◀▶**.  
If you press **◀▶** when DVD is selected as the function (press DVD) and the disc tray is closed, playback starts.

Notes

- You cannot change the play mode during playback.
- You cannot use 1 DISC SHUF or ALBUM SHUF Shuffle Play with DVDs. You can use ALL DISCS SHUF except for DVDs.

continued

## Playing a disc (continued)

### Other operations

To	Do this
Stop playback	Press <b>■</b> .
Pause playback	Press <b>⏸</b> . Press again to resume playback.
Select a track	During playback or pause, press <b>▶▶</b> (to go forward) or <b>◀◀</b> (to go back).
Find a point in a track (Lock Search function) (Except for MP3)	Press <b>▶▶</b> or <b>◀◀</b> during playback. To return to normal play, press <b>▷</b> . For DVDs, VIDEO CDs or Super Audio CDs, press <b>◀◀</b> or <b>▶▶</b> once to start searching. Press again to increase the search speed. Each time you release and press the button, the speed changes sequentially: <b>▶▶</b> : FF1 → FF2 → FF1 <b>◀◀</b> : FR1 → FR2 → FR1
Select a disc	Press D.SKIP on the remote.
Exchange other discs during playback	Press DISC SELECT repeatedly to select the disc tray that contains the disc you want to change, then press <b>▲</b> . Press <b>▲</b> again to close the tray.
Remove the disc	Press DISC SELECT repeatedly to select the disc tray that contains the disc you want to remove, then press <b>▲</b> .

To	Do this
Play repeatedly* <sup>1</sup> (Repeat Play)	Press REPEAT/FM MODE on the remote during playback until "REP" or "REP1" appears. The repeat range changes according to the play mode: • <b>ALL</b> : For all the tracks or titles on all discs up to 5 times. • <b>1 DISC</b> : For all the tracks or titles on a single disc. • <b>ALBUM</b> : For all the tracks on a single album (MP3 only). • <b>REP 1</b> : For a single title, chapter or track. You cannot use this function with certain DVDs, when playing VIDEO CDs with PBC functions. "ALL DISCS SHUF" is available only when "REP" appears. To cancel Repeat Play, press REPEAT/FM MODE on the remote until "REP" and "REP1" disappear.
Locating a point quickly in fast forward or fast reverse (scan)	During playback, press SCAN/SLOW <b>◀◀</b> or <b>▶▶</b> on the remote. To return to normal playback, press <b>◀▷</b> . For DVDs, VIDEO CDs or Super Audio CDs, two speeds are available. Each time you press the button, the indication cyclically changes as follows: Playback direction: FF 1 <b>▶▶</b> * <sup>2</sup> → FF 2 <b>▶▶</b> * <sup>2</sup> Opposite direction: FR 1 <b>◀◀</b> * <sup>2</sup> → FR 2 <b>◀◀</b> * <sup>2</sup>
Change the playback speed* <sup>3</sup> (Slow-motion play)	During pause mode, press SCAN/SLOW <b>◀◀</b> or <b>▶▶</b> on the remote. To return to normal playback, press <b>◀▷</b> . Two speeds are available. Each time you press the button, the indication cyclically changes as follows: Playback direction: SLOW 2 <b>▶▶</b> * <sup>4</sup> ↔ SLOW 1 <b>▶▶</b> * <sup>4</sup> Opposite direction (DVD only): SLOW 2 <b>◀◀</b> * <sup>4</sup> ↔ SLOW 1 <b>◀◀</b> * <sup>4</sup>

## Playing a disc with MP3 audio tracks

- \*1 You cannot select "REP1" during Program Play.
- \*2 The FF 2▶▶/FR 2◀◀ playback speed is faster than FF 1▶▶/FR 1◀◀.
- \*3 DVD and VIDEO CD only. Slow-motion reverse play for DVD only.
- \*4 The SLOW 2▶▶/SLOW 2◀◀ playback speed is slower than SLOW 1▶▶/SLOW 1◀◀.

### Tips

- You can use the digipad for the disc operations.
- Pressing DVD while the power is off automatically turns the power on.
- Depending on the disc, a menu may appear on the TV screen. You can play the disc interactively by following the instructions on the menu (see page 25 for DVD, and see page 25 for VIDEO CD).
- You can use the Control Menu to play repeatedly (page 24).

To enter track number using the remote

You can also select the track you want using the remote during Normal Play.

Press the numeric buttons, then press ENTER. The playback automatically starts.

### About MP3

MP3 (MPEG 1 Audio Layer-3) is a standard technology and format for compressing a sound sequence. The track is compressed to about 1/10 of its original size. Sounds outside the range of human hearing are compressed while the sounds we can hear are not compressed.

### Notes on discs

You can play MP3 audio tracks recorded on CD-ROMs, CD-Rs (recordable CDs), or CD-RWs (rewritable CDs).

The disc must be in the ISO 9660\* level 1, level 2 or Joliet format.

### \*ISO 9660 Format

The most common international standard for the logical format of tracks and albums on a CD-ROM. There are several specification levels. In Level 1, track names must be in the 8.3 format (no more than eight characters in the name, no more than three characters in the extension ".MP3") and in capital letters. Album names can be no longer than eight characters. There can be no more than eight nested album levels. Level 2 specifications allow album names and track names up to 31 characters long.

## Playing a disc

### — Normal Play/Shuffle Play/Repeat Play

This system lets you play the disc with MP3 audio tracks in different play modes.

Disc tray number

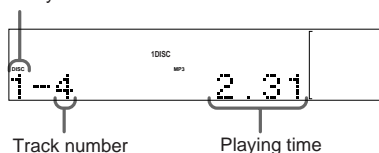

**continued**



## Playing a disc with MP3 audio tracks (continued)

- 1 Press DVD (or FUNCTION on the remote repeatedly until "DVD" appears in the display).
- 2 When playback is stopped, press PLAY MODE/DIRECTION on the remote repeatedly until the mode you want appears in the display.

Select	To play
ALL DISCS (Normal Play)	All discs in the disc tray continuously.
1 DISC (Normal Play)	The tracks on the disc you have selected in original order.
ALBUM (Normal Play)	All MP3 audio tracks in the album on the disc you have selected in original order.
ALL DISCS SHUF (Shuffle Play)	The tracks on all discs in random order.
1 DISC SHUF (Shuffle Play)	The tracks on the disc you have selected in random order.
ALBUM SHUF (Shuffle Play)	All MP3 audio tracks in the album on the disc you have selected in random order.
PGM (Program Play)	The tracks on all discs in the order you want them to be played (see "Creating your own program" on page 22).

- 3 Press DISC SELECT repeatedly to select the disc you want to play.
- 4 Press ◀▶.

## Other operations

To	Do this
Stop playback	Press ■.
Pause playback	Press II. Press again to resume playback.
Select an album of MP3 tracks	<ol style="list-style-type: none"> <li>1 Press DVD DISPLAY. The Control Menu appears in the on-screen display.</li> <li>2 Press ▲ or ▼ repeatedly to select  (ALBUM), then press ENTER or ►. The list of albums contained in the disc appears.</li> <li>3 Press ▲ or ▼ repeatedly to select an album you want to play, then press ENTER. You can select an album by pressing ◀ or ▶ while pressing SHIFT, or by pressing ALBUM + or -.</li> <li>4 Press ▲ or ▼ repeatedly to select  (TRACK), then press ENTER. The list of tracks contained in the current album appears. When the list of all tracks or albums cannot be displayed on the window, the jump bar appears. Press ► to select the jump bar icon, and then scroll the jump bar to display the rest of the list using ▲/▼.</li> <li>5 Press ▲ or ▼ repeatedly to select a track, then press ENTER.</li> </ol>
Select a track	During playback or pause, press ►► (to go forward) or ◀◀ (to go back).

To	Do this
Play repeatedly (Repeat Play)	<p>Press REPEAT/FM MODE on the remote during playback until “REP”* or “REP1” appears. The repeat range changes according to the play mode:</p> <ul style="list-style-type: none"> <li>• <b>ALL:</b> For all the tracks on all discs up to 5 times.</li> <li>• <b>1 DISC:</b> For all the tracks on a single disc up to 5 times.</li> <li>• <b>ALBUM:</b> For all the tracks on a single album up to 5 times (MP3 only).</li> <li>• <b>REP 1:</b> For a single track.</li> </ul> <p>To cancel Repeat Play, press REPEAT/FM MODE on the remote until “REP” and “REP1” disappear.</p>

\* You cannot select “REP” during ALL DISCS SHUF mode, but you can select “REP1”.

#### Tip

You can start playing from the desired track in Normal Play or Program Play. After step 1, select the album using DVD DISPLAY, then press ◀◀ or ▶▶ repeatedly until the desired track number appears.

#### Notes

- With formats other than ISO 9660 level 1, 2 and Joliet, album names or track names may not be displayed correctly.
- When naming, be sure to add the extension “.MP3” to the track name.
- If you use the extension “.MP3” to a track other than MP3, the player cannot recognize the track properly and will generate random noise that could damage your speakers.
- A disc recorded with complicated tree structure takes a longer time to start playback.
- When the disc is inserted, the player reads all the tracks on that disc. If there are many albums or non-MP3 files on the disc, it may take a long time for player to begin or for the next MP3 audio tracks to start play.
- We recommend that you do not save other types of tracks or unnecessary albums than MP3 audio tracks in the disc to be used for MP3 listening.
- An album that does not include an MP3 audio track is skipped.
- Maximum album number in a disc: 99 (The maximum number of MP3 audio tracks that can be contained on a album is 250.)
- Tracks and albums are played in the order they are recorded on the disc.
- Only the letters in the alphabet and numbers can be used for album or track names. Anything else is displayed as a space.
- ID3 tags cannot be displayed in stop mode.
- The player cannot play audio tracks in MP3PRO format.

# Creating your own program

## — Program Play

You can make a program of up to 25 tracks from all the discs in the order you want them to be played.

1 Press **DVD** when the playback is stopped.

2 Press **PLAY MODE/DIRECTION** on the remote repeatedly until **“PROGRAM”** appears in the on-screen display.

The Program Display appears on the screen.

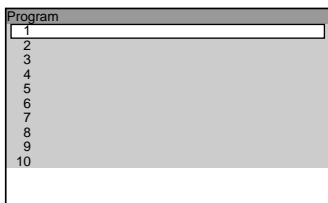

3 Press **➡**, then press **▲** or **▼** repeatedly to select the disc.

The cursor moves to the disc (in this case, **“DISC1(CD)”**).

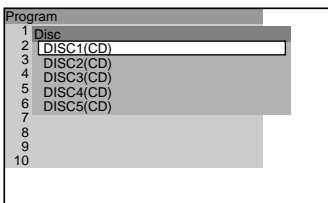

4 Press **➡**.

The cursor moves to the album or track (in this case, **“ALL TRACKS”**).

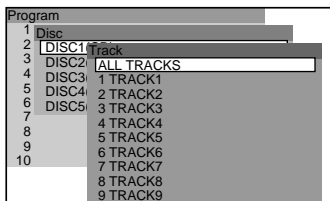

When the list of all tracks or albums cannot be displayed on the window, the jump bar appears. Press **➡** to select the jump bar icon, and then scroll the jump bar to display the rest of the list using **▲/▼**.

5 Select the album, or track you want to program.

■ When programming a **VIDEO CD** or **CD**

For example, select track **“6”**.

Press **▲/▼** or the numeric buttons to select **“6”**, then press **ENTER**.

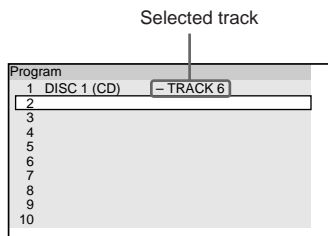

■ When programming **MP3**

For example, select track **“3”** of album **“2”**.

Press **▲/▼** to select **“2”**, then press **➡**.

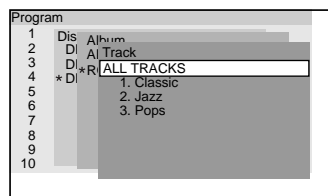

Next, press **▲/▼** or the numeric buttons to select **“3”**, then press **ENTER**.

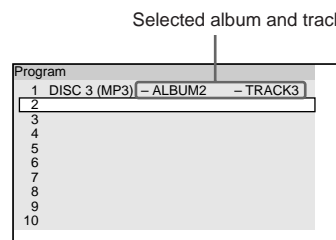

6 To program other tracks, repeat steps 3 to 5.

The programmed tracks are displayed in the selected order.

7 Press **◀▶** to start **Program Play**.

Program Play starts. When the program ends, you can restart the same program again by pressing **◀▶** on the remote.

To	Do this
Return to normal play	Press CLEAR on the remote during playback.
Turn off the program menu	In stop mode, press PLAY MODE/DIRECTION on the remote to turn off the program menu.
Clear the last programmed track	Press CLEAR in step 6. The program is cleared from the last programmed track.

#### Tips

- You can do Repeat Play of the programmed tracks. Press REPEAT/FM MODE, or set "REPEAT" to on in the Control Menu display during Program Play.
- The program you made remains in the system's memory even after it has been played back. Press ◀▶ to play the same program again.

#### Notes

- The displayed number of tracks is the same as that recorded on the disc.
- You cannot use Program Play with DVDs.

## Resuming playback from the point you stopped the disc

### — Resume Play

This system memorizes the point where you stopped the disc so you can resume from that point.

#### 1 While playing a disc, press ■ to stop playback.

"RESUME" appears in the display. If "RESUME" does not appear, Resume Play is not available.

#### 2 Press ◀▶.

The player starts playback from the point you stopped the disc in step 1.

To play from the beginning of the disc

Press ■ twice, then press ◀▶.

For a disc containing MP3 audio tracks, press ■ one more time to return to the first album.

#### Notes

- Depending on where you stopped the disc, the system may not resume playback from exactly the same point.
- Resume play is canceled when:
  - you open the disc tray.
  - you change the play mode.

## Playing repeatedly

### — Repeat Play

You can play all the titles/tracks or a single title/chapter/track on a disc.

In Shuffle or Program Play mode, the system repeats the tracks in the shuffled or programmed order.

Use the remote for the operation.

#### 1 Press DVD DISPLAY during playback.

The Control Menu appears.

#### 2 Press or repeatedly to select (REPEAT), then press ENTER.

If you do not select “OFF,” the indicator of the “REPEAT” lights in green.

#### 3 Press or repeatedly to select the Repeat Play setting.

##### ■ When playing a DVD

- OFF: does not play repeatedly.
- ALL: repeats all the titles.
- TITLE: repeats the current title.
- CHAPTER: repeats the current chapter.

##### ■ When playing a VIDEO CD/CD/Super Audio CD/MP3 and when Program Play is set to OFF

- OFF: does not play repeatedly.
- ALL: repeats all the tracks.\*
- TRACK: repeats the current track.

##### ■ When Program Play is set to ON

- OFF: does not play repeatedly.
- ALL: repeats Program Play.

\* When the play mode is set to “ALBUM” or “ALBUM SHUF”, all the tracks in the current album is repeated.

#### Notes

- When the play mode is set to “ALL DISCS SHUF”, you can select the Repeat Play of “TITLE”, “TRACK” or “CHAPTER” only.
- You can perform Repeat play for DVD titles that contain chapters.

To cancel Repeat Play

Select CLEAR on the remote.

To turn off the Control Menu

Press DVD DISPLAY repeatedly until the Control Menu is turned off.



## Playing DVDs using the menu

Some DVDs have menus to help you enjoy the DVDs. You can play DVDs using these menus.

### Using the DVD top menu

A DVD is divided into long sections of a picture or a music feature called “titles”. When you play a DVD which contains several titles, you can select the title you want using the menu.

#### 1 Press DVD TOP MENU.

The menu appears on the TV screen. The contents of the menu vary from disc to disc.

#### 2 Press $\uparrow/\downarrow/\leftarrow/\rightarrow$ or the numeric buttons on the remote to select the title you want to play.

#### 3 Press ENTER.

The playback starts from the selected title.

### Using the DVD menu

Some DVDs allow you to select the disc contents using a menu. When you play these DVDs, you can select items such as the language for the subtitles and the language for the sound using the DVD menu.

#### 1 Press DVD MENU.

The menu appears on the TV screen. The contents of the menu vary from disc to disc.

#### 2 Press $\uparrow/\downarrow/\leftarrow/\rightarrow$ or the numeric buttons on the remote to select the item you want to change.

#### 3 To change other items, repeat step 2.

#### 4 Press ENTER.

## Playing VIDEO CDs with PBC functions (Ver. 2.0)

### — PBC Play

You can use menus on your TV screen to enjoy the disc’s interactive software. The menu format and structure may differ depending on each disc.

#### 1 Press $\triangleleft/\triangleright$ to start playing a VIDEO CD with PBC functions (Ver. 2.0).

The PBC menu appears on the TV screen.

#### 2 Press $\uparrow/\downarrow$ or the numeric buttons on the remote repeatedly to select the item number you want.

#### 3 Press ENTER on the remote.

#### 4 Continue playback according to the instructions on the menus to enjoy interactive playback.

Refer to the operating instructions supplied with the disc, as the operating procedures may differ according to the VIDEO CD.

To go back to the menu

Press RETURN  $\curvearrowright$  on the remote.

To cancel playback with PBC functions

When the playback is stopped, press  $\blacktriangleleft$  or  $\blacktriangleright$ , or the numeric buttons on the remote to select a track, then press  $\triangleleft/\triangleright$ .

“Play without PBC” appears on the TV screen and playback starts from the selected track.

Still images, such as the menu screens, will not be shown.

To return to PBC playback, press  $\blacksquare$  twice, then press  $\triangleleft/\triangleright$ .

Note

Depending on the VIDEO CD, “Press ENTER” in step 3 may appear as “Press SELECT” in the operating instructions supplied with the disc. In this case, press  $\triangleleft/\triangleright$ .

## Using the Setup Display

By using the Setup Display, you can make various adjustments to items such as picture and sound. You can also set a language for the subtitles and the Setup Display, among other things. For details on each Setup Display item, see pages 27–29. For an overall list of Setup Display items, see page 75.

Items displayed on the OSD (on-screen display) vary slightly depending on the area.

Use the remote for the operation.

### 1 When the playback is stopped, press DVD SETUP.

The Setup Display appears.

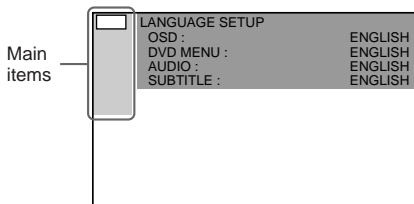

### 2 Press ↑ or ↓ repeatedly to select the setup item from the displayed list, then press ENTER.

The selected setup item appears.

Example: “SCREEN SETUP”

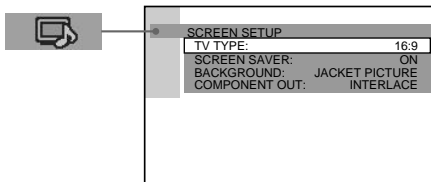

### 3 Press ↑ or ↓ repeatedly to select an item, then press ENTER.

The options for the selected item appear.

Example: “TV TYPE”

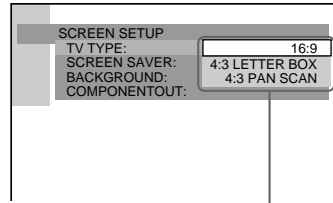

Options

### 4 Press ↑ or ↓ repeatedly to select a setting, then press ENTER.

The setting is selected and the setup is completed.

Example: “4:3 PAN SCAN”

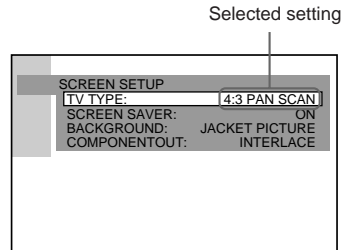

To turn off the Setup Display

Press DVD SETUP or DVD DISPLAY repeatedly until the Setup Display is turned off.

Tip

If you select “RESET” in step 2, you can reset all of the “SETUP” settings on pages 26–29 (except for PARENTAL CONTROL) to the default settings. After you select “RESET” and press ENTER, select “YES” and press ENTER to reset the settings (it takes a few seconds to complete). Do not press I/⏏ when resetting the system.

# Setting the display or sound track language

## Note

When you select a language that is not recorded on the DVD, one of the recorded languages will be automatically selected (except for “OSD”).

## — LANGUAGE SETUP

“LANGUAGE SETUP” allows you to set various languages for the on-screen display or sound track.

Select “LANGUAGE SETUP” in the Setup Display.

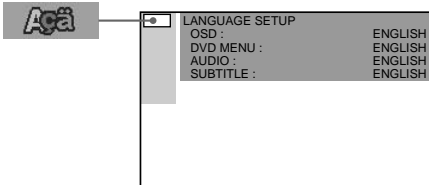

### ■ OSD (on-screen Display)

Switches the display language on the screen.  
Select the language from the displayed list.

### ■ DVD MENU (DVD only)

Select the language for the DVD menu.\*

### ■ AUDIO (DVD only)

Switches the language of the sound track.  
Select the language from the displayed list.\*

### ■ SUBTITLE (DVD only)

Switches the language of the subtitle.  
Select the language from the displayed list.\*

\* If you select “OTHERS →” in “DVD MENU”, “AUDIO”, or “SUBTITLE”, select and enter the language code from the list using the numeric buttons (page 73). After you selected, the language code (4 digits) is displayed the next time you select “OTHERS →”.

# Settings for the display

## — SCREEN SETUP

Select settings according to the connected TV.

Select “SCREEN SETUP” in the Setup Display.

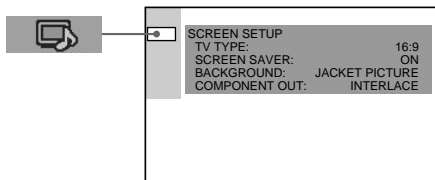

### ■ TV TYPE (DVD only)

Select the aspect ratio of the connected TV.

- **16:9:** Select this when you connect a wide-screen TV or a TV with a wide mode function.

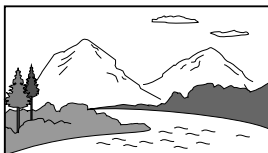

- **4:3 LETTER BOX:** Select this when you connect a 4:3 screen TV. This setting displays a wide picture with bands displayed on the upper and lower portions of the screen.

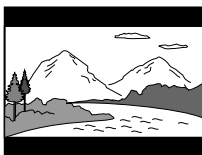

- **4:3 PAN SCAN:** Select this when you connect a 4:3 screen TV. This setting displays the wide picture on the entire screen and cuts off the portions that do not fit.

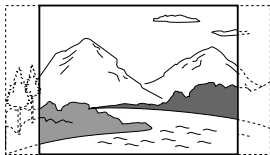

Note

Depending on the DVD, “4:3 LETTER BOX” may be selected automatically instead of “4:3 PAN SCAN” or vice versa.

### ■ SCREEN SAVER

Turn on and off the screen saver. If you turn on the screen saver, the screen saver image appears when you leave the player in pause or stop mode for 15 minutes or when you play a CD for more than 15 minutes. The screen saver will help prevent your display device from becoming damaged (ghosting). Press ◀▶ to turn off the screen saver.

- **ON:** Turns on the screen saver.
- **OFF:** Turns off the screen saver.

### ■ BACKGROUND

Select the background color or picture on the TV screen when the playback is stopped or while playing a CD.

- **JACKET PICTURE:** The jacket picture (still picture) appears in the background, but only when the jacket picture is already recorded on the disc (CD-EXTRA, etc). If the disc does not contain a jacket picture, the “GRAPHICS” picture appears.
- **GRAPHICS:** The preset picture stored in the system appears in the background.
- **BLUE:** The background color is blue.
- **BLACK:** The background color is black.

### ■ COMPONENT OUT

This will change the type of signal output from the COMPONENT VIDEO OUT jacks on the player.

- **INTERLACE:** Select this setting when you are connected to a standard (interlace format) TV.
- **PROGRESSIVE:** Select this when you have a TV that can accept progressive signals.

To force the system to switch to interlace when PROGRESSIVE is selected  
Make sure the function is set to DVD, then hold down DVD FUNCTION and press DVD MENU.

Notes

- When “PROGRESSIVE” is selected in “SCREEN SETUP” and the color system of the TV is PAL, the signal is changed into the interlace format signal automatically.
- When “PROGRESSIVE” is selected in “SCREEN SETUP,” no signal is output from the VIDEO OUT or S VIDEO OUT jacks.

# Custom settings

## — CUSTOM SETUP

Select “CUSTOM SETUP” in the Setup Display.

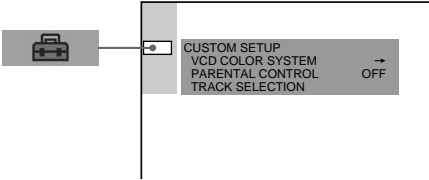

### ■ COLOR SYSTEM (Except for Pan American and European model)

Select the color system when you play a VIDEO CD.

- AUTO: Outputs the video signal in the system of the disc, either PAL or NTSC. If your TV uses a DUAL system, select AUTO.
- PAL: Changes the video signal of an NTSC disc and outputs it in the PAL system.
- NTSC: Changes the video signal of a PAL disc and outputs it in the NTSC system.

#### Note

You cannot change the color system of the disc itself.

### ■ PARENTAL CONTROL (DVD only)

Set a password and playback limitation level for DVDs with playback limitation for children. For details, see “Limiting playback by children (Parental Control)” on page 38.

### ■ TRACK SELECTION (DVD only)

Gives the priority to the sound track which contains the highest number of channels when you play a DVD on which multiple audio formats (PCM, DTS, or Dolby Digital format) are recorded.

- OFF: No priority given.
- AUTO: Priority given.

#### Notes

- When you set to “AUTO”, the language setting may change. The “TRACK SELECTION” setting has higher priority than the “AUDIO” setting in “LANGUAGE SETUP” (page 27).
- If PCM, DTS, and Dolby Digital sound tracks have the same number of channels, the system selects PCM, DTS, and Dolby Digital sound tracks in this order.
- Depending on the DVD, the audio channel with priority may be predetermined. In this case, you cannot give priority to the DTS, or Dolby Digital audio format by selecting “AUTO”.

# Speaker settings

## — SPEAKER SETUP

Select “SPEAKER SETUP” in the Setup Display.

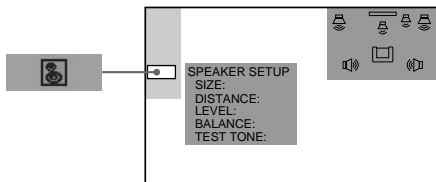

To return to the default setting  
Select the item, then press CLEAR.

### ■ SIZE

When you move the rear speakers, set the parameters for REAR. Since the front speaker and subwoofer settings are fixed, you cannot change them. The default settings are underlined.

- FRONT  
— YES
- CENTER  
— YES
- REAR  
— BEHIND (LOW), BEHIND (HIGH), SIDE (LOW), SIDE (HIGH): Specify the position and height (see page 14).

#### Notes

- When you select an item, the sound cuts off for a moment.
- Depending on the settings of other speakers, the subwoofer may output excessive sound.

### ■ DISTANCE

The default distance settings for the speakers in relation to the listening position is shown below.

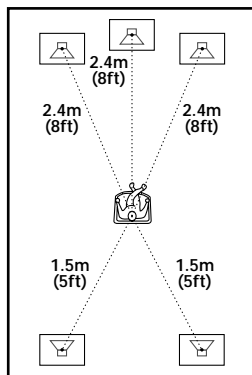

Be sure to change the value in the Setup Display when you move the speakers.

- FRONT: Front speaker distance from the listening position can be set in 0.1 meter steps from 1.0 to 12.0 meters (or in 1 foot steps from 3 to 40 feet).
- CENTER: Center speaker distance can be moved up to 1.5 meters (5 feet) closer to the listening position, from the front speakers in 0.1 meter steps (or in 1 foot steps).
- REAR: Rear speaker distance can be moved up to 4.5 meters (15 feet) closer to the listening position, from the front speakers in 0.1 meter steps (or in 1 foot steps).

#### Notes

- When you select an item, the sound cuts off for a moment.
- If each of the front or rear speakers is not placed at an equal distance from your listening position, set the distance of the closest speaker.
- Do not place the rear speakers farther away from your listening position than the front speakers.

## ■ BALANCE

You can vary the balance of the left and right speakers as follows. Be sure to set “TEST TONE” to “ON” for easy adjustment.

- **FRONT (CENTER)**: Adjust the balance between the front left and right speakers (You can adjust in 6 steps to left or right from center position).
- **REAR (CENTER)**: Adjust the balance between the rear left and right speakers (You can adjust in 6 steps to left or right from center position).

## ■ LEVEL

You can vary the level of each speakers as follows. Be sure to set “TEST TONE” to “ON” for easy adjustment.

- **CENTER (0 dB)**: Adjust the level of the center speaker (–6 dB to +6 dB, 1 dB steps).
- **REAR (0 dB)**: Adjust the level of the rear speakers (–6 dB to +6 dB, 1 dB steps).
- **SUBWOOFER (0 dB)**: Adjust the level of the subwoofer (–6 dB to +6 dB, 1 dB steps).

## ■ TEST TONE

The speakers will emit a test tone to adjust “BALANCE” and “LEVEL”.

- **OFF**: The test tone is not emitted from the speakers.
- **ON**: The test tone is emitted from each speaker in sequence while adjusting balance or level. When you select one of the “SPEAKER SETUP” items, the test tone is emitted from both left and right speakers simultaneously.

To adjust the volume of all the speakers at once

Turn **VOLUME** (or press **VOLUME +/-** on the remote).

## Adjusting the speaker volume and level

- 1 **Press DVD SETUP in stop mode, then select “SPEAKER SETUP”.**
- 2 **Select “TEST TONE” and set “TEST TONE” to “ON”.**  
You will hear the test tone from each speaker in sequence.
- 3 **From your listening position, select “BALANCE” or “LEVEL”, then press ◀ or ▶ repeatedly to adjust the value of “BALANCE”, or press ▲ or ▼ repeatedly to adjust the value of “LEVEL”.**  
The test tone is emitted from both left and right speakers simultaneously.
- 4 **Select “TEST TONE” and set “TEST TONE” to “OFF” to turn off the test tone.**

### Notes

- When you adjust the speaker settings, the sound cuts off for a moment.
- If you adjust these parameters using OSD while adjusting the speaker parameters using AMP MENU or SPEAKER LEVEL (pages 14–16), the display on the unit turns off.

## Checking the playing time and remaining time

You can check the playing time and remaining time of the current title, chapter, or track, and the total playing time of the disc on the screen.

Use the remote for the operation.

### 1 Press DVD DISPLAY during playback.

The Control Menu appears.

### 2 Press DISPLAY repeatedly to change the time information.

The display and the kinds of time that you can change depend on the disc you are playing.

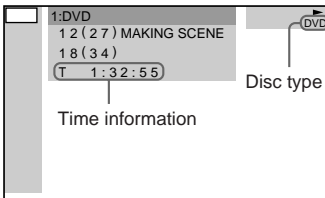

#### ■ When playing a DVD

- T \*\*:\*\*\*:\*\*\*  
Playing time of the current title
- T-\*\*\*:\*\*\*:\*\*\*  
Remaining time of the current title
- C \*\*:\*\*\*:\*\*\*  
Playing time of the current chapter
- C-\*\*\*:\*\*\*:\*\*\*  
Remaining time of the current chapter

#### ■ When playing a VIDEO CD (with PBC functions)

- \*\*:\*\*\*  
Playing time of the current scene

#### ■ When playing a VIDEO CD (without PBC functions) or CD

- T \*\*:\*\*\*  
Playing time of the current track
- T-\*\*\*:\*\*\*  
Remaining time of the current track
- D \*\*:\*\*\*  
Playing time of the current disc
- D-\*\*\*:\*\*\*  
Remaining time of the current disc

#### ■ When playing an MP3 file

- T \*\*:\*\*\*  
Playing time of the current track
- T-\*\*\*:\*\*\*  
Remaining time of the current track

To turn off the Control Menu  
Press DVD DISPLAY repeatedly until the  
Control Menu is turned off.



## Changing the sound

If a DVD is recorded with multilingual tracks, you can select the language you want while playing the DVD. If the DVD is recorded in multiple audio formats, you can select the audio format you want while playing the DVD.

With stereo CDs or VIDEO CDs, you can select the sound from the right or left channel and listen to the sound of the selected channel through both the right and left speakers. (In this case, the sound loses its stereo effect.) For example, when playing a disc containing a song with the vocals on the right channel and the instruments on the left channel, you can select the left channel and hear only the instruments from both speakers.

Use the remote for the operation.

### 1 Press DVD DISPLAY during playback.

The Control Menu appears.

### 2 Press $\uparrow$ or $\downarrow$ repeatedly to select "AUDIO", then press ENTER.

The options for "AUDIO" appear.

### 3 Press $\uparrow$ or $\downarrow$ repeatedly to select the audio signal you want.

#### ■ When playing a DVD

Depending on the DVD, the choice of the language varies. When 4 digits are displayed, they represent the language code (see the language code list on page 73). When the same language is displayed twice or more, the DVD is recorded in multiple audio formats.

#### ■ When playing a VIDEO CD or CD

- STEREO: The standard stereo sound.
- 1/L: The sound of the left channel (monaural).
- 2/R: The sound of the right channel (monaural).

The default setting is "STEREO".

#### Note

Excessive noise or momentary silence may be heard from the speakers if you select 1/L or 2/R when playing DTS format CDs.

#### ■ When playing a Super Audio CD

In stop mode, depending on the Super Audio CD, the choice of settings varies.

- MULTI: The disc has multi-channel playback area
- 2CH: The disc has the 2 channel playback area.
- CD: When you want to play the disc as a conventional CD.

#### Note

Not all discs give you the three choices above when in Super Audio CD playback. It all depends on the layer configuration of the Super Audio CD to be played.

## 4 Press ENTER.

To turn off the Control Menu

Press DVD DISPLAY repeatedly until the Control Menu is turned off.

#### Tip

You can select the audio setting by pressing AUDIO. Each time you press the button, the setting changes.

#### Notes

- For discs not recorded in multiple audio format, you cannot change the sound.
- Depending on the DVD, you may not be able to change the sound even if the DVD is recorded in multiple audio format.
- For VIDEO CDs and CDs, the setting returns to "STEREO" when you turn off the system or open the disc tray.
- During DVD playback, the sound may change automatically.

**continued**

## Changing the sound (continued)

### Displaying the audio information of the disc

(DVD only)

When you select "AUDIO", the channels being played are displayed on the screen.

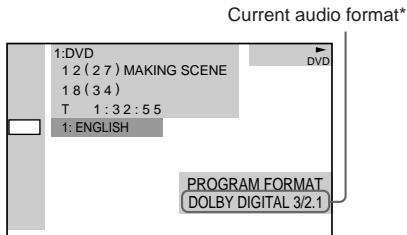

\* "PCM", "DTS", or "DOLBY DIGITAL" is displayed.

For "DOLBY DIGITAL", the channels in the playing track are displayed numerically as follows:

For Dolby Digital 5.1 ch:

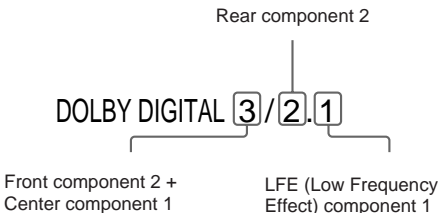

The display examples are as follows:

- PCM (stereo)

PROGRAM FORMAT  
PCM 48kHz 24bit

- Dolby Surround

PROGRAM FORMAT  
DOLBY DIGITAL 2/0  
DOLBY SURROUND

- Dolby Digital 5.1ch

PROGRAM FORMAT  
DOLBY DIGITAL 3/2.1

- DTS

PROGRAM FORMAT  
DTS 3/2.1

## Searching for a title/ chapter/track/index

You can search a title (DVD), chapter (DVD), track (CD, VIDEO CD, Super Audio CD, MP3), index (VIDEO CD, Super Audio CD), and album (MP3). As titles, tracks and albums are assigned unique names on the disc, you can select the desired one from the Control Menu. Also chapters and indexes are assigned unique numbers on the disc, so you select the desired one by entering its number. Or you can search a particular point using the time code (TIME SEARCH).

Use the remote for the operation.

### 1 Press DVD DISPLAY.

The Control Menu appears.



### 2 Press **▲** or **▼** repeatedly to select the search method.

#### ■ When playing a DVD



 (TITLE),  (CHAPTER), or  (TIME)

Select TIME for TIME SEARCH.



#### ■ When playing a Super Audio CD

 (TRACK),  (INDEX), or  (TIME)



#### ■ When playing a VIDEO CD (PBC OFF)

 (TRACK),  (INDEX), or  (TIME)

#### ■ When playing a CD

 (TRACK) or  (TIME)

#### ■ When playing an MP3

 (TRACK),  (ALBUM), or  (TIME)

### 3 Press ENTER.

“\*\* (\*\*)” changes to “-- (\*\*)”.

The number in parentheses indicates the total number of titles, chapters, tracks, or indexes.

### 4 Press **▲** or **▼** repeatedly, or press the numeric buttons to select the title, chapter, track, or index number you want to search.

#### If you make a mistake

Press CLEAR to cancel the number, then select another number.

### 5 Press ENTER.

The playback starts from the selected number.

To search for a scene using the time code (TIME SEARCH)

### 1 In step 2, select “TIME”.

“T \*\*:\*\*:\*\*” (playing time of the current title) is selected.

### 2 Press ENTER.

“T \*\*:\*\*:\*\*” changes to “--:--:--”.

### 3 Input the time code using the numeric buttons, then press ENTER.

For example, to find the scene at 2 hours, 10 minutes, and 20 seconds after the beginning, just enter “2:10:20”.

To cancel

Press RETURN .

To turn off the Control Menu

Press DVD DISPLAY repeatedly until the Control Menu is turned off.

#### Notes

- The displayed number of titles, chapters, or tracks is the same as that recorded on the disc.
- When playing a VIDEO CD with PBC functions, index number does not appear.
- Time search and Index search cannot be used during PBC playback of Video CDs.
- When the chapter number does not appear, you cannot search the disc by chapter.
- The number in parentheses does not appear when it is 100 or more.

## Changing the angles



(DVD only)

When playing a DVD on which various angles (multi-angles) for a scene are recorded, the “ANGLE” indicator lights in green. This means that you can change the viewing angle. For example, while playing a scene of a train in motion, you can display the view from either the front of the train, the left window of the train or from the right window without having the train’s movement interrupted.

Use the remote for the operation.

**1 Press DVD DISPLAY during playback.**



The Control Menu appears.

**2 Press  or  repeatedly to select  (ANGLE).**

The angle number appears. The number in parentheses indicates the total number of angles.

**3 Press  or ENTER.**

The angle number changes to “–”.

**4 Select the angle you want using the numeric buttons or /, then press ENTER.**

The angle is changed to the selected angle.

To turn off the Control Menu

Press DVD DISPLAY repeatedly until the Control Menu is turned off.

Tip

You can select the angle by pressing ANGLE. Each time you press the button, the angle changes.

Note

Depending on the DVD, you may not be able to change the angles even if multi-angles are recorded on the DVD.

## Displaying the subtitles

(DVD only)

With DVDs on which multilingual subtitles are recorded, you can change the subtitle language while playing a DVD, or turn the subtitles on or off whenever you want. For example, you can select the language you want to master and turn the subtitles on for better understanding.



Use the remote for the operation.

**1 Press DVD DISPLAY during playback.**

The Control Menu appears.

**2 Press  or  repeatedly to select  (SUBTITLE), then press ENTER.**

The options for “SUBTITLE” appear.

**3 Press  or  repeatedly to select the language you want, then press ENTER.**

The subtitles are displayed in the selected language.

To cancel the SUBTITLE setting  
Select “OFF” in step 3.

To turn off the Control Menu  
Press DVD DISPLAY repeatedly until the Control Menu is turned off.

Tip

You can select the subtitle by pressing SUBTITLE. Each time you press the button, the language changes.

Notes

- When 4 digits are displayed in step 3, they indicate the language code. Refer to the language code list on page 73 to see the language the code represents.
- Depending on the DVD, you may not be able to change the subtitles even if multilingual subtitles are recorded on the DVD.

## Locking discs

### — CUSTOM PARENTAL CONTROL/ PARENTAL CONTROL

You can set two kinds of playback restrictions for the disc.

- Custom Parental Control

You can set the playback restrictions so that the system will not play inappropriate discs. You can set the same Custom Parental Control password for up to 25 discs. When you set the 26th disc, the playback restriction for the first disc is canceled.

- Parental Control

You can limit the playback of some DVDs according to a predetermined level such as the age of the users. The limited scene is not played, or replaced by a different scene.

The same password is used for both Custom Parental Control and Parental Control.

Use the remote for the operation.

### Custom Parental Control

**1 Insert the disc you want to lock.**

If the disc is playing, press **■** to stop playback.

**2 When the playback is stopped, press DVD DISPLAY.**

The Control Menu appears.

**3 Press **▲** or **▼** repeatedly to select “CUSTOM PARENTAL CONTROL”, then press ENTER.**

“CUSTOM PARENTAL CONTROL” is selected.

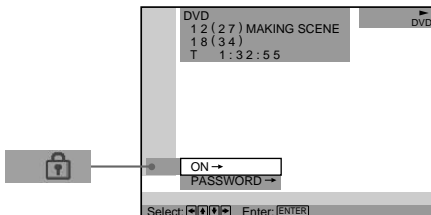

**4 Press **▲** or **▼** repeatedly to select “ON ->”, then press ENTER.**

**■ If you have not entered a password**

The display for registering a new password appears.

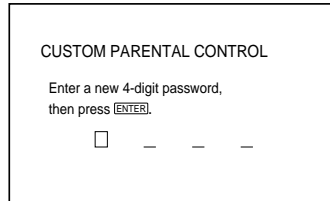

Enter a 4-digit password using the numeric buttons, then press ENTER.

The display for confirming the password appears.

**■ When you have already registered a password**

The display for entering the password appears.

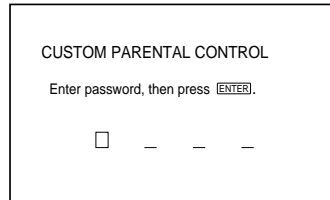

**5 Enter or re-enter your 4-digit password using the numeric buttons, then press ENTER.**

“Custom parental control is set.” appears and the screen returns to the Control Menu Display.

**If you make a mistake entering your password**

Press **◀** before you press ENTER and input the correct number.

continued

## Locking discs (continued)

If you make a mistake

Press RETURN , then start from step 3 again.

To turn off the Control Menu

Press RETURN , then press DVD DISPLAY repeatedly until the Control Menu is turned off.

To turn off the Custom Parental Control function

- 1 In step 4, select “OFF →”, then press ENTER.
- 2 Enter your 4-digit password using the numeric buttons, then press ENTER.

To change the password

- 1 In step 4, select “PASSWORD →”, then press ENTER.  
The display for entering the password appears.
- 2 Enter your 4-digit password using the numeric buttons, then press ENTER.
- 3 Enter a new 4-digit password using the numeric buttons, then press ENTER.
- 4 To confirm your password, re-enter it using the numeric buttons, then press ENTER.

Playing the disc for which Custom Parental Control is set

- 1 **Insert the disc for which Custom Parental Control is set.**  
The “CUSTOM PARENTAL CONTROL” display appears.
- 2 **Enter your 4-digit password using the numeric buttons, then press ENTER.**  
The system is ready for playback.

Tip

If you forgot your password, enter the 6-digit number “199703” using the numeric buttons when the “CUSTOM PARENTAL CONTROL” display asks you for your password, then press ENTER. The display will ask you to enter a new 4-digit password.

## Limiting playback by children (Parental Control)

(DVD only)

- 1 **When the playback is stopped, press DVD SETUP.**  
The Setup Display appears.
- 2 **Press ↑ or ↓ repeatedly to select “CUSTOM SETUP”, then press ENTER.**  
The “CUSTOM SETUP” display appears.

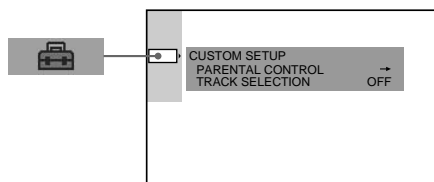

- 3 **Press ↑ or ↓ repeatedly to select “PARENTAL CONTROL →”, then press ENTER.**

### ■ If you have not entered a password

The display for registering a new password appears.

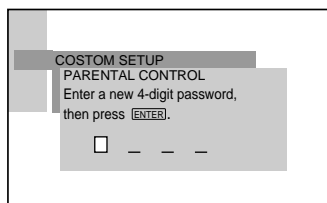

Enter a 4-digit password using the numeric buttons, then press ENTER.

The display for confirming the password appears.

■ **When you have already registered a password**

The display for entering the password appears.

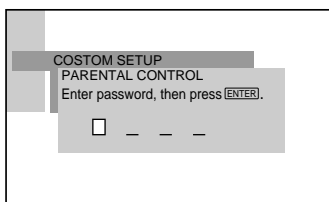

**4 Enter or re-enter your 4-digit password using the numeric buttons, then press ENTER.**

The display for setting the playback limitation level and changing the password appears.

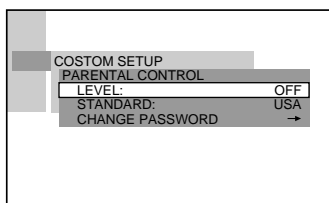

**5 Press ↑ or ↓ repeatedly to select “STANDARD”, then press ENTER.**

The options for “STANDARD” appears.

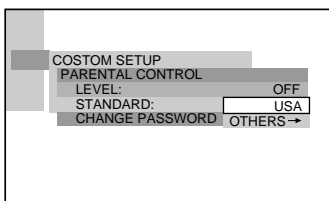

**6 Press ↑ or ↓ repeatedly to select a geographic area as the playback limitation level, then press ENTER.**

The area is selected.

When you select “OTHERS →”, select and enter the standard code in the table on page 40 using the numeric buttons.

**7 Press ENTER.**

The options for “LEVEL” appears.

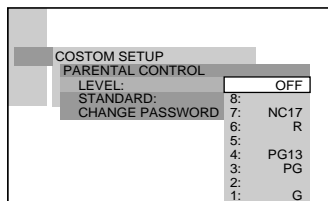

**8 Press ↑ or ↓ repeatedly to select the level you want, then press ENTER.**

The Parental Control setting is completed.

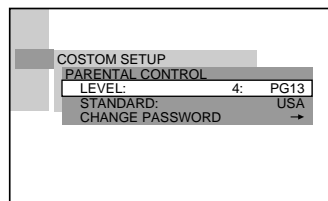

The lower the value, the more strict the limitation.

If you make a mistake

Press RETURN  to go back to the previous screen.

To turn off the Control Menu

Press DVD DISPLAY repeatedly until the Control Menu is turned off.

continued

## Locking discs (continued)

To turn off the Parental Control function and play the DVD after entering your password Set “LEVEL” to “OFF” in step 8.

To change the password

- 1 In step 5, press  $\blacktriangledown$  to select “CHANGE PASSWORD  $\rightarrow$ ”, then press ENTER. The display for entering the password appears.
- 2 Follow step 3 to enter a new password.

Playing the disc for which Parental Control is set

- 1 **Insert the disc and press  $\triangleleft \triangleright$ .**  
The “PARENTAL CONTROL” display appears.
- 2 **Enter your 4-digit password using the numeric buttons, then press ENTER.**  
The playback starts.

Tip

If you forgot your password, remove the disc and repeat steps 1 to 3 of “Limiting playback by children”. When you are asked to enter your password, enter “199703” using the numeric buttons, then press ENTER. The display will ask you to enter a new 4-digit password. After you enter a new 4-digit password, replace the disc in the system and press  $\triangleleft \triangleright$ . When the “PARENTAL CONTROL” display appears, enter your new password.

Notes

- When you play DVDs which do not have the Parental Control function, playback cannot be limited on this system.
- Depending on the DVD, you may be asked to change the parental control level while playing the disc. In this case, enter your password, then change the level.

Area code

Standard	Code number	Standard	Code number
Argentina	2044	Korea	2304
Australia	2047	Malaysia	2363
Austria	2046	Mexico	2362
Belgium	2057	Netherlands	2376
Brazil	2070	New Zealand	2390
Canada	2079	Norway	2379
Chile	2090	Pakistan	2427
China	2092	Philippines	2424
Denmark	2115	Portugal	2436
Finland	2165	Russia	2489
France	2174	Singapore	2501
Germany	2109	Spain	2149
Hong Kong	2219	Sweden	2499
India	2248	Switzerland	2086
Indonesia	2238	Taiwan	2543
Italy	2254	Thailand	2528
Japan	2276	United Kingdom	2184



## Presetting radio stations

You can preset up to 20 FM stations and 10 AM stations. You can then tune in any of those stations simply by selecting the corresponding preset number.

There are two ways to store the station presets.

To	Method
Automatically tune in all of the stations that can be received in your area and then store them manually	Automatic Tuning Preset
Manually tune in and store the radio frequency of your favorite stations	Manual Tuning Preset

### Setting presets through automatic tuning

- 1 Press **TUNER/BAND** repeatedly to select **FM** or **AM**.
- 2 Press and hold **◀◀** or **▶▶** until the frequency indication starts to change, then release.

The frequency changes as the system scans for a station. Scanning stops automatically when a station is tuned in. At that time, “TUNED” and “STEREO” (for stereo program only) appear.

**If “TUNED” does not appear and the scanning does not stop**

Set the frequency of the desired radio station as described in steps 2 through 4 of “Setting presets through manual tuning”.

- 3 Press **TUNER MEMORY** on the remote.

A preset number appears in the display. The stations are stored from preset number 1.

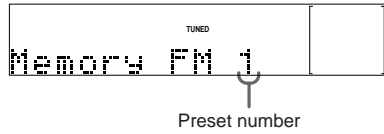

- 4 Press **ENTER** on the remote. The station is stored.
- 5 Repeat steps 2 through 4 to preset other stations.

### Setting presets through manual tuning

- 1 Press **TUNER/BAND** repeatedly to select **FM** or **AM**.
- 2 Press **◀◀** or **▶▶** repeatedly to tune in the desired station.
- 3 Press **TUNER MEMORY** on the remote. A preset number appears in the display. The stations are stored from preset number 1.

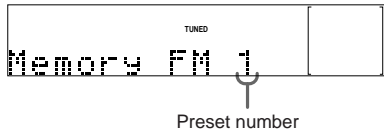

- 4 Press **ENTER** on the remote. The station is stored.
- 5 Repeat steps 2 through 4 to preset other stations.

continued

## Presetting radio stations (continued)

### Other Operations

To	Do this
Tune in a station with a weak signal	Follow the procedure described in “Setting presets through manual tuning”.
To set another station to an existing preset number	Start over from step 1. After step 3, press <b>◀◀</b> or <b>▶▶</b> repeatedly to select the preset number where you want to store a new station, then proceed to step 4.

To change the AM tuning interval (Except for the European and Middle Eastern models)

The AM tuning interval is factory-preset to 9 kHz (or 10 kHz for some areas). To change the AM tuning interval, tune in any AM station first, then turn off the system. While holding down **▶▶** and **I/⏻**, turn the system back on. When you change the interval, all the AM preset stations are erased. To reset the interval, repeat the same procedure.

#### Note

You cannot change the AM tuning interval in the Power Saving Mode.

#### Tips

- Pressing **TUNER/BAND** while the power is off automatically turns the power on.
- The preset stations are retained for half a day even if you unplug the power cord or if a power failure occurs.
- To improve the reception, adjust the supplied antennas or connect an external antenna.

## Listening to the radio

You can listen to a radio station either by selecting a preset station, or by manually tuning in the station.

### Listening to a preset station

#### — *Preset Tuning*

Preset radio stations in the tuner’s memory first (see “Presetting radio stations” on page 41).

- 1 Press **TUNER/BAND** repeatedly to select **FM** or **AM**.
- 2 Press **◀◀** or **▶▶** repeatedly to select the desired preset station.

To select the desired preset number using the numeric buttons on the remote

Press numeric buttons instead of performing step 2.

To enter preset number 10 or higher, press **>10** and the corresponding numeric buttons. To enter 0, press **10/0**.

Example:

To enter preset number 20, press **>10**, then **2** and **10/0**.

### Listening to non-preset radio station

#### — *Manual Tuning*

- 1 Press **TUNER/BAND** repeatedly to select **FM** or **AM**.
- 2 Press **◀◀** or **▶▶** repeatedly to tune in the desired station.

Tips

- To improve broadcast reception, reorient the antennas.
- When an FM stereo programme has static noise, press **REPEAT/FM MODE** on the remote repeatedly until “**MONO**” appears. There will be no stereo effect, but the reception will improve.
- Press and hold **◀◀** or **▶▶** in step 2 above. The frequency indication changes and scanning stops when the system tunes in a station (Automatic Tuning).

## Using the Radio Data System (RDS)

(European model only)

### What is the Radio Data System?

Radio Data System (RDS) is a broadcasting service that allows radio stations to send additional information along with the regular program signal. RDS is available only on FM stations.\*

#### Note

RDS may not work properly if the station you are tuned in is not transmitting the RDS signal properly or if the signal is weak.

\* Not all FM stations provide RDS service, nor do they provide the same types of services. If you are not familiar with the RDS system, check with your local radio stations for details on RDS services in your area.

### Receiving RDS broadcasts

#### **Simply select a station from the FM band.**

When you tune in a station that provides RDS services, the station name appears in the display.

To check the RDS information

Each time you press DISPLAY on the remote, the display changes cyclically as follows:

Station name\* → Frequency → Program type\*\* → Clock display → Effect status

\* If the RDS broadcast is not properly received, the station name may not appear in the display.

\*\* The types of programs include, NEWS, AFFAIRS (current news), INFO, SPORT, EDUCATE (education programs), DRAMA, CULTURE, SCIENCE, VARIED (interviews, games and comedy), POP M, ROCK M, EASY M, LIGHT M, CLASSICS, OTHER M, WEATHER, FINANCE, CHILDREN, SOCIAL, RELIGION, PHONE IN, TRAVEL, LEISURE, JAZZ, COUNTRY (country music), NATION M (nation's popular music), OLDIES, FOLK M, DOCUMENT (investigative features), TEST (test signal for emergency broadcast), ALARM (emergency broadcast) and NONE (any program not defined above).

## Loading a tape

- 1 Press **▲ A** or **▲ B**.
- 2 Insert a tape in deck A or B.

Insert with the side you want to play/record facing forward.

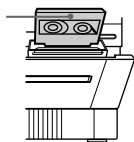

### Note

When the cassette deck is open, the disc tray does not slide out.

## Playing a tape

You can use TYPE I (normal) tapes.

- 1 Load a tape.
- 2 Press **TAPE A/B** repeatedly to select deck A or B.
- 3 Press **PLAY MODE/DIRECTION** on the remote repeatedly to select **⇌** to play one side, **↔** to play both sides, or **RELAY\*** (Relay Play) to play both decks in succession.
- 4 Press **◀▶**.

The tape starts playing.

Press **◀▶** again to play the reverse side.

When you select **↔** or **RELAY**, the deck stops automatically after repeating the sequence 5 times.

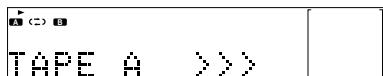

\* Relay Play always follow this cyclic sequence:  
Deck A (front side) → Deck A (reverse side) →  
Deck B (front side) → Deck B (reverse side) →

To	Do this
Stop playback	Press <b>■</b> .
Pause playback	Press <b>⏸</b> . Press again to resume playback.
Fast-forward	Press <b>⏩</b> while playing the front side or press <b>◀◀</b> while playing the reverse side.
Rewind	Press <b>◀◀</b> while playing the front side or press <b>⏩</b> while playing the reverse side.

### Tips

- You can use the digipad for tape operations.
- Pressing **TAPE A/B** while the power is off automatically turns the power on.

Searching for the beginning of a track (AMS\*)

During playback, press **⏮** or **⏭** repeatedly for the number of songs you want to skip forward (or backward).

The search direction, + (forward) or - (back), and number of songs being skipped (1-9) appear in the display.

Example: searching forward 2 songs

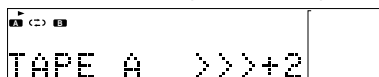

\* Automatic Music Sensor

### Note

The AMS function may not operate correctly under the following circumstances:

- When the unrecorded space between songs is less than 4 seconds long.

# Recording to a tape

## — CD Synchro Recording/High-Speed Dubbing/Recording Manually/Program Edit

You can record from a disc, tape (or connected components) or radio. You can use TYPE I (normal) tapes.

Steps	Recording from a VIDEO CD/CD/Super Audio CD/MP3 file (CD Synchro Recording)	Recording from a tape (High-Speed Dubbing)	Recording Manually
1	Insert a recordable tape into deck B.		
2	Press DVD.	Press TAPE A/B repeatedly to select TAPE A function.	Press a function button for the recording source.
3	Insert the disc you want to record.	Insert the tape you want to record into deck A.	Load the disc/tape (or other audio source), or tune in the station you want to record.
4	Press CD SYNC HI-DUB.		Press REC PAUSE/START.
	Deck B stands by for recording. “REC” flashes.		
5	Press PLAY MODE/DIRECTION on the remote repeatedly to select $\rightleftarrows$ to record on one side. Select $\leftrightarrow$ (or RELAY) to record on both sides.		
6	Press REC PAUSE/START. Recording starts.		
7			Start playing the recording source.

Tape

To	Press
Stop recording	■.
Pause recording*	REC PAUSE/START.

\* Only when recording manually.

### Tips

- If you want to record from the reverse side, press TAPE A/B to select deck B and press  $\triangleleft \triangleright$  to start playback of the reverse side after step 1. Press ■ where you want to start recording.
- When you record on both sides, be sure to start from the front side. If you start from the reverse side, recording stops at the end of the reverse side.
- (High-Speed Dubbing only)  
If you set direction to  $\leftrightarrow$  when the tapes have different lengths, the tapes in each deck reverses independently. If you select RELAY, the tapes in both decks reverse together.

### Notes

- You cannot open the disc tray and the cassette deck at the same time.
- You cannot listen to other sources while recording.
- You cannot use the digipad during recording.
- If you start recording with 2.1CH/MULTI set to MULTI mode, the setting automatically changes to 2.1CH mode in step 4.

continued

## Recording to a tape (continued)

Recording a VIDEO CD/CD/  
Super Audio CD/MP3 by  
specifying track order

### — Program Edit

When programming, make sure the playing times for each side do not exceed the length of one side of the tape.

- 1 Insert a recordable tape into deck B, then press DVD when playback is stopped.
- 2 Press PLAY MODE/DIRECTION on the remote repeatedly until “PROGRAM” appears in the on-screen display.  
The Program Display appears on the screen.

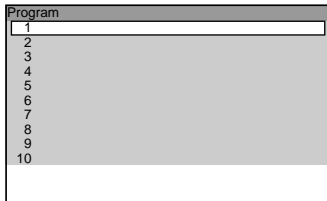

- 3 Press →, then press ↑ or ↓ repeatedly to select the disc.  
The cursor or moves to the disc (in this case, “DISC1(CD)”).

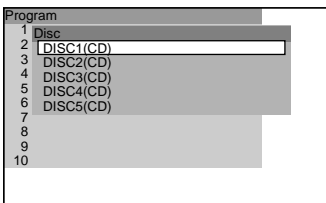

- 4 Press →.  
The cursor moves to the album or track (in this case, “ALL TRACKS”).

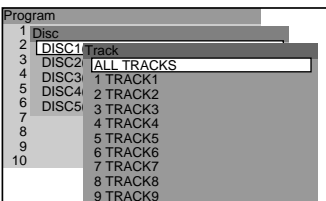

- 5 Select the album, or track you want to program.

### ■ When programming a VIDEO CD or CD

For example, select track “6”.

Press ↑/↓ or the numeric buttons to select “6”, then press ENTER.

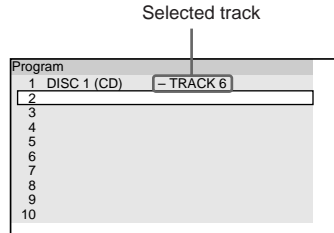

### ■ When programming MP3

For example, select track “3” of album “2”.

Press ↑/↓ or the numeric buttons to select “2”, then press →.

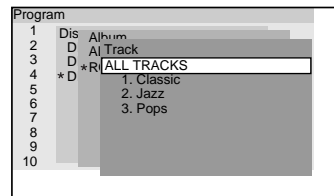

Next, press ↑/↓ or the numeric buttons to select “3”, then press ENTER.

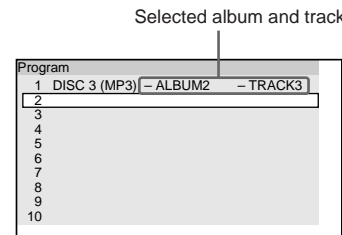

- 6 To program additional tracks, repeat steps 3 to 5.  
Skip step 3 to select tracks from the same disc.

## 7 Press CD SYNC HI-DUB.

“REC” flashes, and “SYNC” appears in the display.

## 8 Press PLAY MODE/DIRECTION on the remote repeatedly to select $\rightleftarrows$ to record on one side.

Select  $\rightleftarrows$  (or RELAY) to record on both sides.

## 9 Press REC PAUSE/START.

Recording starts.

To cancel Program Edit in stop mode

Press PLAY MODE/DIRECTION on the remote repeatedly until “1 DISC” or “ALL DISCS” appears in the display.

## Timer-recording radio programs

To timer-record, you must set the clock (see “Setting the clock” on page 16) and preset the radio stations (see “Presetting radio stations” on page 41) beforehand.

### 1 Tune in the preset radio station (see “Listening to the radio” on page 42).

### 2 Press CLOCK/TIMER SET on the remote.

“DAILY SET?” appears.

### 3 Press $\blacktriangleleft$ or $\blacktriangleright$ repeatedly to select “REC SET?”, then press ENTER on the remote.

“ON” appears and the hour indication flashes.

### 4 Set the time to start recording.

Press  $\blacktriangleleft$  or  $\blacktriangleright$  repeatedly to set the hour, then press ENTER on the remote.

The minute indication flashes.

Press  $\blacktriangleleft$  or  $\blacktriangleright$  repeatedly to set the minutes, then press ENTER on the remote.

The hour indication flashes again.

### 5 Set the time to stop recording following step 4.

The start time appears, followed by the stop time, the preset radio station to be recorded (e.g., “TUNER FM 5”), then the original display appears.

### 6 Insert a recordable tape into deck B.

### 7 Turn off the power.

When the recording starts, the volume level is set to the minimum.

To	Do this
Check the setting	Press CLOCK/TIMER SELECT on the remote and press $\blacktriangleleft$ or $\blacktriangleright$ repeatedly to select “REC SELECT?”, then press ENTER on the remote.
Change the setting	Start over from step 1.
Cancel the Timer-recording	Press CLOCK/TIMER SELECT on the remote and press $\blacktriangleleft$ or $\blacktriangleright$ repeatedly to select “TIMER OFF?”, then press ENTER on the remote.

#### Notes

- If the power is on at the preset time, the Timer-recording does not work.
- When you use the Sleep Timer, the Timer-recording will not turn on the system until the Sleep Timer turns it off.
- The power turns on 15 seconds before the preset time.
- You cannot activate the Daily timer and the Timer-recording simultaneously.

### Note

- When you select or play a Super Audio CD;
- The sound effects are automatically turned off (except for the equalization).
  - The sound effect or the personal file cannot be selected. You cannot store the personal file.

## Adjusting the sound

### Press GROOVE on the remote.

Each time you press the button, the display changes cyclically as follows:

GROOVE ON → V-GROOVE ON → GROOVE OFF

**GROOVE:** The volume switches to power mode and the equalizer curve changes to suit the music source.

**V-GROOVE:** The volume switches to power mode and the equalizer curve changes to suit the movie source.

## Selecting the sound effect

Press one of the DSP buttons (**MUSIC MODE**, **MOVIE MODE**, **GAME MODE**, or **TOOL MODE**) on the remote repeatedly to select the sound effect you want.

The sound effect name appears in the display. See “Sound effect options” below.

To cancel

Press EFFECT on the remote repeatedly to select “EFFECT OFF”. All the parameters become flat.

Sound effect options

You can enjoy surround sound simply by selecting one of the sound effect according to the program you want to listen to.

DSP MODE	Options
MUSIC MODE	LIVE HOUSE HALL S.ENHANCE (SOUND ENHANCE) RADIO SOUND
MOVIE MODE	C.STUDIO EX A (CINEMA STUDIO EX A) <b>DCS</b> * C.STUDIO EX B (CINEMA STUDIO EX B) <b>DCS</b> * C.STUDIO EX C (CINEMA STUDIO EX C) <b>DCS</b> * NORMAL SURR (NORMAL SURROUND)
GAME MODE	ARCADE RACING ADVENTURE BATTLE
TOOL MODE	PAN** FLANGER KEY CONTROL EXCITER COMPRESSOR REVERB EARLY RFLC. (EARLY REFLECTION)

\* Sound effects with virtual speakers.

\*\* Virtual effects with “2.1CH”, or “AUTO” with “2.1CH” only .

About DCS (Digital Cinema Sound)

The sound effects with **DCS** marks use DCS technology.

In the collaboration with Sony Pictures Entertainment, Sony measured the sound environment of their studios and integrated the data of the measurement and Sony’s own DSP (Digital Signal Processor) technology to develop “Digital Cinema Sound”. “Digital Cinema Sound” simulates in a home theater an ideal movie theater sound environment based on the preference of movie director.



## Enjoying movies with Cinema Studio EX

Cinema Studio EX is ideal for enjoying the movie software encoded with multi channel format, such as the Dolby Digital DVD. This mode reproduces the sound characteristics of Sony Pictures Entertainment's studios.

### ■ C.STUDIO EX A (Cinema Studio EX A)

Reproduces the sound characteristics of the Sony Pictures Entertainment "Cary Grant Theater" cinema production studio. This is a standard mode, great for watching most any type of movie.

### ■ C.STUDIO EX B (Cinema Studio EX B)

Reproduces the sound characteristics of the Sony Pictures Entertainment "Kim Novak Theater" cinema production studio. This mode is ideal for watching science-fiction or action movies with lots of sound effects.

### ■ C.STUDIO EX C (Cinema Studio EX C)

Reproduces the sound characteristics of the Sony Pictures Entertainment scoring stage. This mode is ideal for watching musicals or classic films where music is featured in the soundtrack.

## About Cinema Studio EX

Cinema Studio EX consists of the following three elements.

- Virtual Multi Dimension  
Creates 5 sets of virtual speakers surrounding the listener from a single pair of actual rear speakers.
- Screen Depth Matching  
In a movie theater, sound seems to come from inside the image reflected on the movie screen. This element creates the same sensation in your listening room by shifting the sound of the front speakers "into" the screen.
- Cinema Studio Reverberation  
Reproduces the reverberations peculiar to a movie theater.

Cinema Studio EX is the integrated mode which operates these elements simultaneously.

## Note

The effects provided by the virtual speakers may cause increased noise in the playback signal.

## Enjoying Dolby Pro Logic II (DHC-FL7D only)

This system can reproduce 2 channel sound in 5.1 channels through Dolby Pro Logic II.

- 1 Set 2.1CH/MULTI to "MULTI", then select "EFFECT OFF" or "NORMAL SURROUND".
- 2 Press AMP MENU.
- 3 Press  $\uparrow$  or  $\downarrow$  repeatedly to select "DOLBY PL MENU".
- 4 Press ENTER.
- 5 Press  $\leftarrow$  or  $\rightarrow$  repeatedly to select the PL II mode.
- 6 Press ENTER.

The selected mode appears in the display.

## 2 channel decoding modes

Pro Logic II only works with 2CH and 2.1CH (digital) sources. All other sources receive Pro Logic decoding.

- PRO LOGIC  
Performs Pro Logic decoding. The source recorded in 2 channel is decoded into 4.1 channels.
- PL II MOVIE  
Performs Pro Logic II movie mode decoding. This setting is ideal for movies encoded in Dolby Surround. In Addition, this mode can reproduce sound in 5.1 channel when watching videos of overdubbed or old movies.
- PL II MUSIC  
Performs the Pro Logic II music mode decoding. This setting is ideal for normal stereo sources such as CDs.

## Adjusting the sound effects

Before operation, first select the sound effect you want for your basic sound.

### 1 Press DSP EDIT on the remote.

Each time you press the button, the display changes cyclically as follows:

DSP EDIT\* (to adjust DSP) → EQ EDIT (to adjust equalizer)

\* This menu does not appear depending on the audio effect.

### 2 Use the digipad to adjust the parameters.

The parameter is adjusted according to the curve your finger slides on the digipad.

Adjustable parameters are described on this page. After the curve your finger slides is displayed for a while, then the curve automatically adjusted by the unit is displayed. For DSP EDIT, the adjustable parameters vary depending on the preset effect.

### 3 Press ENTER on the remote.

To cancel

Press EFFECT on the remote repeatedly to select "EFFECT OFF". The adjustment for the selected parameter is canceled.

## Adjustable parameters

Menu	Right/Left (X)	Up/Down (Y)
DSP EDIT	(See the chart below)	
EQ EDIT	Frequency	Level

## Adjustable DSP parameters

Sound effect options	Right/Left (X)	Up/Down (Y)
LIVE HOUSE	Time	Wall type
HALL	Time	Wall type
S.ENHANCE	Time	Level
RADIO SOUND	Time	Level
C.ST.EX A	Level	—
C.ST.EX B	Level	—
C.ST.EX C	Level	—
NORMAL SURR	—	—
ARCADE	Time	Level
RACING	Shape	—
ADVENTURE	Frequency	Level
BATTLE	Time	Wall type
PAN	Position	Position
FLANGER	Frequency	Level
KEY CONTROL	Key	Time
EXCITER	Frequency	Level
COMPRESSOR	Time	Level
REVERB	Time	Wall type
EARLY RFLC.	Shape	—

Wall type: This parameter lets you control the level of the high frequencies to alter the sonic character of your listening environment by simulating a softer or harder wall.

Position: This parameter lets you control the position where the sound comes from.

### Tips

- You can use the cursor buttons (▲/▼/◆/▶) on the remote instead of the digipad.
- You can store the adjusted effect in a personal file (see "Creating a personal sound effect file" on page 51).

# Creating a personal sound effect file

## — *Personal file*

You can store the adjusted sound effects in the system's memory. You can create up to 5 sound effect files.

- 1 Obtain the sound effect you want to store to P FILE.**
- 2 Press and hold P FILE on the remote.**  
The personal file number appears in the display.
- 3 Slide your finger on the digipad to select the file number where you want to store the effect.**
- 4 Press ENTER on the remote.**

To call up a personal file

Press P FILE on the remote repeatedly to select the file.

### Tip

You can use the cursor buttons (▲/▼/◀/▶) on the remote instead of the digipad.

### Note

When using personal files, the adjustable DSP EDIT parameters depend on the original sound effect.

## Turning off the display

### — Power Saving Mode

The demonstration display (display window and buttons lighting and flashing even when the system power is off) and the clock display can be turned off to minimize the amount of power consumed during standby (Power Saving Mode).

**Press DISPLAY repeatedly while the system is off until the demonstration display or the clock display disappears.**

To cancel Power Saving Mode  
Press DISPLAY while the system is off. Each time you press the button, the display switches cyclically as follows:

Demonstration display → Clock display\* → No display (Power Saving Mode)

\* The clock is displayed only if you set the clock.

#### Tip

The timer continues to operate in Power Saving Mode.

#### Note

During the Power Saving Mode, the following functions do not work:

- Setting the time.
- Changing the AM tuning interval.
- Pressing a function button to turn the power on.
- Switching the function of VIDEO (MD) (North American model) or MD (VIDEO) (other models).

## Using the display

Checking the remaining time/titles (DVD/VIDEO CD/CD/Super Audio CD/MP3 file)

When a DVD/CD/Super Audio CD TEXT disc is loaded, you can check the information stored on the disc, such as the titles. When the unit detects DVD/CD/Super Audio CD TEXT discs, the “TEXT” indication appears in the display.

### Press DISPLAY during playback.

Each time you press the button, the display changes cyclically as follows:

#### ■ When playing a DVD

Current title number and the playing time →  
Current title number and the remaining time →  
Current chapter number and the playing time →  
Current chapter number and the remaining time →  
Title text → Clock display (for 8 seconds) → Effect status

#### ■ When playing a VIDEO CD/CD/Super Audio CD

Current track number and the playing time\*<sup>1</sup> →  
Current track number and the remaining time\*<sup>1</sup> →  
Playing time of the current disc\*<sup>2</sup> →  
Remaining time on the current disc\*<sup>2</sup> →  
Track title → Clock display (for 8 seconds) → Effect Status

#### ■ When playing an MP3

Current track number and the playing time →  
Current track number and the remaining time →  
Track title (and ID3 tag when the file contains the ID3 tag data) →  
Album title →  
Clock display → Effect status (for 8 seconds)

\*<sup>1</sup> When playing VIDEO CDs with PBC functions, only the playing time of the scene is displayed.

\*<sup>2</sup> These are not displayed during Shuffle Play or Program Play.

This information is skipped when playing a VIDEO CD with PBC functions.

Checking the total playing time/titles (DVD/VIDEO CD/CD/Super Audio CD)

### Press DISPLAY in stop mode.

Each time you press the button, the display changes cyclically as follows:

Total number of tracks and the total playing time\*<sup>3</sup> →  
Disc title → Clock display (for 8 seconds) → Effect Status

\*<sup>3</sup> The number of titles is displayed when playing a DVD.

## To adjust the brightness of the display

Use the remote for the operation.

- 1 Press AMP MENU.
- 2 Press ENTER.
- 3 Press  $\uparrow$  or  $\downarrow$  repeatedly to select "DIMMER".
- 4 Press  $\leftarrow$  or  $\rightarrow$  repeatedly to select the setting you want.  
DIMMER 1  $\leftrightarrow$  DIMMER 2  $\leftrightarrow$  DIMMER 3
- 5 Press ENTER.

## To listen to multi channel sound

**Press 2.1CH/MULTI on the remote.**

Each time you press the button, the display changes as follows:

2.1CH  $\rightarrow$  MULTI  $\rightarrow$  AUTO

**2.1CH:** The sound is output in 2-channel stereo and the sub woofer.

**MULTI:** The sound is output in multi channel.

**AUTO:** Automatically switches between 2.1CH and MULTI according to the type of disc being played.

2.1CH: for CD, dts-CD, SACD, MP3

MULTI: for DVD, VCD

Notes

- When using headphones, this setting is fixed to "2.1CH".
- When you select "AUTO" in DIGITAL function, the sound is output in 2.1 channel.

To adjust the decoding format mode

This operation lets you specify the decode type for the signal input to the digital audio jacks and DVD function.

- 1 Press AMP MENU.
- 2 Press  $\uparrow$  or  $\downarrow$  repeatedly to select "DECODE FORMAT".
- 3 Press ENTER.
- 4 Press  $\leftarrow$  or  $\rightarrow$  repeatedly to select the decode format mode.
- 5 Press ENTER.
  - "AUTO MODE" switches between DTS, Dolby Digital, or PCM decoding automatically.
  - "PCM MODE" decodes all the input signals as PCM signals. If Dolby Digital, DTS, or MPEG (etc.) signals are input, no sound will be heard. Set to "PCM MODE" if, when set to "AUTO MODE", sound from the digital audio jacks (for CD etc.) is interrupted when playback starts.

## Singing along: Karaoke

(Except for North American and European models)

You can sing along with any stereo CD or tape by turning down the singer's voice. You need to connect an optional microphone.

- 1 Turn **MIC LEVEL** to **MIN** to turn down the microphone volume.
- 2 Connect an optional microphone to **MIC jack**.

- 3 Press **KARAOKE PON** on the remote.

Each time you press the button, the display changes cyclically as follows:

KARAOKE PON → MPX R →  
MPX L → Effect status\*

\* KARAOKE PON is cancelled.

To sing karaoke by decreasing the vocal level of a CD or a tape, select "KARAOKE PON". To sing karaoke of multiplex CD, select "MPX R" or "MPX L".

- 4 Start playing the music and adjust the volume.
- 5 Adjust the microphone volume by turning **MIC LEVEL**.

To adjust the echo level (Asian model only)

Turn **ECHO LEVEL** to adjust the echo level.

After you have finished

Turn **MIC LEVEL** to **MIN** and disconnect the microphone from **MIC jack**, then press **KARAOKE PON** repeatedly until "🔇" disappears.

### Notes

- With some songs, vocals may not be canceled when you select "KARAOKE PON".
- If you recall a sound effect, the karaoke mode is canceled.
- During "KARAOKE PON", "MPX R" or "MPX L", **EFFECT** button does not work.
- During "KARAOKE PON", "MPX R" or "MPX L", **DSP** effect switches to "KEY CONTROL". When the karaoke effect is canceled, the **DSP** effect before entering the karaoke effect is applied again.
- The instrumental sound may be reduced as well as the singer's voice when the sound is recorded in monaural.
- The singer's voice may not be reduced when:
  - only a few instruments are playing.
  - a duet is being played.
  - the source has strong echoes or chorus.
  - the singer's voice deviates from the center.
  - the voice on the source is singing in high soprano or tenor.
- When you select or play a Super Audio CD, the karaoke mode is automatically canceled. You cannot select the karaoke mode while selecting or playing a Super Audio CD.

### Mixing and recording sound

- 1 Do the procedure for "Singing along" (steps 1 through 5). Then, load a recordable tape in deck B.
- 2 Press the function button of the source you want to record (e.g. DVD).  
When you want to record from TAPE A, press **TAPE A/B** repeatedly until **TAPE A** is selected.
- 3 Press **REC PAUSE/START**.  
Deck B stands by for recording.
- 4 Press **PLAY MODE/DIRECTION** on the remote repeatedly to select  $\rightleftarrows$  to record on one side. Select  $\leftrightarrow$  (or **RELAY**) to record on both sides.
- 5 Press **REC PAUSE/START**.  
Recording starts.
- 6 Press  $\triangleleft \triangleright$  to start playing the source to be recorded.  
Start singing along the music.

To stop recording

Press  $\blacksquare$ .

## Tips

- If acoustic feedback (howling) occurs, move the microphone away from the speakers or change the direction of the microphone.
- If you want to record your voice through the microphone only, you can do so by selecting the DVD function and not playing a disc.
- When high level sound signals are input, the unit automatically adjusts the recording level to prevent distortion of the recorded sound signal (Auto Level Control Function).

## About indicators

### **MULTI CHANNEL DECODING indicator:**

Lights up except when the 2 channel source is being played back in DVD or DIGITAL function.

### **PRO LOGIC indicator** (in the display):

Lights up when the unit applies Dolby Pro Logic processing to 2 channel signals in order to output the center and rear channel signals.

### **DIGITAL indicator** (in the display):

Lights up when the unit is decoding signals recorded in the Dolby Digital format.

**dts indicator** (in the display): Light up when DTS signals are input.

## Falling asleep to music

### — *Sleep Timer*

You can set the system to turn off at a preset time, so you can fall asleep to music.

### **Press SLEEP on the remote.**

Each time you press the button, the minute display (the turn-off time) changes as follows:

AUTO\* → 90 → 80 → 70 → ... →  
10 → OFF

\* The power turns off when the current disc or tape finishes playback (for up to 100 minutes).

To	Press
Check the remaining time**	SLEEP on the remote once.
Change the time to turn off	SLEEP on the remote repeatedly to select the time you want.
Cancel the Sleep Timer	SLEEP on the remote repeatedly until "SLEEP OFF" appears.

\*\* You cannot check the remaining time if you select "AUTO".

# Waking up to music

## — Daily Timer

You can wake up to music at a preset time every day. Make sure you have set the clock (see “Setting the clock” on page 16).

### 1 Prepare the music source you want to play.

- DVD/VIDEO CD/CD/Super Audio CD/MP3: Load a disc. To start from a specific track, make a program (see “Creating your own program” on page 22).
- Tape: Load a tape with the side you want to play facing forward.
- Radio: Tune in the preset station you want (see “Listening to the radio” on page 42).

### 2 Adjust the volume.

### 3 Press CLOCK/TIMER SET on the remote.

“SET” appears.

### 4 Press ◀◀ or ▶▶ repeatedly to select “DAILY SET?”, then press ENTER on the remote.

“ON” appears and the hour indication flashes.

### 5 Set the time to start playback.

Press ◀◀ or ▶▶ repeatedly to set the hour, then press ENTER on the remote. The minute indication flashes.

Press ◀◀ or ▶▶ repeatedly to set the minutes, then press ENTER on the remote. The hour indication flashes again.

### 6 Set the time to stop playback following step 5.

### 7 Press ◀◀ or ▶▶ repeatedly until the music source you want appears.

The indications change as follows:



### 8 Press ENTER on the remote.

The type of timer (“DAILY TIMER”), followed by the start time, stop time and the music source, appears, then the original display appears.

### 9 Turn off the power.

To	Do this
Check the setting	Press CLOCK/TIMER SELECT on the remote and press ◀◀ or ▶▶ repeatedly to select “DAILY SELECT?”, then press ENTER on the remote.
Change the setting	Start over from step 1.
Cancel the Daily Timer	Press CLOCK/TIMER SELECT on the remote and press ◀◀ or ▶▶ repeatedly to select “TIMER OFF?”, then press ENTER on the remote.

#### Notes

- If the power is on at the preset time, the Daily Timer does not work.
- When you use the Sleep Timer, the Daily Timer will not turn on the system until the Sleep Timer turns it off.
- The power turns on 15 seconds before the preset time.
- You cannot activate the Daily timer and the Timer-recording simultaneously.



## Hooking up optional components

To enhance your system, you can connect optional components. Refer to the operating instructions provided with each component.

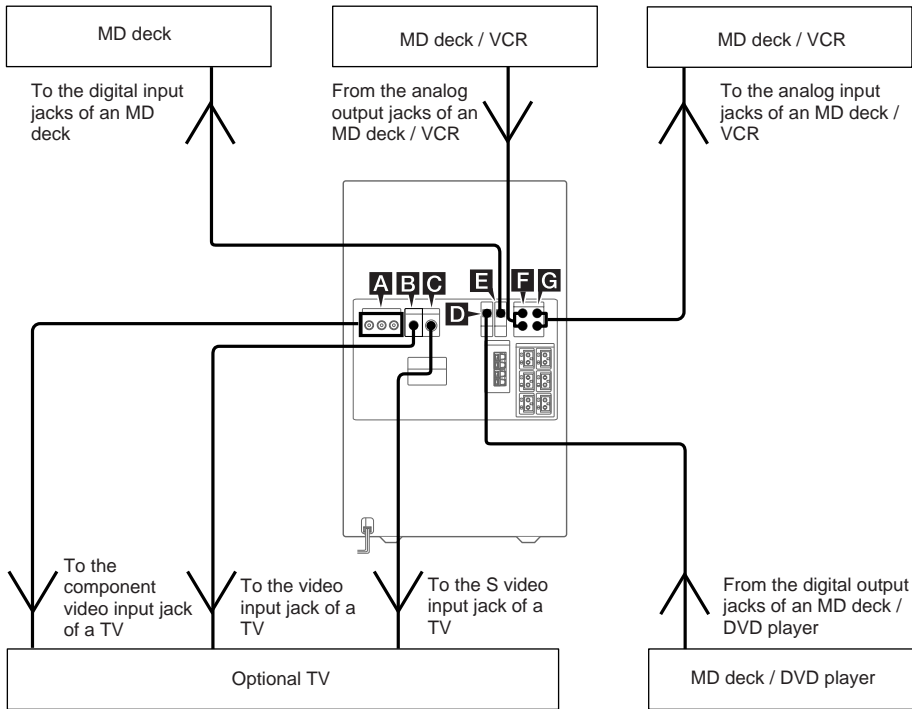

### **A** COMPONENT VIDEO OUT jacks

Use video cables (not supplied) to connect an optional component (such as a TV) to this jack. If your TV accept progressive format file signals, you must use this connection and set “COMPONENT OUT” to “PROGRESSIVE” in “SCREEN SETUP” (page 28).

### **B** VIDEO OUT jack

Use a video cable (supplied) to connect an optional component (such as a TV) to this jack. You can then output the video to the component from this unit, and enjoy the video images of DVDs, etc.

### **C** S VIDEO OUT jack

Use an S video cable (not supplied) to connect an optional component (such as a TV) to this jack. You can then output the video to the component from this unit, and enjoy higher quality video images.

### **D** OPTICAL DIGITAL IN jack

Use a digital optical cable (square, not supplied) to connect an MD deck or DVD player to this jack. You can then record or listen to digital audio from the MD deck or DVD player through this system.

continued

## Hooking up optional components (continued)

### **E** OPTICAL DVD DIGITAL OUT jack

Use a digital optical cable (square, not supplied) to connect an MD deck to this jack. You can then output the digital audio to the MD deck from this system.

### **F** VIDEO (MD) IN jacks (North American model only)

MD (VIDEO) IN jacks  
(other models)

Use audio cords (not supplied) to connect an MD deck or VCR to these jacks. You can then listen to analog audio from the MD deck or VCR through this system.

### **G** VIDEO (MD) OUT jack (North American model only)

MD (VIDEO) OUT jacks  
(other models)

Use audio cords (not supplied) to connect an MD deck or VCR to these jacks. You can then output audio to the MD deck or VCR from this system.

#### Tip

When you remove the optical cover, keep it for future use.

## Listening to audio from a connected component

Listening to the digital audio from the connected MD deck or DVD player

### 1 **Connect the digital optical cable.**

See “Hooking up optional components” on page 57.

### 2 **Press DIGITAL (or FUNCTION on the remote repeatedly until “DIGITAL” appears).**

Start playing the connected component.

Listening to the analog audio from the connected MD deck or VCR

### 1 **Connect the audio cords.**

See “Hooking up optional components” on page 57.

### 2 **(For North American model)**

To listen to the sound of the connected VCR:

**Press VIDEO (MD) (or FUNCTION on the remote repeatedly until “VIDEO (MD)” appears).**

Start playing the connected component.

To listen to the sound of the connected MD deck:

Hold down VIDEO (MD) and press **I/⏏** while the power is on. Release **I/⏏** first, then release VIDEO (MD). This switches the function from VIDEO to MD. Once you switched to the MD function, just press VIDEO (MD).

Start playing the connected component.

**(Other models)**

To listen to the sound of the connected MD deck:

**Press MD (VIDEO) (or FUNCTION on the remote repeatedly until “MD (VIDEO)” appears).**

Start playing the connected component.

To listen to the sound of the connected VCR:

Hold down MD (VIDEO) and press I/⏻ first, then release MD (VIDEO). This switches the function from MD to VIDEO. Once you switched to the VIDEO function, just press MD (VIDEO).

Start playing the connected component.

**Note**

If the sound is distorted or too loud when VIDEO function is selected, or you want to switch back to MD function, repeat the operation described above to switch to MD function.

## Recording audio from a connected component

- 1 Connect the audio cords.**  
See “Hooking up optional components” on page 57.
- 2 Start recording manually.**  
See “Recording to a tape” on page 45.

## Recording on a connected component

- 1 Connect the audio cords for analog recording, or connect the digital optical cable for digital recording.**
- 2 Press EFFECT repeatedly to select “EFFECT OFF”.**
- 3 Press 2.1CH/MULTI on the remote repeatedly to select “2.1CH”.**
- 4 Start recording.**  
Refer to the operating instructions provided with connected component.

**Notes**

- Digital signals are output from OPTICAL DVD DIGITAL OUT jack during DVD function only. Besides, the sound output from the OPTICAL DVD DIGITAL OUT jack is not affected by the sound adjustment. Digital signals from Super Audio CDs are not output from OPTICAL DVD DIGITAL OUT (DHC-FL7D only).
- This unit is not compatible with 96 kHz sampling frequencies and Super Audio CD format.
- While recording, do not change the 2.1CH/MULTI setting.

## Problems and remedies

If you run into any problem using this unit, use the following check list.

First, check that the power cord is connected firmly and the speakers are connected correctly and firmly.

Should any problem persist, consult your nearest Sony dealer.

### General

---

#### Even when the power is turned off, the display and buttons light up and flash.

- While the power is turned off, press DISPLAY repeatedly to enter clock mode or power saving mode.

---

#### “--.--” lights up in the display.

- A power interruption occurred. Set the clock and timer settings again.

---

#### The display starts flashing as soon as you plug in the power cord even though you haven't turned on the power.

- The demonstration mode started. Press I/⏻ (see step 5 on page 12).

---

#### The clock setting/timer is canceled.

- The power cord is disconnected or a power failure occurs. Redo “Setting the clock” (page 16). If you have set the timer, redo “Waking up to music” (page 56) and/or “Timer-recording radio programs” (page 47).

---

#### The radio presetting is canceled.

- The power cord is disconnected or a power failure occurs for longer than half a day. Redo “Presetting radio stations” (page 41).

---

#### There is no sound.

- Turn VOLUME clockwise.
- The headphones are connected.
- Insert only the stripped portion of the speaker cord into the SPEAKER jack. Inserting the vinyl portion of the speaker cord will obstruct the speaker connections.
- The protective device on the amplifier has been activated because of a short circuit. (“PROTECT” and “PUSH POWER” flash alternately.) Turn off the power, eliminate the short-circuit problem and turn on the power again.
- There is no audio output during Timer-recording.

---

#### There is severe hum or noise.

- A TV or VCR is placed too close to the unit. Move the unit away from the TV or VCR.

---

#### The sound from the component connected to the VIDEO (MD) jacks (North American model only) or MD (VIDEO) jacks (other models) is distorted.

- Check the function setting of VIDEO (MD) (North American model) or MD (VIDEO) (other models) (see “Note: Listening to audio from a connected component” on page 59).

---

#### The timer does not function.

- Set the clock correctly.

---

#### “DAILY” or “REC” does not appear when you press CLOCK/TIMER SELECT on the remote.

- Set the timer correctly.
- Set the clock.

---

#### The remote does not function.

- There is an obstacle between the remote and the unit.
- The remote is not pointing in the direction of the unit's sensor.
- The batteries have run down. Replace the batteries.

---

#### There is acoustic feedback.

- Decrease the volume level.
- Move the microphone away from the speakers or change the direction of the microphone.

---

#### The color irregularity on a TV screen persists.

- Turn off the TV set, then turn it on after 15 to 30 minutes. If the color irregularity still persists, place the speakers farther away from the TV set.

---

**“PROTECT” and “PUSH POWER” appear alternately.**

- A strong signal is input. Turn off the power, leave the system turned off for a while, then turn on the power again. If “PROTECT” and “PUSH POWER” still appear alternately, check the speaker cords.

---

**“DVD CLOSE!” appears.**

- You tried to open the cassette deck when the disc tray is open. Press ▲ to close the disc tray first, then open the cassette deck.

---

**“TAPE CLOSE!” appears.**

- You tried to open the disc tray when the cassette deck is open. Push the cassette deck to close first, then open the disc tray.
- 

## Speakers

---

**Sound comes from only one channel or unbalanced left and right volume.**

- Check the speaker connection and speaker placement.
- The source being played back is monaural.
- Adjust the balance parameters (page 15).

---

**There is no sound from the center speaker.**

- Set the center speaker level to the appropriate level.
- 2.1CH/MULTI is set to “2.1CH”.

---

**There is no sound from the rear speakers.**

- Set the rear speakers level to the appropriate level.
- 2.1CH/MULTI is set to “2.1CH”.
- The software being played back has limited sound effects. Check the volume with the test tone.

---

**Sound lacks bass.**

- Check that the speaker’s + and – terminals are connected correctly.
- 

## DVD/VIDEO CD/CD/Super Audio CD/MP3 Player

---

**The disc tray does not open and “LOCKED” appears on the front panel display.**

- Contact your Sony dealer or local authorized Sony service facility.

---

**The disc tray does not close.**

- Place the disc correctly in the center of the tray.
- Always close the tray by pressing ▲. Trying to press the tray closed with your fingers may cause problems with the player.

---

**The disc does not eject.**

- You cannot eject the disc during CD Synchro Recording. Press ■ to cancel the CD Synchro Recording, then press ▲ to eject the disc.
- Consult your nearest Sony dealer.

---

**Play does not start.**

- Open the disc tray and check whether a disc is loaded.
- Wipe the disc clean (see page 65).
- Replace the disc.
- Place the disc correctly in the center of the tray.
- Place the disc in the tray with the label side up.
- Remove the disc and wipe away the moisture on the disc, then leave the system turned on for a few hours until the moisture evaporates.
- Press ◀▶ to start play.
- The region code on the DVD does not match the system.
- Cancel the Custom Parental Control function.

---

**The sound skips.**

- Wipe the disc clean (see page 65).
- Replace the disc.
- Try moving the system to a place without vibration (e.g., on top of a stable stand).
- Try moving the speakers away from the system, or placing them on separate stands. When you listen to a track with bass sounds at high volume, the speaker vibration may cause the sound to skip.

continued

## **Problems and remedies (continued)**

---

### **Play does not start from the first track.**

- The player is in Program Play or Shuffle Play mode. Press PLAY MODE/DIRECTION on the remote repeatedly until “1 DISC” or “ALL DISCS” appears.
  - Resume Play has been selected. When the playback is stopped, press ■, then start DVD playback (page 17).
  - The title, DVD, or PBC menu automatically appears on the TV screen. Follow the instructions on the TV screen.
- 

### **The MP3 audio track cannot be played.**

- The DATA CD is not recorded in the MP3 format that conforms to ISO9660 Level 1/ Level 2 or Joliet.
  - The MP3 audio track does not have the extension “.MP3.”
  - The data is not formatted in MP3 even though it has the extension “.MP3”.
  - The data is not MPEG1 Audio Layer 3 data.
  - The player cannot play audio tracks in MP3PRO format.
- 

### **The title of the MP3 audio album or track is not correctly displayed.**

- The player can only display numbers and alphabet. Other characters are displayed as spaces.
- 

## **Picture**

---

### **Playback starts automatically.**

- The DVD features an auto playback function. Refer to the operating instructions supplied with the disc.
- 

### **Playback stops automatically.**

- Some discs may contain an auto pause signal. While playing such a disc, the playback stops at the auto pause signal. Refer to the operating instructions supplied with the disc.
- 

### **You cannot perform some functions such as Stop, Scan, Slow-motion Play, Repeat Play, Shuffle Play, or Program Play.**

- Depending on the disc, you may not be able to do some of the operations described above. Refer to the operating instructions supplied with the disc.
- 

### **Messages do not appear on the screen in the language you want.**

- Select the language you want for the on-screen display in “OSD” under “LANGUAGE SETUP” in the Setup Display (page 27).
- 

### **The language for the sound track cannot be changed.**

- Multilingual tracks are not recorded on the DVD being played.
  - The DVD prohibits changing the language for the sound track. Refer to the operating instructions supplied with the disc.
- 

### **The subtitle language cannot be changed.**

- Multilingual subtitles are not recorded on the DVD being played.
  - The DVD prohibits changing the subtitles. Refer to the operating instructions supplied with the disc.
- 

### **The subtitle cannot be turned off.**

- The DVD prohibits turning off subtitles. Refer to the operating instructions supplied with the disc.
- 

### **The angles cannot be changed.**

- Multi-angles are not recorded on the DVD being played. The angle can be changed only when the “ANGLE” indicator lights up on the front panel display (page 36).
  - The DVD prohibits changing the angles. Refer to the operating instructions supplied with the disc.
-

---

**There is no picture.**

- Press DVD (or FUNCTION on the remote repeatedly until “DVD” appears).
  - Check that the system is connected securely.
  - The video cable is damaged. Replace it with a new one.
  - Make sure you connect the system to the video input jack of your TV (page 11).
  - Make sure you turn on the TV.
  - Make sure you select the video input on the TV so that you can view the pictures from the system.
- 

**The picture noise appears.**

- Clean the disc.
  - If video from this system has to go through your VCR to get to your TV, the copy-protection applied to some DVD programs could affect picture quality. If you still experience problems after checking your connections, please try connecting this system directly to your TV’s S video-input, if your TV is equipped with this input (page 57).
  - Except for Pan American and European model, the color system is different. Set the color system to match your TV (pages 29).
- 

**The aspect ratio of the screen cannot be changed even though you set “TV TYPE” in “SCREEN SETUP” in the Setup Display when you play a wide picture.**

- The aspect ratio is fixed on your DVD.
  - If you connect the system with the S-video cable, connect directly to the TV. Otherwise, you may not change the aspect ratio.
  - Depending on the TV, you may not change the aspect ratio.
- 

**A 5-character service number is displayed on the screen and on the front panel display.**

- The self-diagnosis function is activated. (See the table on page 64).
- 

## Tape Deck

---

**The tape does not record.**

- The tab has been removed from the cassette (see “To save a tape permanently” on page 65).
  - The tape has reeled to the end.
- 

**The tape does not record nor play, or there is a decrease in sound level.**

- The heads are dirty (see “Cleaning the tape heads” on page 66).
  - The record/playback heads are magnetized (see “Demagnetizing the tape heads” on page 66).
- 

**The tape does not erase completely.**

- The record/playback heads are magnetized (see “Demagnetizing the tape heads” on page 66).
- 

**There is excessive wow or flutter, or the sound drops out.**

- The capstans or pinch rollers are dirty (see “Cleaning the tape heads” on page 66).
- 

**Noise increases, or the high frequencies are erased.**

- The record/playback heads are magnetized (see “Demagnetizing the tape heads” on page 66).
- 

**After pressing ◀▶ or ▲, there is a mechanical noise, “EJECT” appears in the display, and the unit enters standby mode automatically.**

- The cassette tape is not inserted correctly.
- 

**continued**

## Problems and remedies (continued)

### Tuner

There is severe hum or noise (“TUNED” or “STEREO” flashes in the display).

- Adjust the antenna.
- The signal is too weak. Connect an external antenna.

A stereo FM program cannot be received in stereo.

- Press REPEAT/FM MODE on the remote so that “MONO” disappears.

If other troubles not described above occur, reset the system as follows:

- 1 Press **■**, DISPLAY and DVD TOP MENU at the same time.
- 2 Unplug the power cord.
- 3 Plug the power cord back in.
- 4 Press I/⏻ to turn on the power.

The system is reset to the factory settings except for DVD settings. You should set the settings you made, such as the preset stations, clock, and timer.

To reset the DVD settings, select “RESET” in step 2 of “Using the Setup Display” (page 26). After you select “RESET” and press ENTER, select “YES”, then press ENTER to reset the settings (it takes a few seconds to complete). Do not press I/⏻ when resetting the system.

## Self-diagnosis function

**(When letters/numbers appear in the display)**

When the self-diagnosis function is activated to prevent the system from malfunctioning, a five-character service number (e.g., C 13 00) with a combination of a letter and digits appears on the screen. In this case, check the following table.

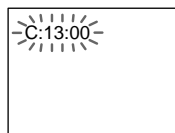

First three characters of the service number	Cause and/or Corrective Action
C 13	The disc is dirty ➔ Clean the disc with a soft cloth (see page 65).
C 31	The disc is not inserted correctly. ➔ Re-insert the disc correctly.
E XX (XX is a number)	To prevent a malfunction, the system has performed the self-diagnosis function. ➔ Contact your nearest Sony dealer or local authorized Sony service facility and give the 5-character service number. Example: E 61 10



## Precautions

### On operating voltage

Before operating the unit, check that the operating voltage of your unit is identical with the voltage of your local power supply.

### On safety

- The unit is not disconnected from the AC power source (mains) as long as it is connected to the wall outlet, even if the unit itself has been turned off.
- Unplug the unit from the wall outlet (mains) if it is not to be used for an extended period of time. To disconnect the cord (mains lead), pull it out by the plug. Never pull the cord itself.
- Should any solid object or liquid fall into the component, unplug the unit and have the component checked by qualified personnel before operating it any further.
- The AC power cord must be changed only at a qualified service shop.

### On placement

- Do not place the unit in an inclined position.
- Do not place the unit in locations where it is:
  - extremely hot or cold
  - dusty or dirty
  - very humid
  - vibrating
  - subject to direct sunlight.
- Use caution when placing the unit or speakers on surfaces that have been specially treated (with wax, oil, polish, etc.) as staining or discoloration of the surface may result.

### On heat buildup

- Although the unit heats up during operation, this is not a malfunction.
- Place the unit in a location with adequate ventilation to prevent heat build-up in the unit.

If you continuously use this unit at a large volume, the cabinet temperature of the top, side and bottom rises considerably. To avoid burning yourself, do not touch the cabinet.

To prevent a malfunction, do not cover the ventilation hole for the cooling fan.

### On operation

- If the unit is brought directly from a cold to a warm location, or is placed in a very damp room, moisture may condense on the lens inside the CD player. Should this occur, the unit will not operate properly. Remove the CD and leave the unit turned on for about an hour until the moisture evaporates.
- When you move the unit, take out any discs.

If you have any questions or problems concerning the unit, please consult your nearest Sony dealer.

### Notes on discs

- Before playing, clean the disc with a cleaning cloth. Wipe the disc from the center out.
- Do not use solvents such as benzene, thinner, commercially available cleaners or anti-static spray intended for vinyl LPs.
- Do not expose the disc to direct sunlight or heat sources such as hot air ducts, nor leave it in a car parked in direct sunlight.
- Do not use discs encircled with a protection ring. This may cause a malfunction to the system.
- When using discs that have glue or similar tacky substance on the label side of the disc or that used a special ink when the label was printed, there is a chance that the disc or label may become attached to parts inside this unit. When this occurs, it may not be possible to remove the disc, and may also cause this unit to malfunction. Be sure to check that the label side of the disc is not sticky before using. The following types of disc should not be used:
  - Rental or used discs with attached seals where the glue extends beyond the seal. The perimeter of the seal on the disc is tacky.
  - Discs that have labels printed using a special ink that feels tacky when touched.
- Discs with non-standard shapes (e.g., heart, square, star) cannot be played on this unit. Attempting to do so may damage the unit. Do not use such discs.

### Note on CD-R/CD-RW playback

Discs recorded on CD-R/CD-RW drives may not be played back because of scratches, dirt, recording condition or the drive's characteristics. Besides, the discs, which are not yet finalized at the end of recording, cannot be played back.

### Cleaning the cabinet

Use a soft cloth slightly moistened with mild detergent solution.

### To save a tape permanently

To prevent a tape from being accidentally recorded over, break off the cassette tab from side A or B as illustrated.

If you later want to reuse the tape for recording, cover the broken tab with adhesive tape.

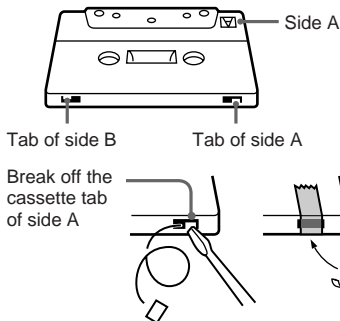

**continued**

## **Precautions (continued)**

Before placing a cassette in the tape deck

Take up any slack in the tape. Otherwise the tape may get entangled in the parts of the tape deck and become damaged.

When using a tape longer than 90 minutes

The tape is very elastic. Do not change the tape operations such as play, stop, and fast-winding etc. frequently. The tape may get entangled in the tape deck.

Cleaning the tape heads

Clean the tape heads after every 10 hours of use. Make sure to clean the tape heads before you start an important recording or after playing an old tape. Use a separately sold dry-type or wet-type cleaning cassette. For details, refer to the instructions of the cleaning cassette.

Demagnetizing the tape heads

Demagnetize the tape heads and the metal parts that have contact with the tape every 20 to 30 hours of use with a separately sold demagnetizing cassette. For details, refer to the instructions of the demagnetizing cassette.

In case color irregularity is observed on nearby a TV screen

With the magnetically shielded type of speaker system, the speakers can be installed near a TV set. However, color irregularity may still be observed on the TV screen depending on the type of your TV set.

If color irregularity is observed...

Turn off the TV set, then turn it on after 15 to 30 minutes.

If color irregularity is observed again...

Place the speakers farther away from the TV set.

## Messages

One of the following messages may appear or flash in the display during operation.

DVD

---

### **No Disc**

There is no disc in the player.

---

### **Push STOP!**

You pressed PLAY MODE/TUNING MODE during play.

---

### **Cannot Use**

You pressed an invalid button.

---

### **Step Full!**

You tried to program 26 or more tracks (steps).

---

TAPE

---

### **No Tab**

You cannot record the tape because the tab has been removed from the cassette.

---

### **No Tape**

There is no tape in the tape deck.

---

TUNER

---

### **WAIT**

The function is switching to the tuner.

---

# Specifications

## AUDIO POWER SPECIFICATION:

### (DHC-FL7D USA model only)

#### POWER OUTPUT AND TOTAL HARMONIC DISTORTION

with 8 ohm loads both channels driven, from 120 Hz – 10 kHz; rates 60 watts per channel minimum RMS power, with no more than 10% total harmonic distortion from 250 milliwatts to rated output.

Continuous RMS power output	
Center speaker:	60 watts (16 ohms at 1 kHz, 10% THD)
Rear speaker:	60 + 60 watts (8 ohms at 1 kHz, 10% THD)
Sub woofer:	120 watts (8 ohms at 100 Hz, 10% THD)

#### Amplifier section

### Canadian model: DHC-FL7D

Continuous RMS power output (reference)	
Front speaker:	60 + 60 watts (8 ohms at 1 kHz, 10% THD)
Center speaker:	60 watts (16 ohms at 1 kHz, 10% THD)
Rear speaker:	60 + 60 watts (8 ohms at 1 kHz, 10% THD)
Sub woofer:	120 watts (8 ohms at 100 Hz, 10% THD)
Total harmonic distortion	less than 0.07% (8 ohms at 1 kHz, 35 watts)

### European model: DHC-FL7D

DIN power output at stereo mode (rated)	
	45 + 45 watts (8 ohms at 1 kHz, DIN)
Continuous RMS power output (reference)	
Front speaker:	60 + 60 watts (8 ohms at 1 kHz, 10% THD)
Center speaker:	60 watts (16 ohms at 1 kHz, 10% THD)
Rear speaker:	60 + 60 watts (8 ohms at 1 kHz, 10% THD)
Sub woofer:	120 watts (8 ohms at 100 Hz, 10% THD)
Music power output (reference)	
Front speaker:	120 + 120 watts (8 ohms at 1 kHz, 10% THD)
Center speaker:	120 watts (16 ohms at 1 kHz, 10% THD)
Rear speaker:	120 + 120 watts (8 ohms at 1 kHz, 10% THD)
Sub woofer:	240 watts (8 ohms at 100 Hz, 10% THD)

continued

## Specifications (continued)

### Other models:

#### DHC-FL7D/FL5D

The following measured at AC 127, 220, 240 V, 50/60 Hz (Saudi Arabian model only)

The following measured at AC 120, 220, 240 V, 50/60 Hz (except for Saudi Arabian model)

### MULTI mode

DIN power output at stereo mode (rated)	45 + 45 watts (8 ohms at 1 kHz, DIN)
Continuous RMS power output (reference)	
Front speaker:	60 + 60 watts (8 ohms at 1 kHz, 10% THD)
Center speaker:	60 watts (16 ohms at 1 kHz, 10% THD)
Rear speaker:	60 + 60 watts (8 ohms at 1 kHz, 10% THD)
Sub woofer:	100 watts (8 ohms at 100 Hz, 10% THD)

### 2.1CH mode

DIN power output at stereo mode (rated)	70 + 70 watts (8 ohms at 1 kHz, DIN)
Continuous RMS power output (reference)	
Front speaker:	120 + 120 watts (8 ohms at 1 kHz, 10% THD)
Sub woofer:	240 watts (8 ohms at 100 Hz, 10% THD)

### Inputs

VIDEO (MD) IN (North American model only):  
(phono jacks) voltage 250 mV/450mV  
impedance 47 kilohms

MD (VIDEO) IN (other models):  
(phono jacks) voltage 450 mV/250 mV,  
impedance 47 kilohms

OPTICAL DIGITAL IN:  
(Square optical connector jacks, rear panel)  
wavelength \_\_\_\_\_

MIC: sensitivity 1 mV,  
(phone jack) impedance 10 kilohms

Outputs  
VIDEO (MD) OUT (North American model only) or  
MD (VIDEO) OUT (other models):  
(phono jacks) voltage 250 mV  
impedance 1 kilohms

VIDEO OUT: 1 V<sub>p-p</sub>, 75 ohms  
S-VIDEO OUT: Y: 1 V<sub>p-p</sub>, 75 ohms  
C: 0.286V<sub>p-p</sub>, 75 ohms

COMPONENT OUT: Y: 1 V<sub>p-p</sub>, 75 ohm  
Pb: 0.7 V<sub>p-p</sub>, 75 ohms  
Pr: 0.7 V<sub>p-p</sub>, 75 ohms

PHONES:  
(stereo mini jack) accepts headphones of  
8 ohms or more

FRONT L/R: Use only the supplied  
speaker SS-FL7

REAR L/R: Use only the supplied  
speaker SS-RS7

CENTER: Use only the supplied  
speaker SS-CT7

S.WOOFER: Use only the supplied  
speaker SS-WG7

## DVD player section

Laser Semiconductor laser  
(DVD:  $\lambda=650$  nm,  
CD:  $\lambda=780$  nm)  
Emission duration:  
continuous

Frequency response DVD (PCM 48 kHz):  
2 Hz – 22 kHz ( $\pm 1$  dB)  
CD: 2 Hz – 20 kHz =  
( $\pm 1$  dB)

Signal-to-noise ratio More than 90 dB

Dynamic range More than 90 dB

Video color system format NTSC, PAL

OPTICAL DVD DIGITAL OUT  
(Square optical connector jack, rear panel)  
wavelength 660 nm

## Tape player section

Recording system 4-track 2-channel stereo  
Frequency response 50 – 13,000 Hz ( $\pm 3$  dB),  
using Sony TYPE I  
cassette

Wow and flutter  $\pm 0.15\%$  W.Peak (IEC)  
0.1% W.RMS (NAB)  
 $\pm 0.2\%$  W.Peak (DIN)

## Tuner section

FM stereo, FM/AM superheterodyne tuner

### FM tuner section

Tuning range  
North American model: 87.5 - 108.0 MHz  
(100-kHz step)

Other models: 87.5 - 108.0 MHz  
(50-kHz step)

Antenna FM lead antenna  
Antenna terminals 75 ohm unbalanced  
Intermediate frequency 10.7 MHz

## AM tuner section

### Tuning range

Pan American model: 530 - 1,710 kHz  
(with the tuning interval set at 10 kHz)  
531 - 1,710 kHz  
(with the tuning interval set at 9 kHz)

European, Middle Eastern models:  
531 - 1,602 kHz  
(with the tuning interval set at 9 kHz)

Other models:  
530 - 1,710 kHz  
(with the tuning interval set at 10 kHz)  
531 - 1,602 kHz  
(with the tuning interval set at 9 kHz)

Antenna  
Antenna terminals  
Intermediate frequency  
450 kHz

## Speaker

### Front speaker SS-FL7

Speaker system  
2-way, 3-unit,  
bass-reflex type,  
magnetically shielded type

Speaker units  
Woofer: 13 cm, cone type  
Tweeter: 5 cm, cone type  
Nominal impedance  
8 ohms  
Dimensions (w/h/d)  
Approx. 245 × 425 × 320 mm  
Mass  
Approx. 6.3 kg net per speaker

### Rear speaker SS-RS7

Speaker system  
2-way, 2-unit,  
bass-reflex type

Speaker units  
8 cm, cone type,  
4 cm, cone type

Nominal impedance  
8 ohms  
Dimensions (w/h/d)  
Approx. 100 × 250 × 145 mm  
Mass  
Approx. 1.2 kg net per speaker

### Center speaker SS-CT7

Speaker system  
2-way, 2-unit,  
bass-reflex type,  
magnetically shielded type

Speaker units  
8 cm, cone type,  
5 cm, cone type

Nominal impedance  
16 ohms  
Dimensions (w/h/d)  
Approx. 100 × 250 × 145 mm  
Mass  
Approx. 1.2 kg net

## Sub woofer SS-WG7

Speaker system  
Passive sub woofer,  
magnetically shielded

Speaker units  
Woofer: 18 cm, cone type  
Nominal impedance  
8 ohms  
Dimensions (w/h/d)  
Approx. 245 × 410 × 420 mm  
Mass  
Approx. 9.5 kg net

## General

Power requirements  
North American model: 120 V AC, 60 Hz  
European model: 120 -127 V, 220 V or 230 - 240 V AC, 50/60 Hz  
Saudi Arabian model: Adjustable with voltage selector  
230 - 240V AC, 50/60 Hz  
Thailand model: 220 V AC, 50/60 Hz  
Korean model: 220 V AC, 60 Hz  
Mexican model: 120 V AC, 60 Hz  
Other models: 120 V, 220 V or 230 - 240 V AC, 50/60 Hz  
Adjustable with voltage selector

## Power consumption

U.S.A. model:  
DHC-FL7D 325 watts  
Canadian model:  
DHC-FL7D 325 watts  
European model:  
DHC-FL7D 325 watts  
0.3 watts (at the Power Saving Mode)

Other models:  
DHC-FL7D 425 watts  
DHC-FL5D 425 watts

Dimensions (w/h/d) Approx. 245 × 410 × 400 mm

## Mass

North American and European models:  
DHC-FL7D Approx. 14 kg  
Other models:  
DHC-FL7D Approx. 15 kg  
DHC-FL5D Approx. 15 kg

Supplied accessories:  
AM loop antenna (1)  
FM lead antenna (1)  
Remote commander (1)  
Batteries (3)  
Video cable (1)  
Speaker cord (6)  
Speaker support (2)  
Screw ⊕ 3 × 10 (8)  
Stand (2 for U.S.A. model only)  
Center and rear speaker pads (12)

Design and specifications are subject to change without notice.

## Glossary

### **Album**

Section of a music piece on a data CD containing MP3 audio tracks.

### **Bit Rate**

Value indicating the amount of video data compressed in a DVD per second. The unit is Mbps (Mega bit per second). 1 Mbps indicates that the data per second is 1,000,000 bits. The higher the bit rate is, the larger the amount of data. However, this does not always mean that you can get higher quality pictures.

### **Chapter**

Sections of a picture or a music piece on a DVD that are smaller than titles. A title is composed of several chapters.

### **Dolby Digital**

This sound format for movie theaters is more advanced than Dolby Pro Logic Surround. In this format, the rear speakers output stereo sound with an expanded frequency range and a subwoofer channel for deep bass is independently provided. This format is also called "5.1" because the subwoofer channel is counted as 0.1 channel (since it functions only when a deep bass effect is needed). All six channels in this format are recorded separately to realize superior channel separation. Furthermore, since all the signals are processed digitally, less signal degradation occurs.

### **Dolby Pro Logic II**

Dolby Pro Logic II creates five full-bandwidth output channels from two-channel sources. This is done using an advanced, high-purity matrix surround decoder that extracts the spatial properties of the original recording without adding any new sounds or tonal colorations.

### **Dolby Pro Logic Surround**

As one method of decoding Dolby Surround, Dolby Pro Logic Surround produces four channels from two-channel sound. Compared with the former Dolby Surround system, Dolby Pro Logic Surround reproduces left-to-right panning more naturally and localizes sounds more precisely. To take full advantage of Dolby Pro Logic Surround, you should have one pair of rear speakers and a centre speaker. The rear speakers output monaural sound.

### **DTS**

Digital audio compression technology that the Digital Theater Systems, Inc. developed. This technology conforms to 5.1-channel surround. The rear channel is stereo and there is discrete subwoofer channel in this format. DTS provides the same 5.1 discrete channels of high quality digital audio. The good channel separation is realized because the all channel data is recorded discrete and processed in digital.

### **DVD**

A disc that contains up to 8 hours of moving pictures even though its diameter is the same as a CD.

The data capacity of a single-layer and single-sided DVD, at 4.7 GB (Giga Byte), is 7 times that of a CD. Furthermore, the data capacity of a dual-layer and single-sided DVD is 8.5 GB, a single-layer and double-sided DVD 9.4 GB, and a dual-layer and double-sided DVD 17 GB.

The picture data uses the MPEG 2 format, one of the worldwide standards of digital compression technology. The picture data is compressed to about 1/40 of its original size. The DVD also uses the variable rate coding technology that changes the data to be allocated according to the status of the picture.

The audio data is recorded in Dolby Digital as well as in PCM, allowing you to enjoy more real audio presence. Furthermore, various advanced functions such as the multi-angle, multilingual, and Parental Control functions are provided with the DVD.

### **Index (CD) / Video Index (VIDEO CD)**

A number that divides a track into sections to easily locate the point you want on a VIDEO CD or a CD. Depending on the disc, no indexes may be recorded.

### **Multi-angle function**

Various angles, or viewpoints of the video camera, for a scene are recorded on some DVDs.

### **Multilingual function**

Several languages for the sound or subtitles in a picture are recorded on some DVDs.

### **Parental Control**

A function of the DVD to limit playback of the disc by the age of the users according to the limitation level in each country. The limitation varies from disc to disc; when it is activated, playback is completely prohibited, violent scenes are skipped or replaced with other scenes and so on.

### **Playback Control (PBC)**

Signals encoded on VIDEO CDs (Version 2.0) to control playback. By using menu screens recorded on VIDEO CDs with PBC functions, you can enjoy playing simple interactive programs, programs with search functions, and so on.

### **Progressive format**

Compared to the Interlace format that alternately shows every other line of an image (field) to create one frame, the Progressive format shows the entire image at once as a single frame. This means that while the Interlace format can show 30 frames (60 fields) in one second, the Progressive format can show 60 frames in one second. The overall picture quality increases and still images, text, and horizontal lines appear sharper. This player is compatible with the 480 progressive format.

### **Region Code**

This system is used to protect copyrights. A region number is allocated on each DVD system or DVD disc according to the sales region. Each region code is shown on the system as well as on the disc packaging. The system can play the discs that match its region code. The system can also play discs with the “” mark. Even when the region code is not shown on the DVD, the region limit may still be activated.

### **Scene**

On a VIDEO CD with PBC functions (page 25), the menu screens, moving pictures, and still pictures are divided into sections called “scenes”.

### **Super Audio CD (SACD)**

This audio format is based upon the current audio CD standards but includes a greater amount of information which provides higher quality sound. There are three types of discs: single layer, double layer and hybrid discs. The hybrid disc contains both standard audio CD and Super Audio CD information.

### **Title**

The longest sections of a picture or a music piece on a DVD; a movie, etc., for a picture piece on video software; or an album, etc., for a music piece on an audio software.

**continued**

## Glossary (continued)

### Track

Sections of a picture or a music piece on a CD, VIDEO CD, Super Audio CD or MP3.

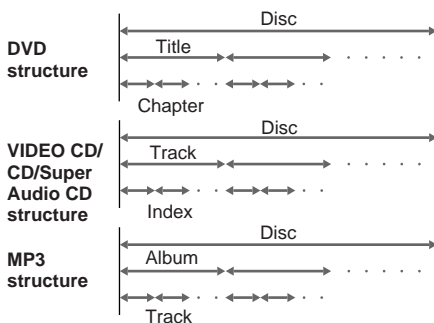

### VIDEO CD

A compact disc that contains moving pictures.

The picture data uses the MPEG 1 format, one of the worldwide standards of digital compression technology. The picture data is compressed to about 1/140 of its original size. Consequently, a 12 cm VIDEO CD can contain up to 74 minutes of moving pictures.

VIDEO CDs also contain compact audio data. Sounds outside the range of human hearing are compressed while the sounds we can hear are not compressed. VIDEO CDs can hold 6 times the audio information of conventional audio CDs.

There are 2 versions of VIDEO CDs.

- Version 1.1: You can play only moving pictures and sounds.
- Version 2.0: You can play high-resolution still pictures and enjoy PBC functions.

This system conforms to both versions.



# Language code list

For details, see pages 27, 33 and 36.

The language spellings conform to the ISO 639: 1988 (E/F) standard.

Code	Language	Code	Language	Code	Language	Code	Language
1027	Afar	1186	Scots Gaelic	1350	Malayalam	1513	Siswati
1028	Abkhazian	1194	Galician	1352	Mongolian	1514	Sesotho
1032	Afrikaans	1196	Guarani	1353	Moldavian	1515	Sundanese
1039	Amharic	1203	Gujarati	1356	Marathi	1516	Swedish
1044	Arabic	1209	Hausa	1357	Malay	1517	Swahili
1045	Assamese	1217	Hindi	1358	Maltese	1521	Tamil
1051	Aymara	1226	Croatian	1363	Burmese	1525	Telugu
1052	Azerbaijani	1229	Hungarian	1365	Nauru	1527	Tajik
1053	Bashkir	1233	Armenian	1369	Nepali	1528	Thai
1057	Byelorussian	1235	Interlingua	1376	Dutch	1529	Tigrinya
1059	Bulgarian	1239	Interlingue	1379	Norwegian	1531	Turkmen
1060	Bihari	1245	Inupiak	1393	Occitan	1532	Tagalog
1061	Bislama	1248	Indonesian	1403	(Afan) Oromo	1534	Setswana
1066	Bengali; Bangla	1253	Icelandic	1408	Oriya	1535	Tonga
1067	Tibetan	1254	Italian	1417	Punjabi	1538	Turkish
1070	Breton	1257	Hebrew	1428	Polish	1539	Tsonga
1079	Catalan	1261	Japanese	1435	Pashto; Pushto	1540	Tatar
1093	Corsican	1269	Yiddish	1436	Portuguese	1543	Twi
1097	Czech	1283	Javanese	1463	Quechua	1557	Ukrainian
1103	Welsh	1287	Georgian	1481	Rhaeto-Romance	1564	Urdu
1105	Danish	1297	Kazakh	1482	Kirundi	1572	Uzbek
1109	German	1298	Greenlandic	1483	Romanian	1581	Vietnamese
1130	Bhutani	1299	Cambodian	1489	Russian	1587	Volapük
1142	Greek	1300	Kannada	1491	Kinyarwanda	1613	Wolof
1144	English	1301	Korean	1495	Sanskrit	1632	Xhosa
1145	Esperanto	1305	Kashmiri	1498	Sindhi	1665	Yoruba
1149	Spanish	1307	Kurdish	1501	Sangho	1684	Chinese
1150	Estonian	1311	Kirghiz	1502	Serbo-Croatian	1697	Zulu
1151	Basque	1313	Latin	1503	Singhalese	1703	Not specified
1157	Persian	1326	Lingala	1505	Slovak		
1165	Finnish	1327	Laothian	1506	Slovenian		
1166	Fiji	1332	Lithuanian	1507	Samoan		
1171	Faroese	1334	Latvian; Lettish	1508	Shona		
1174	French	1345	Malagasy	1509	Somali		
1181	Frisian	1347	Maori	1511	Albanian		
1183	Irish	1349	Macedonian	1512	Serbian		

## Control Menu Item List

Control Menu Items	Function
<b>DISC NAME</b>	Displays the disc name inserted into the system.
<b>TITLE</b> (DVD only) <b>SCENE</b> (VIDEO CD in PBC Playback only) <b>TRACK</b> (VIDEO CD only)	Selects the title (DVD) or the track (VIDEO CD) to be played.
<b>CHAPTER</b> (DVD only) <b>INDEX</b> (VIDEO CD only)	Selects the chapter (DVD) or the index (VIDEO CD) to be played.
<b>ALBUM</b> (MP3 only)	Selects the album (MP3) to be played.
<b>TRACK</b> (Super Audio CD/CD/ MP3 only)	Selects the track to be played.
<b>INDEX</b> (Super Audio CD/CD only)	Selects the index to be played.
<b>TIME/TEXT</b>	Checks the elapsed time and the remaining playback time. Input the time code for picture and music searching.
<b>AUDIO</b> (DVD/VIDEO CD/ Super Audio CD/CD only)	Changes the audio setting.
<b>SUBTITLE</b> (DVD only)	Displays the subtitles. Changes the subtitle language.
<b>ANGLE</b> (DVD only)	Changes the angle.
<b>PLAY MODE</b> (VIDEO CD/ Super Audio CD/CD/MP3 only)	Selects the play mode.
<b>REPEAT</b>	Plays the entire disc (all titles/all tracks) repeatedly or one title/chapter/track repeatedly.
<b>CUSTOM PARENTAL CONTROL</b>	Sets the disc to prohibit playback.

### Tips

- Each time you press DVD DISPLAY, the Control Menu display changes cyclically as follows.  
Control Menu display → Control Menu display off  
The Control Menu items differ depending on the disc.
- The Control Menu icon indicator lights in green when you select any item except for “OFF” (“REPEAT” only).  
The “ANGLE” indicator lights in green only when the angles can be changed.

# Setup Display Item List

You can set the following items in the Setup Display.

The order of the displayed items may be different from the actual display.

## LANGUAGE SETUP

- OSD — (Select the language you want to use from the displayed language list.)
- DVD MENU — (Select the language you want to use from the displayed language list.)
- AUDIO — (Select the language you want to use from the displayed language list.)
- SUBTITLE — (Select the language you want to use from the displayed language list.)

## CUSTOM SETUP

- COLOR\* SYSTEM — AUTO, PAL, NTSC
- PARENTAL CONTROL — LEVEL — OFF, 8., 7. NC17, 6. R, 5., 4. PG13, 3. PG, 2., 1. G
  - STANDARD — USA, OTHERS →
  - CHANGE PASSWORD
- TRACK SELECTION — OFF, AUTO

## SCREEN SETUP

- TV TYPE — 16:9, 4:3 LETTER BOX, 4:3 PAN SCAN
- SCREEN SAVER — ON, OFF
- BACKGROUND — JACKET, PICTURE, GRAPHICS, BLUE, BLACK
- COMPONENT OUT — INTERLACE, PROGRESSIVE

## SPEAKER SETUP

- SIZE — FRONT — YES, CENTER — YES
  - REAR — BEHIND — LOW, HIGH, SIDE — LOW, HIGH
  - SUBWOOFER — YES
- DISTANCE\*\* — FRONT — 1.0m ~12m/ 3ft ~ 40ft, CENTER — 0m ~12m/ 0ft ~ 40ft, REAR — 0m ~12m/ 0ft ~ 40ft
- LEVEL — CENTER — -6 dB ~ +6 dB, REAR — -6 dB ~ +6 dB, SUBWOOFER — -6 dB ~ +6 dB
- BALANCE — FRONT — 6 steps left or right, REAR — 6 steps left or right
- TEST TONE — OFF, ON

## RESET

- YES

\* Except for Pan American and European models.

\*\* In SPEAKER SETUP, the North American model's OSD displays both metric and imperial measurements. The other model's displays metric measurements only. The manual also shows both.

