

# DVD Home Theatre System

Operating Instructions

DAV-DZ330/DZ730



**HDMI**



SUPER AUDIO CD



**MP3**

## WARNING

### Caution – The use of optical instruments with this product will increase eye hazard.

Do not install the appliance in a confined space, such as a bookcase or built-in cabinet.

To reduce the risk of fire, do not cover the ventilation opening of the apparatus with newspapers, tablecloths, curtains, etc. Do not place the naked flame sources such as lighted candles on the apparatus. To reduce the risk of fire or electric shock, do not expose this apparatus to dripping or splashing, and do not place objects filled with liquids, such as vases, on the apparatus.

Do not expose batteries or apparatus with battery-installed to excessive heat such as sunshine, fire or the like.

To prevent injury, this apparatus must be securely attached to the floor/wall in accordance with the installation instructions.

Indoor use only.

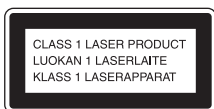

This appliance is classified as a CLASS 1 LASER product. This marking is located on the rear exterior.



### Disposal of Old Electrical & Electronic Equipment (Applicable in the European

### Union and other European countries with separate collection systems)

This symbol on the product or on its packaging indicates that this

product shall not be treated as household waste. Instead it shall be handed over to the applicable collection point for the recycling of electrical and electronic equipment. By ensuring this product is disposed of correctly, you will help prevent potential negative consequences for the environment and human health, which could otherwise be caused by inappropriate waste handling of this product. The recycling of materials will help to conserve natural resources. For more detailed information about recycling of this product, please contact your local Civic Office, your household waste disposal service or the shop where you purchased the product.



### Disposal of waste batteries (applicable in the European

### Union and other European countries with separate collection systems)

This symbol on the battery or on the packaging indicates that the battery provided with this product shall not be treated as household waste. On certain batteries this symbol might be used in combination with a chemical symbol. The chemical symbols for mercury (Hg) or lead (Pb) are added if the battery contains more than 0.0005% mercury or 0.004% lead. By ensuring these batteries are disposed of correctly, you will help prevent potentially negative consequences for the environment and human health which could otherwise be caused by inappropriate waste handling of the battery. The recycling of the materials will help to conserve natural resources. In case of products that for safety, performance or data integrity reasons require a permanent connection with an incorporated

battery, this battery should be replaced by qualified service staff only. To ensure that the battery will be treated properly, hand over the product at end-of-life to the applicable collection point for the recycling of electrical and electronic equipment. For all other batteries, please view the section on how to remove the battery from the product safely. Hand the battery over to the applicable collection point for the recycling of waste batteries. For more detailed information about recycling of this product or battery, please contact your local Civic Office, your household waste disposal service or the shop where you purchased the product.

Notice for customers: the following information is only applicable to equipment sold in countries applying EU directives.

The manufacturer of this product is Sony Corporation, 1-7-1 Konan Minato-ku Tokyo, 108-0075 Japan. The Authorized Representative for EMC and product safety is Sony Deutschland GmbH, Hedelfinger Strasse 61, 70327 Stuttgart, Germany. For any service or guarantee matters, please refer to the addresses given in separate service or guarantee documents.

„Nadzór nad dystrybucją na terytorium Rzeczypospolitej Polskiej sprawuje Sony Poland, 00-876 Warszawa, ul. Ogrodowa 58”

# Precautions

## On power sources

- The unit is not disconnected from the mains as long as it is connected to the AC outlet, even if the unit itself has been turned off.
- As the main plug is used to disconnect the unit from the mains, connect the unit to an easily accessible AC outlet. Should you notice an abnormality in the unit, disconnect the main plug from the AC outlet immediately.

## Copyrights

This product incorporates copyright protection technology that is protected by U.S. patents and other intellectual property rights. Use of this copyright protection technology must be authorized by Macrovision, and is intended for home and other limited viewing uses only unless otherwise authorized by Macrovision. Reverse engineering or disassembly is prohibited.

This system incorporates with Dolby\* Digital and Dolby Pro Logic (II) adaptive matrix surround decoder and the DTS\*\* Digital Surround System.

- \* Manufactured under license from Dolby Laboratories. Dolby, Pro Logic, and the double-D symbol are trademarks of Dolby Laboratories.
- \*\* Manufactured under license under U.S. Patent #'s: 5,451,942; 5,956,674; 5,974,380; 5,978,762; 6,487,535 & other U.S. and worldwide patents issued & pending. DTS

and DTS Digital Surround are registered trademarks and the DTS logos and Symbol are trademarks of DTS, Inc. © 1996-2008 DTS, Inc. All Rights Reserved.

This system incorporates High-Definition Multimedia Interface (HDMI™) technology. HDMI, the HDMI logo and High-Definition Multimedia Interface are trademarks or registered trademarks of HDMI Licensing LLC.

“DVD-RW,” “DVD-R,” “DVD+RW,” “DVD+R,” “DVD VIDEO,” and the “CD” logos are trademarks.

“BRAVIA” is a trademark of Sony Corporation.

“PLAYSTATION” is a trademark of Sony Computer Entertainment Inc.

**ABOUT DIVX VIDEO:**  
DivX® is a digital video format created by DivX, Inc. This is an official DivX Certified device that plays DivX video. Visit [www.divx.com](http://www.divx.com) for more information and software tools to convert your files into DivX video.  
(Except for United Kingdom and North American models.)

**ABOUT DIVX VIDEO-ON-DEMAND:**  
This DivX Certified® device must be registered in order to play DivX Video-on-Demand (VOD) content. To generate the registration code, locate the DivX VOD section in the device setup menu. Go to [www.divx.com/vod](http://www.divx.com/vod) with this

code to complete the registration process and learn more about DivX VOD.  
(Except for United Kingdom and North American models.)

DivX® is a registered trademark of DivX, Inc., and is used under license.  
(Except for United Kingdom and North American models.)

“S-AIR” and its logo are trademarks of Sony Corporation.  
(DAV-DZ730 only)

MPEG Layer-3 audio coding technology and patents licensed from Fraunhofer IIS and Thomson.

iPod is a trademark of Apple Inc., registered in the U.S. and other countries.  
(United Kingdom models only)

“Made for iPod” means that an electronic accessory has been designed to connect specifically to iPod and has been certified by the developer to meet Apple performance standards.  
(United Kingdom models only)

Apple is not responsible for the operation of this device or its compliance with safety and regulatory standards.  
(United Kingdom models only)

## About MPEG-4 Visual

THIS PRODUCT IS LICENSED UNDER THE MPEG-4 VISUAL PATENT PORTFOLIO LICENSE FOR THE PERSONAL AND NON-COMMERCIAL USE OF A CONSUMER FOR

DECODING VIDEO IN COMPLIANCE WITH THE MPEG-4 VISUAL STANDARD (“MPEG-4 VIDEO”) THAT WAS ENCODED BY A CONSUMER ENGAGED IN A PERSONAL AND NON-COMMERCIAL ACTIVITY AND/OR WAS OBTAINED FROM A VIDEO PROVIDER LICENSED BY MPEG LA TO PROVIDE MPEG-4 VIDEO. NO LICENSE IS GRANTED OR SHALL BE IMPLIED FOR ANY OTHER USE. ADDITIONAL INFORMATION INCLUDING THAT RELATING TO PROMOTIONAL, INTERNAL AND COMMERCIAL USES AND LICENSING MAY BE OBTAINED FROM MPEG LA, LLC. SEE [HTTP://WWW.MPEGLA.COM](http://www.mpegla.com)

---

## About These Operating Instructions

- The instructions in these Operating Instructions describe the controls on the remote. You can also use the controls on the unit if they have the same or similar names as those on the remote.
- The Control Menu items may vary depending on the area.
- “DVD” may be used as a general term for a DVD VIDEO, DVD+RW/ DVD+R, and DVD-RW/ DVD-R.
- Measurements are expressed in feet (ft) for North American models.
- The default setting is underlined.
- The system is compatible with the S-AIR function, which allows transmission of sound between S-AIR products wirelessly (DAV-DZ730 only). For details of S-AIR products, see “Using an S-AIR Product” (page 53).
- Notes or instructions for the S-AIR function in these Operating Instructions refer only to DAV-DZ730, and notes or instructions for the surround amplifier or S-AIR receiver in these Operating Instructions refer only to when the surround amplifier or S-AIR receiver is used.

# Table of Contents

Precautions .....	3
About These Operating Instructions .....	4
Playable Discs/Files on a USB Device .....	6
Package Contents .....	11
Index to Parts and Control .....	12
Guide to the Control Menu .....	17

## Getting Started

<b>Step 1: Installing the System.....</b>	<b>20</b>
<b>Step 2: Connecting the System... 25</b>	<b>25</b>
<b>Step 3: Setting up the System.....</b>	<b>30</b>

## Playback

Playing a Disc .....	33
Playing Files on a Disc/USB Device ....	33
Other Playback Operations .....	35
Selecting the Playback Mode.....	39
Displaying the Information of a Disc/ USB Device .....	42
Enjoying the Audio/Video of the Connected Component .....	43

## Tuner

Presetting Radio Stations .....	46
Listening to the Radio .....	46
Using the Radio Data System (RDS).....	47

## Sound Effect

Enjoying Surround Sound.....	48
Selecting the Sound Effect.....	50

## Convenient Functions

Using the Control for HDMI Function for “BRAVIA” Sync .....	51
Using an S-AIR Product .....	53
Transferring Songs onto a USB Device .....	57
Using the sleep timer .....	59
Adjusting the Delay Between the Picture and Sound .....	59
Enjoying Multiplex Broadcast Sound .....	60
Changing the Input Level of the Sound from Connected Components .....	60



















## Settings

Changing the Brightness of the Front Panel Display.....	61
Setting the Demonstration Mode to On/Off .....	61
Reperforming the Quick Setup.....	61
Set the System to Standby Mode Automatically .....	61
Performing Further Settings .....	62

## Additional Information

Precautions.....	69
Troubleshooting.....	71
Specifications.....	77
Index .....	81

# Playable Discs/Files on a USB Device

Type	Disc logo	Characteristics	Icon
DVD VIDEO	     	<ul style="list-style-type: none"> <li>• DVD VIDEO</li> <li>• DVD-R/DVD-RW in DVD VIDEO format or video mode</li> <li>• DVD+R/DVD+RW in DVD VIDEO format</li> </ul>	
VR (Video Recording) mode	 	<ul style="list-style-type: none"> <li>• DVD-R/DVD-RW in VR (Video Recording) mode (except for DVD-R DL)</li> </ul>	
VIDEO CD		<ul style="list-style-type: none"> <li>• VIDEO CD (Ver. 1.1 and 2.0 discs)</li> <li>• Super VCD</li> <li>• CD-R/CD-RW/CD-ROM in video CD format or Super VCD format</li> </ul>	
Super Audio CD	 SUPER AUDIO CD	<ul style="list-style-type: none"> <li>• Super Audio CD</li> </ul>	
CD		<ul style="list-style-type: none"> <li>• Audio CD</li> <li>• CD-R/CD-RW in audio CD format</li> </ul>	
DATA CD	–	<ul style="list-style-type: none"> <li>• CD-R/CD-RW/CD-ROM in DATA CD format that contains the following kinds of files and conforms to ISO 9660<sup>1)</sup> Level 1/Level 2, or Joliet (extended format).               <ul style="list-style-type: none"> <li>– MP3 files<sup>2)3)</sup></li> <li>– JPEG image files<sup>4)</sup></li> <li>– DivX<sup>5)</sup>/MPEG4<sup>6)</sup> video files</li> </ul> </li> </ul>	
DATA DVD	–	<ul style="list-style-type: none"> <li>• DVD-ROM/DVD-R/DVD-RW/DVD+R/DVD+RW in DATA DVD format that contains the following kinds of files and conforms to UDF (Universal Disk Format).               <ul style="list-style-type: none"> <li>– MP3 files<sup>2)3)</sup></li> <li>– JPEG image files<sup>4)</sup></li> <li>– DivX<sup>5)</sup>/MPEG4<sup>6)</sup> video files</li> </ul> </li> </ul>	

Type	Disc logo	Characteristics	Icon
USB device	–	<ul style="list-style-type: none"> <li>• USB device that contains the following kinds of files. <ul style="list-style-type: none"> <li>– MP3 files<sup>2)3)</sup> or WMA/AAC files<sup>3)</sup></li> <li>– JPEG image files<sup>4)</sup></li> <li>– DivX<sup>5)</sup>/MPEG4<sup>6)</sup> video files</li> </ul> </li> </ul>	

<sup>1)</sup>A logical format of files and folders on CD-ROMs, defined by ISO (International Organization for Standardization).

<sup>2)</sup>MP3 (MPEG1 Audio Layer 3) is a standard format defined by ISO/MPEG for compressed audio data. MP3 files must be in MPEG1 Audio Layer 3 format.

<sup>3)</sup>Files with copyright protection (Digital Rights Management) cannot be played by the system.

<sup>4)</sup>JPEG image files must conform to the DCF image file format. (DCF “Design rule for Camera File system”: Image standards for digital cameras regulated by Japan Electronics and Information Technology Industries Association (JEITA).)

<sup>5)</sup>Except for United Kingdom and North American models.

<sup>6)</sup>Except for North American models.

## Notes on discs

This product is designed to playback discs that conform to the Compact Disc (CD) standard. DualDiscs and some music discs encoded with copyright protection technologies do not conform to the Compact Disc (CD) standard. Therefore, these discs may not be compatible with this product.

## Example of discs that the system cannot play

The system cannot play the following discs:

- CD-ROM/CD-R/CD-RW other than those recorded in the formats listed on page 6
- CD-ROM recorded in PHOTO CD format
- Data part of CD-Extra
- CD Graphics disc
- DVD Audio
- DATA CD/DATA DVD that does not contain MP3 files, JPEG image files, DivX video files\*, or MPEG4 video files\*\*
- DATA CD/DATA DVD that is created in Packet Write format
- DVD-RAM
- Blu-ray Disc
  - \* Except for United Kingdom and North American models.
  - \*\* Except for North American models.

Also, the system cannot play the following discs:

- A DVD VIDEO with a different region code (page 8)
- A disc that has a non-standard shape (e.g., card, heart)
- A disc with paper or stickers on it
- A disc that has the adhesive of cellophane tape or a sticker stuck on it

## Notes about CD-R/CD-RW/DVD-R/DVD-RW/DVD+R/DVD+RW

In some cases, CD-R/CD-RW/DVD-R/DVD-RW/DVD+R/DVD+RW cannot be played on this system due to the recording quality or physical condition of the disc, or the characteristics of the recording device and authoring software.

The disc will not play if it has not been correctly finalized. For more information, refer to the operating instructions for the recording device.

Note that some playback functions may not work with some DVD+RWs/DVD+Rs, even if they have been correctly finalized. In this case, view the disc by normal playback. Also some DATA CDs/DATA DVDs created in Packet Write format cannot be played.

## Notes about Multi Session CD

- This system can play a Multi Session CD when an MP3 file is contained in the first session. Any subsequent MP3 files recorded in later sessions can also be played.
- This system can play a Multi Session CD when a JPEG image file is contained in the first session. Any subsequent JPEG image files recorded in later sessions can also be played.
- If MP3 files and JPEG image files in music CD format or video CD format are recorded in the first session, only the first session will be played.

## Region code

Your system has a region code printed on the rear of the unit and will only play a DVD labeled with the same region code.

A DVD VIDEO labeled  will also play on this system.

If you try to play any other DVD VIDEO, the message [Playback prohibited by area limitations.] will appear on the TV screen. Depending on the DVD VIDEO, no region code indication may be given even though playing the DVD VIDEO is prohibited by area restrictions.

## Notes about playback operations of a DVD or VIDEO CD

Some playback operations on a DVD or VIDEO CD may be intentionally set by software producers. Since this system will play a DVD or VIDEO CD according to the disc contents the software producers designed, some playback features may not be available. Be sure to read the operating instructions of the DVD or VIDEO CD.

## Notes about playable files

- The system can recognize up to 200 folders, including albums (folders) that do not contain audio files, JPEG image files, or video files<sup>1)</sup>. When more than 200 folders are on the DATA CD/DATA DVD/USB device or more than 150 files are in a folder, folders/files that are recognized by the system differ depending on the folder configuration.



- The system can play the following files.

File	Extension of the file
MP3 file	“.mp3”
WMA file <sup>2)</sup>	“.wma”
AAC file <sup>2)</sup>	“.m4a”
JPEG image file	“.jpg” or “.jpeg”
DivX video file <sup>3)</sup>	“.avi” or “.divx”
MPEG4 video file <sup>1)</sup>	“.mp4” or “.m4v”

The system will attempt to play any data with the extensions above, even if it is not in MP3/WMA/AAC/JPEG/DivX<sup>3)</sup>/MPEG4<sup>1)</sup> format. Playing this data may generate a loud noise which could damage your speaker system.

- The following can increase the time it takes to start playback:
  - when a DATA CD/DATA DVD/USB device is recorded with a complicated tree structure.
  - when the audio files, JPEG image files, or video files<sup>1)</sup> in another folder have just been played.
- Some files on DATA CDs/DATA DVDs/USB devices cannot be played by the system depending on the file format.
- The system can play to a depth of 8 folders only.
- The system may not be able to play an audio file, JPEG image file, or video file<sup>1)</sup> depending on the file type.
- Files recorded by a device such as a computer may not be played in the order in which they were recorded.
- Folders that have no audio files, JPEG image files, or video files<sup>1)</sup> are skipped.
- Compatibility with all MP3/WMA/AAC encoding/writing software, recording devices, and recording media cannot be guaranteed.
- Compatibility with all MPEG4 video encoding/writing software, recording devices, and recording media cannot be guaranteed.<sup>1)</sup>
- The playback order may not be applicable depending on the software used for creating the audio file, JPEG image file, or video file<sup>1)</sup>, or if there are more than 200 folders or 150 files in each folder.

<sup>1)</sup>Except for North American models.

<sup>2)</sup>USB device only.

<sup>3)</sup>Except for United Kingdom and North American models.

## About DivX video files

### (Except for United Kingdom and North American models)

- DivX<sup>®</sup> is a video file compression technology, developed by DivX, Inc. This product is an official DivX<sup>®</sup> Certified product.
- You can play a DATA CD/DATA DVD/USB device that contains DivX<sup>®</sup> video files.

#### Note

- The system may not play a DivX video file when the file has been combined from two or more DivX video files.
- The system cannot play a DivX video file larger than 720 (width) × 576 (height) or 4GB.
- Depending on the DivX video file, sound may skip or not match the pictures on the TV screen.
- The system cannot play some DivX video files that are longer than 3 hours.
- Depending on the DivX video file, the picture may pause or be unclear, in which case it is recommended that you create the file at a lower bit rate. If the sound is noisy, MP3 is the recommended audio format.
- Because of the compression technology used for DivX video files, it may take some time after you press ► for the picture to appear.

## Notes about USB devices

- This system supports Mass Storage Class (MSC) devices.
- This system is not guaranteed to operate with all USB devices or memories.
- Although there are variety of complex functions for USB devices, the playable contents of USB devices connected to the system are music, photo, and video contents only. For details, refer to the operating instructions of the USB device.
- When a USB device is inserted, the system reads all the files on the USB device. If there are many folders or files on the USB device, it may take a long time to finish reading the USB device.
- Do not connect the system and the USB device through a USB hub.
- With some connected USB devices, there may be a delay before an operation is performed by this system.
- The playback order for the system may differ from the playback order of the connected USB device.
- Always turn off the system before removing the USB device. Removing the USB device while the system is on may corrupt the data on the USB device.
- Before using a USB device, make sure that no virus-ridden files are on the USB device.

# Package Contents

## Main unit

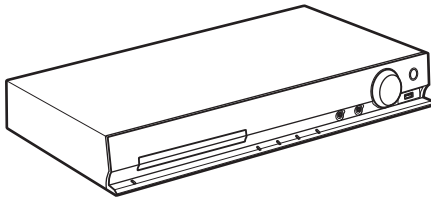

## Speaker packages

### • DAV-DZ330

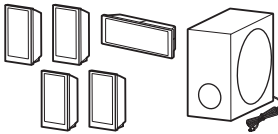

### • DAV-DZ730

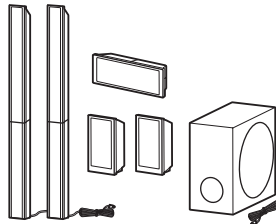

- Speaker cords (1 set)  
For DAV-DZ330 (red/  
white/green/gray/blue)  
For DAV-DZ730 (green/  
gray/blue)



### • Foot pads (1 set)



- Speaker assembly parts for the tall speakers  
For DAV-DZ730

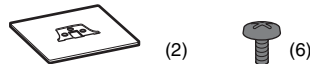

## Accessories

- Remote commander  
(remote) (1)



- R6 (size AA) batteries (2)



- Calibration mic (1)

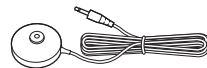

- FM wire antenna (aerial) (1)

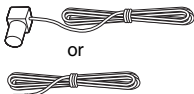

- Speaker-bottom covers (2)  
(DAV-DZ730 only)



- Operating Instructions
- Quick Setup Guide
- Speaker Installation Guide  
(DAV-DZ730 only)

# Index to Parts and Control

For more information, refer to the pages indicated in parentheses.

## Front panel

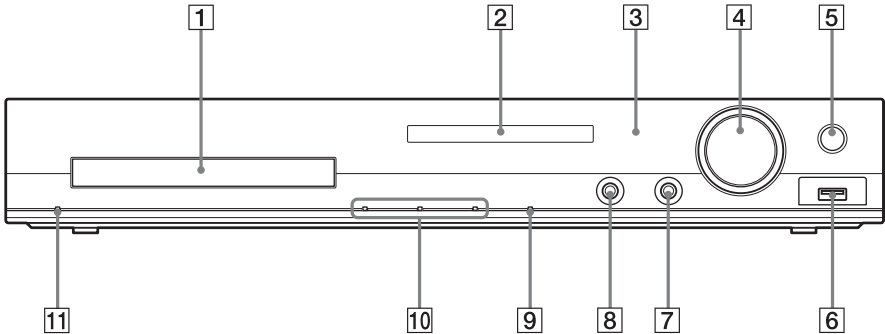

**1 Disc tray**

**2 Front panel display (page 13)**

**3  (remote sensor)**

Receives the remote signal. Point the remote toward here when using the remote.

**4 MASTER VOLUME control**

Adjusts the system's volume.

**5 REC TO USB (page 57)**

Transfers tracks/MP3 files onto a USB device.

Lights up during transfer of tracks/MP3 files.

**6  (USB) port (pages 28, 33)**

Used for connecting a USB device or iPod\*.

\* United Kingdom models only.

**7 AUDIO IN jack (page 28)**

Used for connecting other components, such as a portable audio source.

**8 A.CAL MIC jack (page 30)**

Used for connecting the calibration mic.

**9 FUNCTION**

Selects the playback source.

**10 Play operation buttons**

** (open/close)**

Opens or closes the disc tray.

** (play)**

Starts or re-starts playback.

** (stop)**

Stops playback and remembers the stop point (resume point).

**11  (on/standby)**

Turns on the unit, or sets it to standby mode.

## Front panel display

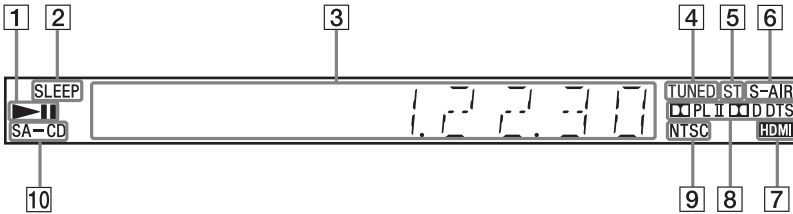

- 1 Playing status indicator**
- 2 SLEEP indicator**  
Flashes when the sleep timer is set.
- 3 System status display**
- 4 TUNED indicator (Radio only)**  
Lights up when a station is received.
- 5 ST indicator (Radio only)**  
Lights up when stereo sound is received.
- 6 S-AIR indicator (only when the wireless transmitter (not supplied) is inserted into the unit) (DAV-DZ730 only)**  
Lights up during wireless transmission.  
Flashes when “S-AIR STBY” is set to “STBY ON” and the system is in standby mode while wireless transmission between the unit and S-AIR receiver is not activated.
- 7 HDMI indicator**  
Lights up when a signal is established between a TV and the unit via HDMI.
- 8 Surround format indicator**
- 9 NTSC indicator**  
Lights up when an NTSC disc is loaded.
- 10 SA-CD indicator**  
Lights up when a Super Audio CD/CD is loaded.

## Rear panel

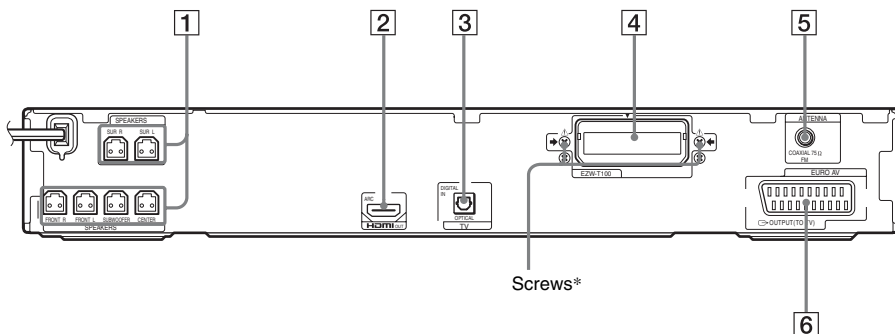

- 1 **SPEAKERS** jacks (page 25)
- 2 **HDMI OUT** jack (page 26)
- 3 **TV (DIGITAL IN OPTICAL)** jack (page 26)
- 4 **EZW-T100** slot (DAV-DZ730 only) (page 53)
- 5 **ANTENNA (COAXIAL 75Ω FM)** jack (page 28)
- 6 **EURO AV** ⇨ **OUTPUT (TO TV)** jack (page 26)

\*  **CAUTION**  
**(DAV-DZ730 only)**

Please do not remove the screws unless you are installing the EZW-T100.

## Remote control

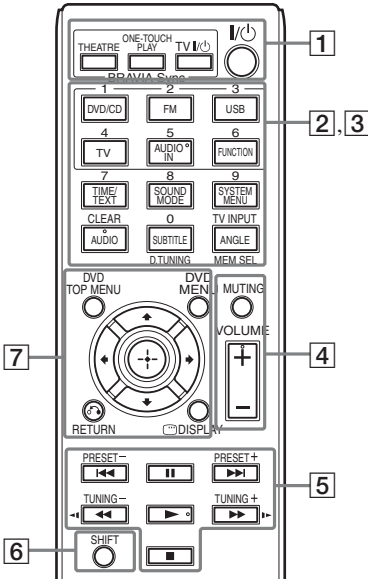

Number 5/AUDIO IN, VOLUME +, AUDIO, and ► buttons have a tactile dot. Use the tactile dot as a reference when operating the remote.

### 1 THEATRE (page 51)

Switches to the optimum video mode for watching movies automatically.

### ONE-TOUCH PLAY (page 51)

Activates One-Touch Play.

### TV I/⏻ (on/standby)\*

Turns on your TV or sets it to standby mode.

### I/⏻ (on/standby) (page 30)

Turns on the system or sets it to standby mode.

### 2 Buttons with black/white text labels

#### Function selection buttons (pages 33, 43, 46)

Select the playback source.

The system is turned on automatically when you press the function selection button while the system is turned off.

#### DVD/CD

#### FM

#### USB

#### TV

#### AUDIO IN

#### FUNCTION

Selects the functions in sequence.

#### TIME/TEXT (page 42)

Changes the information in the front panel display.

#### SOUND MODE (page 50)

Selects the sound mode.

#### SYSTEM MENU (pages 46, 48, 53, 59, 61)

Enters the system menu.

#### AUDIO (page 37)

Selects the audio format/track.

#### SUBTITLE (page 37)

Selects the subtitle language when multilingual subtitles are recorded on a DVD VIDEO.

#### ANGLE (page 37)

Switches to other viewing angles when multi-angles are recorded on a DVD VIDEO.

#### D.TUNING (page 46)

Selects the radio frequencies.

#### MEM SEL (pages 33, 57)

Selects the USB device's memory number for playback or transfer.

- 3** Buttons with pink text labels (The following buttons work when you press and hold SHIFT ([6]).)

**Number buttons (pages 36, 46)**

Enters the title/chapter numbers, radio frequencies, etc.

**CLEAR (pages 35, 39, 59)**

Clears the entry field.

**TV INPUT\***

Switches your TV's input source.

- 4** **MUTING**

Turns off the sound temporarily.

**VOLUME +/- (page 33)**

Adjusts the volume.

- 5** **Playback operation buttons**

See "Other Playback Operations" (page 35).

◀◀/▶▶ (previous/next)

◀◀/▶▶ (fast reverse/fast forward)

◀◀/▶▶ (slow)

▶ (play)

⏸ (pause)

■ (stop)

**Radio operation buttons**

See "Listening to the Radio" (page 46).

**PRESET +/-**

**TUNING +/-**

- 6** **SHIFT**

Press and hold this button to use buttons with pink text labels ([3]).

- 7** **DVD TOP MENU (page 38)**

Opens or closes the DVD's Top Menu.

**DVD MENU (page 38)**

Opens or closes the DVD's menu.

←/↑/↓/→

Moves the highlight to a displayed item.

⊕ (ENTER)

Enters the selected item.

↶ RETURN (page 34)

Returns to the previous display.

Ⓜ **DISPLAY (pages 17, 30, 33, 35, 39, 51, 57, 62)**

Displays the playback information on the TV screen.

\* Works with Sony TVs only. Depending on your TV, you may not be able to use some of the buttons.

**To insert the batteries**

Insert two R6 (size AA) batteries (supplied) by matching the ⊕ and ⊖ ends on the batteries to the markings inside the compartment.

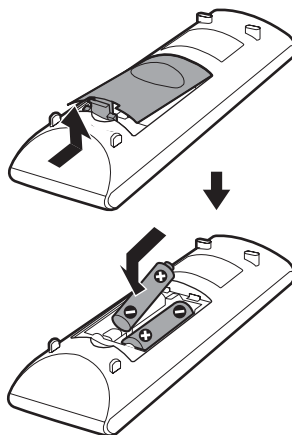

**Note**

- Do not leave the remote in an extremely hot or humid place.
- Do not use a new battery with an old one.
- Do not drop any foreign object into the remote casing, particularly when replacing the batteries.
- If you do not intend to use the remote for an extended period of time, remove the batteries to avoid possible damage from battery leakage and corrosion.



---

# Guide to the Control Menu

You can use the Control Menu to select a function and to view related information.

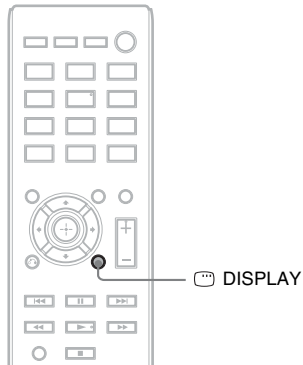

Press  DISPLAY while using the “DVD/CD” or “USB” function.

Each time you press  DISPLAY, the Control Menu changes:

① → ② → ③ → ① → ...

- ① Control Menu 1
- ② Control Menu 2 (appears when available)
- ③ Control Menu off

# Control Menu

Example: Control Menu 1 when playing a DVD VIDEO.

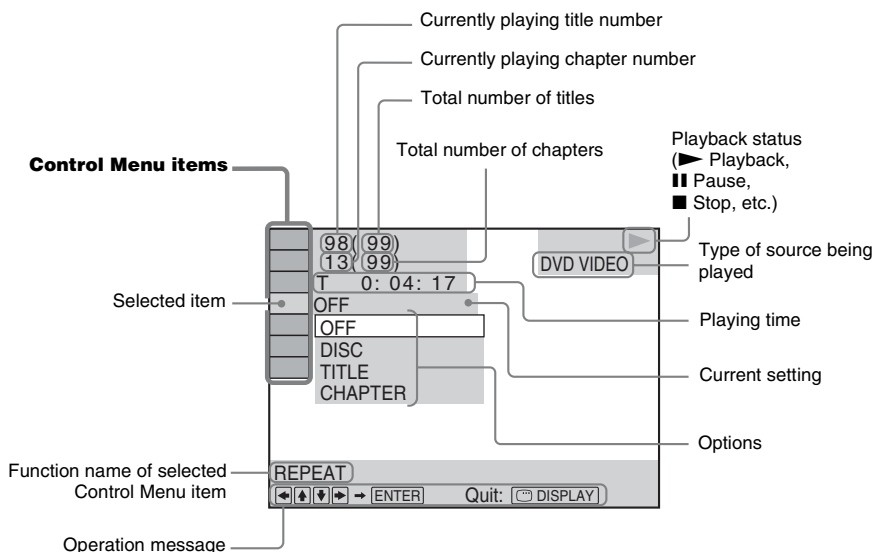

## List of Control Menu items

The Control Menu 1 and 2 will show different items depending on the source. For details, see the pages in parentheses in the chart below.

Item	Item Name, Function, Relevant Source
	<b>[TITLE] (page 36)/[SCENE] (page 36)/[TRACK] (page 36)</b> You can select the title, scene, or track to be played. <span style="float: right;">DVD-V DVD-VR VIDEO CD</span>
	<b>[CHAPTER] (page 36)/[INDEX] (page 36)</b> You can select the chapter or index to be played. <span style="float: right;">DVD-V DVD-VR VIDEO CD</span>
	<b>[INDEX] (page 36)</b> You can display the index and select the index to be played. <span style="float: right;">Super Audio CD</span>
	<b>[TRACK] (page 36)</b> You can select the track to be played. <span style="float: right;">Super Audio CD C D DATA CD DATA DVD USB</span>
	<b>[ORIGINAL/PLAY LIST] (page 38)</b> You can select the type of titles (DVD-RW/DVD-R) to be played, the [ORIGINAL] one, or an edited [PLAY LIST]. <span style="float: right;">DVD-VR</span>
	<b>[TIME] (page 36)</b> You can check the elapsed time and the remaining playback time. You can play from a desired point by inputting the time code (DVD VIDEO/DVD-VR only). <span style="float: right;">DVD-V DVD-VR VIDEO CD Super Audio CD C D DATA CD DATA DVD USB</span>
	<b>[MULTI/2CH] (page 38)</b> You can select the playback area on a Super Audio CD when available. <span style="float: right;">Super Audio CD</span>
	<b>[SUPER AUDIO CD/CD LAYER] (page 38)</b> You can select the playback layer on a Super Audio CD when available. <span style="float: right;">Super Audio CD</span>

	<b>[PROGRAM] (page 39)</b> You can select the track to play in the order you want.	VIDEO CD C D
	<b>[SHUFFLE] (page 40)</b> You can play the tracks/files in random order.	VIDEO CD Super Audio CD C D DATA CD DATA DVD USB
	<b>[REPEAT] (page 40)</b> You can play the entire disc/USB device (all titles/all tracks/all folders/all files) repeatedly or one title/chapter/track/folder/file repeatedly.	DVD-V DVD-VR VIDEO CD Super Audio CD C D DATA CD DATA DVD USB
	<b>[A/V SYNC] (page 59)</b> You can adjust the delay between the picture and sound.	DVD-V DVD-VR VIDEO CD DATA CD DATA DVD USB
	<b>[DISC MENU] (page 38)</b> You can display the DVD's menu.	DVD-V
	<b>[BROWSING] (page 34)</b> You can display the list of folders/JPEG image files.	DATA CD DATA DVD USB
	<b>[SETUP] (page 62)</b> [CUSTOM] In addition to the Quick Setup setting, you can adjust various other settings. [QUICK] (page 30) You can make basic adjustments. Use the Quick Setup to select the desired language of the on-screen display, the aspect ratio of your TV, and start the Auto Calibration.	DVD-V DVD-VR VIDEO CD Super Audio CD C D DATA CD DATA DVD USB
	<b>[FOLDER] (page 36)</b> You can select the folder to be played.	DATA CD DATA DVD USB
	<b>[FILE] (page 36)</b> You can select the JPEG image file or video file to be played.	DATA CD DATA DVD USB
1)	<b>[DATE] (page 43)</b> You can display the date the picture was taken by a digital camera.	DATA CD DATA DVD USB
1)	<b>[INTERVAL] (page 41)</b> You can select the duration for which the slides are displayed on the TV screen.	DATA CD DATA DVD USB
1)	<b>[EFFECT] (page 41)</b> You can select the effects to be used for changing slides during a slide show.	DATA CD DATA DVD USB
	<b>[MEDIA] (page 35)</b> You can select the playback priority of different types of media (MP3/AAC <sup>2</sup> /WMA <sup>2</sup> file, JPEG image file, video file, or both MP3 and JPEG image files <sup>3</sup> ) to be played on a DATA CD/DATA DVD/USB device.	DATA CD DATA DVD USB
	<b>[USB TRANSFER] (page 57)</b> You can transfer tracks on an audio CD or MP3 files on a DATA CD/DATA DVD onto a USB device.	USB

<sup>1</sup>)These items are not displayed when playing a DATA CD/DATA DVD/USB device with video files.

<sup>2</sup>)USB device only.

<sup>3</sup>)DATA CD/DATA DVD only.

**Tip**

- The Control Menu icon indicator lights up in yellow → when you select any item except [OFF] ([PROGRAM], [SHUFFLE], [REPEAT], and [A/V SYNC] only). The [ORIGINAL/PLAY LIST] indicator lights up in yellow when you select [PLAY LIST] (default setting). The [MULTI/2CH] indicator lights up in yellow when you select the multi-channel playback area on a Super Audio CD.

## Getting Started

# Step 1: Installing the System

## How to position the system

Install the system by referring to the illustration below.

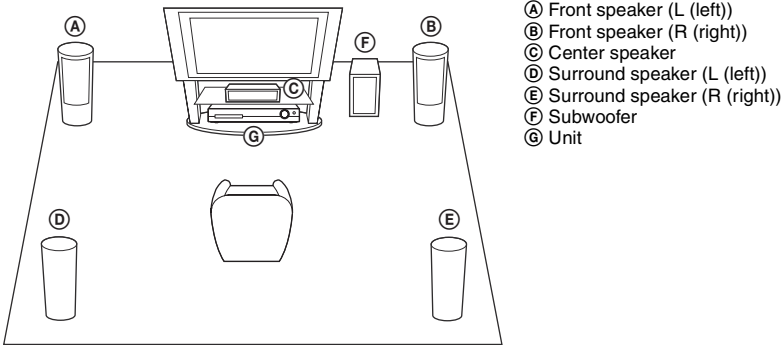

## To attach the foot pads to the subwoofer

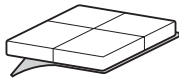

Remove the foot pads from the protective cover.

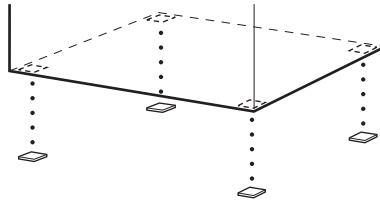

### Note

- Use caution when placing the speakers and/or speaker stands attached to the speakers on a specially treated (waxed, oiled, polished, etc.) floor, as staining or discoloration may result.

## Assembling the speakers

*(DAV-DZ730 only)*

For assembling the speakers refer to “Speaker Installation Guide” (supplement).

## When installing the speakers on a wall

### Caution

- Contact a screw shop or installer for information regarding the wall material or screws to be used.
- Use screws that are suitable for the wall material and strength. As a plaster board wall is especially fragile, attach the screws securely to a beam. Install the speakers on a vertical and flat wall where reinforcement is applied.
- Sony is not responsible for accidents or damage caused by improper installation, insufficient wall strength or improper screw installation, natural calamity, etc.

### Before installing the tall speaker on a wall (DAV-DZ730 only)

You cannot install the tall speaker with the lower part attached. Be sure to remove the lower part of the tall speaker before installing the tall speaker on a wall.

- 1 Pull out the speaker cord from the slot of the rear of the speaker.**

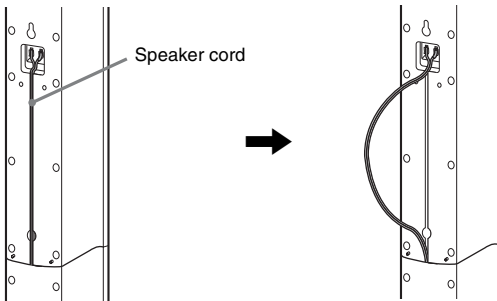

Rear of the speaker

- 2 Disconnect the speaker cords from the speaker.**

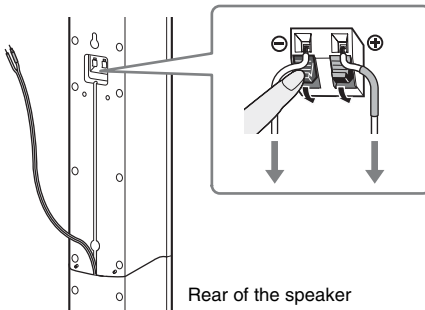

Rear of the speaker

- 3 Remove the screw (pre-installed) at the rear of the speaker.**

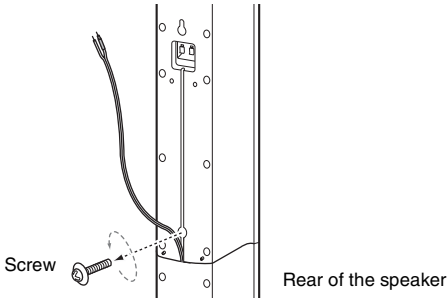

- 4 Lift the upper part of the speaker.**

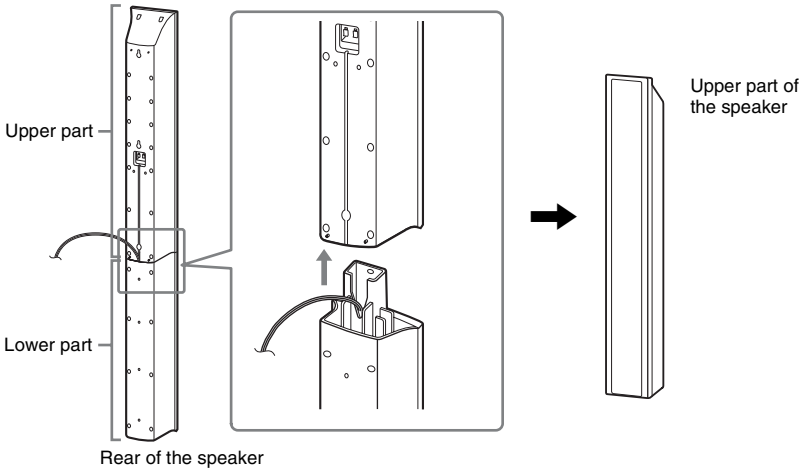

- 5 Pull out the speaker cord from the bottom of the lower part of the speaker.**

The removed speaker cord is used when installing the speaker on a wall.

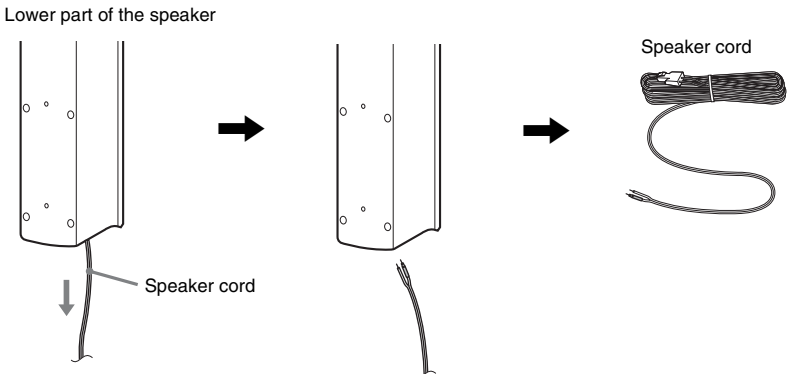

- 6** Remove the protection paper from the speaker-bottom cover, then attach the speaker-bottom cover to the bottom of the upper part of the speaker.

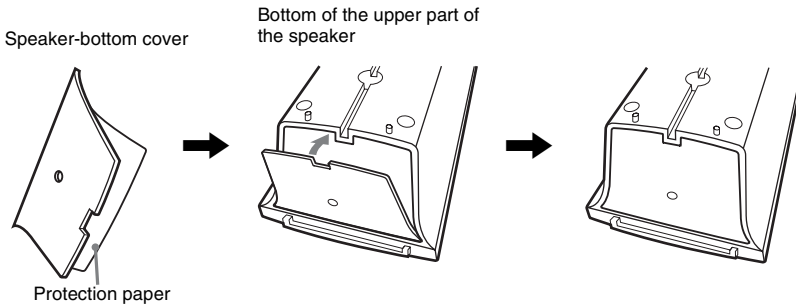
**Note**

- When removing the protection paper, pull it off via the section exposed by the notch in the speaker-bottom cover.

## To hang the speaker on a wall

- 1** Connect the speaker cord with the color tube to  $\oplus$ , and the speaker cord without the color tube to  $\ominus$ .

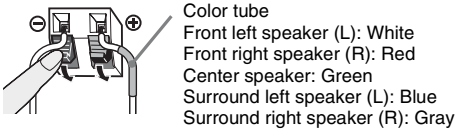

- 2** Prepare screws (not supplied) that are suitable for the hole on the back of each speaker. See the illustrations below.

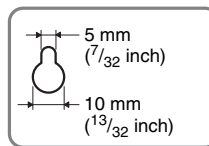
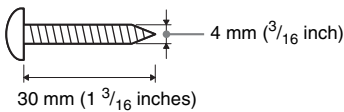

Hole on the back of the speaker

### 3 Fasten the screws to the wall, then hang the speaker on the wall.

#### Depth of fastened screw

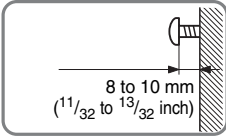

#### For the center speaker

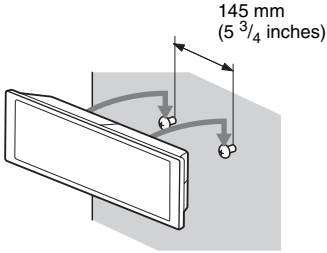

#### For the small speakers

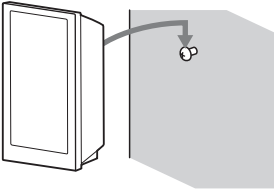

#### For the tall speakers (DAV-DZ730 only)

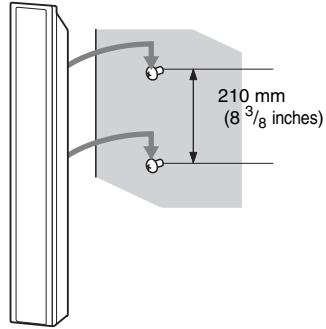



# Step 2: Connecting the System

## Connecting the speakers

- 1 Insert the connectors of the speaker cords to match the color of the **SPEAKERS** jacks of the unit until they click.

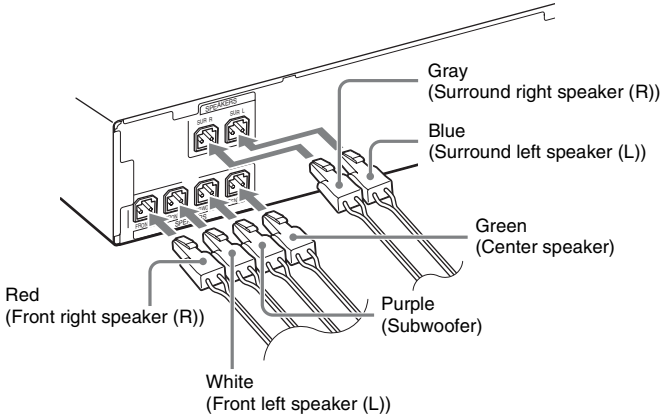

- 2 Connect the speaker cord with the color tube to  $\oplus$ , and the speaker cord without the color tube to  $\ominus$ .

The subwoofer speaker cord is fixed to the subwoofer.

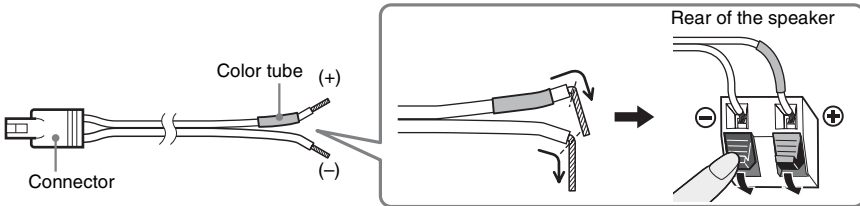

### Note

- Do not catch the speaker cord insulation (rubber covering) in the speaker terminals.

## Connecting your TV/set-top box

### When connecting to a TV only

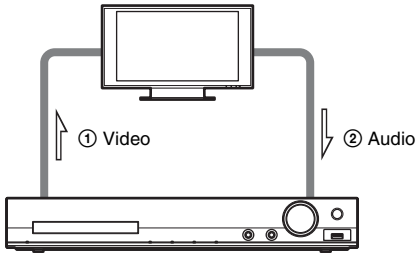

### When connecting to a TV and set-top box

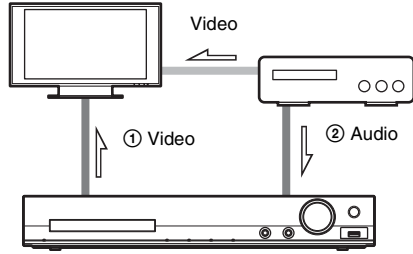

### ① Connecting the video to your TV

Depending on the jacks on your TV, select one of the connection methods.

#### ■ Method 1: SCART (EURO AV) cable (not supplied) connection

This is the basic connection and sends both video and audio signals (analog stereo).

#### ■ Method 2: HDMI cable (not supplied) connection

Picture quality will be improved compared to Method 1.

If your TV is compatible with the Audio Return Channel function, this connection also sends a digital audio signal from the TV. You do not need to make a separate audio connection for listening to TV sound. For details of the Audio Return Channel function, see “Receiving the digital audio signal of your TV” (page 52).

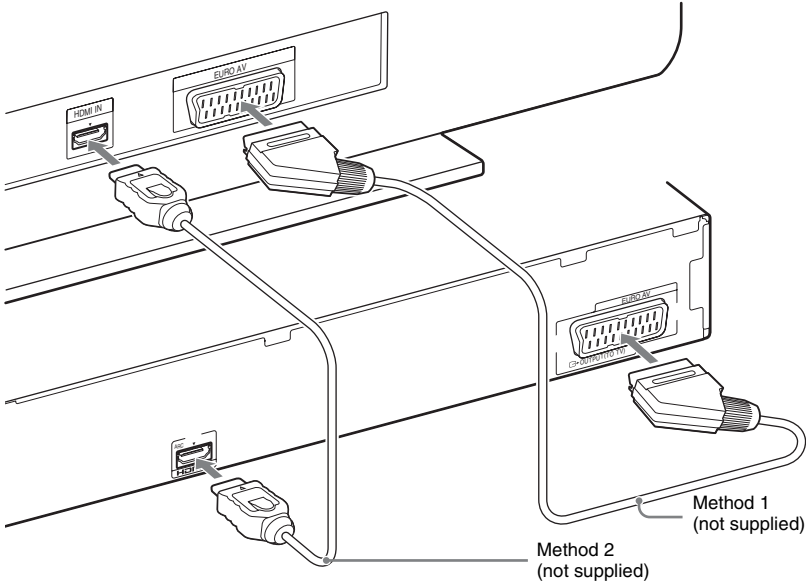

## ② Connecting the audio from your TV/set-top box

To listen to TV or set-top box sound via the system, select one of the connection methods.

### ■ Method 1: SCART (EURO AV) cable (not supplied) connection (for TV connection only)

For this connection, see Method 1 of “① Connecting the video to your TV.”

### ■ Method 2: Digital optical cord (not supplied) connection

This connection sends a digital audio signal from your TV/set-top box. To enjoy multi-channel audio, make this connection in addition to Method 1.

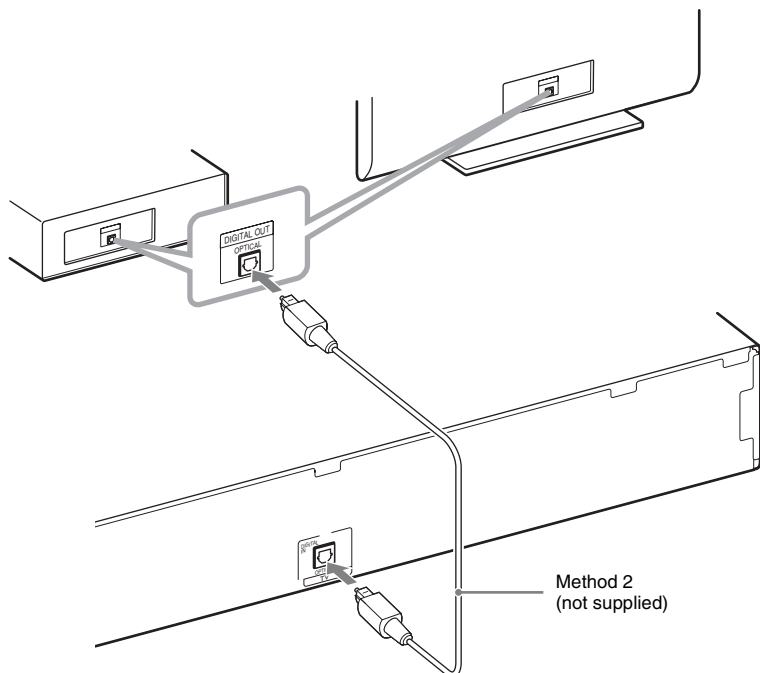

#### Note

- The system can accept both digital and analog signals. Digital signals have priority over analog signals. If the digital signal ceases, the analog signal will be processed after a few seconds.

#### Tip

- You can connect another component, such as a VCR, digital satellite receiver, or PlayStation, to the TV jack instead of your TV.

## Connecting the other components

You can enjoy connected components via the system's speakers.

Connected component	Required cord for connection
Portable audio source (not supplied)	<b>A</b> Stereo mini-plug cord (not supplied)
USB device (not supplied)	<b>B</b> USB connector (not supplied)

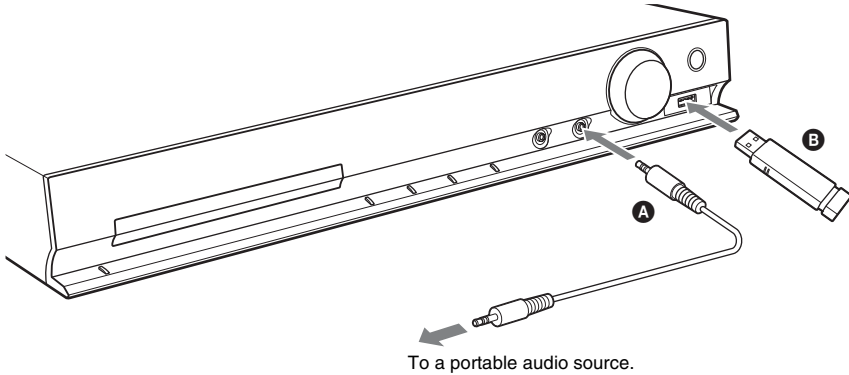

## Connecting the antenna (aerial)

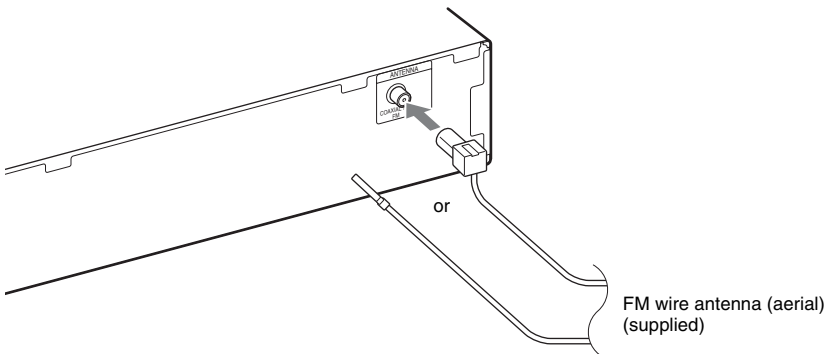

### Note

- After connecting the FM wire antenna (aerial), extend and keep it as horizontal as possible.

## Connecting the AC power cord (mains lead)

### 1 Connect the AC power cord (mains lead).

The demonstration appears in the front panel display.

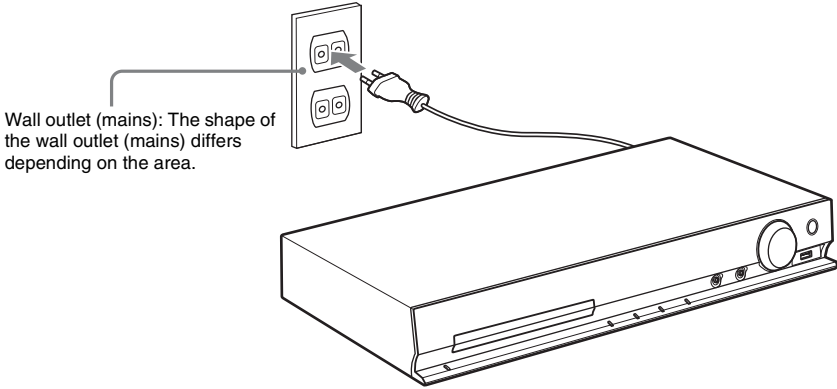

### 2 Press I/⏻ to turn the system on, then press I/⏻ again to turn off the demonstration.

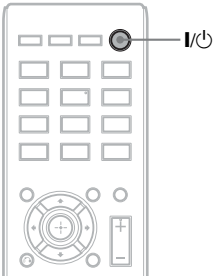

## Step 3: Setting up the System

### Performing the Quick Setup

Displayed items vary depending on the area.

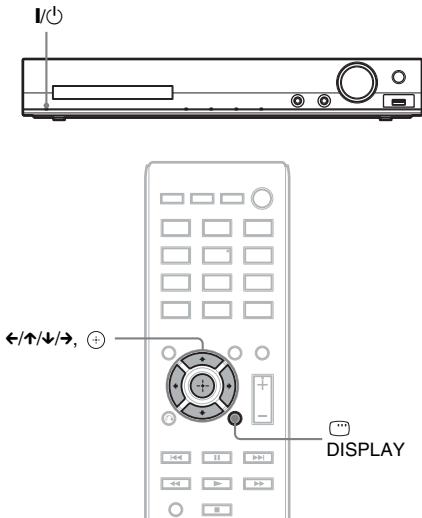

- 1 Turn on your TV.
- 2 Switch the input selector on your TV so that the signal from the system appears on the TV screen.
- 3 Press **I/⏻** to turn the system on.
- 4 Press **+** without inserting a disc or connecting a USB device.

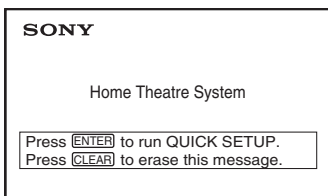

#### Note

- If this message does not appear, press DVD/CD. If this message still does not appear, recall the Quick Setup display (page 61).

- 5 Press **↑/↓** to select a language, then press **+**.

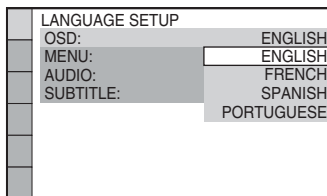

- 6 Press **↑/↓** to select the setting that matches your TV type, then press **+**.

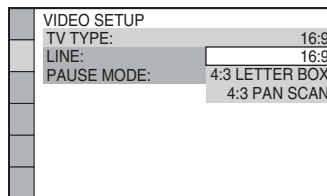

- [16:9]: This aspect ratio is for a wide-screen TV or a 4:3 standard TV with a wide-screen mode (page 63)
- [4:3 LETTER BOX] or [4:3 PAN SCAN]: This aspect ratio is for a 4:3 standard TV (page 63)

- 7 Press **↑/↓** to select the output method for video signals, then press **+**.

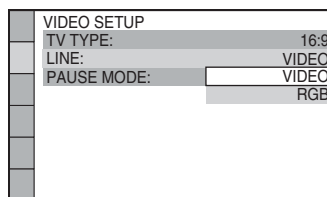

- [VIDEO]: Outputs video signals.
- [RGB]: Outputs RGB signals.

- 8 Press **↑/↓** to select the Control for HDMI setting, then press **+**.

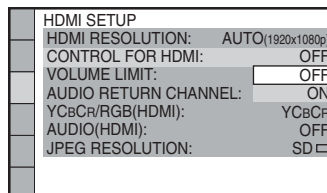

- [OFF]: The Control for HDMI function is set to off.
- [ON]: The Control for HDMI function is set to on.

**9** Press  $\leftarrow/\rightarrow$  to select the speaker formation image as the speakers are actually positioned, then press  $\oplus$ .

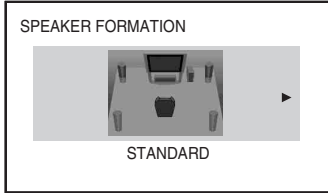

- [STANDARD]: Select this when you install all the speakers normally.
- [NO CENTER]: Select this when you install the front and surround speakers only.
- [NO SURROUND]: Select this when you install the center and front speakers only.
- [FRONT ONLY]: Select this when you install the front speakers only.
- [ALL FRONT]: Select this when you install all the speakers in front of the listening position.
- [ALL FRONT - NO CENTER]: Select this when you install the front and surround speakers in front of the listening position.

**10** Connect the calibration mic (supplied) to the A.CAL MIC jack on the front panel.

Set up the calibration mic at ear level using a tripod, etc. (not supplied).

The front of each speaker should face the calibration mic, and there should be no obstruction between the speakers and the calibration mic.

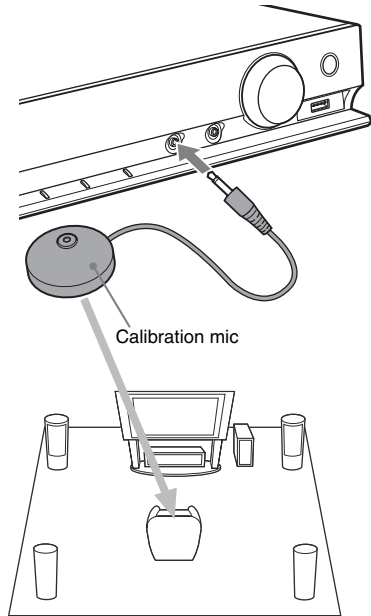

**11** Press  $\leftarrow/\rightarrow$  to select [YES], then press  $\oplus$ .

Be quiet during the measurement.

**Note**

- Loud test sounds are output when [AUTO CALIBRATION] starts. You cannot turn the volume down. Give consideration to children and neighbors.
- The environment of the room in which the system is installed may affect measurements. When the measurements differ considerably from the status of the speaker installation, perform the speaker settings manually by following "Settings for the speakers" (page 67).

**12** Unplug the calibration mic, press  $\leftarrow/\rightarrow$  to select [YES], then press  $\oplus$ .

**To quit the Quick Setup**

Press  $\square$  DISPLAY in any Step.

## Setting the type of video output to match your TV

Depending on the connection of your TV (page 26), select the type of video output of the system.

### To select the type of video signal output from the HDMI OUT jack

When you connect the unit and your TV with an HDMI cable, select the type of video signals output from the HDMI OUT jack.

#### 1 Press DVD/CD.

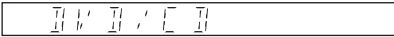

#### 2 Press DISPLAY while the system is in stop mode.

#### 3 Press $\uparrow/\downarrow$ to select [SETUP], then press $\oplus$ .

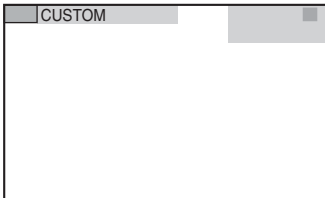

#### 4 Press $\uparrow/\downarrow$ to select [CUSTOM], then press $\oplus$ .

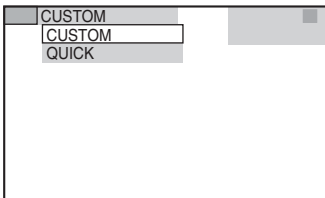

#### 5 Press $\uparrow/\downarrow$ to select [HDMI SETUP], then press $\oplus$ .

HDMI SETUP	
HDMI RESOLUTION:	AUTO(1920x1080p)
CONTROL FOR HDMI:	OFF
VOLUME LIMIT:	OFF
AUDIO RETURN CHANNEL:	AUTO
YCbCr/RGB(HDMI):	YCbCr
AUDIO(HDMI):	OFF
JPEG RESOLUTION:	SD $\square$

#### 6 Press $\uparrow/\downarrow$ to select [HDMI RESOLUTION], then press $\oplus$ .

HDMI SETUP	
HDMI RESOLUTION:	AUTO(1920x1080p)
CONTROL FOR HDMI:	OFF
VOLUME LIMIT:	OFF
AUDIO RETURN CHANNEL:	AUTO
YCbCr/RGB(HDMI):	YCbCr
AUDIO(HDMI):	OFF
JPEG RESOLUTION:	SD $\square$

#### 7 Press $\uparrow/\downarrow$ to select the desired setting, then press $\oplus$ .

HDMI SETUP	
HDMI RESOLUTION:	AUTO(1920x1080p)
CONTROL FOR HDMI:	AUTO(1920x1080p)
VOLUME LIMIT:	1920x1080i
AUDIO RETURN CHANNEL:	1280x720p
YCbCr/RGB(HDMI):	720x480p
AUDIO(HDMI):	OFF
JPEG RESOLUTION:	SD $\square$

- [AUTO (1920 × 1080p)]: The system outputs the optimal video signal for the connected TV.
  - [1920 × 1080i]: The system outputs 1920 × 1080i\* video signals.
  - [1280 × 720p]: The system outputs 1280 × 720p\* video signals.
  - [720 × 480p]\*\*: The system outputs 720 × 480p\* video signals.
- \* i: interlace, p: progressive  
 \*\* Depending on the area, [720 × 480/576p] may appear and the system may output 720 × 576p video signals.



# Playing a Disc

DVD-V DVD-VR VIDEO CD Super Audio CD CD

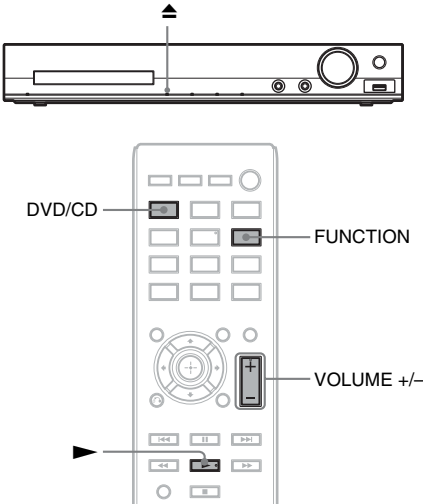

- 1** Press **DVD/CD**.  
You can also select this function by pressing **FUNCTION** repeatedly.
- 2** Press **▲** to open the disc tray.
- 3** Place a disc on the tray, then press **▲**.

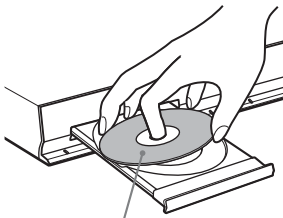

With the label side up.

- 4** Press **▶** to start playback.
- 5** Press **VOLUME +/-** to adjust the volume.

# Playing Files on a Disc/USB Device

DATA CD DATA DVD USB

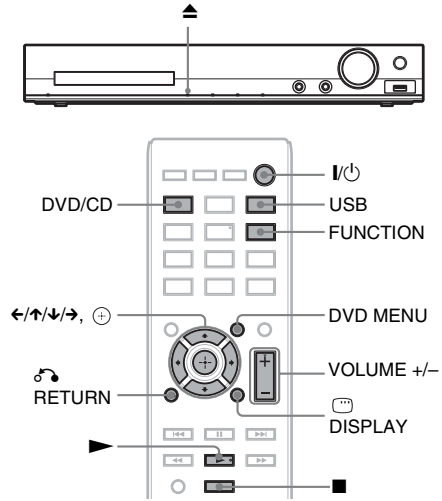

- 1** Press **DVD/CD** or **USB**.
  - **DVD/CD**: For a disc.
  - **USB**: For a USB device.
 You can also select the function by pressing **FUNCTION** repeatedly.
- 2** Load the source.
  - **For a disc**  
Place a disc on the tray by pressing **▲** to open/close the disc tray.
  - **For a USB device**  
Connect a USB device to the **↔** (USB) port.

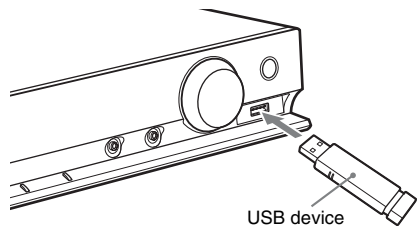

**Note**

- It may take about 10 seconds before “READING” appears in the front panel display depending on the type of USB device.

[FOLDER LIST] appears on the TV screen. If [FOLDER LIST] does not appear, press DVD MENU.

**3 Press  $\uparrow/\downarrow$  to select a folder.****4 Press  $\blacktriangleright$  to start playback.****■ For video or audio files**

The system starts playback of files in the selected folder.

**■ For JPEG image files**

The system starts a slide show of files in the selected folder.

**5 Press VOLUME +/- to adjust the volume.****To select the playback source of the USB device**

You can select the memory number for playback depending on the USB device.

**Press MEM SEL.**

Selected memory number

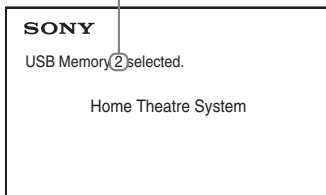
**Note**

- When the memory cannot be selected, [Operation not possible.] appears on the TV screen.
- The memory number changes depending on the USB device.

**To remove the USB device**

- 1** Press  $\blacksquare$  to stop playback.
- 2** Press  $I/\odot$  to turn off the system.
- 3** Remove the USB device.

**Playing a specific file**

**DATA CD** **DATA DVD** **USB**

**1 Select a folder by following Steps in “Playing Files on a Disc/USB Device” (page 33).****2 Press  $\oplus$  to display the file list.****3 Select a file.**

To return to the folder list, press  $\delta$  RETURN.

**■ For video or audio files**

Press  $\uparrow/\downarrow$  to select a file.

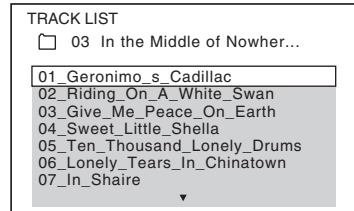
**■ For JPEG files**

Press  $\leftarrow/\uparrow/\downarrow/\rightarrow$  to select an image.

1	2	3	4
5	6	7	8
9	10	11	12
13	14	15	16

**4 Start playback.****■ For video or audio files**

Press  $\blacktriangleright$  to start playback from the selected file.

**■ For JPEG image files**

Press  $\blacktriangleright$  to start a slide show beginning with the selected file. Press  $\oplus$  to display only the selected file.

## To turn on/off the list of folders/files

Press DVD MENU.

## To display the list of folders/files using the Control Menu

- 1 Press DISPLAY.
- 2 Press  $\uparrow/\downarrow$  to select [BROWSING], then press  $\oplus$ .
- 3 Press  $\uparrow/\downarrow$  to select the desired list, then press  $\oplus$ .
  - [FOLDER LIST]: A list of folders appears. To display a list of files, press  $\uparrow/\downarrow$  to select a folder, then press  $\oplus$ .
  - [PICTURE LIST] (JPEG image files only): A thumbnail list of the JPEG image files in the folder appears.

## When different file types are on a disc/USB device

**DATA CD** **DATA DVD** **USB**

You can select the file type that is played with priority when mixed media (audio files, JPEG image files, or video files) are on the disc/USB device.

- 1 Press DISPLAY.
- 2 Press  $\uparrow/\downarrow$  to select [MEDIA], then press  $\oplus$ .
- 3 Press  $\uparrow/\downarrow$  to select a setting, then press  $\oplus$ .
  - [MUSIC/PHOTO] (DATA CD/DATA DVD only): You can play both JPEG image files and MP3 files in the same folder as a slide show.
  - [MUSIC]: Audio file playback has priority.
  - [VIDEO]: Video file playback has priority.
  - [PHOTO]: JPEG image file playback has priority. You can play JPEG image files as a slide show.

The default setting differs depending on the source.

For details of the playback priority of file types under the [MEDIA] setting, see “Playback Priority of File Types” (page 79).

## Other Playback Operations

### Playback operation buttons on the remote

**DVD-V** **DVD-VR** **VIDEO CD** **Super Audio CD** **CD**  
**DATA CD** **DATA DVD** **USB**

Depending on the type of disc/file, the function may not work.

To	Press
Stop	
Pause	
Return to normal playback or resume playback after pause	
Cancel the resume point	twice.
Skip the current chapter, track, file, or scene	or • : go to the beginning. • Press  twice in a second to go to the previous item. • : go to the next item.
Skip the current JPEG image file	or  during playback. • : go to the previous file. • : go to the next item.
Locate a point quickly	/ or / while playing a disc. • /: fast reverse scan. • /: fast forward scan. Each time you press / or / during scan, the scan speed changes.

To	Press
Watch frame by frame	<p><b>II</b>, then press <b>&lt;II/II&gt;</b> or <b>II/&gt;</b>.</p> <ul style="list-style-type: none"> <li><b>&lt;II/II&gt;</b>: slow-motion play (reverse).</li> <li><b>II/&gt;</b>: slow-motion play (forward).</li> </ul> <p>Each time you press <b>&lt;II/II&gt;</b> or <b>II/&gt;</b> during slow-motion play, the playback speed changes.</p>
Rotate a JPEG image file	<p><b>↑/↓</b> while viewing a JPEG image file.</p> <p>Press <b>CLEAR</b> while holding down <b>SHIFT</b> to return to normal view.</p>

#### Tip

- When playing files, you can select the next folder by continuing to press **II/>** (→ for JPEG image files) after the last file on the current folder, but you cannot return to the previous folder by pressing **<II/II>** (← for JPEG image files). To return to the previous folder, select the folder from the folder list.
- You cannot rotate the JPEG image file when you set [JPEG RESOLUTION] in [HDMI SETUP] to [(1920 × 1080i) HD □] or [(1920 × 1080i) HD] (page 63).

## Playing a specific title/ chapter/track/scene, etc.

### To select the title/chapter/track/ scene/index/folder/file number for playback



- Press **DISPLAY**.
- Press **↑/↓** to select the search method, then press **+**.
  - [TITLE/SCENE/TRACK]
  - [CHAPTER/INDEX]
  - [TRACK]
  - [INDEX]
  - [FOLDER]
  - [FILE]

Example: [CHAPTER]  
[\*\* (\*\*)] is selected (\*\* refers to a number).  
The number in parentheses indicates the total number of titles, chapters, tracks, indexes, scenes, folders, or files.

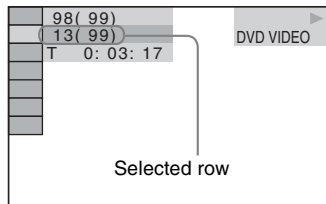

#### Note

- If [MEDIA] is set to [MUSIC/PHOTO] and [FILE] does not appear, press **DISPLAY** again.

### 3 Press **↑/↓** to select the desired number of the title, chapter, track, scene, etc., then press **+**.

You can also select the number by pressing the number buttons while holding down **SHIFT**.

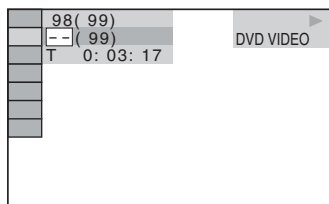

If you make a mistake, press **CLEAR** while holding down **SHIFT** to cancel the number.

### To select a scene using the time code



- Press **DISPLAY**.
- Press **↑/↓** to select [TIME], then press **+**.
- Input the time code using the number buttons while holding down **SHIFT**, then press **+**.

For example, to find a scene at 2 hours, 10 minutes, and 20 seconds after the beginning: press 2, 1, 0, 2, 0 ([2:10:20]) while holding down **SHIFT**.

**Note**

- You cannot search for a scene on a DVD+RW using the time code.

## Changing angles

**DVD-V**

Press **ANGLE** during playback to select the desired angle.

## Displaying subtitles

**DVD-V** **DVD-VR** **DATA CD** \* **DATA DVD** \* **USB** \*

- \* Except for United Kingdom and North American models.

Press **SUBTITLE** during playback to select the desired subtitle language.

**Note**

- You can select the subtitles if the DivX video file has an “.avi” or “.divx” extension and contains subtitle information within the same file (except for United Kingdom and North American models).

## Changing the audio

**DVD-V** **DVD-VR** **VIDEO CD** **C D** **DATA CD****DATA DVD** **USB**

Press **AUDIO** repeatedly during playback to select the sound.

**DVD VIDEO**

You can toggle audio format or language when the source contains multiple audio formats or multilingual audio.

When 4 digits are displayed, they indicate a language code. See “Language Code List” (page 80) to confirm which language the code represents.

When the same language is displayed two or more times, the DVD VIDEO is recorded in multiple audio formats.

## Example:

Dolby Digital 5.1 channel

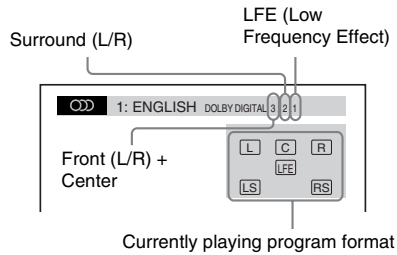
**DVD-VR**

You can toggle audio tracks when a disc contains multiple audio tracks.

**VIDEO CD/CD/DATA CD (MP3 file)/DATA DVD (MP3 file)/USB device (audio file)**

You can change the sound track.

- **[STEREO]**: The stereo sound.
- **[1/L]**: The sound of the left channel (monaural).
- **[2/R]**: The sound of the right channel (monaural).

**DATA CD (DivX video file)/DATA DVD (DivX video file)/USB device (DivX video file) (except for United Kingdom models)**

You can toggle audio tracks when a video file contains multiple audio tracks.

**Super VCD**

You can change the sound track.

- **[1:STEREO]**: The stereo sound of audio track 1.
- **[1:1/L]**: The sound of the left channel of audio track 1 (monaural).
- **[1:2/R]**: The sound of the right channel of audio track 1 (monaural).
- **[2:STEREO]**: The stereo sound of audio track 2.
- **[2:1/L]**: The sound of the left channel of audio track 2 (monaural).
- **[2:2/R]**: The sound of the right channel of audio track 2 (monaural).

## Using the DVD's menu

### DVD-V

When you play a DVD which contains several titles, you can select the title you want using DVD TOP MENU.

When you play a DVD that allows you to select items such as the language for the subtitles and the language for the sound, select these items using DVD MENU.

- 1 Press **DVD TOP MENU** or **DVD MENU**.
- 2 Press **←/↑/↓/→** to select the item you want to play or change, then press **⊕**.

You can also select the number by pressing the number buttons while holding down SHIFT.

### To display the DVD's menu on the Control Menu

- 1 Press **DISPLAY**.
- 2 Press **↑/↓** to select **[DISC MENU]**, then press **⊕**.
- 3 Press **↑/↓** to select **[MENU]** or **[TOP MENU]**, then press **⊕**.

## Selecting an original title or edited title on a DVD-VR

### DVD-VR

This function is only available for DVD-VRs with a playlist created.

- 1 Press **DISPLAY** while the system is in stop mode.
- 2 Press **↑/↓** to select **[ORIGINAL/PLAY LIST]**, then press **⊕**.
- 3 Press **↑/↓** to select a setting, then press **⊕**.
  - **[PLAY LIST]**: You can play the titles in the order of the existing playlist.
  - **[ORIGINAL]**: You can play the titles as they were originally recorded.

## Selecting a playback area for a Super Audio CD

### Super Audio CD

Some Super Audio CDs consist of a 2 channel playback area and a multi-channel playback area. You can select the playback area you want to listen to.

- 1 Press **DISPLAY** while the system is in stop mode.
- 2 Press **↑/↓** to select **[MULTI/2CH]**, then press **⊕**.
- 3 Press **↑/↓** to select the setting, then press **⊕**.
  - **[MULTI]**: You can play the multi-channel playback area.
  - **[2CH]**: You can play the 2 channel playback area.

## Changing a playback layer for a hybrid Super Audio CD

### Super Audio CD

Some Super Audio CDs consist of a Super Audio CD layer and a CD layer. You can change the playback layer you want to listen to.

- 1 Press **DISPLAY** while the system is in stop mode.
- 2 Press **↑/↓** to select **[SUPER AUDIO CD/CD LAYER]**, then press **⊕**.
  - When the current layer is the CD layer  
[SUPER AUDIO CD] appears.
  - When the current layer is the Super Audio CD layer  
[CD] appears.
- 3 Press **⊕** to change the layer.
  - **[SUPER AUDIO CD]**: You can play the Super Audio CD layer.  
When the system is playing a Super Audio CD layer, "SA-CD" lights up in the front panel display.

- [CD]: You can play the CD layer.  
When the system is playing a CD layer, “CD” lights up in the front panel display.

**Note**

- Super Audio CD audio signals are not output from the HDMI OUT jack.

## Selecting the Playback Mode

### Playing in programmed order

*(Program Play)*

VIDEO CD    C D

You can play the contents of a disc in the order you want by arranging the order of the tracks on the disc to create your own program. You can program up to 99 tracks.

- 1 Press **DISPLAY**.
- 2 Press **↑/↓** to select **[PROGRAM]**, then press **+**.
- 3 Press **↑/↓** to select **[SET →]**, then press **+**.

Total time of the programmed tracks

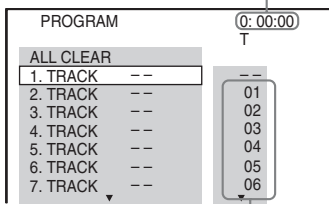

Tracks recorded on a disc

#### 4 Press **→**.

The cursor moves to the track row [T] (in this case, [01]).

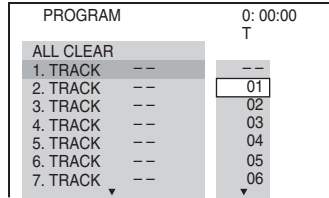

#### 5 Select the track you want to program.

**Ex. To set track 2 as the first programmed track**

Press **↑/↓** to select [02] under [T], then press **+**.

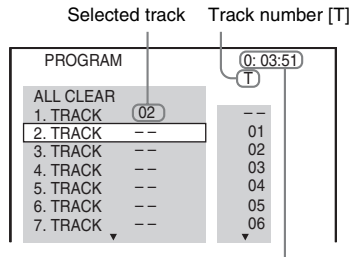

Total time of the programmed tracks

#### 6 To program other tracks, repeat Steps 4 to 5.

#### 7 Press **▶** to start Program Play.

#### To return to normal playback

Press CLEAR while holding down SHIFT when the display for the program setting is not displayed on the TV screen, or select [OFF] in Step 3. To play the same program again, select [ON] in Step 3 and press **+**.

#### To change or cancel a program

##### 1 Follow Steps 1 to 3 of “Playing in programmed order.”

##### 2 Press **↑/↓** to select the program number of the track you want to change or cancel.

If you want to delete the track from the program, press CLEAR while holding down SHIFT.

### 3 Follow Step 5 of “Playing in programmed order” for new programming.

To cancel a program, select [--] under [T], then press  $\oplus$ .

### To cancel all of the tracks in the programmed order

- 1 Follow Steps 1 to 3 of “Playing in programmed order.”
- 2 Press  $\uparrow$  and select [ALL CLEAR], then press  $\oplus$ .

## Playing in random order

### (Shuffle Play)

VIDEO CD Super Audio CD C D DATA CD DATA DVD

USB

#### Note

- The same song may be played repeatedly when you are playing MP3 files.

- 1 Press  $\text{DISP}$  DISPLAY during playback.
- 2 Press  $\uparrow/\downarrow$  to select  $\text{SHUFFLE}$  [SHUFFLE], then press  $\oplus$ .
- 3 Press  $\uparrow/\downarrow$  to select the item to be shuffled.

#### ■ VIDEO CD/Super Audio CD/CD

- [OFF]: Off.
- [TRACK]: You can shuffle tracks on the disc.

#### ■ During Program Play

- [OFF]: Off.
- [ON]: You can shuffle tracks selected in Program Play.

#### ■ DATA CD (audio files only)/DATA DVD (audio files only)/USB device (audio files only)

- [OFF]: Off.
- [ON (MUSIC)]: You can shuffle audio files in the folder on the current disc/USB device. When no folder is selected, the audio files in the first folder are shuffled.

- 4 Press  $\oplus$  to start Shuffle Play.

### To return to normal playback

Press CLEAR while holding down SHIFT, or select [OFF] in Step 3.

#### Note

- You cannot use Shuffle Play with a VIDEO CD or Super VCD with PBC playback.

## Playing repeatedly

### (Repeat Play)

DVD-V DVD-VR VIDEO CD Super Audio CD C D

DATA CD DATA DVD USB

- 1 Press  $\text{DISP}$  DISPLAY during playback.
- 2 Press  $\uparrow/\downarrow$  to select  $\text{REPEAT}$  [REPEAT], then press  $\oplus$ .
- 3 Press  $\uparrow/\downarrow$  to select the item to be repeated, then press  $\oplus$ .

#### ■ DVD VIDEO/DVD-VR

- [OFF]: Off.
- [DISC]: You can repeat all of the titles on the disc.
- [TITLE]: You can repeat the current title on a disc.
- [CHAPTER]: You can repeat the current chapter on a disc.

#### ■ VIDEO CD/Super Audio CD/CD

- [OFF]: Off.
- [DISC]: You can repeat all of the tracks on the disc.
- [TRACK]: You can repeat the current track.

#### ■ DATA CD/DATA DVD/USB device

- [OFF]: Off.
- [DISC] (DATA CD/DATA DVD only): You can repeat all of the folders on the disc.
- [MEMORY] (USB device only): You can repeat all of the folders on the USB device.
- [FOLDER]: You can repeat the current folder.
- [TRACK] (audio files only): You can repeat the current file.
- [FILE] (video files only): You can repeat the current file.



## 4 Press to start Repeat Play.

### To return to normal playback

Press CLEAR while holding down SHIFT, or select [OFF] in Step 3.



#### Note



- You cannot use Repeat Play with a VIDEO CD or Super VCD with PBC playback.

## Selecting an effect for the slide show

DATA CD DATA DVD USB

1 Press  DISPLAY repeatedly until  [EFFECT] appears on the control menu.

2 Press  to select  [EFFECT], then press .

3 Press  to select a setting, then press .



- [MODE 1]: The JPEG image file sweeps in from the top to the bottom of the TV screen.
- [MODE 2]: The JPEG image file stretches out from the left to the right of the TV screen.
- [MODE 3]: The JPEG image file stretches out from the center of the TV screen.
- [MODE 4]: The JPEG image files randomly cycle through the effects.
- [MODE 5]: The next JPEG image file slides over the previous image.
- [OFF]: Off.

#### Note



- The [EFFECT] setting is not effective when you set [JPEG RESOLUTION] in [HDMI SETUP] to [(1920 × 1080i) HD ] or [(1920 × 1080i) HD] (page 63).
- The [EFFECT] setting cannot be selected when you are playing a disc that does not contain JPEG image files or a USB device, or when you set [MEDIA] to a setting that cannot play JPEG image files.

## Selecting the slide show duration

DATA CD DATA DVD USB

1 Press  DISPLAY repeatedly until  [INTERVAL] appears on the control menu.

2 Press  to select  [INTERVAL], then press .

3 Press  to select a setting, then press .

- [NORMAL]: You can set to the standard duration.
- [FAST]: You can set the duration shorter than [NORMAL].
- [SLOW 1]: You can set the duration longer than [NORMAL].
- [SLOW 2]: You can set the duration longer than [SLOW 1].

#### Note

- Some JPEG image files may take longer to display than the option you selected, especially progressive JPEG image files or JPEG image files of 3,000,000 pixels or more.
- The [INTERVAL] setting cannot be selected when you are playing a disc that does not contain JPEG image files or a USB device, or when you set [MEDIA] to a setting that cannot play JPEG image files.



## Playing a slide show with sound

DATA CD DATA DVD

1 Prepare a folder on a disc which contains both MP3 files and JPEG image files.

The MP3 files and JPEG image files must not be in separate folders. For details of making the disc, refer to the instructions of your PC, software, etc.

2 Press  DISPLAY.

3 Press  to select  [MEDIA], then press .

**4** When [MUSIC/PHOTO] is selected, go to Step 5. When other than [MUSIC/PHOTO] is selected, press  $\uparrow/\downarrow$  to select [MUSIC/PHOTO], then press  $\oplus$ .

**5** If the folder list does not appear, press DVD MENU.

You can turn the folder list on/off by pressing DVD MENU repeatedly.

**6** Press  $\uparrow/\downarrow$  to select the desired folder and press  $\blacktriangleright$ .

**Note**

- If you play a large MP3 file and JPEG image file at the same time, the sound may skip. Sony recommends that you set the MP3 bit rate to 128 kbps or lower when creating the file. If the sound still skips, reduce the size of the JPEG image file.

## Displaying the Information of a Disc/USB Device

### Viewing playback information



Press TIME/TEXT repeatedly during playback.

### Information on the TV screen

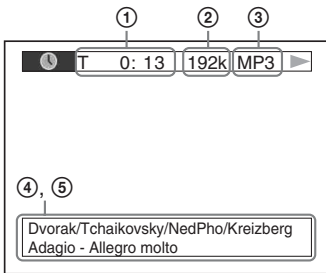

① [T \*\*:\*\*:\*\*/C \*\*:\*\*:\*\*/D \*\*:\*\*:\*\*]

Playing time of the current title, track/  
chapter/disc

[T \*\*:\*\*:\*\*/C- \*\*:\*\*:\*\*/D- \*\*:\*\*:\*\*]

Remaining time of the current title, track/  
chapter/disc

[\*\*:\*\*]\*\*

Playing time of the current scene/video file

② **Bit rate**

Appears when playing an audio file.

③ **File type**

Appears when playing an audio/video file.

④ **Folder/file name**

Appears when playing an audio file/JPEG  
image file/video file.

If an MP3 file has an ID3 tag, the system  
will display an album name/title name from  
the ID3 tag information.

The system can support ID3 ver 1.0/1.1/2.2/  
2.3.

ID3 ver 2.2/2.3 tag information display has  
priority when both ID3 ver 1.0/1.1 and ver  
2.2/2.3 tags are used for a single MP3 file.

⑤ **Text information**

The DVD/Super Audio CD/CD text  
appears only when text is recorded on the  
disc. You cannot change the text. If the disc  
does not contain text, "NO TEXT" appears.

**Note**

- Depending on the source being played, the system can only display a limited number of characters. Also, depending on the source, not all text characters will be displayed.

### Information in the front panel display

Each time you press TIME/TEXT during  
playback, the following information appears.  
Some displayed items may disappear after a few  
seconds.

■ **DVD VIDEO/DVD-VR**

- ① Playing time of the current title
- ② Remaining time of the current title
- ③ Playing time of the current chapter
- ④ Remaining time of the current chapter
- ⑤ Disc name

⑥ Title and chapter

### ■ VIDEO CD (with PBC functions)/Super VCD (with PBC functions)

- ① Playing time of the current item
- ② Disc name
- ③ Scene number

### ■ VIDEO CD (without PBC functions)/Super Audio CD/CD

- ① Playing time of the current track
- ② Remaining time of the current track
- ③ Playing time of the disc
- ④ Remaining time of the disc
- ⑤ Track name
- ⑥ Track and index\*

\* VIDEO CD/Super Audio CD only.

### ■ Super VCD (without PBC functions)

- ① Playing time of the current track
- ② Track text
- ③ Track and index number

### ■ DATA CD/DATA DVD/USB device (audio file)

- ① Playing time and current track number
- ② Track (file) name\*

\* If an MP3 file has an ID3 tag, the system will display a title name from the ID3 tag information. The system can support ID3 ver 1.0/1.1/2.2/2.3. ID3 ver 2.2/2.3 tag information display has priority when both ID3 ver 1.0/1.1 and ver 2.2/2.3 tags are used for a single MP3 file.

### ■ DATA CD (video file)/DATA DVD (video file)/USB device (video file)

- ① Playing time of the current file
- ② Current file name
- ③ Current album and file number



#### Note

- The system can only display the first level of the DVD/CD text, such as the disc name or title.
- The disc name or track name may not be displayed depending on the text.
- Playing time of MP3 files and video files may not be displayed correctly.

## Viewing the date information of a JPEG image file

DATA CD DATA DVD USB

You can check the date information during playback when the Exif\* tag is recorded in the JPEG image file.

Press  **DISPLAY** repeatedly until  **[DATE]** appears on the control menu.

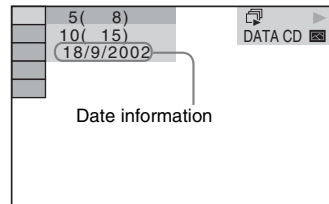

\* "Exchangeable Image File Format" is a digital camera image format defined by the Japan Electronics and Information Technology Industries Association (JEITA).

## Enjoying the Audio/Video of the Connected Component

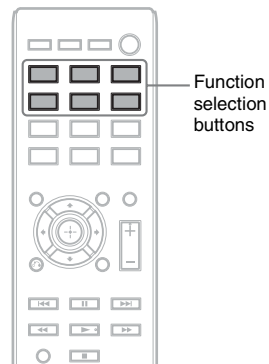

# 1 Use the function selection buttons to select the desired function.

The selected item appears in the front panel display.

Button	Source
DVD/CD	Disc that is played by the system
FM	FM radio
USB	USB device or iPod* that is connected to the  (USB) port.
TV	TV or cable box/set-top box
AUDIO IN	Portable audio source that is connected to the AUDIO IN jack on the front panel

You can also select the desired function by pressing FUNCTION repeatedly.

# 2 Prepare the source.

- DVD/CD: Insert the disc into the unit (page 33).
- TUNER FM: Select the radio program (page 46).
- USB: Connect the USB device directly (page 33), or iPod\* via a USB cable (page 44).
- TV: Select the channel on the TV or set-top box.
- AUDIO IN: Connect the portable audio source via an audio cord (stereo mini-plug cord) (page 28).

# 3 Operate the connected component.

To enjoy a set-top box, select the input of the set-top box via the TV to which it is connected.

\* United Kingdom models only.

## iPod models that can be operated via USB







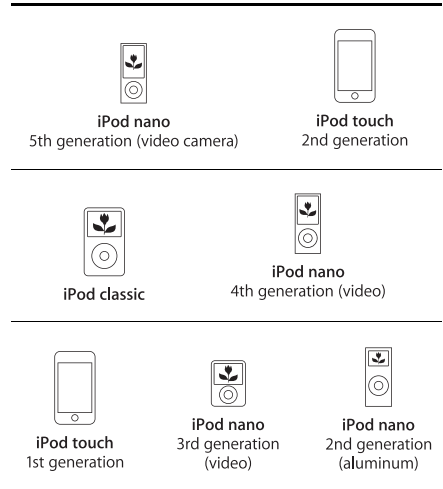



You can operate an iPod using the buttons on the remote by connecting the iPod via the  (USB) port to the system.

The battery of the iPod is charged via the system.

The iPod models that can be operated via USB are as follows. Update your iPod with the latest software before using it with the system.



Remote buttons for operating an iPod connected to the system are as follows:

Press	Operation
	Same operation as the  button of the iPod.
	Pause.
	Fast reverse or forward.
	Same operation as the  buttons of the iPod.
 DISPLAY,  RETURN,	Same operation as the MENU button of the iPod.
	
	Same operation as the Click Wheel of the iPod.
	Same operation as the Center button of the iPod.

### Note

- The iPod is charged when connected to the system while the system is turned on.
- You cannot transfer songs onto the iPod.
- Sony cannot accept responsibility in the event that data recorded to iPod is lost or damaged when using an iPod connected to this unit.

- This product has been designed specifically to work with iPod and has been certified to meet Apple performance standards.

## Presetting Radio Stations

You can preset 20 FM stations.

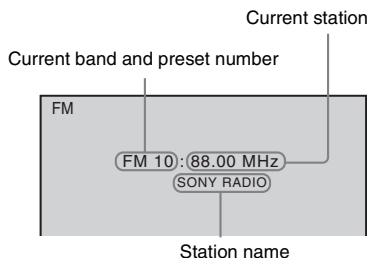

- 1 Press FM.**
- 2 Press and hold TUNING +/- until the auto scanning starts.**  
Scanning stops when the system tunes in a station. "TUNED" appears in the front panel display. When a stereo program is received, "ST" also appears in the front panel display.

- 3 Press SYSTEM MENU.**
- 4 Press ↑/↓ to select "MEMORY."**
- 5 Press ⊕ or →.**  
A preset number appears in the front panel display.

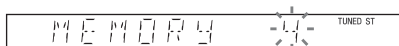

- 6 Press ↑/↓ to select the preset number you want.**

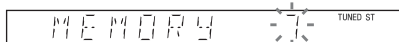

- 7 Press ⊕.**  
"COMPLETE" appears in the front panel display, and the station is stored.

- 8 Repeat Steps 2 to 7 to store other stations.**
- 9 Press SYSTEM MENU.**

### To change the preset number

Select the desired preset number by pressing PRESET +/- (page 46), then perform the procedure from Step 3.

## Listening to the Radio

Preset radio stations in the system's memory first (see "Presetting Radio Stations" (page 46)).

- 1 Press FM.**
- 2 Press PRESET +/- repeatedly to select the preset station.**
- 3 Adjust the volume by pressing VOLUME +/-.**

### To listen to radio stations when you know the frequencies

Press D.TUNING in Step 2, press the number buttons while holding down SHIFT to select the frequencies, then press ⊕.

### To listen to non-preset radio stations

Use manual or automatic tuning in Step 2. For manual tuning, press TUNING +/- repeatedly.

For automatic tuning, press and hold TUNING +/- . The automatic tuning stops automatically when the system receives the radio station. To stop the automatic tuning manually, press TUNING +/- or ■.

### If an FM program is noisy

If an FM program is noisy, you can select monaural reception. There will be no stereo effect, but reception will improve.

- 1 Press SYSTEM MENU.**
- 2 Press ↑/↓ to select "FM MODE."**

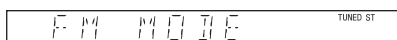

- 3 Press ⊕ or →.**
- 4 Press ↑/↓ to select "MONO."**
  - "STEREO": Stereo reception.
  - "MONO": Monaural reception.

**5** Press  $\oplus$ .

**6** Press SYSTEM MENU.

## Viewing the station name or frequency in the front panel display

You can check the station name or frequency using the front panel display.

**Press TIME/TEXT.**

Each time you press TIME/TEXT, the display changes as follows.

**When the station name is received via the RDS function**

- ① Station name  
Ex. "SONY RADIO"
- ② Frequency  
Ex. "FM1 87.50"
- ③ The "FM MODE" setting  
Ex. "STEREO"

**When the station name is not set**

- ① Frequency  
Ex. "FM1 87.50"
- ② The "FM MODE" setting  
Ex. "STEREO"

---

## Using the Radio Data System (RDS)

### What is the Radio Data System?

The Radio Data System (RDS) is a broadcasting service that allows radio stations to send additional information along with the regular program signal. This tuner offers convenient RDS features, such as station name display.

## Receiving RDS broadcasts

**Simply select a station.**

When you tune in a station that provides RDS services, the station name\* appears in the front panel display.

\* If an RDS broadcast is not received, the station name does not appear in the front panel display.

**Note**

- Not all FM stations provide RDS service, nor do they provide the same type of services. If you are not familiar with RDS services, check with your local radio stations for details and availability in your area.

## Enjoying Surround Sound

You can enjoy surround sound simply by selecting one of the system's pre-programmed surround settings.

### Enjoying TV sound with the 5.1 channel surround sound effect

- 1** Press **SYSTEM MENU**.
- 2** Press **↑/↓** to select "SUR.SETTING," then press **⊕** or **→**.  
The selected item appears in the front panel display.
- 3** Press **↑/↓** to select "PRO LOGIC," then press **⊕**.
- 4** Press **SYSTEM MENU**.

**Note**

- When TV program sound is monaural, sound is output only from the center speaker.

### Selecting surround settings based on your listening preference

- 1** Press **SYSTEM MENU**.
- 2** Press **↑/↓** to select "SUR.SETTING," then press **⊕** or **→**.  
The selected item appears in the front panel display.
- 3** Press **↑/↓** to select the surround setting you want, then press **⊕**.  
See the table below for surround setting descriptions.
- 4** Press **SYSTEM MENU**.

#### About speaker output

The table below describes the options when you connect all the speakers to the unit and you set [SPEAKER FORMATION] to [STANDARD] (page 65).

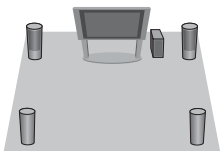
Sound from	Surround setting	Effect
	"A.F.D. MULTI" (AUTO FORMAT DIRECT MULTI)	<ul style="list-style-type: none"> <li>• 2 channel source: The system outputs 2 channel sound from the front and surround speakers by assigning the 2 channel sound to the surround left and right channels.</li> <li>• Multi-channel source: The system outputs sound from the speakers depending on the number of channels of the source.</li> </ul>

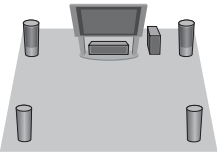
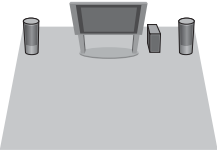

Sound from	Surround setting	Effect
	"PRO LOGIC" "PLII MOVIE" "PLII MUSIC"	<ul style="list-style-type: none"> <li>• 2 channel source: The system simulates surround sound from 2 channel sources and outputs sound from all the speakers.               <ul style="list-style-type: none"> <li>– "PRO LOGIC" performs Dolby Pro Logic decoding.</li> <li>– "PLII MOVIE" performs Dolby Pro Logic II movie mode decoding.</li> <li>– "PLII MUSIC" performs Dolby Pro Logic II music mode decoding.</li> </ul> </li> <li>• Multi-channel source: The system outputs sound from the speakers depending on the number of channels of the source.</li> </ul>
	"2CH STEREO"	The system outputs the sound from the front speakers and subwoofer regardless of sound format or number of channels. Multi-channel surround formats are downmixed to 2 channels.
Depending on the source.	"A.F.D. STD" (AUTO FORMAT DIRECT STANDARD)	The system discriminates the sound format of the source and presents sound as it was recorded/encoded.

**Note**

- You cannot select the surround settings while the system is loading a disc.
- Depending on the input stream, the surround settings may not be effective.

# Selecting the Sound Effect

## Selecting the effect to suit the source

Press **SOUND MODE** repeatedly during playback until the desired mode appears in the front panel display.

- **“AUTO”**: The system automatically selects “MOVIE” or “MUSIC” to produce the sound effect depending on the source. “AUTO” appears in the front panel display.
- **“MOVIE”**: The system provides the sound for movies. “MOVIE” appears in the front panel display.
- **“MUSIC”**: The system provides the sound for music. “MUSIC” appears in the front panel display.

### Note

- When you play a Super Audio CD, this function does not work.

## Enhancing compressed sound

You can enhance compressed sound such as an MP3 file.

This effect is activated automatically when all the following conditions are satisfied:

- The function is set to “AUDIO IN” or “USB.”
- “SUR.SETTING” is set to “A.F.D. STD” or “A.F.D. MULT” (page 48).

### To turn off the sound effect

Select other than “A.F.D. STD” or “A.F.D. MULT” for “SUR.SETTING” (page 48).

## Using the Control for HDMI Function for “BRAVIA” Sync

This function is available on TVs with the “BRAVIA” Sync function.

By connecting Sony components that are compatible with the Control for HDMI function with an HDMI cable, operation is simplified as below:

- System Power Off (page 51)
- One-Touch Play (page 52)
- Theatre Mode (page 52)
- System Audio Control (page 52)
- Volume Limit (page 52)
- Audio Return Channel (page 52)
- Remote Easy Control (page 52)
- Language Follow (page 53)

Control for HDMI is a mutual control function standard used by CEC (Consumer Electronics Control) for HDMI (High-Definition Multimedia Interface).

**Note**

- Depending on the connected component, the Control for HDMI function may not work. Refer to the operating instructions of the component.

### Preparing the Control for HDMI function

#### *(Control for HDMI - Easy Setting)*

If your TV is compatible with the Control for HDMI - Easy Setting function, you can set the system’s [CONTROL FOR HDMI] function automatically by setting your TV. For details, refer to the operating instructions of your TV.

If your TV is not compatible with the Control for HDMI - Easy Setting function, set the Control for HDMI function of the system and TV manually.

- 1** Make sure that the system and your TV are connected with an HDMI cable.
- 2** Turn on your TV and press **I/⏻** to turn on the system.
- 3** Switch the input selector on your TV so that the signal from the system through the HDMI input appears on the TV screen.
- 4** Set the Control for HDMI function of your TV.  
For details of the setting of your TV, refer to the operating instructions of your TV.
- 5** On the system, press **DVD/CD**.
- 6** Press **⏻** **DISPLAY** while the system is in stop mode.
- 7** Press **↑/↓** to select **📺** **[SETUP]**, then press **+**.
- 8** Press **↑/↓** to select **[CUSTOM]**, then press **+**.
- 9** Press **↑/↓** to select **[HDMI SETUP]**, then press **+**.
- 10** Press **↑/↓** to select **[CONTROL FOR HDMI]**, then press **+**.
- 11** Press **↑/↓** to select **[ON]**, then press **+**.

### Turning the system off in sync with your TV

#### *(System Power Off)*

When you turn your TV off by using the POWER button on your TV’s remote or TV **I/⏻** on the system’s remote, the system turns off automatically.

**Note**

- This function depends on the settings of your TV. For details, refer to the operating instructions of your TV.
- Depending on the status of the system (ex. while playing a CD), the system may not turn off automatically.

## Watching a DVD by a single button press

### *(One-Touch Play)*

#### Press ONE-TOUCH PLAY

Your TV turns on, your TV's function is set to the HDMI input to which the system is connected, and the system starts playing a disc automatically.

The System Audio Control function is also activated automatically.

## Using the Theatre Mode

### *(Theatre Mode)*

If your TV is compatible with the Theatre Mode, you can enjoy optimal image and sound quality suited for movies, and the System Audio Control function is activated automatically.

Press THEATRE.

## Enjoying TV sound from the speakers by this system

### *(System Audio Control)*

To use this function, connect the system and your TV with a SCART (EURO AV) cable and an HDMI cable (page 26).

Press **I/⏻** to turn on the system while your TV is turned on.

The System Audio Control function is activated. TV sound is output from the system speakers, and the volume of your TV's speakers is minimized automatically.

#### **Note**

- While your TV is in PAP (picture and picture) mode, the System Audio Control function will not work. When your TV exits PAP mode, the output method of your TV returns to the one before PAP mode.
- When you turn the system on by pressing the function selection button, video and sound may not match.
- Depending on the TV, when you adjust the system's volume, the volume level appears on the TV screen. In this case, the volume levels that appear on the TV

screen and the front panel display of the system may differ.

#### **Tip**

- You can also operate the System Audio Control function via the TV menu.
- You can operate the volume and mute control of the system via the TV remote.

## Limiting the volume level of TV sound from the system's speakers

### *(Volume Limit)*

When the System Audio Control function is activated and TV sound is output from the system's speakers, the volume level is limited to the level that is set in [VOLUME LIMIT]. For details, see [VOLUME LIMIT] (page 64).

## Receiving the digital audio signal of your TV

### *(Audio Return Channel)*

The system can receive the digital audio signal of your TV via an HDMI cable when your TV is compatible with the Audio Return Channel function. You can enjoy TV sound via the system by using just one HDMI cable. For details, see [AUDIO RETURN CHANNEL] (page 64).

## Operating the system via the TV remote

### *(Remote Easy Control)*

You can control the basic functions of the system via the TV remote when the system's video output is displayed on the TV screen. For details, refer to the operating instructions of the TV.

## Changing the language for the system's on-screen display in sync with your TV

### (Language Follow)

When you change the language for the on-screen display of your TV, the system's on-screen display language is also changed.

#### Note

- When the system's on-screen display is displayed, this function does not work.

## Using an S-AIR Product

### (DAV-DZ730 only)

When you purchase the S-AIR product, you need to perform the following settings to activate wireless transmission.

### About S-AIR products

There are two types of S-AIR products.

- S-AIR main unit (this unit): This is for transmitting sound. You can use up to three S-AIR main units. (The number of usable S-AIR main units depends on the use environment.)
- S-AIR sub unit: This is for receiving sound.
  - **Surround amplifier (optional):** You can enjoy surround speaker sound wirelessly.
  - **S-AIR receiver (optional):** You can enjoy system sound in another room.

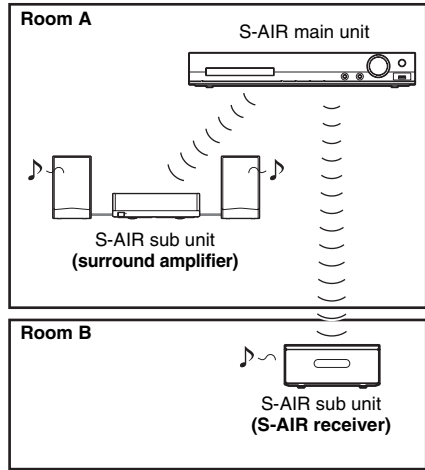

## Inserting the wireless transmitter/transceiver

To make use of the S-AIR function, you need to insert the wireless transmitter into the unit and the wireless transceiver into the S-AIR sub unit.

#### Note

- When you insert the wireless transmitter/transceiver, make sure that the AC power cord (mains lead) is not connected to a wall outlet (mains).
- Do not touch the terminals of the wireless transmitter/transceiver.

### To insert the wireless transmitter into the unit

- 1 Remove the screws directly below the  mark.

Rear of the unit

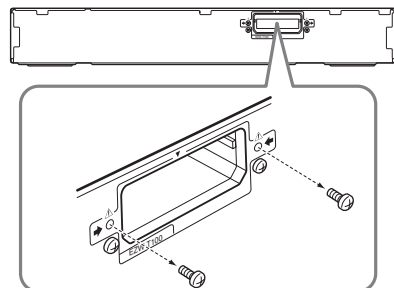

**Note**

- Remove the screws that are indicated in the illustration. Do not remove other screws.

## 2 Insert the wireless transmitter.

Rear of the unit

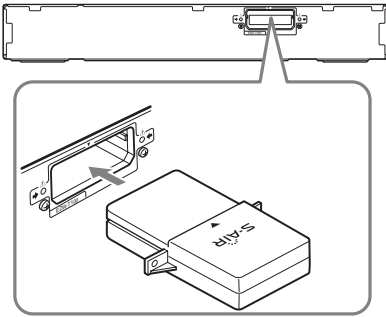
**Note**

- Insert the wireless transmitter with the S-AIR logo facing up.
- Insert the wireless transmitter so that the ▼ marks are aligned.
- Do not insert anything other than the wireless transmitter into the EZW-T100 slot.

## 3 Make sure to use the same screws to secure the wireless transmitter.

Rear of the unit

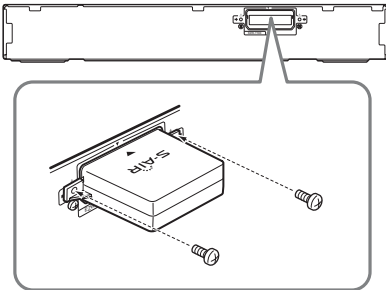

## To insert the wireless transceiver into the S-AIR sub unit

For details on installing the wireless transceiver into the S-AIR sub unit, such as a surround amplifier or S-AIR receiver, see the operating instructions of the S-AIR sub unit.

**Tip**

- When you change the S-AIR configuration, Sony recommends that you perform [AUTO CALIBRATION] (page 65).

## Setting the S-AIR ID to activate wireless transmission

*For the surround amplifier*

*For the S-AIR receiver*

Simply by matching the ID of the main unit and the S-AIR sub unit, you can activate wireless transmission.

### To set the ID of the unit

- Press **SYSTEM MENU**.
- Press **↑/↓** to select "S-AIR ID," then press **+** or **→**.  
The selected item appears in the front panel display.
- Press **↑/↓** to select the desired ID, then press **+**.  
You can select any ID (A, B, or C).
- Press **SYSTEM MENU**.
- Set the S-AIR sub unit to the same ID.  
Wireless transmission is activated as follows (example):

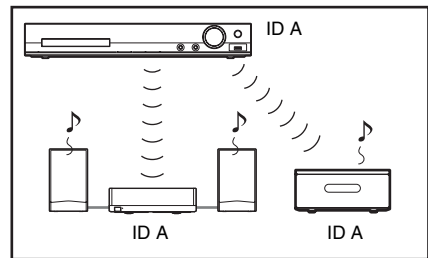
**Tip**

- To confirm the current ID, perform Steps 1 to 3 above. When you pair the unit with an S-AIR sub unit (page 55), "PAIRING" appears beside ID in the front panel display.

## To set the ID of the surround amplifier

Refer to the operating instructions of the surround amplifier.

## To set the ID of the S-AIR receiver

Refer to the operating instructions of the S-AIR receiver.

## Enjoying the system's sound in another room

### For the S-AIR receiver

You can enjoy the system's sound in another room by using the S-AIR receiver.

- 1 Press SYSTEM MENU.**
- 2 Press  $\uparrow/\downarrow$  to select "S-AIR MODE," then press  $\oplus$  or  $\rightarrow$ .**

The selected item appears in the front panel display.
- 3 Press  $\uparrow/\downarrow$  to select the desired setting, then press  $\oplus$ .**
  - **"PARTY"**: You can set the S-AIR receiver to output the same sound as the main unit.
  - **"SEPARATE"**: You can set the S-AIR receiver to output the sound selected via the S-AIR receiver itself.
- 4 Press SYSTEM MENU.**
- 5 When you select "SEPARATE" in Step 3, press S-AIR CH on the S-AIR receiver to select the function.**

The S-AIR receiver's function changes as follows.

"MAIN UNIT"  $\rightarrow$  "TUNER FM"  $\rightarrow$   
"AUDIO IN"  $\rightarrow$  ...

To enjoy the same function as the main unit, select "MAIN UNIT."
- 6 Adjust the volume on the S-AIR receiver.**

## Enjoying sound by the S-AIR receiver while the main unit is in standby mode

### For the S-AIR receiver

You can receive the system's sound by the S-AIR receiver while the main unit is in standby mode by setting "S-AIR STBY" to "STBY ON."

- 1 Press SYSTEM MENU.**
- 2 Press  $\uparrow/\downarrow$  to select "S-AIR STBY," then press  $\oplus$  or  $\rightarrow$ .**

The selected item appears in the front panel display.
- 3 Press  $\uparrow/\downarrow$  to select the desired setting, then press  $\oplus$ .**
  - **"STBY ON"**: You can receive the system's sound by the S-AIR receiver while the unit is in standby mode or turned on.
  - **"STBY OFF"**: You cannot receive the system's sound by the S-AIR receiver while the unit is in standby mode.
- 4 Press SYSTEM MENU.**

#### Note

- When you turn the system off while "S-AIR STBY" is set to "STBY ON," "S-AIR" flashes (when wireless transmission between the unit and S-AIR receiver is not activated), or lights up (when wireless transmission between the unit and S-AIR receiver is activated) in the front panel display.

## Identifying the unit with a specific S-AIR sub unit (Pairing operation)

### For the surround amplifier

### For the S-AIR receiver

When using S-AIR products, neighbors may also receive your system's sound if IDs are the same, or you may receive sound from neighbors. To prevent this, you can identify the unit with a specific S-AIR sub unit by performing the pairing operation.

When you perform pairing, wireless transmission is activated between the paired main unit and S-AIR sub unit only.

**1 Place the S-AIR sub unit that you want to pair near the unit.**

**2 Match the IDs of the unit and the S-AIR sub unit.**

- To set the ID of the unit, see “To set the ID of the unit” (page 54).
- To set the ID of the surround amplifier, refer to the operating instructions of the surround amplifier.
- To set the ID of the S-AIR receiver, refer to the operating instructions of the S-AIR receiver.

**3 Press SYSTEM MENU.**

**4 Press  $\uparrow/\downarrow$  to select “PAIRING,” then press  $\oplus$  or  $\rightarrow$ .**

The selected item appears in the front panel display.

**5 After “START” appears in the front panel display, press  $\oplus$ .**

The unit starts pairing and “SEARCH” flashes in the front panel display.

To cancel pairing, press SYSTEM MENU.

**6 Start pairing of the S-AIR sub unit.**

**■ For the surround amplifier**

Press  $\mathbb{I}/\text{ON}$  on the surround amplifier to turn on the surround amplifier and press PAIRING on the rear panel of the surround amplifier. (To press PAIRING, a slim instrument, such as a paper clip, can be used.)

The PAIRING indicator of the surround amplifier flashes when pairing starts.

When wireless transmission is activated, the PAIRING indicator of the surround amplifier turns on and “PAIRING” and “COMPLETE” appear alternately in the front panel display.

**■ For the S-AIR receiver**

Refer to the operating instructions of the S-AIR receiver.

When wireless transmission is activated, “PAIRING” and “COMPLETE” appear alternately in the front panel display.

**Note**

- Perform pairing within several minutes of Step 5. If you do not do so, “PAIRING” and “INCOMPLETE” appear alternately in the front panel display. To continue pairing, press  $\oplus$  and start again from Step 5. To cancel pairing, press SYSTEM MENU.

**7 Press SYSTEM MENU.**

**To cancel pairing**

Change the ID of the main and sub unit (page 54).

**If wireless transmission is unstable**

*For the surround amplifier*

*For the S-AIR receiver*

If you use multiple wireless systems, such as wireless LAN or Bluetooth, the transmission of S-AIR signals or other wireless signals may be unstable. In this case, the transmission may be improved by changing the following “RF CHANGE” setting.

**1 Press SYSTEM MENU.**

**2 Press  $\uparrow/\downarrow$  to select “RF CHANGE,” then press  $\oplus$  or  $\rightarrow$ .**

The selected item appears in the front panel display.

**3 Press  $\uparrow/\downarrow$  to select the desired setting, then press  $\oplus$ .**

- “AUTO”: Normally select this. The system changes “RF CHANGE” to “ON” or “OFF” automatically.
- “ON”: The system transmits sound by searching for the better channel for transmitting.
- “OFF”: The system transmits sound by fixing the channel for transmitting.

**4 Press SYSTEM MENU.**

**5 When you set “RF CHANGE” to “OFF,” select the ID so that wireless transmission is most stable (page 54).**



**Note**

- In most cases, you will not need to change this setting.
  - If “RF CHANGE” is set to “OFF,” transmission between the unit and S-AIR sub unit can be performed using one of the following channels.
  - S-AIR ID A: equivalent channel for IEEE 802.11b/g channel 1
  - S-AIR ID B: equivalent channel for IEEE 802.11b/g channel 6
  - S-AIR ID C: equivalent channel for IEEE 802.11b/g channel 11
- The transmission may be improved by changing the transmission channel (frequency) of the other wireless system(s). For details, refer to the operating instructions of the other wireless system(s).

## Transferring Songs onto a USB Device

You can transfer songs on an audio CD onto a USB device by encoding to MP3 format. You can also transfer MP3 files on a DATA CD/ DATA DVD onto a USB device.

For connecting the USB device, see “Playing Files on a Disc/USB Device” (page 33).

The transferred music is limited to private use only. Use of the music beyond this limit requires permission of the copyright holders.

### Notes on USB transferring

- Do not connect the unit and the USB device through a USB hub.
- Make sure there is enough space in the USB device for transferring.
- Do not remove the USB device during transferring.
- When you are transferring tracks from an audio CD, the tracks are recorded as 128 kbps MP3 files.
- When you are transferring MP3 files from a DATA CD/DATA DVD, the MP3 files are transferred with the same bit rate as the original MP3 files.
- CD text information is not transferred in the created MP3 files.

- If you stop a transfer from an audio CD halfway, the MP3 file that was being created is deleted.
- Transferring stops automatically if:
  - the USB device runs out of space during transfer.
  - the number of folders on the USB device reaches the limit for the number that the system can recognize.
- You can store up to 150 files in a folder.
- You can store up to 199 folders in a single USB device.
- If a folder or file that you are trying to transfer already exists on the USB device with the same name, a sequential number is added after the name without overwriting the original folder or file.

### To select the transfer destination of the USB device

You can select the memory number for transfer depending on the USB device.

**Press MEM SEL.**

Selected memory number

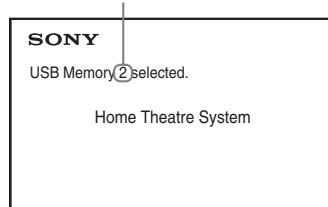
**Note**

- When the memory cannot be selected, [Operation not possible.] appears on the TV screen.
- The memory number changes depending on the USB device.
- Select a transfer destination before transfer.

### Folder and file generation rules

When transferring onto a USB device, a “MUSIC” folder is created directly below the “ROOT”. Folders and files are generated within this “MUSIC” folder as follows according to the transferring method and source.

- When transferring multiple tracks on an audio CD or multiple MP3 files on a DATA CD/ DATA DVD

Source	Folder name	File name
MP3	Same as the transferring source <sup>1)</sup>	
Audio CD	“FLDR001” <sup>2)</sup>	“TRACK001” <sup>3)</sup>

- When transferring a single track on an audio CD or a single MP3 file on a DATA CD/ DATA DVD

Source	Folder name	File name
MP3	“REC1-MP3” <sup>4)</sup>	Same as the transferring source <sup>1)</sup>
Audio CD	“REC1-CD” <sup>4)</sup>	“TRACK001” <sup>3)</sup>



<sup>1)</sup>Up to 64 characters of the name are assigned (including the extension).

<sup>2)</sup>Folders are assigned in numeric order thereafter.

<sup>3)</sup>Files are assigned in numeric order thereafter.

<sup>4)</sup>A new file is transferred in the “REC1-MP3” or “REC1-CD” folder each time single-track transferring is performed.

## Transferring tracks on an audio CD or MP3 files on a DATA CD/DATA DVD onto a USB device

- 1** Load an audio CD/DATA CD/DATA DVD.
- 2** Press  DISPLAY while the system is in stop mode.
- 3** Press  $\uparrow/\downarrow$  to select  [USB TRANSFER], then press  $\oplus$ .

### ■ For an audio CD

Press  $\oplus$  and skip to Step 5.

### ■ For a DATA CD/DATA DVD

Follow the next Step.

- 4** Press  $\uparrow/\downarrow$  to select [TRACK] or [FOLDER], then press  $\oplus$ .

- [TRACK]: The folder list appears. Press  $\uparrow/\downarrow$  to select the desired folder, then press  $\oplus$ .

- [FOLDER]: The folders recorded on the DATA CD/DATA DVD appear. You can transfer all MP3 files in the folder.

- 5** Press  $\leftarrow/\rightarrow$  to select  ALL (for an audio CD) or  ALL (for a DATA CD/ DATA DVD), then press  $\oplus$ .

To deselect all tracks, select  ALL, then press  $\oplus$ .

- 6** Press  $\leftarrow/\rightarrow$  to select [START], then press  $\oplus$ .

To cancel transferring, press  $\blacksquare$ .

## To select individual tracks/MP3 files/folders

Press  $\uparrow/\downarrow$  to highlight the track/MP3 file/folder, then press  $\oplus$  to add a check in Step 5.

To cancel the selection, highlight the track/MP3 file/folder, then press  $\oplus$  to remove the check.

### ■ For an audio CD

Remaining space of the USB device

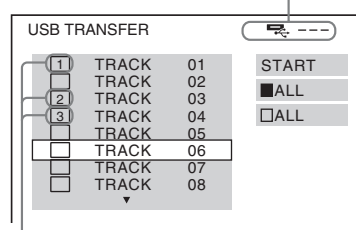

Tracks to be transferred.

### ■ For a DATA CD/DATA DVD

Remaining space of the USB device

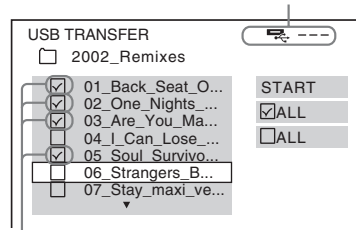

MP3 files/folders to be transferred.

## Transferring by single button press

You can transfer tracks/MP3 files simply onto a USB device by using REC TO USB.

- 1 Load an audio CD/DATA CD/DATA DVD.**
- 2 Press ■.**

To transfer all tracks, skip to Step 4.  
To transfer a single track, follow the next Step.
- 3 Select the desired track/MP3 file, then press ►.**
- 4 Press REC TO USB on the unit.**

REC TO USB lights up and “READING” appears in the front panel display. Then, “PUSH PLAY” and the remaining space of the USB device appear alternately in the front panel display.
- 5 Press ► to start transferring.**

When transferring is completed, “COMPLETE” appears in the front panel display and playback of the disc and USB device stops automatically.  
To cancel transferring, press ■.

## Erasing audio files on a USB device

You can erase audio files (“.mp3,” “.wma,” or “.m4a”) on the USB device.

- 1 Press USB.**
- 2 Press ↑/↓ to select a folder.**
- 3 Select the audio file(s).**
  - **To erase all audio files in a folder**  
Press CLEAR while holding down SHIFT.
  - **To erase an audio file**  
Press ⊕ and press ↑/↓ to select the desired audio file, then press CLEAR while holding down SHIFT.
- 4 Press ←/→ to select [YES], then press ⊕.**

To cancel, select [NO], then press ⊕.

### Note

- Do not remove the USB device while erasing.
- If the folder to be erased contains non-audio format files or sub folders, these are erased from the list on the TV screen, but are not erased from the USB device.

## Using the sleep timer

You can set the system to turn off at a preset time, so you can fall asleep listening to music.

- 1 Press SYSTEM MENU.**
- 2 Press ↑/↓ to select “SLEEP,” then press ⊕ or →.**

The selected item appears in the front panel display.
- 3 Press ↑/↓ to select a setting, then press ⊕.**

The minutes display (the remaining time) changes by 10 minutes.
- 4 Press SYSTEM MENU.**

## Adjusting the Delay Between the Picture and Sound

### [A/V SYNC]



When the sound does not match the pictures on the TV screen, you can adjust the delay between the picture and sound.

- 1 Press ◀ DISPLAY.**
- 2 Press ↑/↓ to select  [A/V SYNC], then press ⊕.**
- 3 Press ↑/↓ to select a setting, then press ⊕.**

- [OFF]: Off.
- [ON]: You can adjust the delay between the picture and sound.

**Note**

- Depending on the input stream, [A/V SYNC] may not be effective.

## Enjoying Multiplex Broadcast Sound

### *(DUAL MONO)*

You can enjoy multiplex broadcast sound when the system receives or plays a Dolby Digital multiplex broadcast signal.

**Note**

- To receive a Dolby Digital signal, you need to connect a TV or other component to the unit with a digital optical cord (page 26). If your TV is compatible with the Audio Return Channel function (page 52), you can receive a Dolby Digital signal via an HDMI cable.

**Press AUDIO repeatedly to select the audio signal.**

The selected item appears in the front panel display.

- “MAIN”: Sound of the main language will be output.
- “SUB”: Sound of the sub language will be output.
- “MAIN+SUB”: Mixed sound of both the main and sub languages will be output.

## Changing the Input Level of the Sound from Connected Components

The sound distortion of the connected component may be improved by reducing the input level.

**1** Press TV or AUDIO IN.

**2** Press SYSTEM MENU.

**3** Press  $\uparrow/\downarrow$  to select “ATTENUATE,” then press  $\oplus$  or  $\rightarrow$ .

**4** Press  $\uparrow/\downarrow$  to select a setting, then press  $\oplus$ .

- “ATT ON”: You can attenuate the input level.

- “ATT OFF”: Normal input level.

This setting is made separately for each function.

**5** Press SYSTEM MENU.

## Changing the Brightness of the Front Panel Display

- 1 Press **SYSTEM MENU**.
- 2 Press  $\uparrow/\downarrow$  to select "DIMMER," then press  $\oplus$  or  $\rightarrow$ .  
The selected item appears in the front panel display.
- 3 Press  $\uparrow/\downarrow$  to select the brightness of the front panel display, then press  $\oplus$ .
  - "DIMMER OFF": The front panel display is bright.
  - "DIMMER ON": The front panel display is dim.
- 4 Press **SYSTEM MENU**.

## Setting the Demonstration Mode to On/Off

You can turn on/off the demonstration in the front panel display while the system is in standby mode.

- 1 Press **SYSTEM MENU**.
- 2 Press  $\uparrow/\downarrow$  to select "DEMO," then press  $\oplus$  or  $\rightarrow$ .  
The selected item appears in the front panel display.
- 3 Press  $\uparrow/\downarrow$  to select a setting, then press  $\oplus$ .
  - "DEMO OFF": Off.
  - "DEMO ON": On.
- 4 Press **SYSTEM MENU**.

## Reperforming the Quick Setup

- 1 Press **DVD/CD**.
- 2 Press  $\square$  **DISPLAY** while the system is in stop mode.
- 3 Press  $\uparrow/\downarrow$  to select  [**SETUP**], then press  $\oplus$ .
- 4 Press  $\uparrow/\downarrow$  to select [**QUICK**], then press  $\oplus$ .  
Perform the Quick Setup following the procedure of "Performing the Quick Setup" (page 30).

## Set the System to Standby Mode Automatically

The system enters standby mode automatically when you do not operate the system for about 30 minutes and the system is not outputting sound for about 30 minutes. "AUTO STBY" begins to flash in the front panel display about 2 minutes before the system enters standby mode.

You can turn the auto standby function on/off.

- 1 Press **SYSTEM MENU**.
- 2 Press  $\uparrow/\downarrow$  to select "AUTO STBY," then press  $\oplus$  or  $\rightarrow$ .  
The selected item appears in the front panel display.
- 3 Press  $\uparrow/\downarrow$  to select the setting, then press  $\oplus$ .
  - "ON": On.
  - "OFF": Off.
- 4 Press **SYSTEM MENU**.

# Performing Further Settings

You can make various adjustments to items such as picture and sound.  
Displayed items vary depending on the area.

**Note**

- Playback settings stored in the disc take priority over the Setup Display settings and not all the functions described may work.

- 1** Press DVD/CD.
- 2** Press **DISPLAY** while the system is in stop mode.
- 3** Press  $\uparrow/\downarrow$  to select **[SETUP]**, then press  $\oplus$ .
- 4** Press  $\uparrow/\downarrow$  to select **[CUSTOM]**, then press  $\oplus$ .
- 5** Press  $\uparrow/\downarrow$  to select the setup item, then press  $\oplus$ .
  - [LANGUAGE SETUP] (page 62)
  - [VIDEO SETUP] (page 63)
  - [HDMI SETUP] (page 63)
  - [AUDIO SETUP] (page 65)
  - [SYSTEM SETUP] (page 66)
  - [SPEAKER SETUP] (page 67)

Example: [VIDEO SETUP]

Selected item

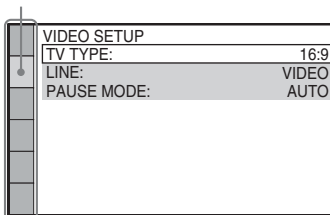

Setup items

## 6 Press $\uparrow/\downarrow$ to select an item, then press $\oplus$ .

The options for the selected item appear.  
Example: [TV TYPE]

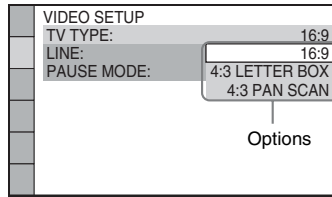

## 7 Press $\uparrow/\downarrow$ to select a setting, then press $\oplus$ .

The setting is selected and setup is complete.  
Example: [4:3 LETTER BOX]

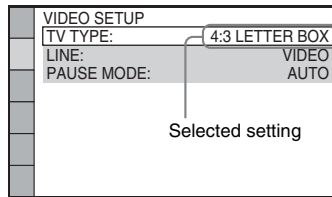

## To reset all of the [SETUP] settings

To reset all of the [SETUP] settings, see [RESET] (page 67).

## Setting the display or sound track language

### [LANGUAGE SETUP]

Set various languages for the on-screen display or sound track.

### ■ [OSD] (On-Screen Display)

You can switch the display language on the TV screen.

### ■ [MENU]

You can switch the language for the disc's menu.

**[AUDIO] DVD-V**

You can switch the language of the sound track. When you select [ORIGINAL], the language given priority on the disc is selected.

**[SUBTITLE] DVD-V**

You can switch the language of the subtitles recorded on the DVD VIDEO. When you select [AUDIO FOLLOW], the language for the subtitles changes according to the language you selected for the sound track.

**Note**

• When you select a language in [MENU], [AUDIO], or [SUBTITLE] that is not recorded on the DVD VIDEO, one of the recorded languages will be automatically selected (depending on the disc, the language may not be selected automatically).

**Tip**

• If you select [OTHERS →] in [MENU], [AUDIO], and [SUBTITLE], select and enter a language code from “Language Code List” (page 80) using the number buttons.

## Settings for the display

**[VIDEO SETUP]**

Select settings according to your TV.

**[TV TYPE]**

You can select the aspect ratio of the connected TV.

[16:9]: Select this when you connect a wide-screen TV or a TV with a wide-screen mode.



[4:3 LETTER BOX]: Select this when you connect a 4:3 standard TV. The system displays a wide picture with bands on the upper and lower portions of the TV screen.



[4:3 PAN SCAN]: Select this when you connect a 4:3 standard TV. The system automatically displays a wide picture on the entire screen and cuts off the portions that do not fit.

**[LINE]**

You can select the output method for video signals from the EURO AV ⇨ OUTPUT (TO TV) jack.

[VIDEO]: The system outputs video signals.

[RGB]: The system outputs RGB signals.

**Note**

- If your TV does not accept RGB signals, no picture appears on the TV screen even if you select [RGB]. Refer to the operating instructions of your TV.
- You cannot select [RGB] while “HDMI” is lit. [RGB] automatically switches to [VIDEO] when you turn on any connected HDMI equipment.

**[PAUSE MODE] DVD-V**

**(DVD VIDEO/DVD-R/DVD-RW only)**

You can select the picture in pause mode.

[AUTO]: The picture, including subjects that move dynamically, is output with no jitter. This setting is for normal usage.

[FRAME]: The picture, including subjects that do not move dynamically, is output in high resolution.

## Settings for HDMI

**[HDMI SETUP]****[HDMI RESOLUTION]**

You can select the type of video signal that is output from the HDMI OUT jack.

[AUTO (1920 × 1080p)]: The system outputs the optimal video signal for the connected TV.

[1920 × 1080i]: The system outputs 1920 × 1080i\* video signals.

[1280 × 720p]: The system outputs 1280 × 720p\* video signals.

[720 × 480p]\*\*: The system outputs 720 × 480p\* video signals.

\* i: interlace, p: progressive

\*\* Depending on the area, [720 × 480/576p] may appear.

---

### ■ [CONTROL FOR HDMI]

This function is available when you connect the system and TV that is compatible with the Control for HDMI function with an HDMI cable.

[OFF]: Off.

[ON]: On. You can operate mutually between components that are connected with an HDMI cable.

---

### ■ [VOLUME LIMIT]

When the System Audio Control (page 52) is activated, loud sound may be output depending on the volume level of the system. You can prevent this by limiting the maximum level of the volume when the System Audio Control function activates.

[OFF]: Off.

[LEVEL3]: Maximum volume level is set to 10.

[LEVEL2]: Maximum volume level is set to 15.

[LEVEL1]: Maximum volume level is set to 20.

#### Note

- This function is available only when [CONTROL FOR HDMI] is set to [ON].

---

### ■ [AUDIO RETURN CHANNEL]

This function is available when you connect the system and TV that is compatible with the Audio Return Channel function.

[AUTO]: The system can receive the digital audio signal of your TV via an HDMI cable automatically.

[Off]: Off.

#### Note

- This function is available only when [CONTROL FOR HDMI] is set to [ON].

---

### ■ [YCbCr/RGB (HDMI)]

You can select the type of HDMI signal output from the HDMI OUT jack.

[YCbCr]: The system outputs YCbCr signals.

[RGB]: The system outputs RGB signals.

---

### ■ [AUDIO (HDMI)]

You can select the audio output status from the HDMI OUT jack.

[OFF]: The system does not output sound from the HDMI OUT jack.

[ON]: The system outputs audio signals by converting Dolby Digital, DTS, or 96 kHz/24-bit PCM signals to 48 kHz/16-bit PCM.

#### Note

- When you set the function to other than “DVD/CD” or “USB,” the system does not output the sound from the HDMI OUT jack even if you set [AUDIO (HDMI)] to [ON].

---

### ■ [JPEG RESOLUTION]

You can select the resolution of JPEG image files output from the HDMI OUT jack.

[SD ]: The system outputs standard resolution with a black frame.

[HD ]: The system outputs HD resolution with a black frame.

[HD]: The system outputs the HD resolution without a black frame.

[(1920 × 1080i) HD ]: The system outputs full size HD resolution with a black frame.

[(1920 × 1080i) HD]: The system outputs full size HD resolution without a black frame.

#### Note

- [JPEG RESOLUTION] is effective only when you set [TV TYPE] in [VIDEO SETUP] to [16:9], and you set [HDMI RESOLUTION] in [HDMI SETUP] to other than [720 × 480p] or [720 × 480/576p].
- You can select [(1920 × 1080i) HD ] or [(1920 × 1080i) HD] only when you set [HDMI RESOLUTION] in [HDMI SETUP] to [1920 × 1080i].
- The HDMI signal will stop momentarily when:
  - the system is loading or unloading a DATA CD or DATA DVD.
  - you connect or remove a USB device.



## Settings for the audio

### [AUDIO SETUP]

#### ■ [SPEAKER FORMATION]

Depending on the shape of the room, you may not be able to install some speakers. For better surround sound, Sony recommends that first you decide the position of the speakers.

**1** Press  $\leftarrow/\rightarrow$  to select a setting, then press  $\oplus$ .

- [STANDARD]: Select this when you install all the speakers normally.
- [NO CENTER]: Select this when you install the front and surround speakers only.
- [NO SURROUND]: Select this when you install the center and front speakers only.
- [FRONT ONLY]: Select this when you install the front speakers only.
- [ALL FRONT]: Select this when you install all the speakers in front of the listening position.
- [ALL FRONT - NO CENTER]: Select this when you install the front and surround speakers in front of the listening position.

**2** Press  $\leftarrow/\rightarrow$  to select [YES] or [NO], then press  $\oplus$ .

- [YES]: Continue with [AUTO CALIBRATION]. Follow the Steps of [AUTO CALIBRATION] below.
- [NO]: Exit [SPEAKER FORMATION].

#### ■ [AUTO CALIBRATION]

D. C. A. C. (Digital Cinema Auto Calibration) can set the appropriate surround sound automatically.

**1** Connect the calibration mic (supplied) to the A.CAL MIC jack on the front panel.

Set up the calibration mic at ear level using a tripod, etc. (not supplied).

The front of each speaker should face the calibration mic, and there should be no

obstruction between the speakers and the calibration mic.

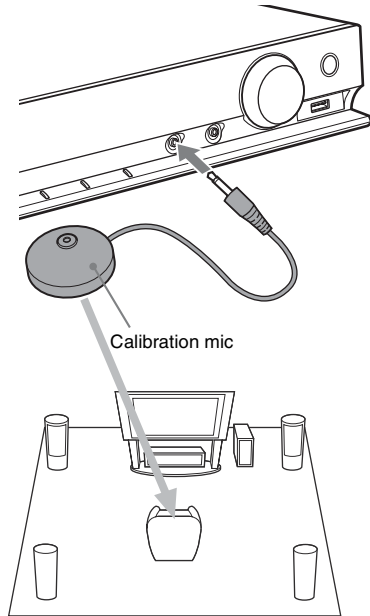

**2** Press  $\leftarrow/\rightarrow$  to select [YES], then press  $\oplus$ .

[AUTO CALIBRATION] starts.

Be quiet during the measurement.

#### Note

- The environment of the room in which the system is installed may affect measurements. When the measurements differ considerably from the status of the speaker installation, perform the speaker settings manually by following "Settings for the speakers" (page 67).

**3** Press  $\leftarrow/\rightarrow$  to select [YES] or [NO], then press  $\oplus$ .

**4** Disconnect the calibration mic when the measurement completes correctly.

#### Note

- The system outputs a loud test sound when [AUTO CALIBRATION] starts. You cannot turn the volume down. Give consideration to children and neighbors.
- The measurement for [SUBWOOFER] is always [YES] and [SPEAKER SETUP] returns to the default setting when you perform [AUTO CALIBRATION].

---

## ■ [AUDIO DRC] **DVD-V**

You can compress the dynamic range of the sound track. [AUDIO DRC] is useful for watching movies at low volume late at night.

[OFF]: No compression of dynamic range.

[STANDARD]: The system reproduces the sound track with the kind of dynamic range that the recording engineer intended.

[MAX]: The system compresses dynamic range fully.

### Note

- [AUDIO DRC] works only for Dolby Digital.

---

## ■ [TRACK SELECTION] **DVD-V**

You can give the sound track which contains the highest number of channels priority when multiple audio formats (PCM, DTS, Dolby Digital, or MPEG audio) are recorded.

[OFF]: Off.

[AUTO]: The system selects the sound track automatically according to the priority.

### Note

- When you set the item to [AUTO], the language may change. The [TRACK SELECTION] setting has higher priority than the [AUDIO] settings in [LANGUAGE SETUP] (page 62). (Depending on the disc, this function may not work.)

## Other Settings



### [SYSTEM SETUP]

---

## ■ [SCREEN SAVER]

You can reduce the damage to the display device (ghosting). Press any button (e.g., ►) to cancel the screen saver.

[ON]: The screen saver image appears if you do not operate the system for about 15 minutes.

[OFF]: Off.

---

## ■ [BACKGROUND]

You can select the background color or picture on the TV screen.

[JACKET PICTURE]: The jacket picture (still picture) appears, but only when the jacket picture is already recorded on the disc (CD-EXTRA, etc.). If the disc does not contain a jacket picture, a preset picture stored in the system appears.

[GRAPHICS]: A preset picture stored in the system appears.

[BLUE]: The background is blue.

[BLACK]: The background is black.



---

## ■ [PARENTAL CONTROL]

The [PARENTAL CONTROL] function allows you to restrict playback of DVDs that have ratings. Scenes may be blocked or replaced with different scenes.



**1 Enter or re-enter your 4-digit password using the number buttons, then press .**

**2 Press  to select [STANDARD], then press .**

**3 Press  to select a geographic area as the playback limitation level, then press .**

When you select [OTHERS →], select and enter a standard code from “Parental Control Area Code List” (page 80) using the number buttons.

**4 Press  to select [LEVEL], then press .**

**5 Press  to select the desired level, then press .**

The lower the value, the stricter the limitation.

### To turn off the [PARENTAL CONTROL] function

Set [LEVEL] to [OFF] in Step 5.

### To play a disc for which [PARENTAL CONTROL] is set

When you load the disc and press ►, the display for entering your password appears. Enter your 4-digit password using the number buttons, then press .

### Tip

- If you forget your password, enter “199703” using the number buttons, then press . The display will ask you to enter a new 4-digit password. After you

enter a new 4-digit password, replace the disc in the unit and press ►. When the display for entering your password appears, enter your new password.

## Changing the password

- 1 Enter your 4-digit password using the number buttons, then press ⊕.**
- 2 Press ↑/↓ to select [CHANGE PASSWORD →], then press ⊕.**
- 3 Enter a new 4-digit password using the number buttons, then press ⊕.**

If you make a mistake entering your password, press ← before you press ⊕, then input the correct number.
- 4 To confirm your password, re-enter it using the number buttons, then press ⊕.**

---

### ■ [DivX (R) VOD]

#### (Except for United Kingdom and North American models)

You can display the registration or deactivation code for this system, or deactivate this system after activation.

#### To display the registration code

Press ↑/↓ to select [Registration Code →], then press ⊕.

#### To deactivate the system

Press ←/→ to select [YES] or [NO], then press ⊕.

- [YES]: The system is deactivated and the deactivation code is displayed.
- [NO]: The system returns to the previous display.

#### To display the deactivation code again after deactivation

Press ↑/↓ to select [Deactivation Code →], then press ⊕.

For more information, go to <http://www.divx.com> on the Internet.

---

### ■ [MULTI-DISC RESUME] **DVD-V** **VIDEO CD**

This system recalls the point where you stopped the disc the last time it was played and resumes playback from that point the next time you insert the same disc.

[ON]: The system stores the resume points in memory for up to 10 discs.

[OFF]: The system does not store the resume points in memory. Playback restarts at the resume point only for the current disc in the unit.

#### Note

- When the resume playback memory is full, the resume playback point for the earliest disc is deleted.

---

### ■ [RESET]

You can return the [SETUP] settings other than [PARENTAL CONTROL] to the default settings.

Press ←/→ to select [YES], then press ⊕.

You can also quit the process and return to the Control Menu by selecting [NO] here. Do not press I/⏻ while resetting the system as it takes a few seconds to complete.

#### Note

- The [MEDIA], [INTERVAL], [EFFECT], and [MULTI/2CH] settings also return to the default settings.

## Settings for the speakers

### **B-B** [SPEAKER SETUP]

You can adjust the speaker settings manually without performing the Quick Setup. Select the speakers you will use, set the speaker distance from your listening position, and then adjust the sound level for each speaker. You can adjust the sound level by using the [TEST TONE] function.

---

### ■ [CONNECTION]

#### [FRONT]

[YES]

#### [CENTER]

[YES]: Normally select this.

[NONE]: Select this if no center speaker is used.

#### [SURROUND]

[YES]: Normally select this.

[NONE]: Select this if no surround speakers are used.

---

## [SUBWOOFER]

### [YES]

#### Note

- When you change the [CONNECTION] setting, the [STANDARD] of [SPEAKER FORMATION] setting remains the same, but the other settings of [SPEAKER FORMATION] return to [STANDARD].
- 

### ■ [DISTANCE (FRONT)]

Set the distance of the front and center speakers from the listening position.

For the best possible surround sound, place all speakers at the same distance from the listening position. The distance can be between 1.0 to 7.0 meters<sup>1)</sup> (3 to 23 ft) for the front speakers, and 0.0 to 7.0 meters<sup>2)</sup> (0 to 23 ft) for the center speaker.

If you cannot place the center speaker at the same distance, you can move the center speaker up to 1.6 meters closer to the listening position.

[L/R] 3.0 m/10 ft: Set the front speaker distance.

[CENTER] 3.0 m/10 ft: Set the center speaker distance.

<sup>1)</sup>0.9 to 6.9 meters for North American models.

<sup>2)</sup>0.0 to 6.9 meters for North American models.

---

### ■ [DISTANCE (SURROUND)]

Set the distance for the surround speakers from the listening position.

For the best possible surround sound, place all speakers at the same distance from the listening position. The distance can be between 1.0 to 7.0 meters\* (0 to 23 ft).

If you cannot place surround speakers at the same distance, you can move the surround speakers up to 5.0 meters (16 ft) closer to the listening position.

[L/R] 3.0 m/10 ft: Set the surround speaker distance.

\* 0.0 to 6.9 meters for North American models.

#### Note

- Depending on the input stream, the [DISTANCE] setting may not be effective.
- 

### ■ [LEVEL (FRONT)]

You can adjust the sound level of the front speakers, center speaker, and subwoofer. You can set the parameters from -6.0 dB to 0 dB for [L/R], and from -6.0 dB to +6.0 dB for [CENTER] and [SUBWOOFER]. Be sure to set [TEST TONE] to [ON] for easy adjustment.

[L/R] 0.0 dB: Set the front speaker level.

[CENTER] 0.0 dB: Set the center speaker level.

[SUBWOOFER] +2.0 dB: Set the subwoofer level.

---

### ■ [LEVEL (SURROUND)]

You can adjust the sound level of the surround speakers. You can set the parameter from -6.0 dB to +6.0 dB. Set [TEST TONE] to [ON] for easy adjustment.

[L/R] 0.0 dB: Set the surround speaker level.

---

### ■ [TEST TONE]

You can adjust the sound level of the speakers by using the [TEST TONE] function.

[OFF]: The test tone is not emitted from the speakers.

[ON]: The test tone is emitted from each speaker in sequence while adjusting the level.

Adjust the sound level as follows.

- 1** Set the [TEST TONE] to [ON].
- 2** Press  $\leftarrow/\uparrow/\downarrow/\rightarrow$  repeatedly to select the desired speaker and the level, then press  $\oplus$ .
- 3** Repeat Step 2.
- 4** Press  $\leftarrow/\uparrow/\downarrow/\rightarrow$  to set [TEST TONE] to [OFF] after adjusting the speaker level.

## Precautions

### On power sources

- Unplug the unit from the wall outlet (mains) if you do not intend to use it for an extended period of time. To disconnect the cord, pull it out by the plug, never by the cord.

### On placement

- Place the system in a location with adequate ventilation to prevent heat build-up in the system.
- At high volume, over long periods of time, the cabinet becomes hot to the touch. This is not a malfunction. However, touching the cabinet should be avoided. Do not place the system in a confined space where ventilation is poor as this may cause overheating.
- Do not block the ventilation slots by putting anything on the system. The system is equipped with a high power amplifier. If the ventilation slots are blocked, the system can overheat and malfunction.
- Do not place the system on surfaces (rugs, blankets, etc.) or near materials (curtains, draperies) that may block the ventilation slots.
- Do not install the system near heat sources such as radiators, or air ducts, or in a place subject to direct sunlight, excessive dust, mechanical vibration, or shock.
- Do not install the system in an inclined position. It is designed to be operated in a horizontal position only.
- Keep the system and discs away from components with strong magnets, such as microwave ovens, or large loudspeakers.
- Do not place heavy objects on the system.

### On operation

- If the system is brought directly from a cold to a warm location, or is placed in a very damp room, moisture may condense on the lenses inside the unit. Should this occur, the system may not operate properly. In this case, remove the disc and leave the system turned on for about half an hour until the moisture evaporates.
- If anything falls into the cabinet, unplug the unit and have it checked by qualified personnel before operating it any further.

### On adjusting volume

- Do not turn up the volume while listening to a section with very low level inputs or no audio signals. If you do, the speakers may be damaged when a peak level section is suddenly played.

### On cleaning

- Clean the cabinet, panel, and controls with a soft cloth slightly moistened with a mild detergent solution. Do not use any type of abrasive pad, scouring powder or solvent such as alcohol or benzene.  
If you have any questions or problems concerning your system, please consult your nearest Sony dealer.

### On cleaning discs, disc/lens cleaners

- **Do not use cleaning discs or disc/lens cleaners (including wet or spray types). These may cause the apparatus to malfunction.**

### On your TV's color

- If the speakers should cause your TV screen to have color irregularity, turn off the TV then turn it on after 15 to 30 minutes. If color irregularity should persist, place the speakers further away from your TV set.

#### IMPORTANT NOTICE

Caution: This system is capable of holding a still video image or on-screen display image on your television screen indefinitely. If you leave the still video image or on-screen display image displayed on your TV for an extended period of time you risk permanent damage to your television screen. Projection televisions are especially susceptible to this.

### On moving the system

- Before moving the system, make sure that there is no disc inserted, and remove the AC power cord (mains lead) from the wall outlet (mains).

## Notes about the Discs

### On handling discs

- To keep the disc clean, handle the disc by its edge. Do not touch the surface.
- Do not stick paper or tape on the disc.



- Do not expose the disc to direct sunlight or heat sources such as hot air ducts, or leave it in a car parked in direct sunlight as the temperature may rise considerably inside the car.
- After playing, store the disc in its case.

### On cleaning

- Before playing, clean the disc with a cleaning cloth.  
Wipe the disc from the center out.



- Do not use solvents such as benzine, thinner, commercially available cleaners, or anti-static spray intended for vinyl LPs.

This system can only play a standard circular disc. Using neither standard nor circular discs (e.g., card, heart, or star shape) may cause a malfunction.

Do not use a disc that has a commercially available accessory attached, such as a label or ring.

# Troubleshooting

If you experience any of the following difficulties while using the system, use this troubleshooting guide to help remedy the problem before requesting repairs. Should any problem persist, consult your nearest Sony dealer.

Note that if service personnel changes some parts during repair, these parts may be retained.

When you install the S-AIR sub unit (not supplied), in the event of a problem with the S-AIR function, have a Sony dealer check the entire system together (main unit and S-AIR sub unit). (DAV-DZ730 only)

## General

Symptom	Problems and solutions
The power is not turned on.	<ul style="list-style-type: none"><li>• Check that the AC power cord (mains lead) is connected securely.</li></ul>
The remote does not function.	<ul style="list-style-type: none"><li>• The distance between the remote and the unit is too far.</li><li>• The batteries in the remote are weak.</li></ul>
The system does not work normally.	<ul style="list-style-type: none"><li>• Disconnect the AC power cord (mains lead) from the wall outlet (mains), then reconnect after several minutes.</li><li>• Perform the following procedure. (Note that the system parameters, such as preset stations, return to the default settings.)<ol style="list-style-type: none"><li>① Press <b>I/⏻</b> to turn on the system.</li><li>② Press <b>▶</b>, <b>FUNCTION</b>, and <b>I/⏻</b> on the unit at the same time. "COLD RESET" appears in the front panel display.</li></ol></li></ul>
After performing [AUTO CALIBRATION], [NONE] appears in the [Measurement Complete.] display.	<ul style="list-style-type: none"><li>• Check the speaker connection (page 25).</li><li>• Do not install the speaker in another room.</li></ul>

## Picture

Symptom	Problems and solutions
There is no picture.	<ul style="list-style-type: none"><li>• The video input on your TV is not set so that you can view pictures from the system.</li><li>• Check the output method on your system.</li></ul>
There is no picture when you make an HDMI cable connection.	<ul style="list-style-type: none"><li>• The unit is connected to an input device that is not HDCP (High-bandwidth Digital Content Protection) compliant ("HDMI" on the front panel does not light up).</li><li>• If the HDMI OUT jack is used for video output, change the type of video signal output from the HDMI OUT jack (page 63). Connect your TV and the unit using a video jack other than HDMI OUT, and switch your TV's input to the connected video input so that you can see the on-screen displays. Change the type of video signal output from the HDMI OUT jack, and switch your TV's input back to HDMI. If the picture still does not appear, repeat the Steps and try other options.</li></ul>
Picture noise appears.	<ul style="list-style-type: none"><li>• If the signal from the EURO AV <b>⇄</b> OUTPUT (TO TV) jack is distorted, change the type of video signal output from the HDMI OUT jack by setting [HDMI RESOLUTION] in [HDMI SETUP] to [720 × 480p]* (page 63). * Depending on the area, [720 × 480/576p] may appear.</li></ul>
An image is not displayed on the entire TV screen.	<ul style="list-style-type: none"><li>• Check the setting of [TV TYPE] in [VIDEO SETUP] (page 63).</li><li>• The aspect ratio on the disc is fixed.</li></ul>

<b>Symptom</b>	<b>Problems and solutions</b>
Color irregularity occurs on the TV screen.	<p>The system's speakers contain magnet parts, so magnetic distortion may occur. When color irregularity occurs on the TV screen, check the following items.</p> <ul style="list-style-type: none"> <li>• Install the speakers at least 0.3 meters (1.0 ft) from your TV set.</li> <li>• If the color irregularity persists, turn off your TV set once, then turn it on after 15 to 30 minutes.</li> <li>• Make sure that no magnetic object (magnetic latch on a TV stand, health care device, toy, etc.) is placed near the speakers.</li> <li>• Reposition the speakers farther away from your TV set.</li> </ul>
Playback picture becomes distorted.	<ul style="list-style-type: none"> <li>• Set [YCbCr] in [YCbCr/RGB (HDMI)] to [RGB] (page 64).</li> </ul>

## **Sound**

<b>Symptom</b>	<b>Problems and solutions</b>
There is no sound.	<ul style="list-style-type: none"> <li>• The speaker cord is not connected securely.</li> <li>• Check the speaker settings (page 67).</li> </ul>
There is no sound when the component (digital satellite receiver, PlayStation 3, etc.) is connected directly to your TV via HDMI.	<ul style="list-style-type: none"> <li>• Check the following status. <ul style="list-style-type: none"> <li>– Connect the system and TV with a SCART (EURO AV) cable (page 26) and select the "TV" function.</li> <li>– Disable your TV's speakers.</li> </ul> </li> </ul>
There is no sound from the DIGITAL IN OPTICAL jack.	<ul style="list-style-type: none"> <li>• The sampling frequency of the input stream is more than 48 kHz.</li> </ul>
There is no digital sound from the HDMI OUT jack when using the Audio Return Channel function.	<ul style="list-style-type: none"> <li>• Set [AUDIO RETURN CHANNEL] in [HDMI SETUP] to [AUTO] (page 64).</li> <li>• Set [CONTROL FOR HDMI] in [HDMI SETUP] to [ON] (page 64).</li> <li>• Make sure that your TV is compatible with the Audio Return Channel function.</li> <li>• Make sure that an HDMI cable is connected to a jack on your TV that is compatible with the Audio Return Channel function.</li> <li>• The sampling frequency of the input stream is more than 48 kHz.</li> </ul>
The system does not output sound correctly when connected to a set-top box.	<ul style="list-style-type: none"> <li>• Set [AUDIO RETURN CHANNEL] in [HDMI SETUP] to [OFF] (page 64).</li> </ul>
Severe hum or noise is heard.	<ul style="list-style-type: none"> <li>• Move your TV away from the audio components.</li> <li>• Clean the disc.</li> </ul>
The sound loses stereo effect when you play a VIDEO CD, a CD, or an audio file.	<ul style="list-style-type: none"> <li>• Select stereo sound by pressing AUDIO (page 37).</li> </ul>
There is no sound or the volume level is very low from a certain speaker or all the speakers.	<ul style="list-style-type: none"> <li>• Check the surround setting (page 48).</li> <li>• Check the speaker connections and settings (pages 25, 67).</li> <li>• Depending on the DVD, the output signal may not be the entire 5.1 channel.</li> <li>• A 2 channel source is being played.</li> <li>• Check the wireless setting (page 53).</li> </ul>
The sound comes from the center speaker only.	<ul style="list-style-type: none"> <li>• Depending on the disc, the sound may come from the center speaker only.</li> </ul>



Symptom	Problems and solutions
There is no system sound from your TV.	<ul style="list-style-type: none"> <li>• Set [AUDIO (HDMI)] in [HDMI SETUP] to [ON] (page 64).</li> <li>• The HDMI OUT jack does not output Super Audio CD sound.</li> <li>• Perform the following procedure.               <ol style="list-style-type: none"> <li>① Turn the system off and on again.</li> <li>② Turn the connected component off and on again.</li> <li>③ Disconnect and then connect the HDMI cable again.</li> </ol> </li> </ul>
The sound of files played from a DATA CD/DATA DVD/USB device is distorted.	<ul style="list-style-type: none"> <li>• The bit rate used when encoding the audio files was low. Transfer audio files encoded with higher bit rates onto the DATA CD/DATA DVD/USB device.</li> </ul>
There is noise or the sound skips while playing a USB device.	<ul style="list-style-type: none"> <li>• Copy the files to your computer, format the USB device in FAT12, FAT16, or FAT32 format, and transfer the files to the USB device again.</li> </ul>

## Disc playback

Symptom	Problems and solutions
A disc does not play.	<ul style="list-style-type: none"> <li>• The region code on the DVD does not match the system.</li> <li>• Moisture has condensed inside the unit and may cause damage to the lenses. Remove the disc and leave the unit turned on for about half an hour.</li> </ul>
The language for the sound track or subtitle cannot be changed.	<ul style="list-style-type: none"> <li>• Set the language via the disc's menu.</li> </ul>
A disc does not start playing from the beginning.	<ul style="list-style-type: none"> <li>• While in stop mode, press <b>■</b> on the unit or the remote and then start playback (page 35).</li> </ul>
A DATA CD/DATA DVD cannot be played.	<ul style="list-style-type: none"> <li>• The DATA CD is not recorded in ISO 9660 Level 1/Level 2, or Joliet.</li> <li>• The DATA DVD is not recorded in UDF (Universal Disk Format).</li> </ul>
A file cannot be played.	<ul style="list-style-type: none"> <li>• The extension of the file name or file format is not correct. See "Playable Discs/Files on a USB Device" (page 6).</li> <li>• Check the [MEDIA] setting (page 35).</li> <li>• The system can play to a depth of 8 folders only.</li> <li>• Check that the number of folders is 200 or less.</li> <li>• Check that the number of audio files/JPEG image files in the folder is 150 or less.</li> </ul>
A JPEG image file cannot be viewed.	<ul style="list-style-type: none"> <li>• The JPEG image file is larger than 3,072 (width) × 2,048 (height) pixels in normal format, or more than 2,000,000 pixels in progressive format which is mainly used on Internet Web sites.</li> </ul>
A video file cannot be played.	<ul style="list-style-type: none"> <li>• The video file is larger than 720 (width) × 576 (height).</li> </ul>
The titles of folders/files/file names are not displayed correctly.	<ul style="list-style-type: none"> <li>• The system can only display numbers and letters of the alphabet. Other characters are displayed as [ _ ].</li> </ul>
File names are not displayed properly.	<ul style="list-style-type: none"> <li>• The character codes that can be displayed by this system are numbers and letters of the alphabet only. Other characters are not displayed correctly.</li> </ul>

## USB playback

Symptom	Problems and solutions
A USB device does not start playing from the beginning.	<ul style="list-style-type: none"> <li>• While in stop mode, press <b>■</b> on the unit or the remote and then start playback (page 35).</li> </ul>

Symptom	Problems and solutions
A USB device cannot be played.	<ul style="list-style-type: none"> <li>• USB devices formatted with file systems other than FAT12, FAT16, or FAT32 are unsupported.*</li> <li>* This system supports FAT12, FAT16, and FAT32, but some USB devices may not support all of these. For details, refer to the operating instructions of the USB device or contact the manufacturer.</li> <li>• If you use a partitioned USB device, only audio files on the first partition can be played.</li> </ul>
A file cannot be played.	<ul style="list-style-type: none"> <li>• The extension of the file name or file format is not correct. See “Playable Discs/Files on a USB Device” (page 6).</li> <li>• Check the [MEDIA] setting (page 35).</li> <li>• The system can play to a depth of 8 folders only.</li> <li>• Check that the number of folders is 200 or less.</li> <li>• Check that the number of audio files/JPEG image files in the folder is 150 or less.</li> <li>• Files that are encrypted or protected by passwords, etc. cannot be played.</li> </ul>
A JPEG image file cannot be viewed.	<ul style="list-style-type: none"> <li>• The JPEG image file is larger than 3,072 (width) × 2,048 (height) pixels in normal format, or more than 2,000,000 pixels in progressive format which is mainly used on Internet Web sites.</li> </ul>
A video file cannot be played.	<ul style="list-style-type: none"> <li>• The video file is larger than 720 (width) × 576 (height).</li> </ul>
A WMA file cannot be played.	<ul style="list-style-type: none"> <li>• A WMA file that is in WMA DRM, WMA Lossless, or WMA PRO format cannot be played.</li> </ul>
An AAC file cannot be played.	<ul style="list-style-type: none"> <li>• An AAC file that is in AAC DRM or AAC Lossless format cannot be played.</li> </ul>
The titles of folders/files/file names are not displayed correctly.	<ul style="list-style-type: none"> <li>• The system can only display numbers and letters of the alphabet. Other characters are displayed as [_].</li> </ul>
File names are not displayed properly.	<ul style="list-style-type: none"> <li>• The character codes that can be displayed by this system are numbers and letters of the alphabet only. Other characters are not displayed correctly.</li> </ul>
It takes time until playback starts.	<ul style="list-style-type: none"> <li>• After the system reads all files on the USB device, playback may take more time than usual if: <ul style="list-style-type: none"> <li>– there are many folders or files on the USB device.</li> <li>– the folder or file organization structure is very complex.</li> <li>– the memory capacity is very large.</li> <li>– the file size is extremely large.</li> <li>– the internal memory is fragmented.</li> </ul> </li> <li>• The system is playing an audio file in AAC format.</li> </ul>
A USB device which has been used on another device does not work.	<ul style="list-style-type: none"> <li>• It may be recorded in an unsupported format. If so, first take the precaution of backing up important files on the USB device by copying them to your computer hard disk. Next, format the USB device in FAT12, FAT16, or FAT32 format, and transfer the files to the USB device again.</li> </ul>

## Audio track/file transfer

Symptom	Problems and solutions
You cannot start transferring onto a USB device.	<ul style="list-style-type: none"> <li>• The following problems may have occurred. <ul style="list-style-type: none"> <li>– The USB device is full.</li> <li>– The number of audio files and folders on the USB device has reached the upper limit.</li> <li>– The USB device is write-protected.</li> </ul> </li> </ul>

Symptom	Problems and solutions
Transferring stops before it is finished.	<ul style="list-style-type: none"> <li>• The communication speed of the USB device is extremely slow. Connect a USB device that this system can play.</li> <li>• If the transferring and erasing operations are repeated multiple times, the file structure within the USB device becomes complex. Follow the procedure in the operating instructions of the USB device to format the USB device. If the problem persists, contact your nearest Sony dealer.</li> <li>• The USB device is full.</li> <li>• The number of audio files and folders on the USB device has reached the upper limit.</li> </ul>
Transferring to a USB device results in an error.	<ul style="list-style-type: none"> <li>• The USB device was disconnected or the power was turned off during erasing. Delete the partially-erased file. If this does not fix the problem, the USB device may be broken. Follow the procedure in the operating instructions of the USB device to format the USB device. If the problem persists, contact your nearest Sony dealer.</li> </ul>
Audio files or folders on the USB device cannot be erased.	<ul style="list-style-type: none"> <li>• Check if the USB device is write-protected.</li> </ul>

## Tuner

Symptom	Problems and solutions
Radio stations cannot be tuned in.	<ul style="list-style-type: none"> <li>• Check that the antenna (aerial) is connected securely. Adjust the antenna (aerial) or connect an external antenna (aerial) if necessary.</li> <li>• The signal strength of the stations is too weak (when tuning in with automatic tuning). Use direct tuning.</li> </ul>
FM reception is poor.	<ul style="list-style-type: none"> <li>• Use a 75-ohm coaxial cable (not supplied) to connect the unit to an outdoor FM antenna (aerial).</li> </ul>
RDS does not work properly.	<ul style="list-style-type: none"> <li>• The station you are tuned to is not transmitting the RDS signal properly, or the signal strength is weak.</li> </ul>



## S-AIR (DAV-DZ730 only)

Symptom	Problems and solutions
There is no sound or noise is heard from the S-AIR sub unit, or sound skips.	<ul style="list-style-type: none"> <li>• If you use another S-AIR main unit, place it more than 8 m (about 25 feet) away from the other S-AIR main unit you are using.</li> <li>• Place the S-AIR main unit and S-AIR sub unit closer together.</li> <li>• Avoid use of equipment that generates electromagnetic energy, such as a microwave oven.</li> <li>• Place the S-AIR main unit and S-AIR sub unit away from other wireless devices.</li> <li>• See “If wireless transmission is unstable” (page 56).</li> <li>• Change the S-AIR ID settings of the S-AIR main unit and S-AIR sub unit.</li> <li>• Turn off the system and S-AIR sub unit, then turn them on.</li> </ul>
The S-AIR function on the system menu cannot be operated.	<ul style="list-style-type: none"> <li>• Check that the wireless transceiver is inserted into the unit correctly (page 53).</li> </ul>

## Control for HDMI

Symptom	Problems and solutions
The Control for HDMI function does not work.	<ul style="list-style-type: none"> <li>• Set [CONTROL FOR HDMI] in [HDMI SETUP] to [ON] (page 64).</li> <li>• Make sure that the connected component is compatible with the [CONTROL FOR HDMI] function.</li> <li>• Check the connected component's setting for the Control for HDMI function. Refer to the operating instructions of the component.</li> <li>• If you change the HDMI connection, connect and disconnect the AC power cord (mains lead), or have a power failure, set [CONTROL FOR HDMI] in [HDMI SETUP] to [OFF], then set to [ON] (page 64).</li> <li>• For details, see "Using the Control for HDMI Function for "BRAVIA" Sync" (page 51).</li> </ul>
No sound is output from the system and TV while using the System Audio Control function.	<ul style="list-style-type: none"> <li>• Make sure that the connected TV is compatible with the System Audio Control function.</li> <li>• For details, see "Using the Control for HDMI Function for "BRAVIA" Sync" (page 51).</li> </ul>
Your TV's input select does not change automatically when you connect the system and TV with a SCART (EURO AV) cable.	<ul style="list-style-type: none"> <li>• Set [CONTROL FOR HDMI] in [HDMI SETUP] to [OFF] (page 64).</li> </ul>

## Messages

Symptom	Problems and solutions
"PROTECTOR" and "PUSH POWER" appear alternately.	<ul style="list-style-type: none"> <li>• Press  to turn off the system, and check the following items after "STANDBY" disappears. <ul style="list-style-type: none"> <li>– Are the + and – speaker cords short-circuited?</li> <li>– Is anything blocking the ventilation holes of the system?</li> <li>– After checking the above items and fixing any problems, turn on the system. If the cause of the problem cannot be found even after checking all the above items, consult your nearest Sony dealer.</li> </ul> </li> </ul>
"OVERLOAD," "REMOVE USB," then "PUSH POWER" appear.	<ul style="list-style-type: none"> <li>• A problem has been detected with the level of electrical current from the  (USB) port. Turn off the system and remove the USB device from the  (USB) port. Make sure there is no problem with the USB device. If this display pattern persists, contact your nearest Sony dealer.</li> </ul>
"LOCKED" appears and a disc cannot be ejected.	<ul style="list-style-type: none"> <li>• Contact your Sony dealer or local authorized Sony service facility.</li> </ul>
"DATA ERROR" appears.	<ul style="list-style-type: none"> <li>• The file you want to play is broken.</li> <li>• The file format does not match the extension of the file name. See "Playable Discs/Files on a USB Device" (page 6).</li> <li>• The JPEG image file format does not conform to DCF.</li> </ul>
"READING" is displayed for a long time while playing.	<ul style="list-style-type: none"> <li>• The reading process can take a long time if: <ul style="list-style-type: none"> <li>– there are many folders or files on the USB device.</li> <li>– the folder or file organization structure is very complex.</li> <li>– the memory capacity is very large.</li> <li>– the internal memory is fragmented.</li> </ul> </li> </ul>

## Self-diagnosis Function

### (When letters/numbers appear in the display)

When the self-diagnosis function is activated to prevent the system from malfunctioning, a 5-character service number (e.g., C 13 50) with a combination of a letter and 4 digits appears on the TV screen or front panel display. In this case, check the following table.

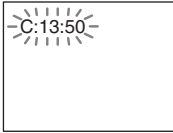

First 3 characters of the service number	Cause and/or corrective action
C 13	The disc is dirty. → Clean the disc with a soft cloth (page 70).
E XX (XX is a number)	To prevent a malfunction, the system has performed the self-diagnosis function. → Contact your nearest Sony dealer or local authorized Sony service facility and give the 5-character service number. Example: E 61 10

### When the version number appears on the TV screen

When you turn on the system, the version number [VER.X.XX] (X is a number) may appear on the TV screen. Although this is not a malfunction and for Sony service use only, normal system operation will not be possible. Turn off the system, and then turn on the system again to operate.



## Specifications

### Amplifier Section

POWER OUTPUT (rated):

Front L + Front R 108 W + 108 W (at 3 ohms, 1 kHz, 1% THD)

POWER OUTPUT (reference):

Front L/Front R/Center/  
Surround L/Surround R:  
167 watts (per channel at 3 ohms, 1 kHz)  
Subwoofer: 165 watts (at 3 ohms, 80 Hz)

Inputs (Analog)

TV (AUDIO IN)

Sensitivity: 450/250 mV

AUDIO IN

Sensitivity: 250/125 mV

Inputs (Digital)

TV (Audio Return Channel/OPTICAL IN)

Input Stream: Dolby  
Digital 5.1ch/DTS 5.1ch/  
Linear PCM 2ch  
(Sampling Frequency: less than 48 kHz)

### Super Audio CD/DVD System

Laser Diode Properties

Emission Duration:

Continuous

Laser Output: Less than 44.6 μW

\* This output is the value measurement at a distance of 200 mm from the objective lens surface on the Optical Pick-up Block with 7 mm aperture.

Signal format system

PAL/NTSC

### USB Section

↔ (USB) port:

Maximum current:

500 mA

### Tuner Section

System

PLL quartz-locked digital synthesizer

Tuning range

North American models: 87.5 MHz - 108.0 MHz (100 kHz step)

Other models:

87.5 MHz - 108.0 MHz (50 kHz step)

Antenna (aerial)

FM wire antenna (aerial)

Antenna (aerial) terminals

75 ohms, unbalanced

Intermediate frequency

10.7 MHz

### Video Section

Outputs

VIDEO: 1 Vp-p 75 ohms  
R/G/B: 0.7 Vp-p 75 ohms  
HDMI OUT: Type A (19 pin)

## Speakers

### Front

#### DAV-DZ330 (SS-TS102)

Speaker system	Full range Bass reflex
Speaker unit	65 mm cone type
Rated impedance	3 ohms
Dimensions (approx.)	103 mm × 164 mm × 85 mm (w/h/d)
Mass (approx.)	0.5 kg

#### DAV-DZ730 (SS-TS104)

Speaker system	Full range Bass reflex
Speaker unit	65 mm cone type
Rated impedance	3 ohms
Dimensions (approx.)	255 mm × 1,185 mm × 255 mm (speaker only: 113 mm × 645 mm × 77 mm) (w/h/d)
Mass (approx.)	3.1 kg

### Center (SS-CT101)

Speaker system	Full range Bass reflex, Magnetically Shielded
Speaker unit	65 mm cone type
Rated impedance	3 ohms
Dimensions (approx.)	265 mm × 94 mm × 70 mm (w/h/d)
Mass (approx.)	0.6 kg

### Surround (SS-TS102)

Speaker system	Full range Bass reflex
Speaker unit	65 mm cone type
Rated impedance	3 ohms
Dimensions (approx.)	103 mm × 164 mm × 85 mm (w/h/d)
Mass (approx.)	0.5 kg

### Subwoofer (SS-WS101)

Speaker system	Subwoofer Bass reflex
Speaker unit	160 mm cone type
Rated impedance	3 ohms
Dimensions (approx.)	169 mm × 300 mm × 320 mm (w/h/d)
Mass (approx.)	5.3 kg

### General

Power requirements	220 V - 240 V AC, 50/60 Hz
Power consumption	
DAV-DZ330	On: 170 W Standby: 0.25 W*
DAV-DZ730	On: 175 W Standby: 0.25 W*

\* Valid when the system is in the following status:

- "DEMO" is set to "OFF."
- [CONTROL FOR HDMI] is set to [OFF].

- "S-AIR STBY" is set to "STBY OFF." (DAV-DZ730 only)

Dimensions (approx.)	430 mm × 66 mm × 385 mm (w/h/d) incl. projecting parts
Mass (approx.)	4.4 kg

### Supported file format

#### MP3 (MPEG 1 Audio Layer-3)

File Extension:	mp3
Bitrate:	32 kbps - 320 kbps
Sampling frequencies:	32/44.1/48 kHz

#### WMA (USB device only)

File Extension:	wma
Bitrate:	48 kbps - 192 kbps
Sampling frequencies:	44.1 kHz

#### AAC (USB device only)

File Extension:	m4a
Bitrate:	48 kbps - 320 kbps
Sampling frequencies:	44.1 kHz

#### DivX (except for United Kingdom models)

File Extension:	avi/divx
Video codec:	DivX video
Bitrate:	10.08 Mbps (MAX)
Frame rate:	30 fps
Resolution:	720 × 576
Audio codec:	MP3

#### MPEG4

File format:	MP4 File Format
File Extension:	mp4/m4v
Video codec:	MPEG4 Simple Profile (AVC is not compatible.)
Bitrate:	4 Mbps
Frame rate:	30 fps
Resolution:	720 × 576
Audio codec:	AAC-LC (HE-AAC is not compatible.)
DRM:	Not compatible

Design and specifications are subject to change without notice.

- Standby power consumption 0.25 W.
- Halogenated flame retardants are not used in the certain printed wiring boards.
- Over 85% power efficiency of amplifier block is achieved with the full digital amplifier, S-Master.

## Playback Priority of File Types

The table below describes the playback priority of file types under the [MEDIA] setting.

File type on a disc or USB device	[MEDIA] setting				
	[VIDEO] <sup>1)</sup>		[MUSIC/PHOTO]	[PHOTO]	[MUSIC]
	Disc	USB device	Disc	Disc/USB device	Disc/USB device
Video files <sup>1)2)</sup> only	Video files <sup>1)2)</sup>	Video files <sup>1)2)</sup>	Video files <sup>1)2)</sup>	Video files <sup>1)2)</sup>	Video files <sup>1)2)</sup>
JPEG image files only	JPEG image files	JPEG image files	JPEG image files	JPEG image files	JPEG image files
Audio files <sup>3)</sup> only	MP3 files	Audio files	MP3 files	Audio files <sup>3)</sup>	Audio files <sup>3)</sup>
Video files <sup>1)2)</sup> and JPEG image files	Video files <sup>1)2)</sup>	Video files <sup>1)2)</sup>	JPEG image files	JPEG image files	Video files <sup>1)2)</sup>
Video files <sup>1)2)</sup> and audio files <sup>3)</sup>	Video files <sup>1)2)</sup>	Video files <sup>1)2)</sup>	MP3 files	Audio files <sup>3)</sup>	Audio files <sup>3)</sup>
Audio files <sup>3)</sup> and JPEG image files	MP3 files and JPEG image files with slide show	Audio files	MP3 files and JPEG image files with slide show	JPEG image files	Audio files <sup>3)</sup>
Video files <sup>1)2)</sup> , audio files <sup>3)</sup> , and JPEG image files	Video files <sup>1)2)</sup>	Video files <sup>1)2)</sup>	MP3 files and JPEG image files with slide show	JPEG image files	Audio files <sup>3)</sup>

<sup>1)</sup>Except for North American models.

<sup>2)</sup>MPEG-4 files only playable on United Kingdom models.

<sup>3)</sup>When using a disc, you can play MP3 files only.

## Language Code List

The language spellings conform to the ISO 639: 1988 (E/F) standard.

Code	Language	Code	Language	Code	Language	Code	Language
1027	Afar	1183	Irish	1347	Maori	1507	Samoaan
1028	Abkhazian	1186	Scots Gaelic	1349	Macedonian	1508	Shona
1032	Afrikaans	1194	Galician	1350	Malayalam	1509	Somali
1039	Amharic	1196	Guarani	1352	Mongolian	1511	Albanian
1044	Arabic	1203	Gujarati	1353	Moldavian	1512	Serbian
1045	Assamese	1209	Hausa	1356	Marathi	1513	Siswati
1051	Aymara	1217	Hindi	1357	Malay	1514	Sesotho
1052	Azerbaijani	1226	Croatian	1358	Maltese	1515	Sundanese
1053	Bashkir	1229	Hungarian	1363	Burmese	1516	Swedish
1057	Byelorussian	1233	Armenian	1365	Nauru	1517	Swahili
1059	Bulgarian	1235	Interlingua	1369	Nepali	1521	Tamil
1060	Bihari	1239	Interlingue	1376	Dutch	1525	Telugu
1061	Bislama	1245	Inupiak	1379	Norwegian	1527	Tajik
1066	Bengali;	1248	Indonesian	1393	Occitan	1528	Thai
	Bangla	1253	Icelandic	1403	(Afan)Oromo	1529	Tigrinya
1067	Tibetan	1254	Italian	1408	Oriya	1531	Turkmen
1070	Breton	1257	Hebrew	1417	Punjabi	1532	Tagalog
1079	Catalan	1261	Japanese	1428	Polish	1534	Setswana
1093	Corsican	1269	Yiddish	1435	Pashto;	1535	Tonga
1097	Czech	1283	Javanese		Pushto	1538	Turkish
1103	Welsh	1287	Georgian	1436	Portuguese	1539	Tsonga
1105	Danish	1297	Kazakh	1463	Quechua	1540	Tatar
1109	German	1298	Greenlandic	1481	Rhaeto-	1543	Twì
1130	Bhutani	1299	Cambodian		Romance	1557	Ukrainian
1142	Greek	1300	Kannada	1482	Kirundi	1564	Urdu
1144	English	1301	Korean	1483	Romanian	1572	Uzbek
1145	Esperanto	1305	Kashmiri	1489	Russian	1581	Vietnamese
1149	Spanish	1307	Kurdish	1491	Kinyarwanda	1587	Volapük
1150	Estonian	1311	Kirghiz	1495	Sanskrit	1613	Wolof
1151	Basque	1313	Latin	1498	Sindhi	1632	Xhosa
1157	Persian	1326	Lingala	1501	Sangho	1665	Yoruba
1165	Finnish	1327	Laothian	1502	Serbo-	1684	Chinese
1166	Fiji	1332	Lithuanian		Croatian	1697	Zulu
1171	Faroese	1334	Latvian;	1503	Singhalese		
1174	French		Lettish	1505	Slovak		
1181	Frisian	1345	Malagasy	1506	Slovenian	1703	Not specified

## Parental Control Area Code List

Code	Area	Code	Area	Code	Area	Code	Area
2044	Argentina	2165	Finland	2362	Mexico	2149	Spain
2047	Australia	2174	France	2376	Netherlands	2499	Sweden
2046	Austria	2109	Germany	2390	New Zealand	2086	Switzerland
2057	Belgium	2248	India	2379	Norway	2528	Thailand
2070	Brazil	2238	Indonesia	2427	Pakistan	2184	United
2079	Canada	2254	Italy	2424	Philippines		Kingdom
2090	Chile	2276	Japan	2436	Portugal		
2092	China	2304	Korea	2489	Russia		
2115	Denmark	2363	Malaysia	2501	Singapore		



# Index

## A

A/V SYNC 59  
ANGLE 37  
ATTENUATE 60  
AUDIO 63  
AUDIO (HDMI) 64  
AUDIO DRC 66  
AUDIO RETURN CHANNEL 64  
AUDIO SETUP 65  
AUTO CALIBRATION 65  
AUTO STBY 61

## B

BACKGROUND 66

## C

CONTROL FOR HDMI 64  
Control for HDMI 51  
Control Menu 17  
CUSTOM 62

## D

D. C. A. C. (Digital Cinema  
Auto Calibration) 65  
DEMO 61  
DIMMER 61  
DivX® 9, 67  
DUAL MONO 60  
DVD's menu 38

## E

EFFECT 41

## F

FM MODE 46  
Front panel 12  
Front panel display 13

## H

HDMI  
YCBCR/RGB (HDMI) 64  
HDMI RESOLUTION 63  
HDMI SETUP 63

## I

INTERVAL 41  
iPod 44

## J

JPEG RESOLUTION 64

## L

Language Code List 80  
LANGUAGE SETUP 62  
LINE 63

## M

MEDIA 35, 41  
MENU 62  
Multi Session CD 8  
MULTI-DISC RESUME 67  
Multiplex broadcast sound 60

## O

OSD 62

## P

PAIRING 56  
PARENTAL CONTROL 66  
PAUSE MODE 63  
Playable discs 6  
Program Play 39

## Q

Quick Setup 30

## R

RDS 47  
Rear panel 14  
Region code 8  
Repeat Play 40  
RESET 67  
RF CHANGE 56

## S

S-AIR ID 54  
S-AIR MODE 55  
S-AIR receiver 53  
S-AIR STBY 55  
SCREEN SAVER 66  
SETUP 62  
Shuffle Play 40  
SLEEP 59  
SPEAKER FORMATION 65  
SPEAKER SETUP 67  
CONNECTION 67  
DISTANCE 68  
LEVEL 68  
SUBTITLE 37, 63  
Super Audio CD 38  
Surround amplifier 53  
SYSTEM MENU 46, 48, 54,  
55, 56, 59, 60, 61  
SYSTEM SETUP 66

## T

TEST TONE 68  
TIME 36  
TRACK SELECTION 66  
TV TYPE 63

## V

VIDEO SETUP 63  
VOLUME LIMIT 64







\* 4 1 6 5 4 8 1 1 1 \* (1)