



# Blu-ray Disc/DVD Home Theatre System

Operating Instructions

BDV-F7

## WARNING

**To reduce the risk of fire or electric shock, do not expose this apparatus to rain or moisture.**

Do not install the appliance in a confined space, such as a bookcase or built-in cabinet.

To reduce the risk of fire, do not cover the ventilation opening of the apparatus with newspapers, tablecloths, curtains, etc. Do not place the naked flame sources such as lighted candles on the apparatus. Do not expose batteries or apparatus with battery-installed to excessive heat such as sunshine, fire or the like.

To prevent injury, this apparatus must be securely attached to the floor/wall in accordance with the installation instructions. Indoor use only.

## CAUTION

The use of optical instruments with this product will increase eye hazard. As the laser beam used in this Blu-ray Disc / DVD Home Theatre System is harmful to eyes, do not attempt to disassemble the cabinet.

Refer servicing to qualified personnel only.



This appliance is classified as a CLASS 3R LASER product. Visible and invisible laser radiation is emitted when the laser protective housing is opened, so be sure to avoid direct eye exposure. This marking is located on the laser protective housing inside the enclosure.

CLASS 1 LASER PRODUCT  
LASER KLASSE 1  
LUOKAN 1 LASERLAITE  
KLASS 1 LASERAPPARAT  
1类激光产品

This appliance is classified as a CLASS 1 LASER product. The CLASS 1 LASER PRODUCT MARKING is located on the laser protective housing inside the enclosure.

## Precautions

### On power sources

- The unit is not disconnected from the mains as long as it is connected to the AC outlet, even if the unit itself has been turned off.
- As the main plug is used to disconnect the unit from the mains, connect the unit to an easily accessible AC outlet. Should you notice an abnormality in the unit, disconnect the main plug from the AC outlet immediately.

### On watching 3D video images

Some people may experience discomfort (such as eye strain, fatigue, or nausea) while watching 3D video images. Sony recommends that all viewers take regular breaks while watching 3D video images. The length and frequency of necessary breaks will vary from person to person. You must decide what works best. If you experience any discomfort, you should stop watching the 3D video images until the discomfort ends; consult a doctor if you believe necessary. You should also review (i) the instruction manual and/or the caution message of any other device used with, or Blu-ray Disc contents played with this product and (ii) our website (<http://esupport.sony.com/>) for the latest information. The vision of young children (especially those under six years old) is still under

development. Consult your doctor (such as a pediatrician or eye doctor) before allowing young children to watch 3D video images. Adults should supervise young children to ensure they follow the recommendations listed above.



This symbol is intended to alert the user to the presence of uninsulated “dangerous voltage” within the product’s enclosure that may be of sufficient magnitude to constitute a risk of electric shock to persons.



This symbol is intended to alert the user to the presence of important operating and maintenance (servicing) instructions in the literature accompanying the appliance.

### Owner's Record

The model and serial numbers are located at the rear exterior of the control unit. Record the serial number in the space provided below. Refer to them whenever you call upon your Sony dealer regarding this product.

Model No. BDV-F7

Serial No. \_\_\_\_\_

The following FCC statement applies only to the version of this model manufactured for sale in the U.S.A. Other versions may not comply with FCC technical regulations.

### NOTE:

This equipment has been tested and found to comply with the limits for a Class B digital device, pursuant to Part 15 of the FCC Rules. These limits are designed to provide reasonable protection against harmful interference in a residential installation. This equipment generates, uses, and can radiate radio frequency energy and, if not installed and used in accordance with the instructions, may cause harmful interference to radio

communications. However, there is no guarantee that interference will not occur in a particular installation. If this equipment does cause harmful interference to radio or television reception, which can be determined by turning the equipment off and on, the user is encouraged to try to correct the interference by one or more of the following measures:

- Reorient or relocate the receiving antenna (aerial).
- Increase the separation between the equipment and receiver.
- Connect the equipment into an outlet on a circuit different from that to which the receiver is connected.
- Consult the dealer or an experienced radio/TV technician for help.

## CAUTION

You are cautioned that any changes or modifications not expressly approved in this manual could void your authority to operate this equipment.

## Important Safety Instructions

- 1) Read these instructions.
- 2) Keep these instructions.
- 3) Heed all warnings.
- 4) Follow all instructions.
- 5) Do not use this apparatus near water.
- 6) Clean only with dry cloth.
- 7) Do not block any ventilation openings. Install in accordance with the manufacturer's instructions.
- 8) Do not install near any heat sources such as radiators, heat registers, stoves, or other apparatus (including amplifiers) that produce heat.
- 9) Do not defeat the safety purpose of the polarized or grounding-type plug. A polarized plug has two blades with one wider than the other. A grounding type plug has two

blades and a third grounding prong. The wide blade or the third prong are provided for your safety. If the provided plug does not fit into your outlet, consult an electrician for replacement of the obsolete outlet.

- 10) Protect the power cord from being walked on or pinched particularly at plugs, convenience receptacles, and the point where they exit from the apparatus.
- 11) Only use attachments/accessories specified by the manufacturer.
- 12) Use only with the cart, stand, tripod, bracket, or table specified by the manufacturer, or sold with the apparatus. When a cart is used, use caution when moving the cart/apparatus combination to avoid injury from tip-over.



- 13) Unplug this apparatus during lightning storms or when unused for long periods of time.
- 14) Refer all servicing to qualified service personnel. Servicing is required when the apparatus has been damaged in any way, such as power-supply cord or plug is damaged, liquid has been spilled or objects have fallen into the apparatus, the apparatus has been exposed to rain or moisture, does not operate normally, or has been dropped.

## For the USB Wireless LAN Adapter (UWA-BR100)

Pursuant to FCC regulations, you are cautioned that any changes or modifications not expressly approved in this manual could void your authority to operate this equipment.

To prevent radio interference to the licensed service, this device is intended to be operated indoors and away from windows to provide maximum shielding. Equipment (or its transmit antenna) that is installed outdoors is subject to licensing.

Only use Wireless LAN indoors when using it with IEEE 802.11a (5 GHz).

High power radars are allocated as primary users (meaning they have priority) of 5250-5350 MHz and 5650-5850 MHz and these radars could cause interference and/or damage to this device.

This device uses 5 GHz band for wireless LAN communication and the maximum gain of the antenna in this device is 5 dBi.

This equipment complies with FCC/IC radiation exposure limits set forth for an uncontrolled environment. This equipment should be installed and operated with minimum distance 20 cm between the radiator and your body (excluding extremities: hands, wrists and feet).

This device and its antenna(s) must not be co-located or operating with any other antenna or transmitter except Grant condition.

If you have any questions about this product, contact Sony Customer Information Service Center at 1-800-222-7669 or visit <http://www.sony.com/> on the Internet.

The telephone number below is for FCC-related matters only.

Regulatory Information

## Declaration of Conformity

Trade Name: SONY

Model: UWA-BR100

Responsible Party: Sony Electronics Inc.

Address: 16530 Via Esprillo, San Diego, CA 92127 U.S.A.

Telephone Number: 858-942-2230

This device complies with part 15 of the FCC rules. Operation is subject to the following two conditions: (1) This device may not cause harmful interference, and (2) this device must accept any interference received, including interference that may cause undesired operation.

## Copyrights and Trademarks

- This system incorporates with Dolby\* Digital and the DTS\*\* Digital Surround System.
  - \* Manufactured under license from Dolby Laboratories. Dolby and the double-D symbol are trademarks of Dolby Laboratories.
  - \*\* Manufactured under license under U.S. Patent #'s: 5,451,942; 5,956,674; 5,974,380; 5,978,762; 6,226,616; 6,487,535; 7,212,872; 7,333,929; 7,392,195; 7,272,567 & other U.S. and worldwide patents issued & pending. DTS and the Symbol are registered trademarks, & DTS-HD, DTS-HD Master Audio, and the DTS logos are trademarks of DTS, Inc. Product includes software. © DTS, Inc. All Rights Reserved.
- “AVCHD” and the “AVCHD” logo are trademarks of Matsushita Electric Industrial Co., Ltd. and Sony Corporation.
- Java and all Java-based trademarks and logos are

trademarks or registered trademarks of Sun Microsystems, Inc.

- “XMB,” and “xross media bar” are trademarks of Sony Corporation and Sony Computer Entertainment Inc.
- This system incorporates High-Definition Multimedia Interface (HDMI™) technology. HDMI, the HDMI logo and High-Definition Multimedia Interface are trademarks or registered trademarks of HDMI Licensing LLC.
- “Blu-ray Disc” is a trademark.
- “Blu-ray Disc,” “DVD+RW,” “DVD-RW,” “DVD+R,” “DVD-R,” “DVD VIDEO,” and “CD” logos are trademarks.
- “BD-LIVE” and “BONUSVIEW” are trademarks of Blu-ray Disc Association.
- “Blu-ray 3D” and “Blu-ray 3D” logo are trademarks of Blu-ray Disc Association.
- “BRAVIA” is a trademark of Sony Corporation.
- “PhotoTV HD” and the “PhotoTV HD” logo are trademarks of Sony Corporation.
- MPEG Layer-3 audio coding technology and patents licensed from Fraunhofer IIS and Thomson.
- Music and video recognition technology and related data are provided by Gracenote®. Gracenote is the industry standard in music recognition technology and related content delivery. For more information, please visit [www.gracenote.com](http://www.gracenote.com). CD, DVD, Blu-ray Disc, and music and video-related data from Gracenote, Inc., copyright © 2000-present Gracenote. Gracenote Software, copyright © 2000-present Gracenote. One or more patents owned by Gracenote apply to this product and service. See the Gracenote website for a nonexhaustive list of applicable Gracenote patents. Gracenote, CDDB, MusicID, MediaVOCS,

the Gracenote logo and logotype, and the “Powered by Gracenote” logo are either registered trademarks or trademarks of Gracenote in the United States and/or other countries.



- Windows Media is either a registered trademark or trademark of Microsoft Corporation in the United States and/or other countries.
- DLNA®, the DLNA Logo and DLNA CERTIFIED™ are trademarks, service marks, or certification marks of the Digital Living Network Alliance.
- iPod is a trademark of Apple Inc., registered in the U.S. and other countries.
- “Made for iPod” means that an electronic accessory has been designed to connect specifically to iPod and has been certified by the developer to meet Apple performance standards.
- Apple is not responsible for the operation of this device or its compliance with safety and regulatory standards.
- “PLAYSTATION” is a trademark of Sony Computer Entertainment Inc.
- Other system and product names are generally trademarks or registered trademarks of the manufacturers. ™ and ® marks are not indicated in this document.

---

# About These Operating Instructions

- The instructions in these Operating Instructions describe the controls on the remote. You can also use the controls on the unit if they have the same or similar names as those on the remote.
- In this manual, “disc” is used as a general reference for BDs, DVDs, Super Audio CDs, or CDs unless otherwise specified by the text or illustrations.
- The items displayed on the TV screen may vary depending on the area.
- The default setting is underlined.

---

# Table of Contents

About These Operating Instructions .....	5	[Screen Settings].....	50
Unpacking .....	7	[Audio Settings].....	51
Index to Parts and Control .....	8	[BD/DVD Viewing Settings] .....	52
<b>Getting Started</b>		[Parental Control Settings] .....	52
<b>Step 1: Installing the System</b> .....	14	[Music Settings].....	53
<b>Step 2: Connecting the System</b> ...	17	[System Settings].....	53
<b>Step 3: Connecting to the</b>		[Network Settings].....	54
<b>Network</b> .....	25	[Easy Setup].....	55
<b>Step 4: Performing the Easy</b>		[Resetting] .....	55
<b>Setup</b> .....	29	<b>Additional Information</b>	
<b>Step 5: Selecting the Source</b> .....	30	Precautions .....	56
<b>Step 6: Enjoying Surround</b>		Notes about the Discs .....	57
<b>Sound</b> .....	31	Troubleshooting .....	58
<b>Playback</b>		Playable Discs .....	64
Playing a Disc .....	33	Playable Types of Files .....	65
Playing from a USB Device.....	34	Supported Audio Formats.....	66
Enjoying an iPod.....	35	Specifications .....	67
Playing via a Network.....	35	Language Code List.....	69
Available Options .....	38	Glossary .....	70
<b>Sound Adjustment</b>		Index .....	72
Selecting the Effect to Suit the			
Source .....	40		
Selecting the Audio Format, Multilingual			
Tracks, or Channel.....	40		
Enjoying Multiplex Broadcast Sound ...	41		
<b>Tuner</b>			
Listening to the Radio .....	42		
<b>Other Operations</b>			
Using the Control for HDMI Function for			
“BRAVIA” Sync .....	44		
Setting the Speakers .....	46		
Using the Sleep Timer .....	47		
Changing the Illumination LED Lighting			
Type .....	47		
Deactivating the Buttons on the Unit ...	47		
Controlling Your TV with the Supplied			
Remote .....	48		
Saving Power in Standby Mode.....	48		
<b>Settings and Adjustments</b>			
Using the Setup Display.....	49		
[Network Update] .....	49		

# Unpacking

- Unit (1)

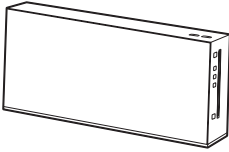

- Front speaker (1)



- Subwoofer (1)

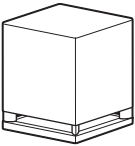

- USB Wireless LAN Adapter (UWA-BR100) (1)

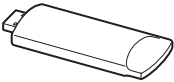

- UWA-BR100 External cable (1)

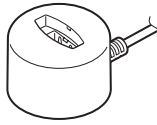

- Speaker cords (2, white/red, purple)



- Video cord (1)



- FM wire antenna (aerial) (1)

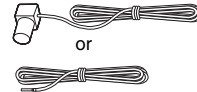

- Cable tie (1)



- Foot pad (1)



- Remote commander (remote) (1)



- R6 (size AA) batteries (2)



- Operating Instructions
- Quick Setup Guide
- End user license agreement

## Preparing the remote

Insert two R6 (size AA) batteries (supplied) by matching the ⊕ and ⊖ ends on the batteries to the markings inside the compartment.

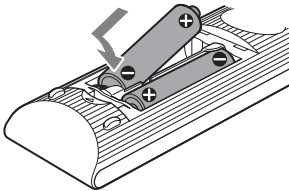

# Index to Parts and Control

For more information, refer to the pages indicated in parentheses.

## Unit

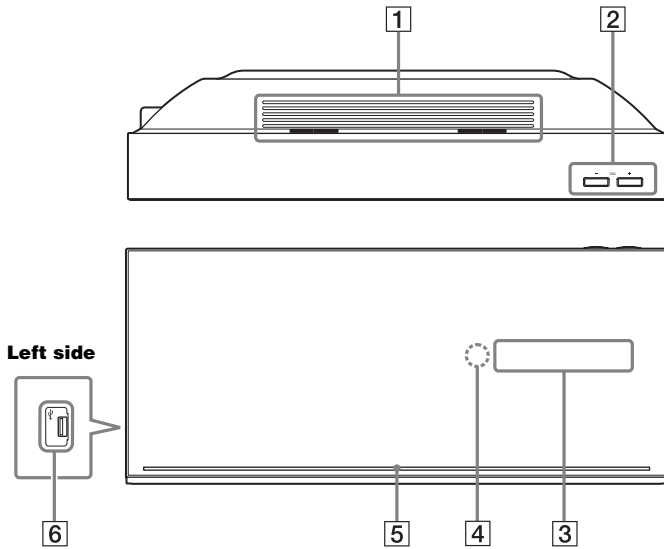

- 1** Ventilation slots
- 2** VOL (volume) +/-  
Adjusts the system's volume.
- 3** Front panel display
- 4**  (remote sensor)
- 5** Illumination LED (page 47)
- 6**  (USB) port (left) (page 34)  
Used for connecting a USB device.



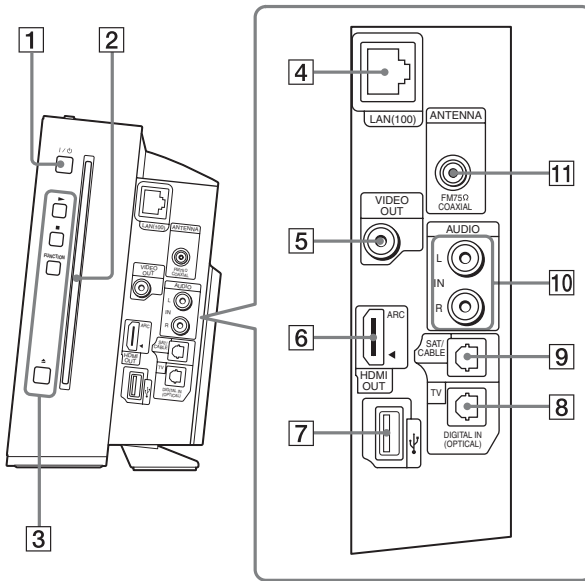

**1 I/⏻ (on/standby)**

Turns on the unit, or sets it to standby mode.

**2 Disc slot (page 33)**

**3 Play operation buttons**

**▶ (play)**

Starts or re-starts playback (resume play).  
Plays a slideshow when a disc containing JPEG image files is inserted.

**■ (stop)**

Stops playback and remembers the stop point (resume point).

The resume point for a title/track is the last point you played or the last photo for a photo folder.

**FUNCTION**

Selects the playback source.

**▲ (eject)**

Ejects the disc.

**4 LAN (100) terminal (page 25)**

**5 VIDEO OUT jack (page 21)**

**6 HDMI OUT jack (page 21)**

**7 ↔ (USB) port (right) (page 34)**

Used for connecting a USB device.

**8 TV (DIGITAL IN OPTICAL) jack (page 22)**

**9 SAT/CABLE (DIGITAL IN OPTICAL) jack (page 23)**

**10 AUDIO (IN L/R) jacks (page 23)**

**11 ANTENNA (FM 75Ω COAXIAL) jack (page 24)**

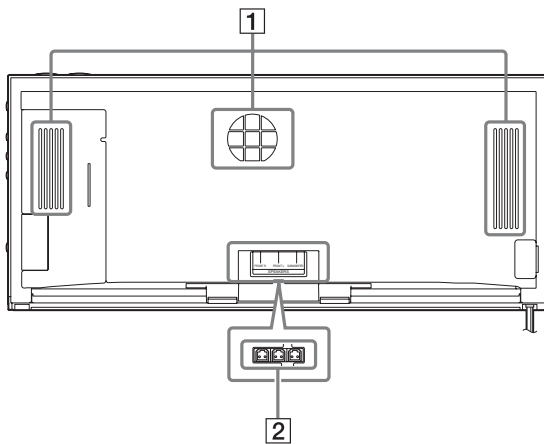

**1** Ventilation slots

**2** SPEAKERS jacks (page 18)

## Front panel display

### About the indications in the front panel display

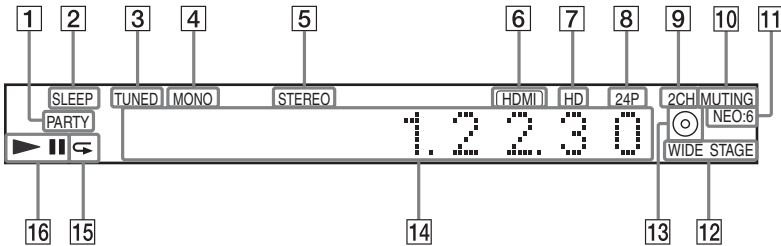

- 1 Lights up when the system is playing via the PARTY STREAMING function.
- 2 Flashes when the sleep timer is set. (page 47)
- 3 Lights up when a station is received. (Radio only) (page 42)
- 4 Lights up when “FM MODE” is set to “MONO.” (Radio only) (page 42)
- 5 Lights up when stereo sound is received. (Radio only) (page 42)
- 6 Lights up when the HDMI OUT jack is correctly connected to an HDCP (High-bandwidth Digital Content Protection)-compliant device with HDMI or DVI (Digital Visual Interface) input.
- 7 Lights up when outputting 720p/1080i/1080p video signals from the HDMI OUT jack.
- 8 Lights up when outputting 1920 x 1080p/24 Hz video signals.
- 9 Lights up during playback with “2CH STEREO.”
- 10 Lights up when the sound of the system is muted.
- 11 Lights up when outputting DTS Neo:6 mode sound.
- 12 Lights up during playback with “WIDE STAGE” surround sound effect.
- 13 Lights up when a disc is loaded.
- 14 Displays system’s status such as chapter, title, or track number, time information, radio frequency, playing status, etc.
- 15 Lights up when repeat play is activated.
- 16 Displays system’s playing status.

## Remote control

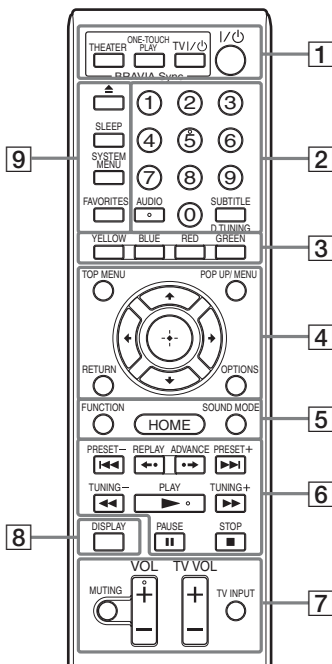

Number 5, AUDIO, VOL +, and ► buttons have a tactile dot. Use the tactile dot as a reference when operating the remote.

- **TV** : For TV operations  
(For details, see “Controlling Your TV with the Supplied Remote” (page 48).)

### 1 THEATER (page 45) **TV**

Switches to the optimum video mode for watching movies automatically.

### ONE-TOUCH PLAY (page 45)

Activates One-Touch Play.

### TV I/O (on/standby) (page 48) **TV**

Turns on the TV or sets it to standby mode.

### I/O (on/standby) (pages 29, 42)

Turns on the system or sets it to standby mode.

### 2 Number buttons (pages 43, 48)

Enters the title/chapter numbers, radio frequencies, etc.

### AUDIO (pages 40, 41)

Selects the audio format/track.

### SUBTITLE (page 52)

Selects the subtitle language when multilingual subtitles are recorded on a BD-ROM/DVD VIDEO.

### D.TUNING (direct tuning) (page 42)

Selects the radio frequencies.

### 3 Color buttons (YELLOW/BLUE/RED/ GREEN)

Short cut keys for selecting items on some BD menus (can also be used for Java interactive operations on BDs).

### 4 TOP MENU

Opens or closes the BD's or DVD's Top Menu on the TV screen.

### POP UP/MENU

Opens or closes the BD-ROM's Pop-up Menu, or the DVD's menu.

### OPTIONS (page 38)

Displays the options menu on the TV screen.

### RETURN

Returns to the previous display.

◀/▶/◂/▸

Moves the highlight to a displayed item.

### ⊕ (ENTER)

Enters the selected item.

### 5 FUNCTION (pages 30, 42)

Selects the playback source.

### HOME (pages 29, 42, 46, 49)

Enters or exits the system's home menu on the TV screen.

### SOUND MODE (page 40)

Selects the sound mode.

### 6 Playback operation buttons

See “Playback” (page 33).

### ◀◀/▶▶ (previous/next)

Skip to the previous/next chapter, track, or file.

### ◀◂/◃▶ (replay/advance)

Briefly replay the current scenes for 10 seconds. / Briefly fast forwards the current scenes for 15 seconds.

**◀◀/▶▶ (fast reverse/fast forward)**

Fast reverse/fast forward the disc during playback. Each time you press the button, search speed changes.

Activates slow-motion play when pressed for more than one second in pause mode. Plays one frame at a time when pressed in pause mode.

**▶ (play)**

Starts or re-starts playback (resume play). Plays a slideshow when a disc containing JPEG image files is inserted.

**⏸ (pause)**

Pauses or re-starts playback.

**■ (stop)**

Stops playback and remembers the stop point (resume point). The resume point for a title/track is the last point you played or the last photo for a photo folder.

**Radio operation buttons**

See “Tuner” (page 42).

**PRESET +/-**

**TUNING +/-**

**7 MUTING**

Turns off the sound temporarily.

**VOL +/- (page 42)**

Adjusts the volume.

**TV VOL +/-**  TV

Adjusts the TV volume.

**TV INPUT**  TV

Switches the TV's input source between the TV and other input sources.

**8 DISPLAY (pages 33, 35)**

Displays the playback information on the TV screen.

When the function is “TV” or “SAT/CABLE” and digital signals are input via the TV (DIGITAL IN OPTICAL) or SAT/CABLE (DIGITAL IN OPTICAL) jack, displays the stream information in the front panel display.

**9 ▲ (eject)**

Ejects the disc.

**SLEEP (page 47)**

Sets the sleep timer.

**SYSTEM MENU (pages 31, 39, 42, 47)**

Enters or exits the system menu in the front panel display.

**FAVORITES**

Displays the Internet contents added to the Favorites List. You can save 18 favorite Internet contents.

## Step 1: Installing the System

### Positioning the speakers

Position the system as illustrated below.

#### When installing the front speaker on a TV stand

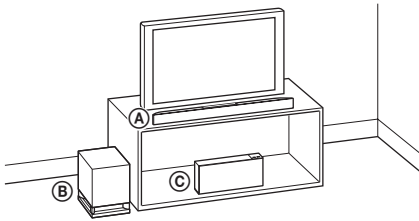

- Ⓐ Front speaker
- Ⓑ Subwoofer
- Ⓒ Unit

#### When installing the front speaker on a wall

For details, see “To install the front speaker on a wall” (page 15).

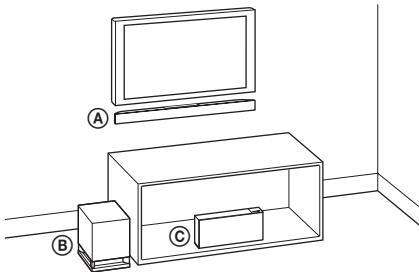

- Ⓐ Front speaker
- Ⓑ Subwoofer
- Ⓒ Unit

#### Note

- Place the subwoofer on a flat and firm floor (not on thick pile carpet, for example).
- Leave a space for inserting/ejecting the disc (approximately 6 inches (15 cm)) to the right (disc slot) side of the unit when placing an object nearby.

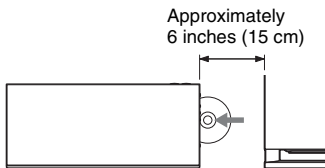

- Use caution when placing the speakers on a specially treated (waxed, oiled, polished, etc.) floor, as staining or discoloration may result.
- Image distortion on the TV screen may occur depending on the location of the subwoofer. In this case, place the subwoofer away from the TV.

- Do not block the ventilation slots of the unit (page 8).
- Place the front speaker forward from the TV. Make sure there are no reflecting obstacles in front of the speaker.
- The front speaker should be pointed straight forward. Do not place the speaker at an angle.

## To install the front speaker on a wall

### Caution

- Contact a screw shop or installer regarding the wall material or screws to be used.
- Use screws that are suitable for the wall material and strength. As a plaster board wall is especially fragile, attach the screws securely to a beam and fasten them to the wall. Install the speaker on a vertical and flat wall where reinforcement is applied.
- Be sure to subcontract the installation to Sony dealers or licensed contractors and pay special attention to safety during the installation.
- Sony is not responsible for accidents or damage caused by improper installation, insufficient wall strength or improper screw installation, natural calamity, etc.

### 1 Connect the speaker cord to the front speaker.

For details, see “To connect the speaker cord to the front speaker” (page 18).

### 2 Prepare screws (not supplied) that are suitable for the holes on the back of the speaker. See the illustrations below.

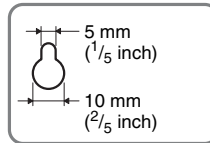
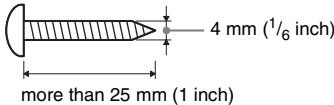

Hole on the back of the speaker

#### Note

- The length and type of the screw are examples. Select screws in accordance with the material or strength of the wall to which you install the speaker.

### 3 Fasten the screws to the wall. The screws should protrude 6 to 7 mm (approx. $\frac{1}{4}$ inch).

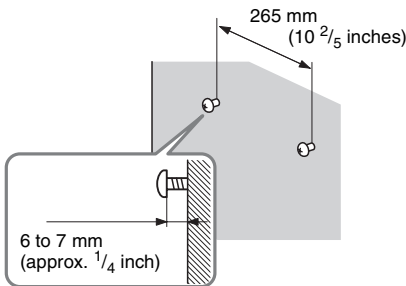

### 4 Hang the speaker onto the screws.

Align the holes on the back of the speaker to the screws, then hang the speaker onto the two screws.

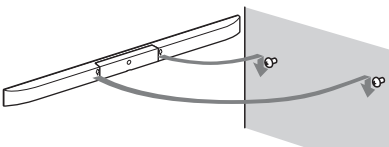

**Note**

- Be careful not to pinch the speaker cord while tightening the screws.





## Step 2: Connecting the System

For connecting the system, read the information on the following pages.

Do not connect the AC power cord (mains lead) of the unit to a wall outlet (mains) until all the other connections are made.

**Note**

- When you connect another component with a volume control, turn down the volume of the other components to a level where sound is not distorted.

### To remove the panel cover of the unit

Before connecting the cables, remove the panel cover from the unit.

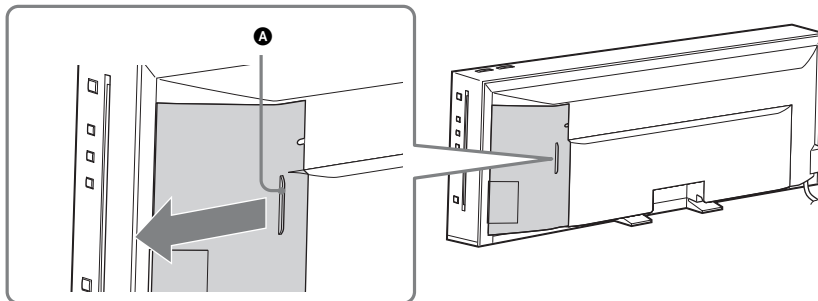

Hold the panel cover at (A), then slide it out to the side.

**Note**

- Before using the unit, remove the seal attached at the lower rear of the unit.

## Connecting the speakers

The connectors of the speaker cords are color-coded depending on the type of speaker. Connect the speaker cords to match the color of the SPEAKERS jacks of the unit.

### To connect speaker cords to the unit

Fully insert the speaker cord connectors into the unit.

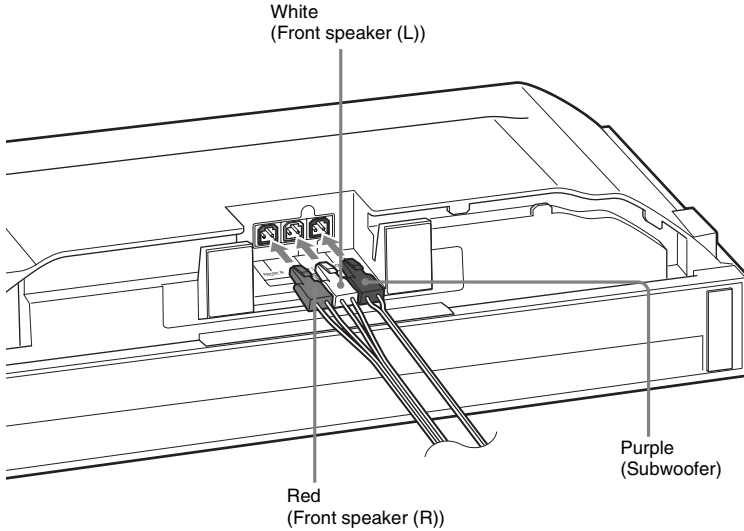

#### Note

- Make sure to place the unit on a soft thick cloth to prevent damaging the unit.

### To connect the speaker cord to the front speaker

- 1 Remove the screw of the cover at the rear of the speaker, and then remove the cover.

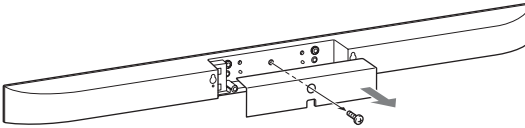

#### Note

- The cover is attached to the speaker sturdily to prevent it from falling down or dropping off. Firmly remove it.

## 2 Connect the speaker cord.

The connector of the speaker cord is color-coded depending on the speaker channel. Connect the connector of the speaker cord to match the color of the speaker jack.

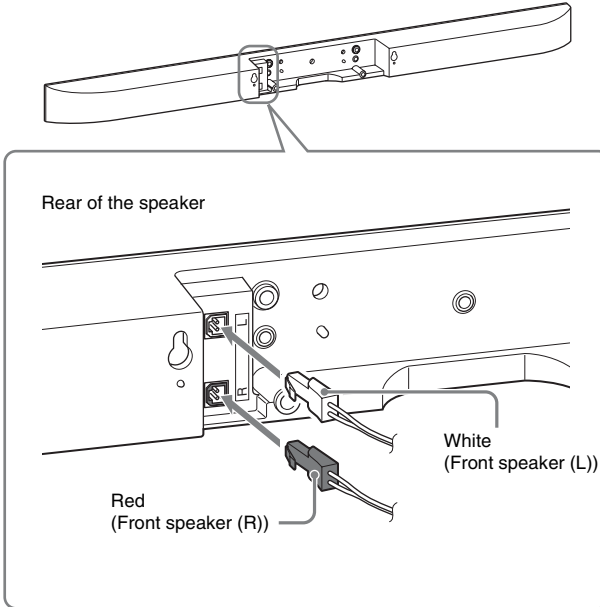

## 3 Guide the speaker cord through the square notch at the bottom of the cover, and then reattach the cover to the speaker and secure it with the screw removed in Step 1.

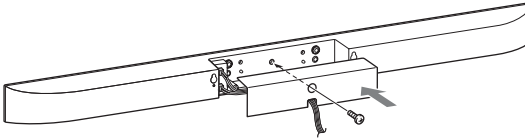

## To install the front speaker at an upward angle

The front speaker can be tilted upward by attaching the foot pad. This is useful for projecting the sound upward when installing the front speaker on a low rack or low TV stand, etc.

Bottom of the speaker

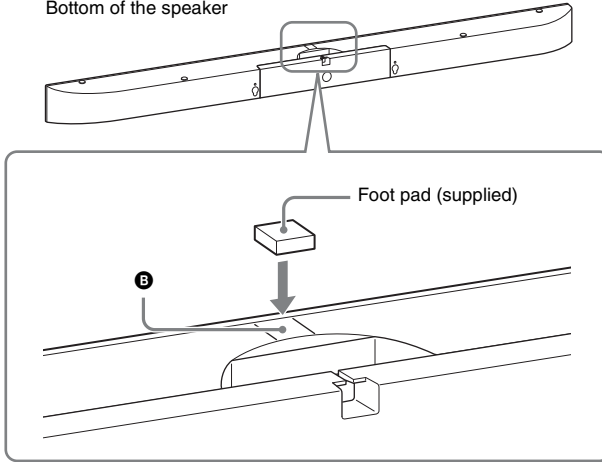

Attach the foot pad (supplied) to the bottom of the speaker by removing the protective cover and aligning the foot pad with the mark (B).

## To connect the speaker cord to the subwoofer

### 1 Connect the speaker cord to the subwoofer.

Be sure to match the speaker cord to the appropriate terminal on the subwoofer: the speaker cord with the color tube to  $\oplus$ , and the speaker cord without the color tube to  $\ominus$ . Do not catch the speaker cord insulation (rubber covering) in the speaker terminals.

Bottom of the subwoofer

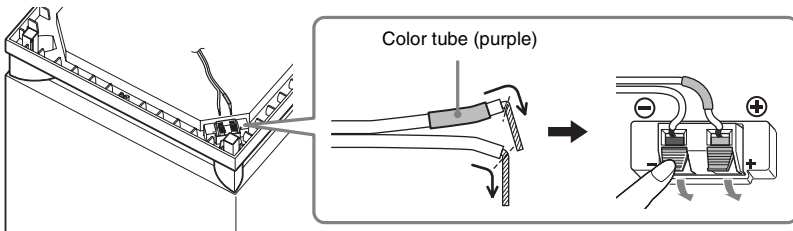

### 2 Thread the speaker cord through the gap along the side of the subwoofer, and secure it in the speaker cord holder.

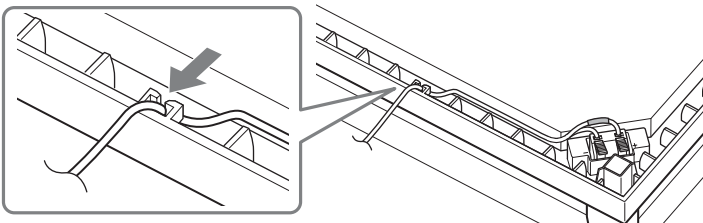

## Connecting the TV (Video connection)

This connection sends a video signal to the TV.

Depending on the jacks on your TV, select the connection method.

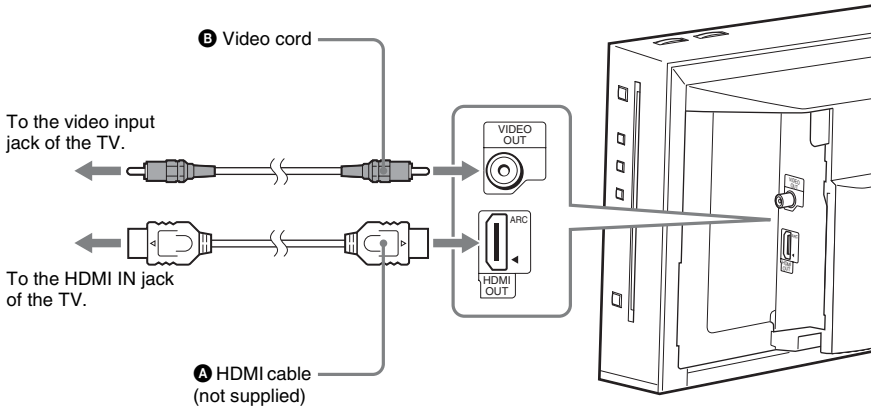

### Method 1: HDMI cable (A) connection

If your TV has an HDMI jack, connect to the TV with an HDMI cable. Picture quality will be improved compared to using the video cord connection.

When connecting with the HDMI cable, you need to select the type of output signal (pages 50).

### Method 2: Video cord (B) connection

If you do not have an HDMI cable, temporarily make this connection.

## Connecting the TV (Audio connection)

This connection sends an audio signal to the unit from the TV. To listen to TV sound via the system, perform this connection.

With a digital audio connection, the system receives a Dolby Digital multiplex broadcast signal and you can enjoy multiplex broadcast sound.

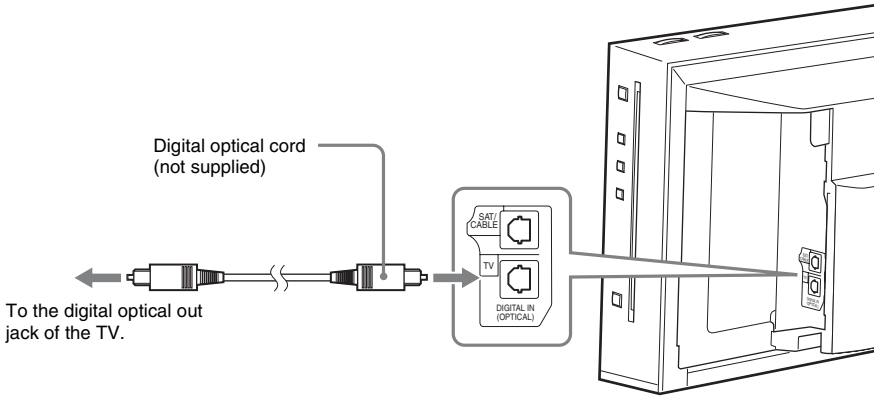

To the digital optical out jack of the TV.

### About Audio Return Channel (ARC)

If your TV is compatible with the Audio Return Channel function, an HDMI cable connection also sends a digital audio signal from the TV. You do not need to make a separate audio connection for listening to TV sound. For details of the Audio Return Channel function, see [Audio Return Channel] (page 53).

## Connecting the other components

When you connect the system and other components to the TV, video signals from the system and the components are sent to the TV, and audio signals from the components are sent to the system as follows.

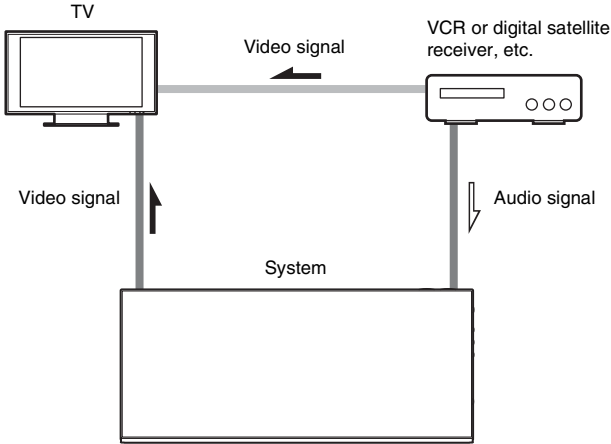

You can enjoy connected components via the system's speakers.

- VCR or digital satellite receiver, etc. (not supplied), which has a digital optical output jack: **C**
- VCR, digital satellite receiver, PlayStation, or portable audio source, etc. (not supplied): **D**

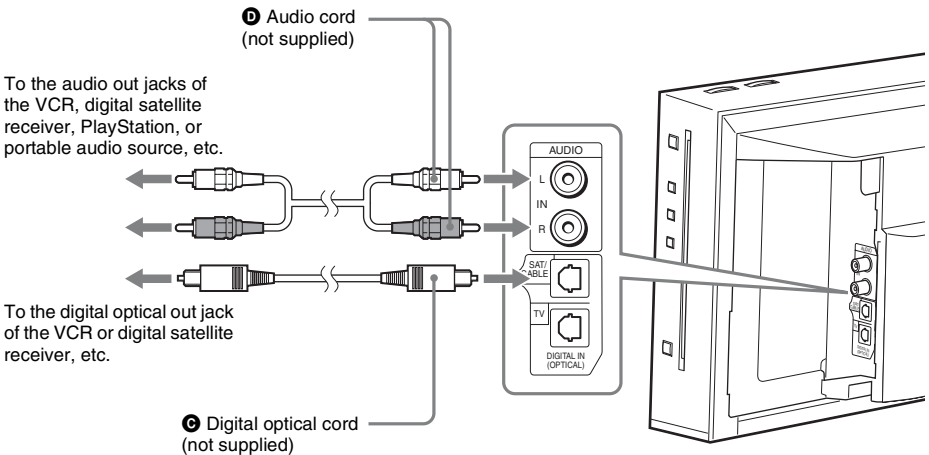

## Connecting the antenna (aerial)

### To connect the antenna (aerial)

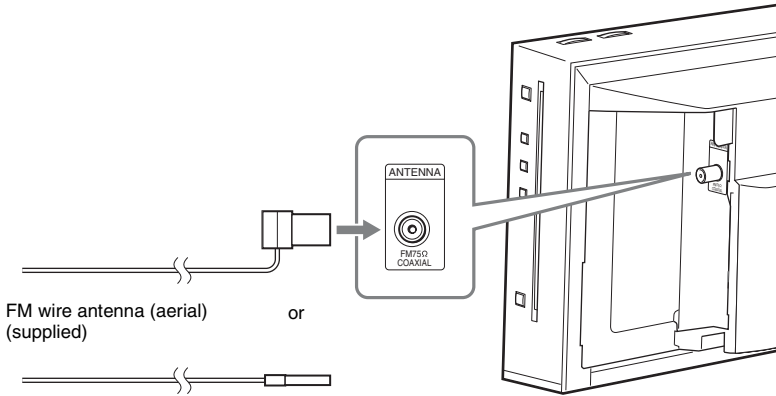

#### Tip

- If you have poor FM reception, use a 75-ohm coaxial cable (not supplied) to connect the unit to an outdoor FM antenna (aerial) as shown below.

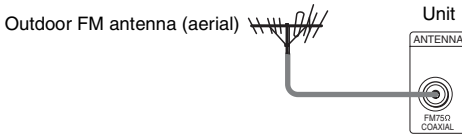



## Step 3: Connecting to the Network

Connecting the system to the Internet allows you to watch Internet video, listen to Internet audio, use BD-LIVE, and update the Home Theatre System software.

### Wired Setup

Use a LAN cable to connect to the LAN (100) terminal on the unit.

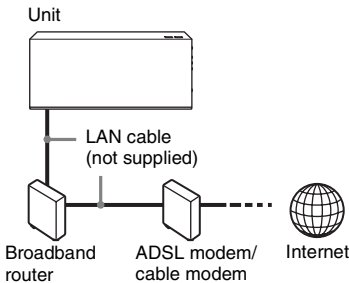

#### Tip

- Using a shielded LAN cable, straight or crossing, is recommended.

### To set the network settings

Select [Network Settings], [Internet Settings], then [Wired Setup] (page 54), and follow the on-screen instructions to complete the setup.

### USB Wireless Setup

Use a wireless LAN via the USB Wireless LAN Adapter (Sony UWA-BR100 only).

Turn off the unit before connecting the extension cable or inserting the USB Wireless LAN Adapter. After inserting the USB Wireless LAN Adapter to the base of the extension cable and connecting the extension cable to the  (USB) port (left or right), turn on the unit again.

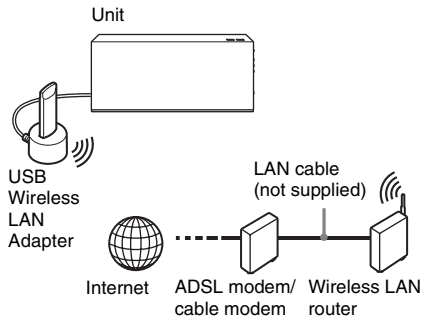

#### Note

- The placement distance between the USB Wireless LAN Adapter and your wireless LAN router differs depending on the usage environment. If the system cannot connect to the network or the network connection is unstable, move the USB Wireless LAN Adapter to a different position or place the USB Wireless LAN Adapter and the wireless LAN router closer to each other.

### To set the network settings

Select [Network Settings], [Internet Settings], then [USB Wireless Setup] (page 54), and follow the on-screen instructions to complete the setup.

#### Tip

- For details on wireless network setup, please visit: <http://www.sony.com/blurayhtsupport>

### About wireless LAN security

Since communication via the wireless LAN function is established by radio waves, the wireless signal may be susceptible to interception. To protect wireless communication, this system supports various security functions. Be sure to correctly configure the security settings in accordance with your network environment.

#### No Security

Although you can easily make settings, anyone can intercept wireless communication or intrude into your wireless network, even without any sophisticated tools. Keep in mind that there is a risk of unauthorized access or interception of data.

**WEP**

WEP applies security to communications to prevent outsiders from intercepting communications or intruding into your wireless network. WEP is a legacy security technology that enables older devices, which do not support TKIP/AES, to be connected.

**WPA-PSK (TKIP), WPA2-PSK (TKIP)**

TKIP is a security technology developed to correct for the deficiencies of WEP. TKIP assures a higher security level than WEP.

**WPA-PSK (AES), WPA2-PSK (AES)**

AES is a security technology that uses an advanced security method that is distinct from WEP and TKIP.

AES assures a higher security level than WEP or TKIP.

## Attaching the panel cover

After connecting the cables, organize them and attach the panel cover by following the Steps below.

- 1 Place the unit on its face.

**Note**

- Make sure to place the unit on a soft thick cloth to prevent damaging the unit.

- 2 Bring together the cables (except the FM wire antenna (aerial)), thread them through the gap on the bottom of the unit, and then draw them around the rear support (A).

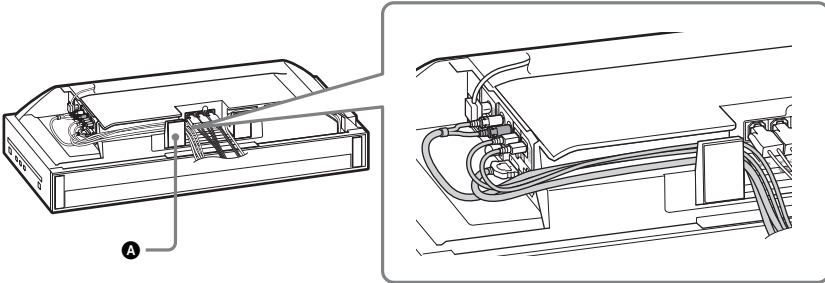

- 3 Thread the AC power cord (mains lead) through the gap on the bottom of the unit by securing it behind the tabs, and then draw it around the rear support (B).

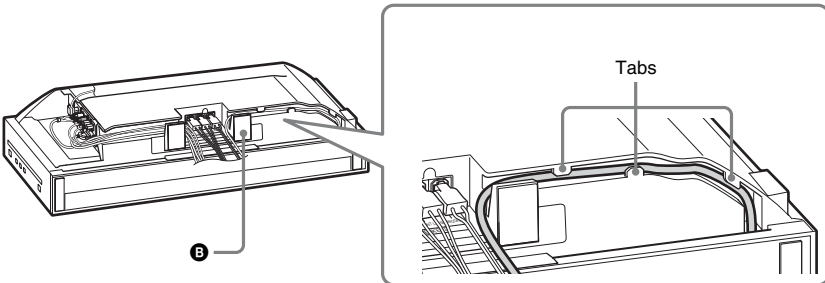

- 4 Bundle the cables and the speaker cords with the cable tie.

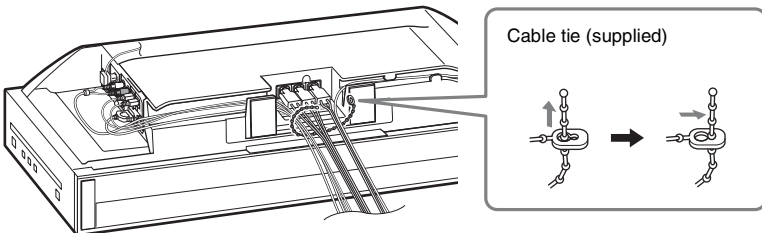

## 5 Attach the panel cover to the rear of the unit.

Put the corner of the panel cover on (C), then slide it inward until it clicks into place. Thread the FM wire antenna (aerial) through the small indentation of the panel cover.

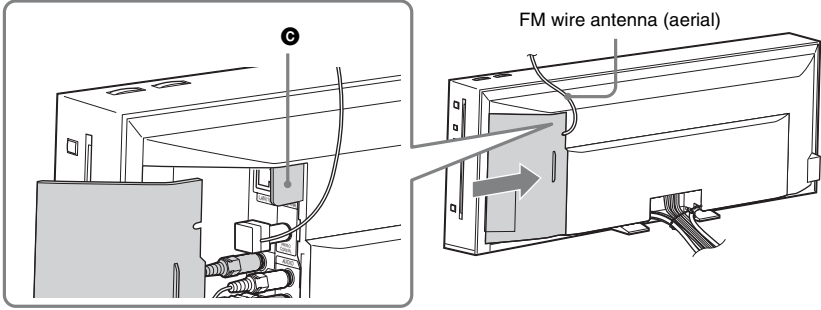

### Note

- Be sure to fully extend the FM wire antenna (aerial).
- After attaching the panel cover, keep the FM wire antenna (aerial) as horizontal as possible.

## To open the hatch of the panel cover

If you connect a USB device (such as a USB memory) that has a long body to the side panel, open the hatch of the panel cover before you attach the panel cover. Be sure not to lose the hatch.

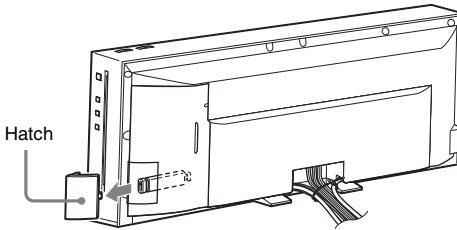

To open the hatch, remove the panel cover, hold the hatch, and then pull it up and outward.

To close the hatch, align the projection of the hatch with the projection opening on the panel cover, and then gently push in and down on the hatch until it clicks.

To open the hatch

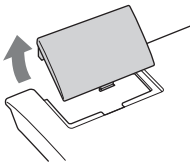

To close the hatch

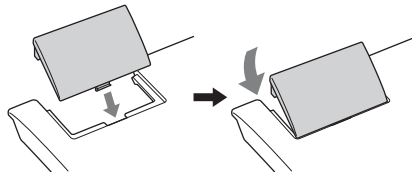

## Step 4: Performing the Easy Setup

### Before performing Step 4

Make sure all connections are secure, and then connect the AC power cord (mains lead). Follow the Steps below to make the basic adjustments for using the system.

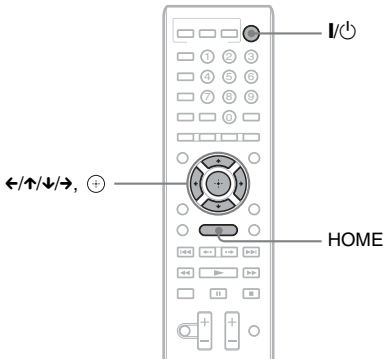

### To recall the Easy Setup Display

- 1** Press HOME.  
The home menu appears on the TV screen.
- 2** Press ←/→ to select  [Setup].
- 3** Press ↑/↓ to select [Easy Setup], then press ⊕.
- 4** Press ←/→ to select [Start], then press ⊕.  
The Easy Setup Display appears.

- 1** Turn on the TV.
- 2** Press I/Power on the unit.
- 3** Switch the input selector on your TV so that the signal from the system appears on the TV screen.

The Easy Setup Display for OSD language selection appears.

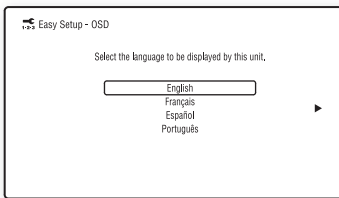

- 4** Perform the [Easy Setup]. Follow the on-screen instructions to make the basic settings using ←/↑/↓/→, and ⊕.

## Step 5: Selecting the Source

You can select the playback source.

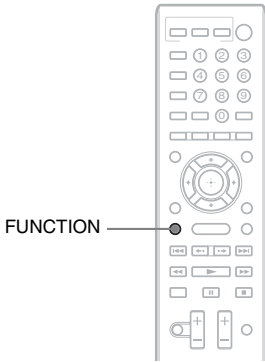

**Press FUNCTION repeatedly until the desired function appears in the front panel display.**

Each time you press FUNCTION, the function changes as follows.

“BD/DVD” → “D. MEDIA” → “TUNER FM”  
 → “TV” → “SAT/CABLE” → “AUDIO” →  
 “BD/DVD” → ...

Function	Source
“BD/DVD”	Disc that is played by the system
“D. MEDIA”	USB device, iPod, or BRAVIA Internet Video
“TUNER FM”	FM radio (page 42)
“TV”	Component (TV, etc.) that is connected to the TV (DIGITAL IN OPTICAL) jack on the side panel, or a TV compatible with the Audio Return Channel function that is connected to the HDMI OUT jack on the side panel (page 22).
“SAT/CABLE”	Component that is connected to the SAT/CABLE (DIGITAL IN OPTICAL) jack on the side panel (page 23)
“AUDIO”	Component that is connected to the AUDIO (IN L/R) jacks on the side panel (page 23)

## Step 6: Enjoying Surround Sound

After performing the previous Steps and starting playback, you can easily enjoy surround sound. Surround sound brings the exciting and powerful sound of movie theaters into your home.

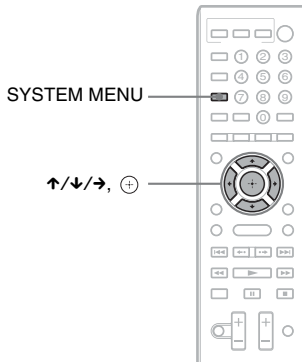

### Selecting surround settings based on your listening preference

- 1** Press **SYSTEM MENU**.
- 2** Press **↑/↓** repeatedly until “**SUR.SETTING**” appears in the front panel display, then press **⊕** or **→**.
- 3** Press **↑/↓** repeatedly until the surround setting you want appears in the front panel display.  
See the table below for surround sound setting descriptions.
- 4** Press **⊕**.  
The setting is made.
- 5** Press **SYSTEM MENU**.  
The system menu turns off.

#### About speaker output

The default setting is “**AUTO**.”

Surround setting	Effect
“ <b>AUTO</b> ”	The system outputs the sound with suitable effect automatically depending on the source. <ul style="list-style-type: none"> <li>• 2 channel source: Outputs 2 channel sound as it is.</li> <li>• Multi-channel source: Simulates 7.1 or 5.1 surround sound. The <b>WIDE STAGE</b> indicator on the front panel display lights up.</li> </ul>
“ <b>2CH STEREO</b> ”	The system outputs 2 channel sound regardless of sound format or number of channels. Multi-channel surround formats are downmixed to 2 channels.

#### To turn the surround sound effect off

Select “**2CH STEREO**” for “**SUR.SETTING**.”

**Note**

- Depending on the input stream, the surround settings may not be effective.
- When you play a Super Audio CD, surround settings are not activated.

**Tip**

- The system memorizes the last surround setting selected for each function. Whenever you select a function such as “BD/DVD” or “TUNER FM,” the surround setting that was last applied to the function is automatically applied again. For example, if you select “BD/DVD” with “AUTO” as the surround setting, then change to another function, and then return to “BD/DVD,” “AUTO” will be applied again.



## Playing a Disc

For playable discs, see “Playable Discs” (page 64).

**1 Switch the input selector on your TV so that the signal from the system appears on your TV screen.**

**2 Load a disc.**

Push the disc into the disc slot until the disc is pulled in automatically.

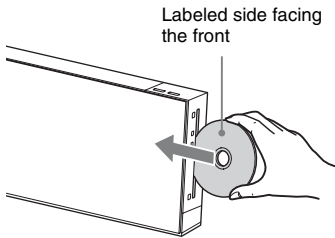

● appears on the home menu and playback starts.

If playback does not start automatically, select ● in the [Video], [Music], or [Photo] category, and press +.

**Note**

- Do not load a disc while the unit is in standby mode.
- Do not load a disc while the illumination LED is flashing just after you turn on the unit.
- Insert the disc straight into the disc slot.

## Enjoying BONUSVIEW/BD-LIVE

Some BD-ROMs with “BD-LIVE” logo\* have bonus content and other data that can be downloaded for enjoyment.

\* BD-LIVE™

**1 Prepare for BONUSVIEW/BD-LIVE.**

- Connect the unit to a network (page 25).
- Set [BD Internet Connection] to [Allow] (page 52).

**2 Insert a BD-ROM with BONUSVIEW/BD-LIVE.**

The operation method differs depending on the disc. Refer to the operating instructions of the disc.

**Tip**

- Delete unnecessary data in internal memory or USB memory. Select [Erase BD Data] in [Video] to delete unnecessary data. If you use USB memory as local storage, all saved data in the [BUDA/BUDB] folder is deleted. Make sure to backup any video/music/photo data in the [BUDA/BUDB] folder.

## Enjoying Blu-ray 3D

You can enjoy Blu-ray 3D Discs with the 3D logo\*.



**1 Prepare for Blu-ray 3D Disc playback.**

- Connect the system to your 3D-compatible TV using a High-Speed HDMI cable (not supplied).
- Set [3D Output Setting] and [TV Screen Size Setting for 3D] in [Screen Settings] (page 50).

**2 Insert a Blu-ray 3D Disc.**

The operation method differs depending on the disc. Refer to the operating instructions supplied with the disc.

**Tip**

- Refer also to the operating instructions of your 3D-compatible TV.

## Displaying the play information

You can check the playback information, etc., by pressing DISPLAY.

The displayed information differs depending on the disc type and player status.

Example: when playing a BD-ROM

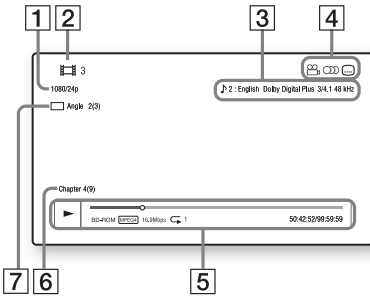

- 1 Output resolution/Video frequency
- 2 Title number or name
- 3 The currently selected audio setting
- 4 Available functions (angle, audio, subtitle)
- 5 Playback information  
Displays disc type, play mode, repeat status, video codec, bit rate, playing status bar, playing time, total time
- 6 Chapter number
- 7 The currently selected angle

## Playing from a USB Device

You can play video/music/photo files on the connected USB device.

For playable types of files, see “Playable Types of Files” (page 65).

### 1 Connect the USB device to a USB port on the unit.

Refer to the operating instructions of the USB device before connecting.

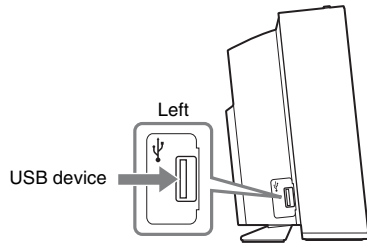
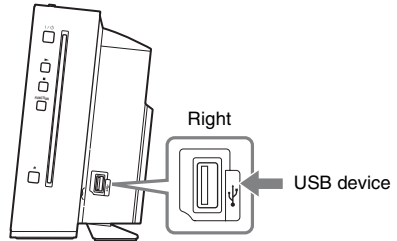

### 2 Press $\leftarrow/\rightarrow$ to select [Video], [Music], or [Photo].

### 3 Press $\uparrow/\downarrow$ to select [USB device (left)] or [USB device (right)], then press $\oplus$ .

#### Note

- Do not remove the USB device during operation. To avoid data corruption or damage to the USB device, turn the system off when connecting or removing the USB device.

# Enjoying an iPod

You can enjoy the sound and charge the battery of an iPod via the system.

## Compatible iPod models

The compatible iPod models are as follows. Update your iPod with the latest software before using with the system.

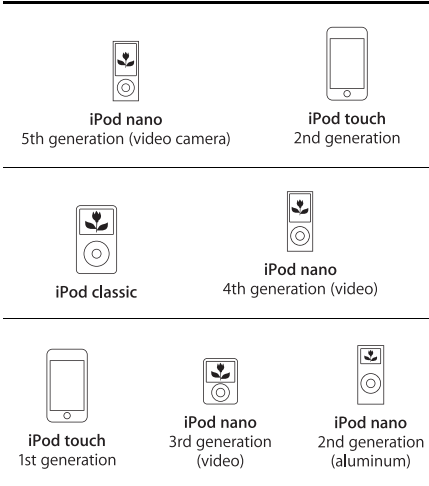

Press	Operation
	Same operation as the  button of the iPod.
	Pause.
	Fast reverse or forward.
	Same operation as the  buttons of the iPod.
DISPLAY, RETURN,	Same operation as the MENU button of the iPod.
	Same operation as the Click Wheel of the iPod.
	Same operation as the Center button of the iPod.

**Note**

- The iPod is charged when connected to the system while the system is turned on.
- You cannot transfer songs onto the iPod.
- Sony cannot accept responsibility in the event that data recorded to iPod is lost or damaged when using an iPod connected to this unit.
- This product has been designed specifically to work with iPod and has been certified to meet Apple performance standards.
- Do not remove the iPod during operation. To avoid data corruption or damage to the iPod, turn the system off when connecting or removing the iPod.

- 1** Connect the iPod to a (USB) port on the unit with the iPod's USB cable.
- 2** Press to select [Music].
- 3** Press to select [iPod (left)] or [iPod (right)], then press .

The sound from the iPod is played on the system.

You can operate the iPod using the buttons on the remote.

For operation details, refer to the operating instructions of the iPod.

## To operate the iPod using the remote

You can operate the iPod using the buttons on the remote. The following table shows an example of buttons that can be used.

# Playing via a Network

## Streaming BRAVIA Internet Video

BRAVIA Internet Video serves as a gateway delivering the selected Internet content and a variety of on-demand entertainment straight to your unit.

- 1** Prepare for BRAVIA Internet Video. Connect the unit to a network (page 25).
- 2** Press to select [Video], [Music], or [Photo].

### 3 Press $\uparrow/\downarrow$ to select an Internet content provider icon, then press $\oplus$ .

When the Internet content list has not been retrieved, it will be represented by an unacquired icon or a new icon.

### To use the control panel

The control panel appears when the video file starts playing. The displayed items may differ depending on Internet content providers.

To display again, press DISPLAY.

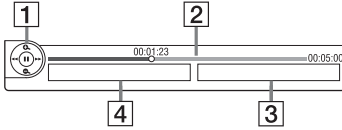

- 1 Control display  
Press  $\leftarrow/\rightarrow/\uparrow/\downarrow$  or  $\oplus$  for playback operations.
- 2 Playing status bar  
Status bar, cursor indicating the current position, playing time, duration of the video file
- 3 The next video file name
- 4 The currently selected video file name and rating

## Playing files stored on a DLNA server (DLNA Player)

You can play video/music/photo files on your home server, such as a DLNA-certified network audio system or a PC with software that enables a DLNA-certified server function, by connecting the system to your home network.

- 1 **Prepare for playing files on a DLNA server.**
  - Connect the unit to a network (page 25).
  - Set [Connection Server Settings] (page 54).
- 2 Press  $\leftarrow/\rightarrow$  to select  $\text{[Video]}$ ,  $\text{[Music]}$ , or  $\text{[Photo]}$ .
- 3 Press  $\uparrow/\downarrow$  to select a DLNA server, then press  $\oplus$ .  
The file list or folder list appears.

## Playing the same audio in different rooms (PARTY STREAMING)

### Note

- If [Party Auto Start] (page 55) is not displayed on the TV screen, this function may be available via a future update. However, the function may not be available in some regions/countries.

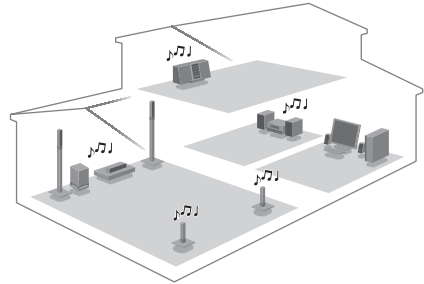

You can play the same audio at the same time across all Sony components which are compatible with the PARTY STREAMING function.

The component that plays audio for the party through the use of [Start Party] is called the “party host.” A component that is invited to the party from the party host and plays the same audio as the party host is called a “party guest.”

### To start a party (for the party host only)



You can use other components to play the content that is playing on the system.

- 1 **Turn on the system and other Sony components compatible with the PARTY STREAMING function.**  
Make sure that each component is connected to the network.
- 2 Press  $\leftarrow/\rightarrow/\uparrow/\downarrow$  to select the audio content in  $\text{[Music]}$  or a radio station.  
For selecting a radio station, see “Listening to the Radio” (page 42).
- 3 Press **OPTIONS**.

- 4** Press  $\uparrow/\downarrow$  to select [Start Party], then press  $\oplus$ .
- All party guests' components start playing the same audio content as the party host.

### To join in a party (for a party guest only)

You can use the system to play the content that is playing on other components.

- 1** Turn on the system and other Sony components compatible with the PARTY STREAMING function.  
Make sure that each component is connected to the network.
- 2** Start a party on another networked component.
- 3** Press  $\leftarrow/\rightarrow$  to select  [Music].
- 4** Press  $\uparrow/\downarrow$  to select  [Party], then press  $\oplus$ .
- 5** Press  $\uparrow/\downarrow$  to select the party host that you set up in Step 2, then press  $\oplus$ .

### To close a party

#### For the party host

Press  $\blacksquare$ , then press HOME.

#### For a party guest

Press OPTIONS, press  $\uparrow/\downarrow$  to select [Close Party], then press  $\oplus$  in Step 3 above.

### To leave from a party (for a party guest only)

Press OPTIONS, press  $\uparrow/\downarrow$  to select [Leave Party], then press  $\oplus$ .

#### Note

- The sale and product lineup of products that are compatible with the PARTY STREAMING function differ depending on the area.

## Operating the system with a DLNA controller (renderer)

#### Note

- If [Renderer Options] (page 54) is not displayed on the TV screen, this function may be available via a future update. However, the function may not be available in some regions/countries.

You can operate the system with a DLNA controller.

For details of operation, see the operating instructions of the DLNA controller.

#### Note

- Do not operate the system with the supplied remote when operating the system by the DLNA controller.

#### Tip

- The system is compatible with the "Play To" function of Windows Media® Player 12 that comes standard with Windows 7.

# Available Options

Various settings and playback operations are available by pressing **OPTIONS**. The available items differ depending on the situation.

## Common options

Items	Details
[Playback History List]	Displays titles/tracks in the playback history of a BD-ROM/DVD-ROM/CD-DA (music CD) by using Gracenote technology.
[Search History]	Searches for related information based on keywords from Gracenote via the Information Display.
[Search Contents]	Searches for BRAVIA Internet Video content based on keywords from Gracenote via the Information Display.
[Repeat Setting]	Sets the repeat play.
[Favorites List]	Displays the Favorites List.
[Play/Stop]	Starts or stops playback.
[Play from beginning]	Plays the item from the beginning.
[Information Display]	Displays information on the BD-ROM/DVD-ROM/CD-DA (music CD) by using Gracenote technology.
[Add to Favorites]	Adds an Internet content to the Favorites List.
[Remove from Favorites]	Erases an Internet content from the Favorites List.
[Start Party]	Starts a party with the selected source. This item may not appear depending on the source.
[Leave Party]	Leaves from a party which the system is participating in. The PARTY STREAMING function continues among other participating devices.
[Close Party]	Closes a party which the system is participating in. The PARTY STREAMING function ends for all other participating devices.

## [Video] only

Items	Details
[3D Output Setting]	Sets whether or not to output 3D video automatically.
[Video Settings]	<ul style="list-style-type: none"> <li>• [Picture Quality Mode]: Selects the picture settings for different lighting environments.</li> <li>• [FNR]: Reduces the random noise appearing in the picture.</li> <li>• [BNR]: Reduces the mosaic-like block noise in the picture.</li> <li>• [MNR]: Reduces minor noise around the picture outlines (mosquito noise).</li> </ul>
[Play/Pause]	Starts or pauses playback.
[Top Menu]	Displays the BD's or DVD's Top Menu.
[Menu/Popup Menu]	Displays the BD-ROM's Pop-up Menu or DVD's menu.
[Title Search]	Searches for a title on BD-ROMs/DVD VIDEOS and starts playback from the beginning.
[Chapter Search]	Searches for a chapter and starts playback from the beginning.
[Angle]	Switches to other viewing angles when multi-angles are recorded on BD-ROMs/DVD VIDEOS.

## [Music] only

Items	Details
[Add Slideshow BGM]	Registers music files in the USB memory as slideshow background music.

## [Photo] only

Items	Details
[Slideshow]	Starts a slideshow.
[Slideshow Speed]	Changes the slideshow speed.
[Slideshow Effect]	Sets the effect when playing a slideshow.

Items	Details
[Slideshow BGM]	<ul style="list-style-type: none"> <li>• [Off]: Turns off the function.</li> <li>• [My Music from USB]: Sets the music files registered in [Add Slideshow BGM]. If no music file is registered, [(Not registered)] is displayed.</li> <li>• [Play from disc]: Sets the tracks on CD-DAs (music CDs).</li> </ul>
[Rotate Left]	Rotates the photo counterclockwise by 90 degrees.
[Rotate Right]	Rotates the photo clockwise by 90 degrees.
[View Image]	Displays the selected picture.

## Adjusting the delay between the picture and sound

### (A/V SYNC)

When the sound does not match the pictures on the TV screen, you can adjust the delay between the picture and sound.

**1** Press **SYSTEM MENU**.

**2** Press **↑/↓** repeatedly until “A/V SYNC” appears in the front panel display, then press **+** or **→**.

**3** Press **↑/↓** to adjust the delay between the picture and sound.

You can adjust from 0 ms to 300 ms in 25 ms increments.

**4** Press **+**.

The setting is made.

**5** Press **SYSTEM MENU**.

The system menu turns off.

#### Note

- Depending on the input stream, A/V SYNC may not be effective.

## Sound Adjustment

# Selecting the Effect to Suit the Source

You can select a suitable sound mode for movies or music.

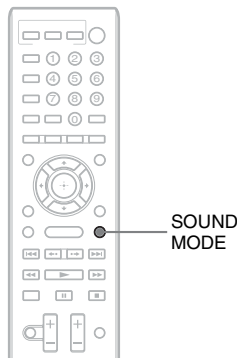

**Press SOUND MODE repeatedly during playback until the desired mode appears in the front panel display.**

- **“AUTO”**: The system selects “MOVIE” or “MUSIC” automatically to produce the sound effect depending on the disc or sound stream.
- **“MOVIE”**: The system provides the sound for movies.
- **“MUSIC”**: The system provides the sound for music.
- **“SPORTS”**: The system adds reverberation for sports programs.
- **“NEWS”**: The system provides the sound for voice programs, such as news.
- **“GAME ROCK”**: The system provides the sound for music/rhythm games.

### Note

- Depending on the disc or source, when you select “AUTO,” the beginning of the sound may be cut off as the system selects the optimum mode automatically. To avoid cutting the sound, select other than “AUTO.”
- Depending on the input stream, the sound mode may not be effective.
- When you play a Super Audio CD, this function does not work.

# Selecting the Audio Format, Multilingual Tracks, or Channel

When the system is playing a BD/DVD VIDEO recorded in multiple audio formats (PCM, Dolby Digital, MPEG audio, or DTS) or multilingual tracks, you can change the audio format or language.

With a CD, you can select the sound from the right or left channel and listen to the sound of the selected channel through both the right and left speakers.

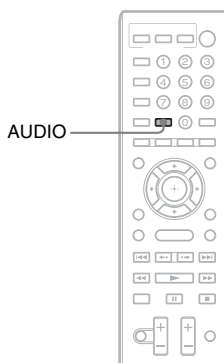

**Press AUDIO repeatedly during playback to select the desired audio signal.**

The audio information appears on the TV screen.



## ■ BD/DVD VIDEO

Depending on the BD/DVD VIDEO, the choice of language varies.

When 4 digits are displayed, they indicate a language code. See “Language Code List” (page 69) to confirm which language the code represents. When the same language is displayed two or more times, the BD/DVD VIDEO is recorded in multiple audio formats.

## ■ DVD-VR

The types of sound tracks recorded on a disc are displayed.

Example:

- [♪ Stereo]
- [♪ Stereo (Audio1)]
- [♪ Stereo (Audio2)]
- [♪ Main]
- [♪ Sub]
- [♪ Main/Sub]

### Note

- [♪ Stereo (Audio1)] and [♪ Stereo (Audio2)] do not appear when only one audio stream is recorded on the disc.

## ■ CD

- [♪ Stereo]: The standard stereo sound.
- [♪ 1/L]: The sound of the left channel (monaural).
- [♪ 2/R]: The sound of the right channel (monaural).

# Enjoying Multiplex Broadcast Sound

## (DUAL MONO)

You can enjoy multiplex broadcast sound when the system receives or plays a Dolby Digital multiplex broadcast signal.

### Note

- To receive the Dolby Digital signal, you need to connect a TV or other component to the unit with a digital optical cord (pages 22, 23). If your TV is compatible with the Audio Return Channel function (page 46), you can receive a Dolby Digital signal via an HDMI cable.

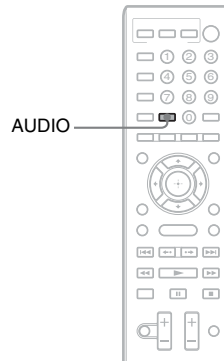

**Press AUDIO repeatedly until the desired signal appears in the front panel display.**

- “MAIN”\*: Sound of the main language will be output.
- “SUB”\*: Sound of the sub language will be output.
- “MAIN/SUB”\*: Mixed sound of both the main and sub languages will be output.

## Listening to the Radio

You can enjoy radio sound with the system's speakers.

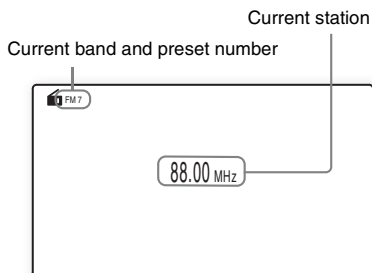
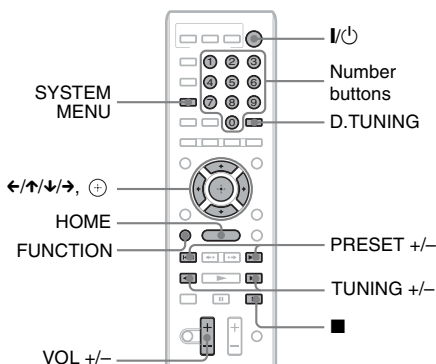

- 1 Press **FUNCTION** repeatedly until "TUNER FM" appears in the front panel display.

- 2 Select the radio station.

### Automatic tuning

Press and hold **TUNING +/-** until the auto scanning starts.

[Auto Tuning] appears on the TV screen. Scanning stops when the system tunes in a station.

To stop the automatic tuning manually, press **TUNING +/-** or **■**.

### Manual tuning

Press **TUNING +/-** repeatedly.

- 3 Adjust the volume by pressing **VOL +/-**.

### If an FM program is noisy

If an FM program is noisy, you can select monaural reception. There will be no stereo effect, but reception will improve.

- 1 Press **SYSTEM MENU**.
- 2 Press **↑/↓** repeatedly until "FM MODE" appears in the front panel display.



- 3 Press **+** or **→**.
- 4 Press **↑/↓** to select "MONO."
  - "STEREO": Stereo reception.
  - "MONO": Monaural reception. "MONO" appears in the front panel display.

- 5 Press **SYSTEM MENU**.

The system menu turns off.

### To turn off the radio

Press **I/Power**.

## Presetting radio stations

You can preset up to 20 stations. Before tuning, make sure to turn down the volume to minimum.

- 1 Press **FUNCTION** repeatedly until "TUNER FM" appears in the front panel display.

- 2 Press and hold **TUNING +/-** until the auto scanning starts.

Scanning stops when the system tunes in a station.

- 3 Press **SYSTEM MENU**.

- 4 Press **↑/↓** repeatedly until "MEMORY" appears in the front panel display, then press **+** or **→**.

A preset number appears in the front panel display.

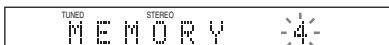

- 5** Press  $\uparrow/\downarrow$  to select the preset number you want.

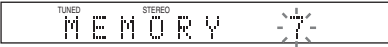

**Tip**

- You can select the preset number directly by pressing the number buttons.

- 6** Press  $\oplus$ .

“COMPLETE” appears in the front panel display, and the station is stored.

- 7** Repeat Steps 2 to 6 to store other stations.

- 8** Press SYSTEM MENU.

The system menu turns off.

### To change the preset number

Select the desired preset number by pressing PRESET +/-, then perform the procedure from Step 3.

## Selecting the preset station

- 1** Press FUNCTION repeatedly until “TUNER FM” appears in the front panel display.

The last received station is tuned in.

- 2** Press PRESET +/- repeatedly to select the preset station.

The preset number and frequency appear on the TV screen and front panel display.

Each time you press the button, the system tunes in one preset station.

**Tip**

- You can select the preset station number directly by pressing the number buttons.

## Selecting a radio station by inputting a frequency directly

When you know the frequencies, you can select radio stations by inputting the frequencies directly.

- 1** Press FUNCTION repeatedly until “TUNER FM” appears in the front panel display.

- 2** Press D.TUNING.

- 3** Press the number buttons to select the frequencies.

- 4** Press  $\oplus$ .

# Using the Control for HDMI Function for “BRAVIA” Sync

This function is available on TVs with the “BRAVIA” Sync function.

By connecting Sony components that are compatible with the Control for HDMI function with an HDMI cable, operation is simplified as below:

- System Power Off (page 45)
- One-Touch Play (page 45)
- Theater Mode (page 45)
- System Audio Control (page 45)
- Volume Limit (page 45)
- Audio Return Channel (page 46)
- Remote Easy Control (page 46)
- Language Follow (page 46)

Control for HDMI is a mutual control function standard used by CEC (Consumer Electronics Control) for HDMI (High-Definition Multimedia Interface).

The Control for HDMI function will not work when you connect this system to a component which is not compatible with the Control for HDMI function.

There are convenient buttons on the system’s remote for operating the TV, such as THEATER, ONE-TOUCH PLAY, and TV I/⏻. For details, see “Remote control” (page 12) and refer to the operating instructions of the TV.

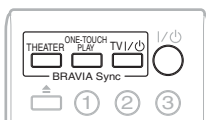

### Note

- Depending on the connected component, the Control for HDMI function may not work. Refer to the operating instructions supplied with the component.

- The Control for HDMI function may not work if you connect other than a Sony component, even if the component is compatible with the Control for HDMI function.

## Preparing for the Control for HDMI function

### (Control for HDMI - Easy Setting)

If your TV is compatible with the Control for HDMI - Easy Setting function, you can set the system’s [Control for HDMI] function automatically by setting the TV. For details, refer to the operating instructions of the TV.

If the TV is not compatible with the Control for HDMI - Easy Setting function, set the Control for HDMI function of the system and TV manually.

### Note

- For details on setting the TV, refer to the operating instructions of the TV.

- 1** Make sure that the system and the TV are connected with an HDMI cable.
- 2** Turn on the TV and press I/⏻ to turn on the system.
- 3** Set the Control for HDMI function of the system and TV.

The Control for HDMI function for the system and TV is simultaneously set to on.

### To set the [Control for HDMI] function of the system to on/off manually

- 1** Press HOME.  
The home menu appears on the TV screen.
- 2** Press ←/→ to select [Setup].
- 3** Press ↑/↓ to select [System Settings], then press ⊕.
- 4** Press ↑/↓ to select [HDMI Settings], then press ⊕.  
The [HDMI Settings] display appears.
- 5** Press ↑/↓ to select [Control for HDMI], then press ⊕.

**6** Press  $\uparrow/\downarrow$  to select the setting, then press  $\oplus$ .

- [On]: On.
- [Off]: Off.

## Turning the system off in sync with the TV

### (System Power Off)

When you turn the TV off by using the POWER button on the TV's remote or TV  $\text{I}/\text{O}$  on the system's remote, the system turns off automatically.

#### Note

- This function depends on the settings of your TV. For details, refer to the operating instructions of the TV.

## Watching BD/DVD by a single button press

### (One-Touch Play)

Press **ONE-TOUCH PLAY**.

The system and your TV turn on, your TV's input is set to the HDMI input to which the system is connected, and the system starts playing a disc automatically.

The System Audio Control function is also activated automatically.

Also, when you insert a disc, One-Touch Play is enabled. If One-Touch Play does not start (in the case of inserting a disc that is not compatible with the auto playback function), press **FUNCTION** repeatedly to select "BD/DVD" and press  $\blacktriangleright$  or **ONE-TOUCH PLAY**.

## Using the Theater Mode

### (Theater Mode)

Press **THEATER**.

If your TV is compatible with the Theater Mode, you can enjoy optimal image and sound quality suited for movies, and the System Audio Control function is activated automatically.

## Enjoying TV sound from the speakers in this system

### (System Audio Control)

You can simplify operation to enjoy TV sound via this system.

To use this function, connect the system and the TV with an audio cord and an HDMI cable (page 21, 22).

You can use the System Audio Control function as follows:

- When the system is turned on, TV sound can be output from the speakers of the system.
- When TV sound is output from the speakers of the system, you can change the output method to the speakers of the TV via the TV menu.
- When TV sound is output from the speakers of the system, you can adjust the volume and turn off the sound of the system using the TV remote.

#### Note

- While the TV is in PAP (picture and picture) mode, the System Audio Control function will not work.
- Depending on the TV, when you adjust the unit's volume, the volume level appears on the TV screen. In this case, the volume level that appears on the TV screen and the unit's front panel display may differ.

## Setting the Maximum Volume Level of the System

### (Volume Limit)

When the System Audio Control function is activated, loud sound may be output depending on the volume level of the system. You can prevent this by limiting the maximum level of the volume. For details, see [Volume Limit] (page 53).

## Receiving the digital audio signal of the TV

### (Audio Return Channel)

The system can receive the digital audio signal of the TV via an HDMI cable when your TV is compatible with the Audio Return Channel function. You can enjoy TV sound via the system by using just one HDMI cable. For details, see [Audio Return Channel] (page 53).

## Operating the system via the TV remote

### (Remote Easy Control)

You can control the basic functions of the system via the TV remote when the system's video output is displayed on the TV screen. For details, refer to the operating instructions of the TV.

## Changing the language for the on-screen display of the TV

### (Language Follow)

When you change the language for the on-screen display of the TV, the system's on-screen display language is also changed after turning the system off and on.

## Setting the Speakers

### [Speaker Settings]

To obtain the best possible surround sound, set connection of the speakers and their distance from your listening position.

- 1 Press HOME.**  
The home menu appears on the TV screen.
- 2 Press </> to select  [Setup].**
- 3 Press ↑/↓ to select [Audio Settings], then press +.**
- 4 Press ↑/↓ to select [Speaker Settings], then press +.**  
The [Speaker Settings] display appears.
- 5 Press ↑/↓ to select the item, then press +.**

Check the following settings.

### ■ [Distance]

When you move the speakers, be sure to set the parameters of the distance (A) from the listening position to the speakers.

You can set the parameters from 0 to 23 feet (0.0 to 7.0 meters).

The speakers in the illustration correspond to the following:

- ① Front speaker
- ② Subwoofer

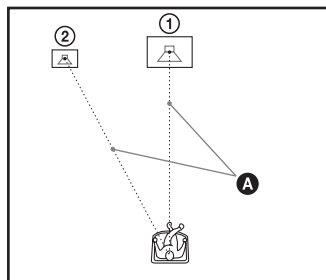

[Front] 10 ft/3.0 m: Set the front speaker distance.

[Subwoofer] 10 ft/3.0 m: Set the subwoofer distance.

**Note**

- Depending on the input stream, [Distance] may not be effective.

**Tip**

- You can change measurement units (feet or meters) by pressing the color button (RED).

**■ [Level]**

You can adjust the sound level of the subwoofer. You can set the parameters from -6.0 dB to +6.0 dB.

[Subwoofer] 0.0 dB: Set the subwoofer level.

## Using the Sleep Timer

You can set the system to turn off at a preset time, so you can fall asleep listening to music. The time can be preset in intervals of 10 minutes.

**Press SLEEP.**

Each time you press SLEEP, the minutes display (the remaining time) changes by 10 minutes. When you set the sleep timer, "SLEEP" flashes in the front panel display.

**To check the remaining time**

Press SLEEP once.

**To change the remaining time**

Press SLEEP repeatedly to select the desired time.

## Changing the Illumination LED Lighting Type

**(Illumination Mode)**

You can select to have the illumination LED light up either perpetually or only when you press a button.

**1 Press SYSTEM MENU.****2 Press ↑/↓ repeatedly until "ILLUM MODE" appears in the front panel display, then press ⊕ or →.****3 Press ↑/↓ to select a setting.**

- "STANDARD": turns on the illumination at all times.
- "SIMPLE": turns on the illumination for about 10 seconds when you press a button on the unit.

**4 Press ⊕.**

The setting is made.

## Deactivating the Buttons on the Unit

**(Child Lock)**

You can deactivate the buttons on the unit (except for I/⏻) for preventing misoperation, such as child mischief (child lock function).

**Press ■ on the unit for more than 5 seconds.**

"CHILD LOCK" and "ON" appear in the front panel display.

The child lock function is activated and the buttons on the unit are locked. (You can operate the system by using the remote.)

To cancel, press ■ for more than 5 seconds so that "CHILD LOCK" and "OFF" appear in the front panel display.

**Note**

- When you operate the buttons on the unit while the child lock function is on, "CHILD LOCK" appears in the front panel display.

# Controlling Your TV with the Supplied Remote

By adjusting the remote signal, you can control your TV with the supplied remote.

## Note

- When you replace the batteries of the remote, the code number may reset itself to the default (SONY) setting. Reset the appropriate code number.

## Preparing the remote for controlling the TV

**Press and hold TV I/⏻ while entering your TV's manufacturer's code (see the table) using the number buttons. Then release TV I/⏻.**

If the setting is unsuccessful, the currently registered code is not changed. Re-enter the code number.

### Code numbers of controllable TVs

If more than one code number is listed, try entering them one at a time until you find the code that works with your TV.

Manufacturer	Code number
SONY	01 (default)
SAMSUNG	02, 06
PANASONIC	05
LG	02
TOSHIBA	04
SHARP	03

## Saving Power in Standby Mode

Check that the following settings in [System Settings] are made:

- [Control for HDMI] in [HDMI Settings] is set to [Off] (page 44).
- [Quick Start Mode] is set to [Off] (page 53).



## Using the Setup Display

You can make various adjustments of items such as picture and sound.

Select  (Setup) on the home menu when you need to change the settings of the system.

The default settings are underlined.

**Note**

- Playback settings stored in the disc take priority over the Setup Display settings and not all the functions described may work.

**1 Press HOME.**

The home menu appears on the TV screen.

**2 Press </> to select  [Setup].**

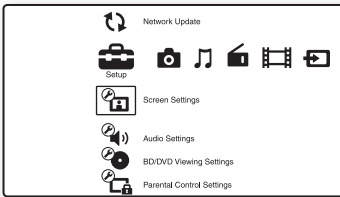





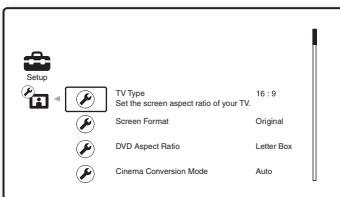





**3 Press ↑/↓ to select the setup category icon to change, then press +.**

Example: [Screen Settings]



You can setup the following options.

Icon	Explanation
	<b>[Network Update] (page 49)</b> Updates the software of the system.
	<b>[Screen Settings] (page 50)</b> Makes the screen settings according to the type of connecting jacks.

Icon	Explanation
	<b>[Audio Settings] (page 51)</b> Makes the audio settings according to the type of connecting jacks.
	<b>[BD/DVD Viewing Settings] (page 52)</b> Makes detailed settings for BD/DVD playback.
	<b>[Parental Control Settings] (page 52)</b> Makes detailed settings for the Parental Control function.
	<b>[Music Settings] (page 53)</b> Makes detailed settings for Super Audio CD playback.
	<b>[System Settings] (page 53)</b> Makes the system-related settings.
	<b>[Network Settings] (page 54)</b> Makes detailed settings for Internet and network.
	<b>[Easy Setup] (page 55)</b> Re-runs the Easy Setup to make the basic settings.
	<b>[Resetting] (page 55)</b> Resets the system to the factory settings.

## [Network Update]

You can update and improve the functions of the system.

For information about update functions, refer to the following website:

<http://www.sony.com/bluraysupport/>



## Screen Settings

### ■ [3D Output Setting]

[Auto]: Normally select this.

[Off]: Select this to display all contents in 2D.

### ■ [TV Screen Size Setting for 3D]

Sets the screen size of your 3D compatible TV.

### ■ [TV Type]

[16:9]: Select this when connecting to a wide-screen TV or a TV with a wide-mode function.

[4:3]: Select this when connecting to a 4:3 screen TV without a wide-mode function.

### ■ [Screen Format]

[Original]: Select this when connecting to a TV with a wide-mode function. Displays a 4:3 screen picture in 16:9 aspect ratio even on a wide-screen TV.

[Fixed Aspect Ratio]: Changes the picture size to fit the screen size with the original picture aspect ratio.

### ■ [DVD Aspect Ratio]

[Letter Box]: Displays a wide picture with black bands on the top and bottom.



[Pan & Scan]: Displays a full-height picture on the entire screen, with trimmed sides.



### ■ [Cinema Conversion Mode]

[Auto]: Normally select this. The unit automatically detects whether the material is video-based or film-based, and switches to the appropriate conversion method.

[Video]: The conversion method suited for video-based material will always be selected regardless of the material.

### ■ [Output Video Format]

[HDMI]: Normally select [Auto]. Select [Original Resolution] to output the resolution recorded on the disc. (When the resolution is lower than SD resolution, it is scaled up to SD resolution.)

[Video]: Automatically sets the lowest resolution.

#### Note

- When connecting the HDMI OUT jack and VIDEO OUT jack at the same time, select [Video].
- If no picture appears when setting [HDMI] resolution, select [Video].

### ■ [BD/DVD-ROM 1080/24p Output]

[Auto]: Outputs 1920 × 1080p/24 Hz video signals only when connecting a 1080/24p-compatible TV using the HDMI OUT jack.

[Off]: Select this when your TV is not compatible with 1080/24p video signals.

### ■ [YCbCr/RGB (HDMI)]

[Auto]: Automatically detects the type of external device, and switches to the matching color setting.

[YCbCr (4:2:2)]: Outputs YCbCr 4:2:2 video signals.

[YCbCr (4:4:4)]: Outputs YCbCr 4:4:4 video signals.

[RGB]: Select this when connecting to a device with an HDCP-compliant DVI jack.

### ■ [HDMI Deep Color Output]

[Auto]: Normally select this.

[12bit], [10bit]: Outputs 12bit/10bit video signals when the connected TV is compatible with Deep Color.

[Off]: Select this when the picture is unstable or colors appear unnatural.

### ■ [Pause Mode] (BD/DVD VIDEO/DVD-R/DVD-RW only)

[Auto]: The picture, including subjects that move dynamically, is output with no jitter. Normally select this position.

[Frame]: The picture, including subjects that do not move dynamically, is output in high resolution.

---

 **[Audio Settings]**

---

**■ [BD Audio MIX Setting]**

[On]: Outputs the audio obtained by mixing the interactive audio and secondary audio to the primary audio.

[Off]: Outputs the primary audio only. Select this when outputting HD audio signals to an AV receiver.

---

**■ [DTS Neo:6]**

Simulates multichannel surround sound from 2 channel sources according to the capability of the connected device, and outputs the sound via the HDMI OUT jack.

[Cinema]: Outputs simulated multichannel sound from 2 channel sources using DTS Neo:6 Cinema mode.

[Music]: Outputs simulated multichannel sound from 2 channel sources using DTS Neo:6 Music mode.

[Off]: Outputs sound with its original number of channels.

---

**■ [Audio DRC]**

You can compress the dynamic range of the sound track.

[Auto]: Performs playback at the dynamic range specified by the disc (BD-ROM only).

[Off]: No compression of dynamic range.

[On]: The system reproduces the sound track with the kind of dynamic range that the recording engineer intended.

---

**■ [Attenuate - AUDIO]**

Distortion may occur when you listen to a component connected to the AUDIO (IN L/R) jacks. You can prevent distortion by reducing the input level on the unit.

[On]: Attenuates the input level. The output level is changed.

[Off]: Normal input level.

---

**■ [Audio Output]**

[Speaker]: Outputs sound from the system's speakers only.

[Speaker + HDMI]: Outputs sound from the system's speakers and 2-channel linear PCM signals from the HDMI OUT jack.

[HDMI]: Outputs sound from the HDMI OUT jack only. Sound format depends on the connected component.

---

**Note**

- Even if [HDMI] or [Speaker + HDMI] is selected, the sound of functions other than "BD/DVD" or "D.MEDIA" is output from the system's speakers, not from the HDMI OUT jack.
  - When you set [Audio Output] to [HDMI], the SOUND MODE and "SUR.SETTING" functions are disabled.
  - When the System Audio Control function (page 45) is activated, this setting may change automatically.
- 

**■ [Sound Effect]**

You can set the system's sound effects (SOUND MODE and "SUR.SETTING") to on/off.

[On]: Enables all of the system's sound effects. The upper limit of sampling frequency is set to 48 kHz.

[Off]: The sound effects are disabled. Select this when you do not want to set the upper limit of sampling frequency.

---

**■ [Speaker Settings]**

To obtain the best possible surround sound, set the speakers. For details, see "Setting the Speakers" (page 46).

---

---

## [BD/DVD Viewing Settings]

You can make detailed settings for BD/DVD playback.

---

### ■ [BD/DVD Menu]

You can select the default menu language for BD-ROMs or DVD VIDEOS.

When you select [Select Language Code], the display for entering the language code appears. Enter the code for your language by referring to “Language Code List” (page 69).

---

### ■ [Audio]

You can select the default track language for BD-ROMs or DVD VIDEOS.

When you select [Original], the language given priority in the disc is selected.

When you select [Select Language Code], the display for entering the language code appears. Enter the code for your language by referring to “Language Code List” (page 69).

---

### ■ [Subtitle]

You can select the default subtitle language for BD-ROMs or DVD VIDEOS.

When you select [Select Language Code], the display for entering the language code appears. Enter the code for your language by referring to “Language Code List” (page 69).

---

### ■ [BD Hybrid Disc Playback Layer]

[BD]: Plays BD layer.

[DVD/CD]: Plays DVD or CD layer.

---

### ■ [BD Internet Connection]

[Allow]: Normally select this.

[Do not allow]: Prohibits Internet connection.

---

---

### ■ [BD Data Jack Selection]

[Internal memory]: Selects the internal memory to store BD data.

[USB device (left)]: Selects the  (USB) port on the left side of the unit to store BD data.

[USB device (right)]: Selects the  (USB) port of the side panel on the right of the unit to store BD data.

---

---

## [Parental Control Settings]

---

### ■ [Password]

Set or change the password for the Parental Control function. A password allows you to set a restriction on BD-ROM, DVD VIDEO, or Internet video playback. If necessary, you can differentiate the restriction levels for BD-ROMs and DVD VIDEOS.

---

### ■ [Parental Control Area Code]

Playback of some BD-ROMs or DVD VIDEOS can be limited according to the geographic area. Scenes may be blocked or replaced with different scenes. Follow the on-screen instructions and enter your four-digit password.

---

### ■ [BD Parental Control]

Playback of some BD-ROMs can be limited according to the age of the users. Scenes may be blocked or replaced with different scenes. Follow the on-screen instructions and enter your four-digit password.

---

### ■ [DVD Parental Control]

Playback of some DVD VIDEOS can be limited according to a predetermined level such as the age of the users. Scenes may be blocked or replaced with different scenes. Follow the on-screen instructions and enter your four-digit password.

---

**■ [Internet Video Parental Control]**

Playback of some Internet videos can be limited according to the age of the users. Scenes may be blocked or replaced with different scenes. Follow the on-screen instructions and enter your four-digit password.

**■ [Internet Video Unrated]**

[Allow]: Allows the playback of unrated Internet videos.

[Block]: Blocks the playback of unrated Internet videos.

**[Music Settings]**

You can make detailed settings for Super Audio CD playback.

**■ [Super Audio CD Playback Layer]**

[Super Audio CD]: Plays the Super Audio CD layer.

[CD]: Plays the CD layer.

**■ [Super Audio CD Playback Channel]**

[DSD 2ch]: Plays the 2ch area.

[DSD Multi]: Plays the multi-channel area.

**[System Settings]**

You can make the system-related settings.

**■ [OSD]**

You can select your language for the system on-screen displays.

**■ [Dimmer]**

[Bright]: Bright lighting.

[Dark]: Low lighting.

**■ [HDMI Settings]**

By connecting Sony components that are compatible with the Control for HDMI function with an HDMI cable, operation is simplified. For details, see “Using the Control for HDMI Function for “BRAVIA” Sync” (page 44).

[Control for HDMI]

You can set the [Control for HDMI] function to on/off.

[On]: On. You can operate mutually between components that are connected with an HDMI cable.

[Off]: Off.

[Audio Return Channel]

This function is available when you connect the system and TV that is compatible with the Audio Return Channel function.

[Auto]: The system can receive the digital audio signal of the TV automatically via an HDMI cable.

[Off]: Off.

**Note**

- This function is available only when [Control for HDMI] is set to [On].

[Volume Limit]

When the System Audio Control function (page 45) is activated, loud sound may be output depending on the volume level of the system. You can prevent this by limiting the maximum level of the volume when the System Audio Control function activates.

[Level3]: Maximum volume level is set to 15.

[Level2]: Maximum volume level is set to 20.

[Level1]: Maximum volume level is set to 30.

[Off]: Off.

**Note**

- This function is available only when [Control for HDMI] is set to [On].

**■ [Quick Start Mode]**

[On]: Shortens the startup time from standby mode. You can operate the system quickly after turning it on.

[Off]: The default setting.

---

### ■ [Auto Standby]

[On]: Turns on the [Auto Standby] function. When you do not operate the system for about 30 minutes, the system enters standby mode automatically.

[Off]: Turns off the function.

#### Note

- This function does not work while the sleep timer is set.

---

### ■ [Auto Display]

[On]: Automatically displays information on the screen when changing the viewing titles, picture modes, audio signals, etc.

[Off]: Displays information only when you press DISPLAY.

---

### ■ [Screen Saver]

[On]: Turns on the screen saver function.

[Off]: Off.

---

### ■ [Software Update Notification]

[On]: Sets the system to inform you of newer software version information (page 49).

[Off]: Off.

---

### ■ [Gracenote Settings]

[Auto]: Automatically downloads disc information when you stop playback of the disc. To download, the system must be connected to the network.

[Manual]: Downloads disc information when you select [Playback History List] or [Information Display] in the options menu.

---

### ■ [System Information]

You can display the system's software version information and the MAC address.

---

## [Network Settings]

You can make detailed settings for Internet and network.

---

### ■ [Internet Settings]

Connect the system to the network beforehand. For details, see "Step 3: Connecting to the Network" (page 25).

[View Network Status]: Displays the current network status.

[Wired Setup]: Select this when you connect to a broadband router directly.

[USB Wireless Setup]: Select this when you use a USB Wireless LAN Adapter.

For more information, go to <http://www.sony.com/bluraysupport/>

---

### ■ [Network Connection Diagnostics]

You can run the network diagnostic to check if the network connection has been made properly.

---

### ■ [Connection Server Settings]

Sets whether or not to display the connected server.

---

### ■ [Renderer Options]

[Auto Access Permission]: Sets whether or not to allow automatic access from newly detected DLNA controller.

[Smart Select]: Allows a Sony DLNA controller to find the system as the target component to operate by using the infrared ray. You can set this function to on or off.

[Renderer Name]: Displays the system's name as it is listed on other DLNA devices on the network.

---

### ■ [Renderer Access Control]

Sets whether or not to accept commands from DLNA controllers.

---

**■ [Party Auto Start]**

[On]: Starts a party or joins an existing party at the request of a networked device compatible with the PARTY STREAMING function.  
[Off]: Off.

---

**■ [BD Remote Device Registration]**

Registers your “BD remote” device.

---

**■ [Registered BD Remote Devices]**

Displays a list of your registered “BD remote” devices.

---

**[Easy Setup]**

Re-runs the Easy Setup to make the basic settings. Follow the on-screen instructions.

---

**[Resetting]****■ [Reset to Factory Default Settings]**

You can reset the system settings to the factory default by selecting the group of settings. All the settings within the group will be reset.

---

**■ [Initialize Personal Information]**

You can erase your personal information stored in the system.

---

# Precautions

### On safety

- To prevent fire or shock hazard, do not place objects filled with liquids, such as vases, on the system, or place the system near water, such as near a bathtub or shower room. Should any solid object or liquid fall into the cabinet, unplug the system and have it checked by qualified personnel before operating it any further.
- Do not touch the AC power cord (mains lead) with wet hands. Doing so may cause an electric shock.

### On power sources

- Unplug the unit from the wall outlet (mains) if you do not intend to use it for an extended period of time. To disconnect the cord, pull it out by the plug, never by the cord.

### On placement

- Place the system in a location with adequate ventilation to prevent heat build-up in the system.
- At high volume, over long periods of time, the cabinet becomes hot to the touch. This is not a malfunction. However, touching the cabinet should be avoided. Do not place the system in a confined space where ventilation is poor as this may cause overheating.
- Do not block the ventilation slots by putting anything on the system. The system is equipped with a high power amplifier. If the ventilation slots are blocked, the system can overheat and malfunction.
- Do not place the system on surfaces (rugs, blankets, etc.) or near materials (curtains, draperies) that may block the ventilation slots.
- Do not install the system in a confined space, such as a bookshelf or similar unit.
- Do not install the system near heat sources such as radiators, air ducts, or in a place subject to direct sunlight, excessive dust, mechanical vibration, or shock.
- Do not install the system on its face or back. It is designed to be operated in a vertical position only.
- Keep the system and discs away from components with strong magnets, such as microwave ovens, or large loudspeakers.
- Do not place heavy objects on the system.
- Do not place metal objects in front of the front panel. They may limit reception of radio waves.

- Do not place the system in a place where medical equipment is in use. It may cause a malfunction of medical equipment.
- If you use a pacemaker or other medical device, consult your physician or the manufacturer of your medical device before using the wireless LAN function.

### On operation

- If the system is brought directly from a cold to a warm location, or is placed in a very damp room, moisture may condense on the lenses inside the unit. Should this occur, the system may not operate properly. In this case, remove the disc and leave the system turned on for about half an hour until the moisture evaporates.
- When you move the system, take out any disc. If you do not, the disc may be damaged.
- If anything falls into the cabinet, unplug the unit and have it checked by qualified personnel before operating it any further.

### On adjusting volume

- Do not turn up the volume while listening to a section with very low level inputs or no audio signals. If you do, the speakers may be damaged when a peak level section is suddenly played.

### On cleaning

- Clean the cabinet, panel, and controls with a soft cloth slightly moistened with a mild detergent solution. Do not use any type of abrasive pad, scouring powder or solvent such as alcohol or benzene. If you have any questions or problems concerning your system, please consult your nearest Sony dealer.

### On cleaning discs, disc/lens cleaners

- **Do not use cleaning discs or disc/lens cleaners (including wet or spray types). These may cause the apparatus to malfunction.**

### On replacement of parts

- In the events that this system is repaired, repaired parts may be collected for reuse or recycling purposes.

### On your TV's color

- If the speakers should cause the TV screen to have color irregularity, turn off the TV then turn it on after 15 to 30 minutes. If color irregularity should persist, place the speakers further away from the TV set.



### IMPORTANT NOTICE

Caution: This system is capable of holding a still video image or on-screen display image on your television screen indefinitely. If you leave the still video image or on-screen display image displayed on your TV for an extended period of time you risk permanent damage to your television screen. Projection televisions are especially susceptible to this.

This system can only play a standard circular disc. Using neither standard nor circular discs (e.g., card, heart, or star shape) may cause a malfunction.

Do not use a disc that has a commercially available accessory attached, such as a label or ring.

Do not use a lens cleaning disc.

### On moving the system

- Before moving the system, make sure that there is no disc inserted, and remove the AC power cord (mains lead) from the wall outlet (mains).

---

## Notes about the Discs

### On handling discs

- To keep the disc clean, handle the disc by its edge. Do not touch the surface.
- Do not stick paper or tape on the disc.



- Do not expose the disc to direct sunlight or heat sources such as hot air ducts, or leave it in a car parked in direct sunlight as the temperature may rise considerably inside the car.
- After playing, store the disc in its case.

### On cleaning

- Before playing, clean the disc with a cleaning cloth. Wipe the disc from the center out.



- Do not use solvents such as benzine, thinner, commercially available cleaners, or anti-static spray intended for vinyl LPs.

# Troubleshooting

If you experience any of the following difficulties while using the system, use this troubleshooting guide to help remedy the problem before requesting repairs. Should any problem persist, consult your nearest Sony dealer.

Note that if service personnel changes some parts during repair, these parts may be retained.

## Power

Symptom	Problems and solutions
The power is not turned on.	<ul style="list-style-type: none"><li>• Check that the AC power cord (mains lead) is connected securely.</li></ul>
“PROTECTOR” and “PUSH POWER” appear alternately in the front panel display.	<p>Press  to turn off the system, and check the following items after “STANDBY” disappears.</p> <ul style="list-style-type: none"><li>• Are the + and – speaker cords short-circuited?</li><li>• Are you using only the specified speakers?</li><li>• Is anything blocking the ventilation holes of the system?</li><li>• After checking the above items and fixing any problems, turn on the system. If the cause of the problem cannot be found even after checking all the above items, consult your nearest Sony dealer.</li></ul>

## General

Symptom	Problems and solutions
The remote does not function.	<ul style="list-style-type: none"><li>• The distance between the remote and the unit is too far.</li><li>• The batteries in the remote are weak.</li><li>• When you cannot perform menu operations via the front panel display, press HOME on the remote.</li></ul>
The system does not work normally.	<ul style="list-style-type: none"><li>• Disconnect the AC power cord (mains lead) from the wall outlet (mains), then reconnect after several minutes.</li></ul>

## Picture

Symptom	Problems and solutions
There is no picture.	<ul style="list-style-type: none"><li>• Check the video connection (page 21).</li><li>• The unit is not connected to the correct TV input jack (page 21).</li><li>• The video input on the TV is not set so that you can view pictures from the system.</li><li>• Check the output method on your system (page 21).</li><li>• The unit is connected to an input device that is not HDCP (High-bandwidth Digital Content Protection) compliant (“HDMI” on the front panel does not light up) (page 21).</li><li>• When playing a double-layer DVD, the video and audio may be momentarily interrupted at the point where the layers switch.</li></ul>
3D images do not appear on the TV screen.	<ul style="list-style-type: none"><li>• Depending on the TV or video component, 3D images may not appear.</li></ul>
No picture appears when the video output resolution selected in [Output Video Format] is incorrect.	<ul style="list-style-type: none"><li>• Press and hold  and VOL – on the unit for more than 5 seconds to reset the video output resolution to the lowest resolution.</li></ul>

Symptom	Problems and solutions
Video signals are only output from the HDMI OUT jack when connecting the HDMI OUT jack and VIDEO OUT jack at the same time.	<ul style="list-style-type: none"> <li>• Set [Output Video Format] in [Screen Settings] to [Video] (page 50).</li> </ul>
The dark area of the picture is too dark/the bright area is too bright or unnatural.	<ul style="list-style-type: none"> <li>• Set [Picture Quality Mode] to [Standard] (default) (page 38).</li> </ul>
The picture is not output correctly.	<ul style="list-style-type: none"> <li>• Check the [Output Video Format] settings in [Screen Settings] (page 50).</li> <li>• If the analog and digital signals are output at the same time, set [BD/DVD-ROM 1080/24p Output] in [Screen Settings] to [Off] (page 50).</li> <li>• For BD-ROMs, check the [BD/DVD-ROM 1080/24p Output] settings in [Screen Settings] (page 50).</li> </ul>
Picture noise appears.	<ul style="list-style-type: none"> <li>• The disc is dirty or flawed.</li> <li>• If the picture output from your system goes through your VCR to get to your TV, the copy-protection signal applied to some BD/DVD programs could affect picture quality. If you still experience problems even when you connect your unit directly to your TV, try connecting your unit to the other input jacks.</li> </ul>
Even though you set the aspect ratio in [TV Type] of [Screen Settings], the picture does not fill the TV screen.	<ul style="list-style-type: none"> <li>• The aspect ratio on the disc is fixed.</li> </ul>
Color irregularity occurs on the TV screen.	<ul style="list-style-type: none"> <li>• If the speakers are used with a CRT-based TV or projector, install the speakers at least 1.0 foot (0.3 meters) from the TV set.</li> <li>• If the color irregularity persists, turn off the TV set once, then turn it on after 15 to 30 minutes.</li> <li>• Make sure that no magnetic object (magnetic latch on a TV stand, health care device, toy, etc.) is placed near the speakers.</li> </ul>



## Sound

Symptom	Problems and solutions
There is no sound.	<ul style="list-style-type: none"> <li>• The speaker cord is not connected securely.</li> <li>• Check the speaker settings (page 46).</li> <li>• Fast forward or fast reverse is being performed. Press ► to return to normal play mode.</li> <li>• Slow forward or freeze frame is being performed. Press ► to return to normal play mode.</li> </ul>
No sound is output from the HDMI OUT jack.	<ul style="list-style-type: none"> <li>• Set [Audio Output] to [HDMI] (page 51).</li> </ul>
The left and right sounds are unbalanced or reversed.	<ul style="list-style-type: none"> <li>• Check that the speaker and components are connected correctly and securely.</li> </ul>
There is no sound from the subwoofer.	<ul style="list-style-type: none"> <li>• Check the speaker connections and settings (pages 18, 46).</li> </ul>

Symptom	Problems and solutions
There is no digital sound from the HDMI OUT jack when using the Audio Return Channel function.	<ul style="list-style-type: none"> <li>• Set [Control for HDMI] in [HDMI Settings] of [System Settings] to [On] (page 53). Also, set [Audio Return Channel] in [HDMI Settings] of [System Settings] to [Auto] (page 53).</li> <li>• Make sure that your TV is compatible with the Audio Return Channel function.</li> <li>• Make sure that an HDMI cable is connected to a jack on your TV that is compatible with the Audio Return Channel function.</li> <li>• The sampling frequency of the input stream is more than 48 kHz.</li> </ul>
The system does not output sound correctly when connected to a set-top box.	<ul style="list-style-type: none"> <li>• Set [Audio Return Channel] in [HDMI Settings] of [System Settings] to [Off] (page 46).</li> </ul>
Severe hum or noise is heard.	<ul style="list-style-type: none"> <li>• Check that the connecting cords are away from a transformer or motor, and at least 10 feet (3 meters) away from your TV set or a fluorescent light.</li> <li>• Move your TV away from the audio components.</li> <li>• Clean the disc.</li> </ul>
The sound loses stereo effect when you play a CD.	<ul style="list-style-type: none"> <li>• Select stereo sound by pressing AUDIO (page 40).</li> </ul>
The surround effect is difficult to hear when you are playing a sound track of Dolby Digital, DTS, or MPEG audio.	<ul style="list-style-type: none"> <li>• Check the surround setting (page 31).</li> <li>• Check the speaker connections and settings (pages 18, 46).</li> <li>• Depending on the BD/DVD, the output signal may not be the entire 5.1 channel. It may be monaural or stereo even if the sound track is recorded in Dolby Digital or MPEG audio format.</li> </ul>
The beginning of the sound is cut off.	<ul style="list-style-type: none"> <li>• Set the sound mode to "MOVIE" or "MUSIC" (page 40).</li> <li>• Select "AUTO" for "SUR.SETTING" (page 31).</li> </ul>
The sound effects are disabled.	<ul style="list-style-type: none"> <li>• The effects of SOUND MODE and "SUR.SETTING" may be disabled depending on the input stream (page 51).</li> </ul>
Distortion occurs in the sound of a connected component.	<ul style="list-style-type: none"> <li>• Reduce the input level for the connected component by setting [Attenuate - AUDIO] (page 51).</li> </ul>

## Operation

Symptom	Problems and solutions
Radio stations cannot be tuned in.	<ul style="list-style-type: none"> <li>• Check that the antenna (aerial) is connected securely. Adjust the antenna (aerial) or connect an external antenna (aerial) if necessary.</li> <li>• The signal strength of the stations is too weak (when tuning in with automatic tuning). Use direct tuning.</li> </ul>
The disc does not play.	<ul style="list-style-type: none"> <li>• You are attempting to play a disc with a format that cannot be played by this system (page 64).</li> <li>• The region code on the BD/DVD does not match the system.</li> <li>• Moisture has condensed inside the unit and may cause damage to the lenses. Remove the disc and leave the unit turned on for about half an hour.</li> <li>• The system cannot play a recorded disc that is not correctly finalized (page 64).</li> </ul>
File names are not displayed correctly.	<ul style="list-style-type: none"> <li>• The system can only display ISO 8859-1-compliant character formats. Other character formats may be displayed differently.</li> <li>• Depending on the writing software used, the input characters may be displayed differently.</li> </ul>
A disc does not start playing from the beginning.	<ul style="list-style-type: none"> <li>• Resume play has been selected. Press OPTIONS and select [Play from beginning], then press .</li> <li>• The title or BD/DVD menu automatically appears on the TV screen.</li> </ul>

Symptom	Problems and solutions
Playback does not start from the resume point where you last stopped playing.	<ul style="list-style-type: none"> <li>• The resume point may be cleared from memory depending on the disc when               <ul style="list-style-type: none"> <li>– you eject the disc.</li> <li>– you disconnect the USB device.</li> <li>– you play other content.</li> <li>– you turn off the unit.</li> </ul> </li> </ul>
The system starts playing the disc automatically.	<ul style="list-style-type: none"> <li>• The BD/DVD features an auto playback function.</li> </ul>
Playback stops automatically.	<ul style="list-style-type: none"> <li>• Some discs may contain an auto pause signal. While playing such a disc, the system stops playback at the auto pause signal.</li> </ul>
You cannot perform some functions such as stop or search.	<ul style="list-style-type: none"> <li>• Depending on the disc, you may not be able to perform some of the operations. Refer to the operating instructions supplied with the disc.</li> </ul>
Messages do not appear on the TV screen in the language you want.	<ul style="list-style-type: none"> <li>• In the Setup Display, select the desired language for the on-screen display in [OSD] in [System Settings] (page 53).</li> </ul>
The language for the sound track/subtitle or angles cannot be changed.	<ul style="list-style-type: none"> <li>• Try using the BD's or DVD's menu.</li> <li>• Multi-lingual tracks/subtitles or multi-angles are not recorded on the BD or DVD being played.</li> <li>• The BD or DVD prohibits the changing of the language for the sound track/subtitle or angles.</li> </ul>
The disc does not eject and you cannot remove the disc even after you press  .	<ul style="list-style-type: none"> <li>• Try the following: ① Press and hold  and  on the unit for more than 5 seconds to eject the disc. ② Remove the disc. ③ Disconnect the AC power cord (mains lead) from the wall outlet (mains), then reconnect after several minutes.</li> </ul>
A disc cannot be ejected and "LOCKED" appears in the front panel display.	<ul style="list-style-type: none"> <li>• Contact your Sony dealer or local authorized Sony service facility.</li> </ul>
The Control for HDMI function does not work.	<ul style="list-style-type: none"> <li>• Set [Control for HDMI] in [HDMI Settings] of [System Settings] to [On] (page 53).</li> <li>• Make sure that the connected component is compatible with the [Control for HDMI] function.</li> <li>• Check the connected component's setting for the Control for HDMI function. Refer to the operating instructions supplied with the component.</li> <li>• If you change the HDMI connection, connect and disconnect the AC power cord (mains lead), or have a power failure, set [Control for HDMI] in [HDMI Settings] of [System Settings] to [Off], then set [Control for HDMI] to [On] (page 53).</li> <li>• For details, see "Using the Control for HDMI Function for "BRAVIA" Sync" (page 44).</li> </ul>
No sound is output from the system and TV while using the System Audio Control function.	<ul style="list-style-type: none"> <li>• Make sure that the connected TV is compatible with the System Audio Control function.</li> <li>• For details, see "Using the Control for HDMI Function for "BRAVIA" Sync" (page 44).</li> </ul>
Bonus contents or other data that are contained in a BD-ROM cannot be played.	<ul style="list-style-type: none"> <li>• Try the following: ① Remove the disc. ② Turn the system off. ③ Remove and reconnect the USB device (page 34). ④ Turn the system on. ⑤ Insert the BD-ROM with BONUSVIEW/BD-LIVE.</li> </ul>
The unit does not work and "CHILD LOCK" appears in the front panel display when you press any button on the unit.	<ul style="list-style-type: none"> <li>• Set the child lock function to off (page 47).</li> </ul>
The system menu does not work.	<ul style="list-style-type: none"> <li>• Press HOME on the remote.</li> </ul>

## USB device

Symptom	Problems and solutions
The USB device is not recognized.	<ul style="list-style-type: none"><li>• Try the following: ① Turn the system off. ② Remove and reconnect the USB device. ③ Turn the system on.</li><li>• Make sure that the USB device is securely connected to the  (USB) port.</li><li>• Check if the USB device or a cable is damaged.</li><li>• Check if the USB device is on.</li><li>• If the USB device is connected via a USB hub, disconnect it and connect the USB device directly to the unit.</li></ul>

## BRAVIA Internet Video

Symptom	Problems and solutions
The picture/sound is poor/certain programs display with a loss of detail, especially during fast-motion or dark scenes.	<ul style="list-style-type: none"><li>• Picture/sound quality may be poor depending on Internet content providers.</li><li>• Picture/sound quality may be improved by changing the connection speed. Sony recommends a connection speed of at least 2.5 Mbps for standard-definition video and 10 Mbps for high-definition video.</li><li>• Not all videos contain sound.</li></ul>
The picture is small.	<ul style="list-style-type: none"><li>• Press  to zoom in.</li></ul>

## Network connection

Symptom	Problems and solutions
The player cannot connect to the network.	<ul style="list-style-type: none"><li>• Check the network connection (page 25) and the network settings (page 54).</li></ul>
You cannot connect your PC to the Internet after [Wi-Fi Protected Setup (WPS)] is performed.	<ul style="list-style-type: none"><li>• The wireless settings of the router may change automatically if you use the Wi-Fi Protected Setup function before adjusting the settings of the router. In this case, change the wireless settings of your PC accordingly.</li></ul>
You cannot connect the system to your wireless LAN router.	<ul style="list-style-type: none"><li>• Check if the wireless LAN router is on.</li><li>• Depending on the usage environment, including the wall material, radio wave reception conditions, or obstacles between the system and the wireless LAN router, the possible communication distance may be shortened. Move the system and the wireless LAN router closer to each other.</li><li>• Devices that use a 2.4 GHz frequency band, such as a microwave, Bluetooth, or digital cordless device, may interrupt the communication. Move the unit away from such devices, or turn off such devices.</li></ul>
The desired wireless router is not detected even if [Scan] is performed.	<ul style="list-style-type: none"><li>• Press RETURN to return to the previous screen, and try [Scan] again. If the desired wireless router is still not detected, press RETURN to select [Manual registration].</li></ul>
The message [A new software version has been found on the network. Perform update under "Network Update."] appears on the screen when turning the system on.	<ul style="list-style-type: none"><li>• See [Network Update] (page 49) to update the system to a newer software version.</li></ul>

## USB Wireless LAN Adapter

Symptom	Problems and solutions
The system cannot connect to the network or the network connection is unstable.	<ul style="list-style-type: none"><li>• The distance between the unit and the wireless LAN router is too far (page 25).</li><li>• Change the USB Wireless LAN Adapter position.</li></ul>

### Other

Symptom	Problems and solutions
“Exxxx” appears in the front panel display.	<ul style="list-style-type: none"><li>• Contact your nearest Sony dealer or local authorized Sony service facility and give the error code.</li></ul>

# Playable Discs

<b>Blu-ray Disc</b>	BD-ROM <sup>1)</sup> BD-R/BD-RE <sup>2)</sup>
<b>DVD<sup>3)</sup></b>	DVD-ROM DVD-R/DVD-RW DVD+R/DVD+RW
<b>CD<sup>3)</sup></b>	CD-DA (Music CD) CD-ROM CD-R/CD-RW Super Audio CD

<sup>1)</sup>Since the Blu-ray Disc specifications are new and evolving, some discs may not be playable depending on the disc type and the version. Also, the audio output differs depending on the source, connected output jack, and selected audio settings.

<sup>2)</sup>BD-RE: Ver.2.1

BD-R: Ver.1.1, 1.2, 1.3 including organic pigment type BD-R (LTH type)

BD-Rs recorded on a PC cannot be played if postscripts are recordable.

<sup>3)</sup>A CD or DVD disc will not play if it has not been correctly finalized. For more information, refer to the operating instructions supplied with the recording device.

## Discs that cannot be played

- BDs with cartridge
- DVD-RAMs
- HD DVDs
- DVD Audio discs
- PHOTO CDs
- Data part of CD-Extras
- VCDs/Super VCDs
- Audio material side on DualDiscs
- A disc recorded in a color system other than NTSC, such as PAL (this system conforms to the NTSC color system).

## Notes on discs

This product is designed to playback discs that conform to the Compact Disc (CD) standard. DualDiscs and some music discs encoded with copyright protection technologies do not conform to the Compact Disc (CD) standard. Therefore, these discs may not be compatible with this product.

## Note on playback operations of a BD/DVD

Some playback operations of a BD/DVD may be intentionally set by software producers. Since this system plays a BD/DVD according to the disc contents the software producers designed, some playback features may not be available.

## Note about double-layer BDs/DVDs

The playback picture and sound may be momentarily interrupted when the layers switch.

## Region code (BD-ROM/DVD VIDEO only)

Your system has a region code printed on the rear of the unit and will only play a BD-ROM/DVD VIDEO (playback only) labeled with identical region codes or .



# Playable Types of Files

## Video<sup>6)</sup>

File format	Extensions
MPEG-1 Video/PS <sup>1)4)</sup>	“.mpg,” “.mpeg,” “.m2ts,”
MPEG-2 Video/PS, TS <sup>1)5)</sup>	“.mts”
MPEG4/AVC <sup>1)4)</sup>	“.mkv,” “.mp4,” “.m4v,” “.m2ts,” “.mts”
WMV9 <sup>1)4)</sup>	“.wmv,” “.asf”
AVCHD	2)4)

## Music

File format	Extensions
MP3 (MPEG-1 Audio Layer III)	“.mp3”
AAC <sup>1)3)4)</sup>	“.m4a”
WMA9 Standard <sup>1)3)</sup>	“.wma”
LPCM	“.wav”

## Photo<sup>6)</sup>

File format	Extensions
JPEG	“.jpg,” “.jpeg,” “.jpe”

<sup>1)</sup>The system does not play files encoded with DRM.

<sup>2)</sup>The system plays AVCHD-format files that are recorded via a digital video camera, etc. To watch AVCHD-format files, the disc with AVCHD-format files on it must be finalized.

<sup>3)</sup>The system does not play files encoded with Lossless, etc.

<sup>4)</sup>The system does not play these files via the DLNA function.

<sup>5)</sup>The system plays SD resolution only via the DLNA function.

<sup>6)</sup>The system does not play these files via the DLNA renderer function.

### Note

- Some files may not play depending on the format, the encoding, or recording condition.
- Some files edited on a PC may not play.
- The system can recognize the following files or folders in BDs, DVDs, CDs and USB devices:
  - up to folders in the 5th tree
  - up to 500 files in a single tree
- Some USB devices may not work with this system.
- The system can recognize Mass Storage Class (MSC) devices (such as flash memory or an HDD) that are

FAT-compatible and non-partitioned, Still Image Capture Devices (SICDs) and 101-key keyboards. 101-key keyboards can be recognized by the left  (USB) port only.

- To avoid data corruption or damage to USB memory or other devices, turn the system off before connecting or removing USB memory or other devices.
- The system may not play high bit rate video files from a DATA CD smoothly. It is recommended to play high bit rate video files using a DATA DVD.

# Supported Audio Formats

Audio formats supported by this system are as follows.

Function	Format							
	LPCM 2ch	LPCM 5.1ch, LPCM 7.1ch	Dolby Digital	Dolby TrueHD, Dolby Digital Plus	DTS	DTS-ES Discrete 6.1, DTS-ES Matrix 6.1, DTS96/24	DTS-HD High Resolution Audio	DTS-HD Master Audio
"BD/DVD"	○	○	○	○	○	○	○	○
"SAT/CABLE" "TV"	○	-	○	-	○	-	-	-

○: Supported format.

-: Unsupported format.

# Specifications

## Amplifier Section

POWER OUTPUT AND TOTAL HARMONIC

DISTORTION:

(FTC)

Front L + Front R: With 4 ohms loads, both channels driven, from 200 - 20,000 Hz; rated 40 watts per channel minimum RMS power, with no more than 1% total harmonic distortion from 250 milli watts to rated output.

POWER OUTPUT (reference)

Front L/Front R: 115 W (per channel at 4 ohms, 1 kHz)

Subwoofer: 120 W (at 4 ohms, 100 Hz)

Inputs (Analog)

AUDIO (IN) Sensitivity: 450/250 mV

Inputs (Digital)

SAT/CABLE (DIGITAL IN OPTICAL),

TV (DIGITAL IN OPTICAL)

Supported formats: LPCM 2CH (up to 48 kHz), Dolby Digital, DTS

## Video Section

Outputs VIDEO OUT: 1 Vp-p 75 ohms  
HDMI OUT: Type A (19 pin)

## BD/DVD/Super Audio CD/CD System

Signal format system NTSC

## USB Section

⚡ (USB) port: Type A (For connecting USB memory, memory card reader, digital still camera, and digital video camera)

Maximum current: 500 mA

## LAN Section

LAN (100) terminal 100BASE-TX Terminal

## Tuner Section

System PLL quartz-locked digital synthesizer

FM tuner section

Tuning range 87.5 MHz - 108.0 MHz (100 kHz step)

Antenna (aerial) FM wire antenna (aerial)

Antenna (aerial) terminals 75 ohms, unbalanced

Intermediate frequency 10.7 MHz

## Speakers

### Front (SS-TSF7)

Speaker system Full range, Acoustic suspension  
Speaker unit (per channel) 40 mm × 70 mm (1 5/8 in × 2 7/8 in), cone type × 2  
Rated impedance 4 ohms  
Dimensions (approx.) 996 mm × 66 mm × 72 mm (39 1/4 in × 2 5/8 in × 2 7/8 in) (w/h/d)  
Mass (approx.) 2.2 kg (4 lb 14 oz)

### Subwoofer (SS-WSF550)

Speaker system Subwoofer, Bass reflex  
Speaker unit 160 mm (6 3/8 in) cone type  
Rated impedance 4 ohms  
Dimensions (approx.) 265 mm × 335 mm × 265 mm (10 1/2 in × 13 1/4 in × 10 1/2 in) (w/h/d)  
Mass (approx.) 6.5 kg (14 lb 6 oz)

## General

Power requirements 120 V AC, 60 Hz

Power consumption On: 90 W

Standby: 0.3 W (at the Power Saving mode)

Dimensions (approx.) 452 mm × 198 mm × 119 mm (17 7/8 in × 7 7/8 in × 4 3/4 in) (w/h/d) incl. projecting parts

Mass (approx.) 5.0 kg (11 lb 1 oz)

## USB Wireless LAN Adapter (UWA-BR100)

Standards Compliance IEEE 802.11a/b/g/n

Host Interface USB 2.0

Security 64/128 bit: WEP, WPA/WPA2, WPS

Frequency and Channel\* 2.4 GHz - 2.4835 GHz [CH1 - 11]

5.15 GHz - 5.25 GHz [CH36 - 48]

5.25 GHz - 5.35 GHz [CH52 - 64]

5.47 GHz - 5.725 GHz [CH100 - 140]

5.725 GHz - 5.85 GHz [CH149 - 165]

Data Rate\*\* 802.11a/g: 54, 48, 36, 24, 18, 12, 9 and 6 Mbps

802.11b: 11, 5.5, 2 and 1 Mbps

802.11n: up to 300 Mbps (40 MHz/spatial streams: 2)

Power consumption Tx: up to 500 mA

Dimensions (approx.)	96 mm × 14 mm × 27 mm (3 7/8 in × 9/16 in × 1 1/8 in) (w/h/d)
Mass (approx.)	27 g (1 oz)

\* The frequency and channel differ depending on the area.

\*\* The transmission speed differs depending on the distance and number of obstructions between the transmission products, the configuration of products, the radio wave conditions, the line traffic, and the products that you use. The transmission may also be cut off depending on the radio wave conditions. The standard values of the transmission speed are the theoretical maximum values for the wireless standards. They are not the actual speeds of data transmission.

Design and specifications are subject to change without notice.

- Standby power consumption 0.3 W.
- Halogenated flame retardants are not used in the certain printed wiring boards.
- Over 85% power efficiency of amplifier block is achieved with the full digital amplifier, S-Master.

# Language Code List

The language spellings conform to the ISO 639: 1988 (E/F) standard.

Code	Language	Code	Language	Code	Language	Code	Language
1027	Afar	1183	Irish	1347	Maori	1507	Samoaan
1028	Abkhazian	1186	Scots Gaelic	1349	Macedonian	1508	Shona
1032	Afrikaans	1194	Galician	1350	Malayalam	1509	Somali
1039	Amharic	1196	Guarani	1352	Mongolian	1511	Albanian
1044	Arabic	1203	Gujarati	1353	Moldavian	1512	Serbian
1045	Assamese	1209	Hausa	1356	Marathi	1513	Siswati
1051	Aymara	1217	Hindi	1357	Malay	1514	Sesotho
1052	Azerbaijani	1226	Croatian	1358	Maltese	1515	Sundanese
1053	Bashkir	1229	Hungarian	1363	Burmese	1516	Swedish
1057	Byelorussian	1233	Armenian	1365	Nauru	1517	Swahili
1059	Bulgarian	1235	Interlingua	1369	Nepali	1521	Tamil
1060	Bihari	1239	Interlingue	1376	Dutch	1525	Telugu
1061	Bislama	1245	Inupiak	1379	Norwegian	1527	Tajik
1066	Bengali; Bangla	1248	Indonesian	1393	Occitan	1528	Thai
		1253	Icelandic	1403	(Afan)Oromo	1529	Tigrinya
1067	Tibetan	1254	Italian	1408	Oriya	1531	Turkmen
1070	Breton	1257	Hebrew	1417	Punjabi	1532	Tagalog
1079	Catalan	1261	Japanese	1428	Polish	1534	Setswana
1093	Corsican	1269	Yiddish	1435	Pashto; Pushto	1535	Tonga
1097	Czech	1283	Javanese	1436	Portuguese	1538	Turkish
1103	Welsh	1287	Georgian	1463	Quechua	1539	Tsonga
1105	Danish	1297	Kazakh	1481	Rhaeto-Romance	1540	Tatar
1109	German	1298	Greenlandic			1543	Twì
1130	Bhutani	1299	Cambodian	1482	Kirundi	1557	Ukrainian
1142	Greek	1300	Kannada	1483	Romanian	1564	Urdu
1144	English	1301	Korean	1489	Russian	1572	Uzbek
1145	Esperanto	1305	Kashmiri	1491	Kinyarwanda	1581	Vietnamese
1149	Spanish	1307	Kurdish	1495	Sanskrit	1587	Volapük
1150	Estonian	1311	Kirghiz	1498	Sindhi	1613	Wolof
1151	Basque	1313	Latin	1501	Sangho	1632	Xhosa
1157	Persian	1326	Lingala	1502	Serbo-Croatian	1665	Yoruba
1165	Finnish	1327	Laothian	1503	Singhalese	1684	Chinese
1166	Fiji	1332	Lithuanian	1505	Slovak	1697	Zulu
1171	Faroese	1334	Latvian; Lettish	1506	Slovenian		
1174	French	1345	Malagasy				
1181	Frisian					1703	Not specified

Additional Information

## Parental Control/Area Code List

Code	Area	Code	Area	Code	Area	Code	Area
2044	Argentina	2109	Germany	2376	Netherlands	2543	Taiwan
2047	Australia	2200	Greece	2390	New Zealand	2528	Thailand
2046	Austria	2219	Hong Kong	2379	Norway	2184	United Kingdom
2057	Belgium	2248	India	2427	Pakistan		
2070	Brazil	2238	Indonesia	2424	Philippines		
2090	Chile	2239	Ireland	2428	Poland		
2092	China	2254	Italy	2436	Portugal		
2093	Colombia	2276	Japan	2489	Russia		
2115	Denmark	2304	Korea	2501	Singapore		
2165	Finland	2333	Luxembourg	2149	Spain		
2174	France	2363	Malaysia	2499	Sweden		
		2362	Mexico	2086	Switzerland		

---

# Glossary

## **AVCHD**

The AVCHD format is a high-definition digital video camera format used to record SD (standard definition) or HD (high definition) signals of either the 1080i specification\* or the 720p specification\*\* on DVDs, using efficient data compression coding technology. The MPEG-4 AVC/H.264 format is adopted to compress video data, and the Dolby Digital or Linear PCM system is used to compress audio data. The MPEG-4 AVC/H.264 format is capable of compressing images at higher efficiency than that of the conventional image compression format. The MPEG-4 AVC/H.264 format enables a high definition (HD) video signal shot on a digital video camera recorder to be recorded on DVD discs in the same way as it would be for a standard definition (SD) television signal.

\* A high definition specification that utilizes 1080 effective scanning lines and the interlace format.

\*\* A high definition specification that utilizes 720 effective scanning lines and the progressive format.

## **BD-J application**

The BD-ROM format supports Java for interactive functions. “BD-J” offers content providers almost unlimited functionality when creating interactive BD-ROM titles.

## **BD-R**

BD-R (Blu-ray Disc Recordable) is a recordable, write-once Blu-ray Disc, available in the same capacities as the BD below. Since contents can be recorded and cannot be overwritten, a BD-R can be used to archive valuable data or store and distribute video material.

## **BD-RE**

BD-RE (Blu-ray Disc Rewritable) is a recordable and rewritable Blu-ray Disc, available in the same capacities as the BD below. The re-recordable feature makes extensive editing and time-shifting applications possible.

## **BD-ROM**

BD-ROMs (Blu-ray Disc Read-Only Memory) are commercially produced discs and are available in the same capacities as the BD below. Other than conventional movie and video contents, these discs have enhanced features such as interactive content, menu operations using pop-up menus, selection of subtitle display, and slideshow. Although a BD-ROM may contain any form of data, most BD-ROM discs will contain movies in High Definition format, for playback on Blu-ray Disc/DVD players.

## **Blu-ray Disc (BD)**

A disc format developed for recording/playing high-definition (HD) video (for HDTV, etc.), and for storing large amounts of data. A single layer Blu-ray Disc holds up to 25 GB, and a dual-layer Blu-ray Disc holds up to 50 GB of data.

## **Dolby Digital**

In this format, the surround speakers output stereo sound with an expanded frequency range, and a subwoofer channel for deep bass is independently provided. This format is also called “5.1” with the subwoofer channel designed as the 0.1 channel (since it functions only when a deep bass effect is needed). All six channels in this format are recorded separately for superior channel separation. Furthermore, since all the signals are processed digitally, less signal degradation occurs.

## **Dolby Digital Plus**

Developed as an extension to Dolby Digital, the audio coding technology supports 7.1 multi-channel surround sound.

## **Dolby TrueHD**

Dolby TrueHD is a lossless coding technology that supports up to 8 channels of multi-channel surround sound for the next generation of optical discs. The reproduced sound is true to the original source bit-for-bit.

**DTS**

Digital audio compression technology developed by DTS, Inc. This technology conforms to 5.1-channel surround. This format includes a stereo rear channel and a discrete subwoofer channel. DTS provides the same 5.1 discrete channels of high quality digital audio. The good channel separation is realized due to the all channel data being recorded discretely and processed in digitally.

**DTS-HD High Resolution Audio**

Developed as an extension to DTS Digital Surround format. It supports a maximum sampling frequency of 96 kHz, and 7.1 multi-channel surround.

DTS-HD High Resolution Audio has a maximum transmission rate of 6 Mbps, with lossy compression.

**DTS-HD Master Audio**

DTS-HD Master Audio has a maximum transmission rate of 24.5 Mbps, and uses lossless compression, and DTS-HD Master Audio corresponds to a maximum sampling frequency of 192 kHz, and maximum of 7.1ch.

**HDMI (High-Definition Multimedia Interface)**

HDMI is an interface that supports both video and audio on a single digital connection, allowing you to enjoy high quality digital picture and sound. The HDMI specification supports HDCP (High-bandwidth Digital Content Protection), a copy protection technology that incorporates coding technology for digital video signals.

**Interlace format (Interlaced scanning)**

The Interlace format is the NTSC standard method for displaying TV images at 30 frames per second. Each frame is scanned twice - alternately between the even numbered scanning lines and then odd numbered scanning lines, at 60 times per second.

**LTH (Low to High)**

LTH is a recording system that supports organic pigment type BD-R.

**Parental Control**

A function of the BD/DVD to limit playback of the disc by the age of the users according to the limitation level in each country. The limitation varies from disc to disc; when it is activated, playback is completely prohibited, violent scenes are skipped or replaced with other scenes and so on.

**PhotoTV HD**

“PhotoTV HD” allows for highly-detailed pictures, and photo-like expression of subtle textures and colors. By connecting Sony “PhotoTV HD” compatible devices using an HDMI cable, a whole new world of photos can be enjoyed in breathtaking Full HD quality. For instance, the delicate texture of the human skin, flowers, sand and waves can now be displayed on a large screen in beautiful photo-like quality.

**Pop-up menu**

An enhanced menu operation available on BD-ROMs. The pop-up menu appears when POP UP/MENU is pressed during playback, and can be operated while playback is in progress.

**Progressive format (sequential scanning)**

In contrast to the Interlace format, the progressive format can reproduce 50 - 60 frames per second by reproducing all scanning lines (525 lines for the NTSC system). The overall picture quality increases and still images, text and horizontal lines appear sharper. This format is compatible with the 525 or 625 progressive format.

**24p True Cinema**

Movies shot with a film camera consist of 24 frames per second.

Since conventional televisions (both CRT and flat panels) display frames either at 1/60 or 1/50 second intervals, the 24 frames do not appear at an even pace.

When connected to a TV with 24p capabilities, the player displays each frame at 1/24 second intervals — the same interval originally shot with the film camera, thus faithfully reproducing the original cinema image.

# Index

## Numerics

24p True Cinema 71  
3D 33  
3D Output Setting 50

## A

A/V SYNC 39  
ARC 22  
Attenuate - AUDIO 51  
Audio 52  
Audio DRC 51  
Audio Output 51  
Audio Return Channel 22, 53  
Audio Settings 51  
Auto Display 54  
Auto Standby 54  
AVCHD 70

## B

BD Audio MIX Setting 51  
BD Data Jack Selection 52  
BD Hybrid Disc Playback  
Layer 52  
BD Internet Connection 52  
BD Parental Control 52  
BD Remote Device  
Registration 55  
BD/DVD Menu 52  
BD/DVD Viewing Settings 52  
BD/DVD-ROM 1080/24p  
Output 50  
BD-LIVE 33  
BD-R 70  
BD-RE 70  
Blu-ray Disc 70  
BONUSVIEW 33  
BRAVIA Internet Video 35

## C

CD 64  
Child Lock 47  
Cinema Conversion Mode 50  
Connection Server Settings 54  
Control for HDMI 44, 53

## D

Dimmer 53  
DLNA 36, 54  
Dolby Digital 40, 70  
Dolby Digital Plus 70  
Dolby TrueHD 70

DTS 40, 71  
DTS Neo:6 51  
DTS-HD 71  
DVD 64  
DVD Aspect Ratio 50  
DVD Parental Control 52

## E

Easy Setup 29, 55

## F

FM MODE 42  
Front panel display 11

## G

Gracenote Settings 54

## H

HDMI  
YCbCr/RGB (HDMI) 50  
HDMI (High-Definition  
Multimedia Interface) 71  
HDMI Deep Color Output 50  
HDMI Settings 53

## I

Illumination Mode 47  
Initialize Personal Information  
55  
Interlace format 71  
Internal memory 33  
Internet content 35  
Internet Settings 54  
Internet Video Parental Control  
53  
Internet Video Unrated 53

## L

Language Code List 69  
LTH 71

## M

Multiplex broadcast sound 41  
Music Settings 53

## N

Network Connection  
Diagnostics 54  
Network Settings 54  
Network Update 49

## O

OSD 53  
Output Video Format 50

## P

Parental Control 71  
Parental Control Area Code 52  
Parental Control Settings 52  
Party 36  
Party Auto Start 55  
Password 52  
Pause Mode 50  
PhotoTV HD 71  
Play information 33  
Playable discs 64  
Progressive format 71

## Q

Quick Start Mode 53

## R

Region code 64  
Registered BD Remote Devices  
55  
Remote control 12  
Renderer Access Control 54  
Renderer Options 54  
Reset to Factory Default  
Settings 55  
Resetting 55

## S

Screen Format 50  
Screen Saver 54  
Screen Settings 50  
SLEEP 47  
Slideshow 38  
Software Update Notification  
54  
Sound Effect 51  
Speaker Settings 46, 51  
Distance 46  
Level 47  
Subtitle 52  
Super Audio CD Playback  
Channel 53  
Super Audio CD Playback  
Layer 53  
System Information 54  
SYSTEM MENU 31, 39  
System Settings 53



## **T**

TV Screen Size Setting for 3D

50

TV Type 50

## **U**

Unit 8

Update 49

USB 34

## **V**

Volume Limit 53

## **W**

WEP 26

WPA2-PSK (AES) 26

WPA2-PSK (TKIP) 26

WPA-PSK (AES) 26

WPA-PSK (TKIP) 26

## **Y**

YCbCr/RGB (HDMI) 50





The software of this system may be updated in the future. To find out details on any available updates, please visit: <http://www.sony.com/bluraysupport/>

**HDMI**

**DVD**  
VIDEO

POWERED BY  
  
gracenote.

**BD LIVE™**

  
SUPER AUDIO CD

**COMPACT**  
**disc**  
DIGITAL AUDIO

**DOLBY**  
**TRUEHD**

 **dts-HD™**  
Master Audio

  
**Java**  
POWERED

<http://www.sony.net/>

