

Home Theatre System

Operating Instructions

HT-SF100

HT-SS100

WARNING

To reduce the risk of fire or electric shock, do not expose this apparatus to rain or moisture.

To reduce the risk of fire, do not cover the ventilation opening of the apparatus with newspapers, tablecloths, curtain, etc.

Do not place the naked flame sources such as lighted candles on the apparatus.

To reduce the risk of fire or electric shock, do not expose this apparatus to dripping or splashing, and do not place objects filled with liquids, such as vases, on the apparatus.

Do not install the appliance in a confined space, such as a bookcase or built-in cabinet.

As the main plug is used to disconnect the unit from the mains, connect the unit to an easily accessible AC outlet. Should you notice an abnormality in the unit, disconnect the main plug from the AC outlet immediately.

Do not expose batteries or apparatus with battery-installed to excessive heat such as sunshine, fire or the like.

To prevent injury, this apparatus must be securely attached to the floor/wall in accordance with the installation instructions.

For customers in Europe



Disposal of Old Electrical & Electronic Equipment (Applicable in the European Union and other European countries with separate collection systems)

This symbol on the product or on its packaging indicates that this product shall not be treated as household waste. Instead it shall be handed over to the applicable collection point for the recycling of electrical and electronic equipment. By ensuring this product is disposed of correctly, you will help prevent potential negative consequences for the environment and human health, which could otherwise be caused by inappropriate waste handling of this product. The recycling of materials will help to conserve natural resources. For more detailed information about recycling of this product, please contact your local Civic Office, your household waste disposal service or the shop where you purchased the product.



Disposal of waste batteries (applicable in the European Union and other European countries with separate collection systems)

This symbol on the battery or on the packaging indicates that the battery provided with this product shall not be treated as household waste.

On certain batteries this symbol might be used in combination with a chemical symbol. The chemical symbols for mercury (Hg) or lead (Pb) are added if the battery contains more than 0.0005% mercury or 0.004% lead.

By ensuring these batteries are disposed of correctly, you will help prevent potentially negative consequences for the environment and human health which could otherwise be caused by inappropriate waste handling of the battery. The recycling of the materials will help to conserve natural resources.

In case of products that for safety, performance or data integrity reasons require a permanent connection with an incorporated battery, this battery should be replaced by qualified service staff only. To ensure that the battery will be treated properly, hand over the product at end-of-life to the applicable collection point for the recycling of electrical and electronic equipment.

For all other batteries, please view the section on how to remove the battery from the product safely. Hand the battery over to the applicable collection point for the recycling of waste batteries.

For more detailed information about recycling of this product or battery, please contact your local Civic Office, your household waste disposal service or the shop where you purchased the product.

Notice for the customer in the countries applying EU Directives

The manufacturer of this product is Sony Corporation, 1-7-1 Konan Minato-ku Tokyo, 108-0075 Japan. The Authorized Representative for EMC and product safety is Sony Deutschland GmbH, Hedelfinger Strasse 61, 70327 Stuttgart, Germany. For any service or guarantee matters please refer to the addresses given in separate service or guarantee documents.

About This Manual

- The instructions in this manual are for model HT-SF100 and HT-SS100. In this manual, models of area code CEL is used for illustration purposes unless stated otherwise. Any difference in operation is clearly indicated in the text, for example, “Models of area code CEK only”.

The HT-SF100 consists of:

- Receiver STR-KS100
- Speaker system^{a)}
 - Front speaker SS-MSP36F
 - Center speaker SS-CNP36
 - Surround speaker SS-SRP36F
 - Subwoofer SS-WP36

The HT-SS100 consists of:

- Receiver STR-KS100
- Speaker system^{a)}
 - Front speaker SS-MSP36S
 - Center speaker SS-CNP36
 - Surround speaker SS-SRP36S
 - Subwoofer SS-WP36

^{a)}Be sure to use only the supplied speakers.

- The instructions in this manual describe the controls on the supplied remote. You can also use the controls on the receiver if they have the same or similar names as those on the remote.

This receiver incorporates Dolby* Digital and Pro Logic Surround and the DTS** Digital Surround System.

- * Manufactured under license from Dolby Laboratories. Dolby, Pro Logic, and the double-D symbol are trademarks of Dolby Laboratories.
- ** Manufactured under license under U.S. Patent #’s: 5,451,942; 5,956,674; 5,974,380; 5,978,762; 6,487,535 & other U.S. and worldwide patents issued & pending. DTS and DTS Digital Surround are registered trademarks and the DTS logos and Symbol are trademarks of DTS, Inc. © 1996-2008 DTS, Inc. All Rights Reserved.

This receiver incorporates High-Definition Multimedia Interface (HDMI™) technology. HDMI, the HDMI logo and High-Definition Multimedia Interface are trademarks or registered trademarks of HDMI Licensing LLC.

“x.v.Colour” and “x.v.Colour” logo are trademarks of Sony Corporation.

“BRAVIA” and BRAVIA are trademarks of Sony Corporation.

About area codes

The area code of the receiver you purchased is shown on the lower portion of the rear panel (see the illustration below).

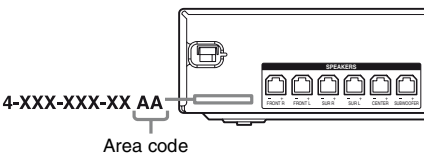

Any differences in operation, according to the area code, are clearly indicated in the text, for example, “Models of area code AA only”.

Table of Contents

Description and location of parts.....5

Getting Started

1: Installing the speakers	12
2: Connecting the speakers	15
3: Connecting the TV	16
4: Connecting the audio/video components.....	17
5: Connecting the antennas.....	21
6: Preparing the receiver and the remote	21
7: Calibrating the appropriate settings automatically (AUTO CALIBRATION).....	23
8: Adjusting the speaker levels (TEST TONE).....	27

Playback

Selecting a component.....	28
Enjoying sound/images from the components connected to the receiver.....	29

Amplifier Operations

Navigating through menus.....	32
Settings for the HDMI (SET HDMI menu).....	35
Settings for the Auto Calibration (A.CAL menu).....	35
Settings for the speaker (SP SETUP menu).....	36
Adjusting the level (LEVEL menu).....	37
Adjusting the tone (TONE menu)	37
Custom settings (CUSTOM menu)	38

Enjoying Surround Sound

Selecting the sound field.....	39
--------------------------------	----

Tuner Operations

Listening to FM/AM radio.....	40
Presetting radio stations	41
Using the Radio Data System (RDS).....	43
(Models of area code CEL, CEK only)	

“BRAVIA” Sync Features

What is “BRAVIA” Sync?.....	44
Preparing for the “BRAVIA” Sync	45
Playing back components with one-touch operation (One-Touch Play).....	46
Enjoying the TV sound from the speakers connected to the receiver (System Audio Control).....	47
Turning off the receiver with the TV (System Power Off)	48
Using the Power Saving function (Power Save).....	48

Other Operations

Changing the brightness of the display (DIMMER)	49
Changing the display setting (DISPLAY)...	50
Using the Sleep Timer (SLEEP)	50
Switching the audio input mode (IN MODE).....	51

Using the Remote

Changing the input button assignments	51
---	----

Additional Information

Glossary	53
Precautions.....	54
Troubleshooting	56
Specifications.....	60
Index	63

Description and location of parts

Receiver

Front view

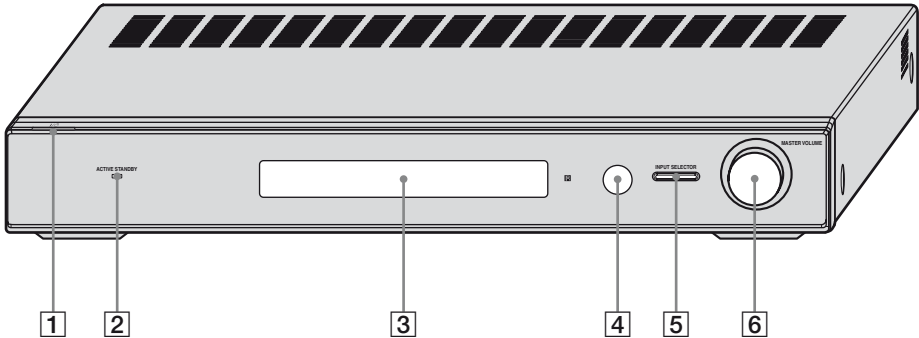

Name	Function
1 I/O (on/standby)	Press to turn the receiver on or off (page 22, 29, 52).
2 ACTIVE STANDBY lamp	Lights up in amber when the Control for HDMI is set to on and the receiver is on standby mode. Note If the ACTIVE STANDBY lamp is flashing, see page 59.
3 Display	The current status of the selected component or a list of selectable items appears here (page 6).
4 Remote sensor	Receives signals from remote commander.
5 INPUT SELECTOR	Press to select the input source to playback (page 28, 30, 31, 40, 41, 42).
6 MASTER VOLUME	Turn to adjust the volume level of all speakers at the same time (page 29, 30, 56).

About the indicators on the display

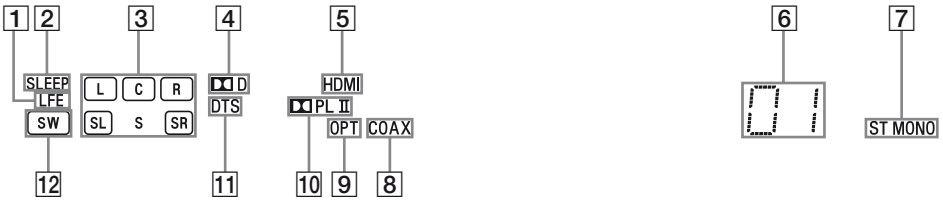

Name	Function
1 LFE	Lights up when the disc being played back contains an LFE (Low Frequency Effect) channel and the LFE channel signal is actually being reproduced.
2 SLEEP	Lights up when the sleep timer is activated (page 50).
3 Playback channel indicators	The letters (L, C, R, etc.) indicate the channels being played back. The boxes around the letters vary to show how the receiver downmixes the source sound. L Front Left R Front Right C Center (monaural) SL Surround Left SR Surround Right S Surround (monaural or the surround components obtained by Pro Logic processing) Example: Recording format (Front/ Surround): 3/2.1 Sound Field: A.F.D. AUTO <div style="text-align: center;"> L C R SW SL SR </div>
4 <input checked="" type="checkbox"/> D	Lights up when receiver is decoding Dolby Digital signals. Note When playing a Dolby Digital format disc, be sure that you have made digital connections.
5 HDMI	Lights up when a playback component is connected to this receiver using an HDMI jack (page 18).

Name	Function
6 Preset station indicators	Lights up when using the receiver to tune in radio stations you have preset. For details on presetting radio stations, see page 41.
7 Tuner indicators	Lights up when using the receiver to tune in radio stations (page 40), etc.
8 COAX	Lights up when the source signal is a digital signal being input through the COAX IN jack.
9 OPT	Lights up when the source signal is a digital signal being input through the OPT IN jack.
10 <input checked="" type="checkbox"/> PL/ <input checked="" type="checkbox"/> PLII	“ <input checked="" type="checkbox"/> PL” lights up when the receiver applies Pro Logic processing to 2 channel signals in order to output the center and surround channel signals. “ <input checked="" type="checkbox"/> PLII” lights up when the Pro Logic II Movie/Music decoder is activated.
11 DTS	Lights up when the receiver is decoding DTS signals. Note When playing a DTS format disc, be sure that you have made digital connections.
12 SW	Lights up when the audio signal is output from the SUBWOOFER jack.

Rear panel

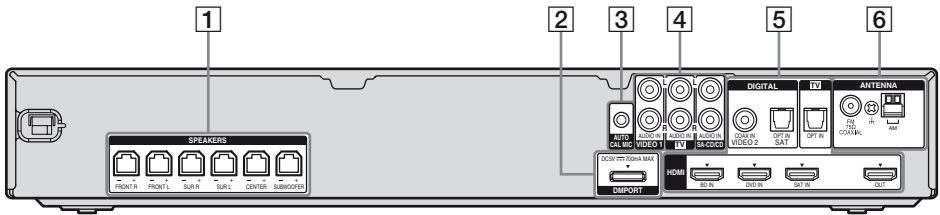

1 SPEAKERS section



Connects to the supplied speakers and subwoofer (page 15).

2 DMPORT



DMPORT jack Connects to a DIGITAL MEDIA PORT adapter (page 17).

3 AUTO CALIBRATION section



AUTO CAL MIC jack Connects to the supplied optimizer microphone for the Auto Calibration function (page 24).

4 AUDIO INPUT section



White (L) AUDIO IN jacks Connects to a Super Audio CD player, CD player, etc. (page 16, 17, 18, 20).



Red (R)

5 DIGITAL INPUT/OUTPUT section



OPT IN jacks Connects to a satellite tuner, etc. The COAX IN jack provides a better sound quality (page 20).



COAX IN jack



HDMI IN/OUT jacks Connects to a DVD player, satellite tuner, or a Blu-ray disc player. The image is output to a TV or a projector while the sound can be output from a TV or/and speakers connected to this receiver (page 18).

6 ANTENNA section



FM ANTENNA jack Connects to the supplied FM wire antenna (page 21).



AM ANTENNA terminals Connects to the supplied AM loop antenna (page 21).

Remote commander

You can use the supplied RM-AAU058 Remote Commander to operate the receiver and to control the Sony audio/video components that the remote is assigned to operate (page 51).

RM-AAU058

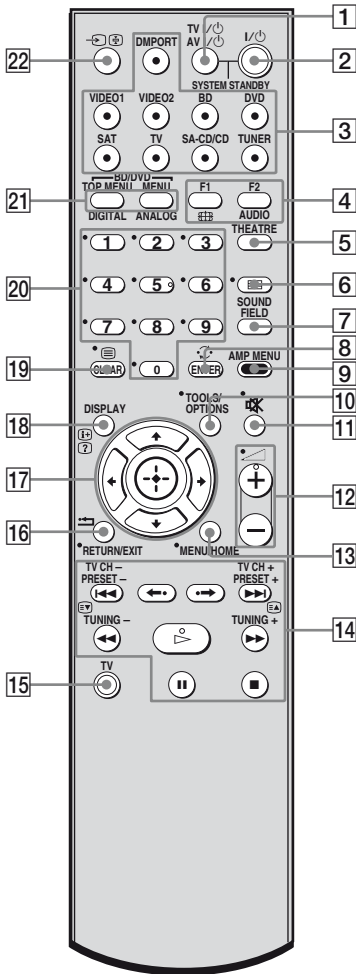

Basic operations

Remote Button	Function
2 I/⏻ (on/standby)	Press to turn the receiver on or off. To turn off all Sony components, press I/⏻ and AV I/⏻ (1) at the same time (SYSTEM STANDBY).

Saving the power in standby mode

When "CONTROL FOR HDMI" is set to "CTRL ON" and "P.SAVE" is set to "SAVE ON" (page 35).

3 Input buttons	Press one of the buttons to select the component you want to use. The buttons are factory assigned to control Sony components. You can change the button assignments following the steps in "Changing the input button assignments" on page 51.
-----------------	---

7 SOUND FIELD	Press to select a sound field.
9 AMP MENU	Press to display the menu of the receiver.



11 Muting	Press to turn off the sound. Press Muting again to restore the sound.
-----------	---

12 +/-	Press to adjust the volume.
17 +, -/⏪/⏩	Press +, -, ⏪ or ⏩ to select the settings. Then, press + to enter the selection.

Tuner operations

Remote Button	Function
8 ENTER	Press to enter the selection.
13 MENU/HOME	Press to display the menu.
14 PRESET +/-	Press to select preset stations.
TUNING +/-	Press to scan a station.
17  , ↑/↓/←/→	Press to select a menu item and enter the selection.
18 DISPLAY	Press to display information during TUNER function.
19 CLEAR	Press to clear a mistake when you input a wrong character.

DMPORT operations

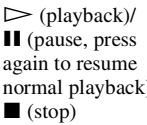
Remote Button	Function
14 	Press to skip the tracks.
	Press to fast reverse or to fast forward.
	Play mode buttons.

To control the component

1 Press one of the input buttons (TV, BD, DVD or SAT) (**3**) to select the component you want to operate.

The component assigned to the selected input button becomes operable.



2 Referring to the following table, press the corresponding button for the operation.

Common operations











Remote Button	Function
1 TV I/⏻ AV I/⏻ (on/standby)	Press to turn on or off the Sony audio/video components that the remote is assigned to operate (page 51). Press I/⏻ (2) and TV I/⏻/AV I/⏻ (1) at the same time to turn off the receiver and other components that the remote is assigned to operate (SYSTEM STANDBY).
8 ENTER	Press to enter the selection.
20 Numeric buttons (number 5*)	Press to select channels and tracks directly.

To control the TV

Press and hold TV (yellow) button (**15**) while pressing the buttons with an yellow dot or yellow printing to control the TV.







Remote Button	Function
4 AUDIO	Press to select the desired audio signal.
 (Screen mode)	Press to change the screen format manually to suit the broadcast.
5 THEATRE	Press to set the optimal picture settings automatically for watching movies, when you connect a Sony TV which is compatible with the THEATRE button. Also, the audio is automatically switched to the audio output of this receiver when you connect the TV and the receiver with HDMI connection, and the Control for HDMI function is set to on.
6  (Guide)	Press to display the guide when you are watching analog and digital channels.
8  (Previous channel)	Press to return to the previous channel watched (for more than five seconds).

continued

Remote Button	Function
10 TOOLS/ OPTIONS	Press to enable you to access various viewing options and change/make adjustments according to the source and screen format.
11  (Muting)	Press to turn off the sound.
12 	Press to adjust the volume.
13 MENU/HOME	Press to allow you to select channels or input sources and change the settings for your TV.
14 TV CH +/- 	In TV mode: Press to select the next (+) or previous (-) channel. In Text mode: Press to select the next () or previous () page.
16  RETURN/ EXIT	Press to return to the previous screen of any displayed menu.
17  , 	Press to select a menu item and enter the selection.
18 DISPLAY	Press to display the TV's information on the TV screen. (Displays the current channel number, etc.)
 (Info/Text reveal)	In digital mode: Press to display brief details of the program currently being watched. In analogue mode: Press to display information such as current channel number and screen format. In Text mode: Press to reveal hidden information (e.g. answers to a quiz).
19  (Text)	Press to display text.
20 Numeric buttons (number 5*)	Press to select channels. Press ENTER () to change channels immediately.
21 ANALOG	Press to change to analog mode.
DIGITAL	Press to change to digital mode.

Remote Button	Function
22  (Input select/ Text hold)	In TV mode: Press to select input. In Analogue Text mode: Press to hold the current page.

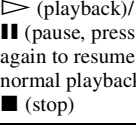
To control the DVD recorder/Blu-ray Disc recorder

Remote Button	Function
4 F1	Press to select the HDD.
F2	Press to select the Blu-ray Disc/DVD.
13 MENU/HOME	Press to display the menu.
14 	Press to skip chapters.
	Press to jump backward while viewing live or recorded programs.
	Press to jump forward while viewing recorded programs.
	Press to skip forward to the next available chapter.
	Press to fast reverse or to fast forward the disc when pressed during playback.
	Play mode buttons.
17  , 	Press to select a menu item and enter the selection.
21 BD/DVD TOP MENU, MENU	Press to display the top menu or disc menu.



To control the DVD player/ Blu-ray Disc player

Remote Button	Function
13 MENU/HOME	Press to display the menu.
14 ◀◀/▶▶	Press to skip chapters.
◀◀	Press to jump backward.
▶▶	Press to jump forward.
◀◀/▶▶	Press to fast reverse or to fast forward the disc when pressed during playback.
▷ (playback)/ ⏸ (pause, press again to resume normal playback)/ ■ (stop)	Play mode buttons.
17  ,	Press to select a menu item and enter the selection.
21 BD/DVD TOP MENU, MENU	Press to display the top menu or disc menu.

To control the HDD/DVD COMBO

Remote Button	Function
4 F1	Press to select the HDD.
F2	Press to select the DVD.
13 MENU/HOME	Press to display the menu.
14 ◀◀/▶▶	Press to specify the previous or next chapter or track.
◀◀	Press to change to replay mode.
▶▶	Press to advance.
◀◀/▶▶	Press to fast reverse or to fast forward the disc when pressed during playback.
▷ (playback)/ ⏸ (pause, press again to resume normal playback)/ ■ (stop)	Play mode buttons.
17  ,	Press to move the highlight (cursor) and select the item.
21 BD/DVD TOP MENU, MENU	Press to display the top menu or disc menu.

To control the SAT

Remote Button	Function
6  (Guide)	Press to display the guide menu.
13 MENU/HOME	Press to display the menu.
17  ,	Press to select a menu item and enter the selection.

* The number 5, ◀ + and ▶ buttons have tactile dots. Use the tactile dots as references when operating the receiver.

Notes

- Some functions explained in this section may not work depending on the model.
- The above explanation is intended to serve as an example only. Therefore, depending on the component, the above operation may not be possible or may operate differently than described.

1: Installing the speakers

This receiver allows you to use a 5.1 channel speaker system. To fully enjoy theater-like multi channel surround sound, be sure to connect all the speakers (two front speakers, a center speaker, and two surround speakers) and a subwoofer (5.1 channel). You can place your speakers as shown below.

- A** Front speaker (left)
- B** Front speaker (right)
- C** Center speaker
- D** Surround speaker (left)
- E** Surround speaker (right)
- F** Subwoofer

HT-SF100 only

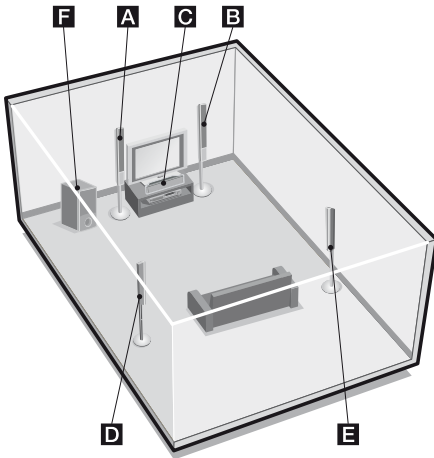

HT-SS100 only

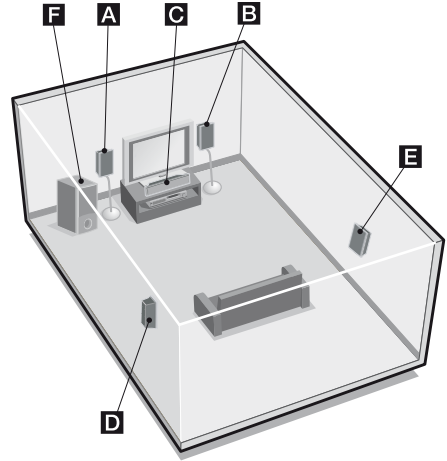

Tip

Since the subwoofer does not emit highly directional signals, you can place it wherever you want.

Installing the speakers on a flat surface

Before you install the speakers and subwoofer, be sure to attach the supplied foot pads to prevent vibration or movement as shown in the illustration below.

Example of HT-SS100 front speaker

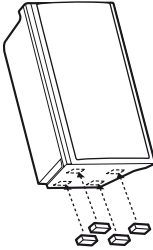

Attach the supplied foot pads to the following speakers.

Model	Speakers
HT-SF100	Center speaker and subwoofer
HT-SS100	All the speakers and subwoofer

Installing the speakers on the speaker stand

For greater flexibility in positioning the speakers, you are recommended to use the speaker stand as below.

Model	Speaker stand
HT-SF100	Supplied. For details, refer to the supplied speaker stand installation guide.
HT-SS100	Optional WS-FV11 or WS-FV10D speaker stand (available only in certain countries). For details, refer to the operating instructions supplied with the speaker stand.

Installing the speakers on the wall

You can install your speakers on the wall.

- 1 Prepare screws (not supplied) that are suitable for the hook on the back of each speaker. See the illustrations below.**

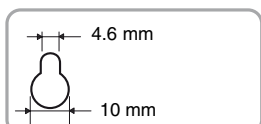
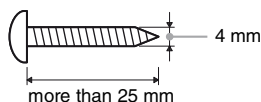

Hook on the back of the speaker

- 2 Fasten the screws to the wall. The screws should protrude 5 mm to 7 mm.**

For the center speaker

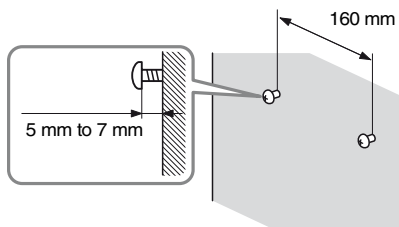

For the front speakers of HT-SF100

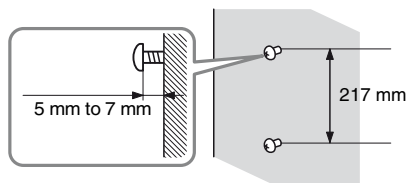

For the surround speakers of HT-SF100

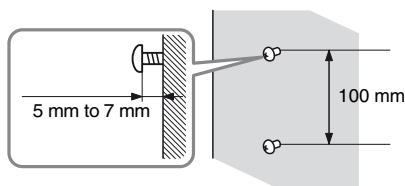

For the front speakers and surround speakers of HT-SS100

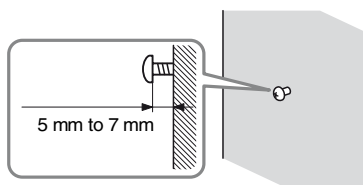

- 3 Hang the speakers on the screws.**

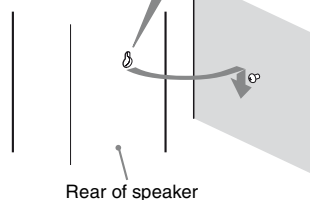
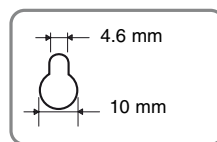

Notes

- Use screws that are suitable for the wall material and strength. As a plaster board wall is especially fragile, attach the screws securely to a beam and fasten them to the wall. Install the speakers on a vertical and flat wall where reinforcement is applied.
- Contact a screw shop or installer regarding the wall material or screws to be used.
- Sony is not responsible for accident or damage caused by improper installation, insufficient wall strength or improper screw installation, natural calamity, etc.
- For HT-SF100, if you install the speakers on the wall, you do not need to attach the supplied speaker stand.

2: Connecting the speakers

Before connecting the cords, be sure to disconnect the AC power cord.

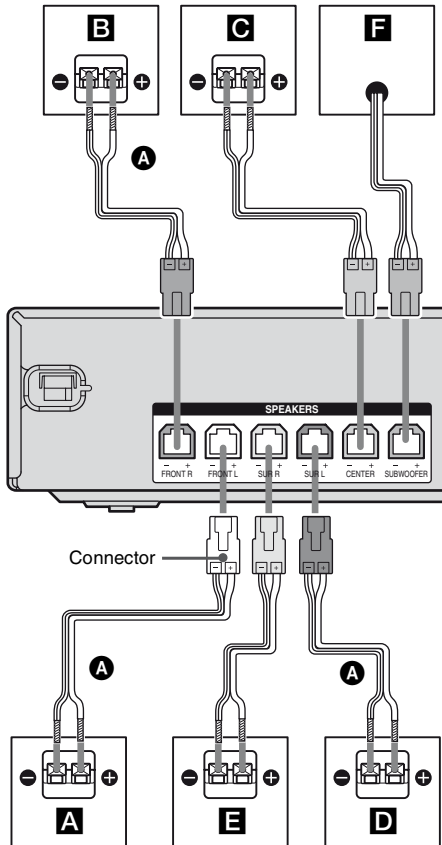

A Speaker cord (supplied)

A Front speaker (left)

B Front speaker (right)

C Center speaker

D Surround speaker (left)

E Surround speaker (right)

F Subwoofer

Note on speaker cords

The connector of the speaker cords are the same color as the speaker jack to be connected. When connecting a speaker cord, be sure to match the colored connector to the speaker jack on the receiver:

Connector	Speaker jack
Red	FRONT R
White	FRONT L
Grey	SUR R
Blue	SUR L
Green	CENTER
Purple	SUBWOOFER

To connect the speakers correctly

Check the speaker type by referring to the speaker label* at the rear panel of the speakers.

Character on speaker label	Speaker type
L	Front left
R	Front right
SL	Surround left
SR	Surround right

* The center speaker and subwoofer do not have the character on the speaker label. For details on the speaker type, see page 3.

3: Connecting the TV

You can watch the selected input image when you connect the HDMI OUT jack to a TV. It is not necessary to connect all the cords. Connect audio and video cords according to the jacks of your components. Before connecting the cords, be sure to disconnect the AC power cord.

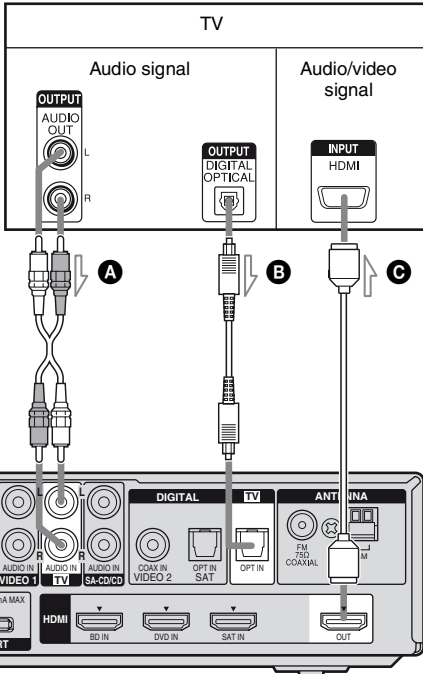

- A** Audio cord (not supplied)
- B** Optical digital cord (not supplied)
- C** HDMI cable (not supplied)

We recommend that you use a Sony HDMI cable.

Notes

- Be sure to turn on the receiver when the video and audio signals of a playback component are being output to a TV via the receiver. Unless the power is turned on, neither video nor audio signals will be transmitted.
- When connecting optical digital cords, insert the plugs straight in until they click into place.
- Do not bend or tie optical digital cords.

Tips

- To output the sound of the TV from the speakers connected to the receiver, be sure to
 - connect the audio output jacks of the TV to the TV IN jacks of the receiver.
 - turn off the TV's volume or activate the TV's muting function.
- All the digital audio jacks are compatible with 32 kHz, 44.1 kHz, 48 kHz, and 96 kHz sampling frequencies.

4: Connecting the audio/video components

How to hook up your components

This section describes how to hook up your components to this receiver. Before you begin, see “Component to be connected” below for the pages which describe how to connect the audio/video components.

Before connecting the cords, be sure to disconnect the AC power cord.

After hooking up all your components, proceed to “5: Connecting the antennas” (page 21).

Component to be connected

To connect	See
TV	page 16
Audio components	page 17
<ul style="list-style-type: none"> • Super Audio CD player/ CD player • DIGITAL MEDIA PORT adapter 	
Components with HDMI jack	page 18
Video components	page 20
<ul style="list-style-type: none"> • DVD recorder, DVD player • Satellite tuner, Set-top box • VCR 	

Connecting audio components

The following illustration shows how to connect audio components such as Super Audio CD player or CD player and DIGITAL MEDIA PORT adapter.

You can also view the images on the TV screen by connecting the video output of the DIGITAL MEDIA PORT adapter to the video input of the TV. However, depending on the DIGITAL MEDIA PORT adapter, video output may not be possible.

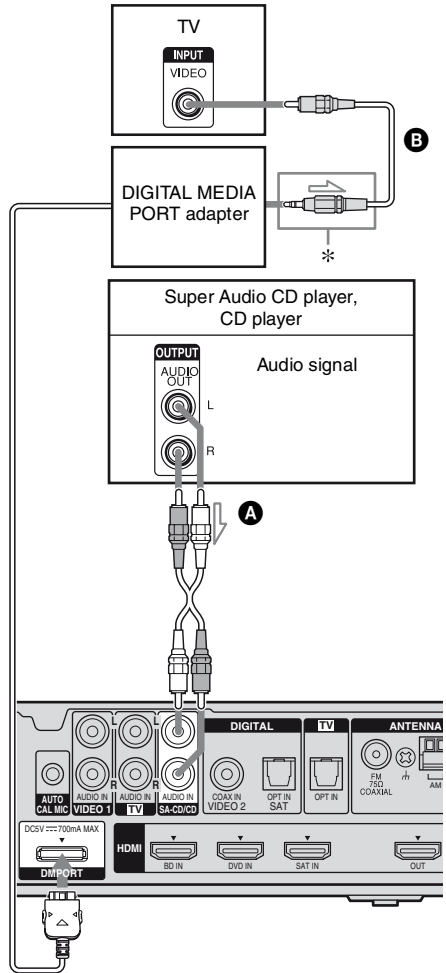

- A** Audio cord (not supplied)
- B** Video cord (not supplied)

* The type of connector varies depending on the DIGITAL MEDIA PORT adapter.

For details, refer to the operating instructions supplied with the DIGITAL MEDIA PORT adapter.

Notes on connecting DIGITAL MEDIA PORT adapter

- Do not connect or disconnect the DIGITAL MEDIA PORT adapter while the receiver is turned on.
- Be sure to make DMPORT connections firmly, insert the connector straight in.
- As the connector of the DIGITAL MEDIA PORT adapter is fragile, be sure to handle with care when placing or moving the receiver.
- When connecting the DIGITAL MEDIA PORT adapter, be sure the connector is inserted with the arrow mark facing towards the arrow mark on the DMPORT jack. To detach the DIGITAL MEDIA PORT adapter, press and hold **A** and then pull out the connector.

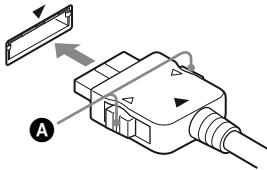

Connecting components with HDMI jacks

HDMI is the abbreviated name for High-Definition Multimedia Interface. It is an interface which transmits video and audio signals in digital format.

Sony recommends that you connect components to the receiver using an HDMI cable.

With HDMI, you can easily enjoy both high quality sound and high quality images.

However, it is necessary to connect the audio output of the TV to the audio input of the receiver using an optical cord to listen to the TV multi channel surround sound broadcasting from the receiver.

By connecting Sony “BRAVIA” Sync compatible components using HDMI cables, ““BRAVIA” Sync Features” makes operations simpler (page 44).

HDMI features

- A digital audio signals transmitted by HDMI can be output from the speakers connected to the receiver. This signal supports Dolby Digital, DTS and Linear PCM.
- This receiver supports xvYCC transmission.
- This receiver supports the Control for HDMI function. For details, see ““BRAVIA” Sync Features” (page 44).

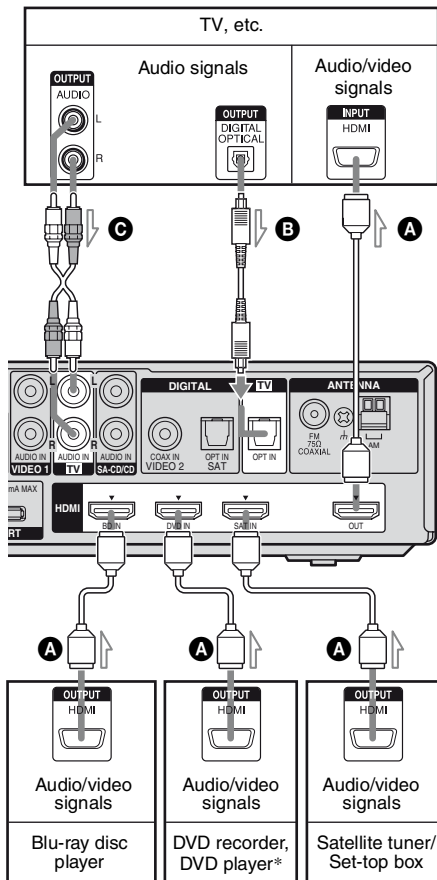

A HDMI cable (not supplied)

We recommend that you use a Sony HDMI cable.

B Optical digital cord (not supplied)^{a)}

C Audio cord (not supplied)^{a)}

^{a)} Connect at least one of the audio cords (**B** or **C**).

* If you connect a DVD player, be sure to change the factory setting of the DVD button on the remote so that you can use the button to control your DVD player. For details, see "Changing the input button assignments" (page 51).

Notes on HDMI connections

- An audio signal input to the HDMI IN jack is output from the SPEAKERS jacks and HDMI OUT jack. It is not output from any other audio jacks.
- Video signals input to the HDMI IN jack can only be output from the HDMI OUT jack.
- The multi/stereo area audio signals of a Super Audio CD are not output.
- Audio signals (sampling frequency, bit length, etc.) transmitted from an HDMI jack may be suppressed by the connected component. Check the setup of the connected component if the image is poor or the sound does not come out of a component connected via the HDMI cable.
- Sound may be interrupted when the sampling frequency, the number of channels or the audio format of the audio output signals from the playback component is switched.
- When the connected component is not compatible with copyright protection technology (HDCP), the image and/or the sound from the HDMI OUT jack may be distorted or may not be output. In this case, check the specification of the connected component.
- You can enjoy multi channel Linear PCM only with an HDMI connection.
- Set the image resolution of the playback component to 720p, 1080i or 1080p when you output 96 kHz multi channel sound over an HDMI connection.
- You may need to make certain settings on the image resolution of the player before you can enjoy multi channel Linear PCM. Refer to the operating instructions of the player.
- Refer to the operating instructions of each component connected for details.
- We do not recommend using an HDMI-DVI conversion cable. When you connect an HDMI-DVI conversion cable to a DVI-D component, the sound and/or the image may not be output.

Connecting video components

The following illustration shows how to connect video components such as DVD player, DVD recorder, VCR, etc. It is not necessary to connect all the cords. Connect audio and video cords according to the jacks of your components.

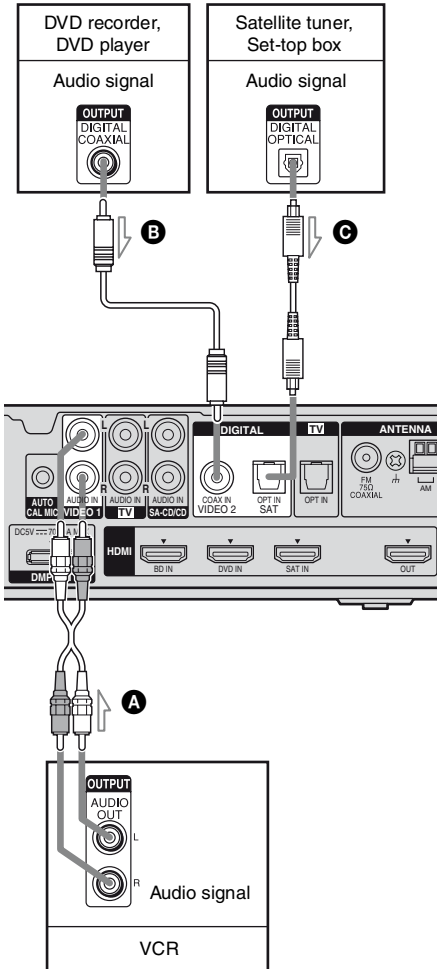

- A** Audio cord (not supplied)
- B** Coaxial digital cord (not supplied)
- C** Optical digital cord (not supplied)

Notes

- To input multi channel digital audio from the DVD player, set the digital audio output setting on the DVD player. Refer to the operating instructions supplied with the DVD player.
- When connecting optical digital cords, insert the plugs straight in until they click into place.
- Do not bend or tie optical digital cords.
- Be sure to connect the video output of the DVD player, DVD recorder and VCR to the TV, so that the image is displayed on the TV. Refer to the operating instructions of each connected component for details.
- You cannot do recording on the DVD recorder or VCR via this receiver. For details, refer to the operating instructions supplied with the DVD recorder or VCR.

Tip

All the digital audio jacks are compatible with 32 kHz, 44.1 kHz, 48 kHz, and 96 kHz sampling frequencies.

5: Connecting the antennas

Connect the supplied AM loop antenna and FM wire antenna.

Before connecting the antennas, be sure to disconnect the AC power cord.

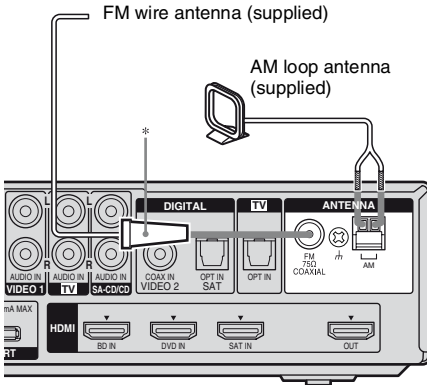

* The shape of the connector varies depending on the area code of this receiver.

Notes

- To prevent noise pickup, keep the AM loop antenna away from the receiver and other components.
- Be sure to fully extend the FM wire antenna.
- After connecting the FM wire antenna, keep it as horizontal as possible.

6: Preparing the receiver and the remote

Connecting the AC power cord

Connect the AC power cord to a wall outlet.

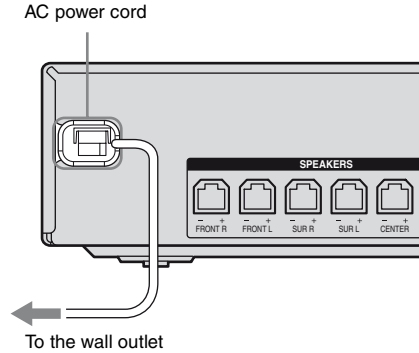

Performing initial setup operations

Before using the receiver for the first time, initialize the receiver by performing the following procedure. This procedure can also be used to return settings you have made to their factory defaults.

Be sure to use the buttons on the receiver for this operation.

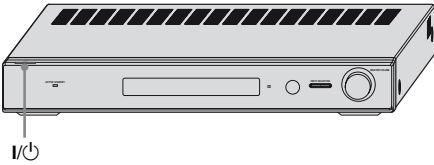

- 1 Press I/⏻ to turn on the receiver.**
- 2 Hold down I/⏻ for 5 seconds.**
“CLEARED” appears.
All the settings you have changed or adjusted are reset to the initial settings.

Inserting batteries into the remote

Insert two R6 (size-AA) batteries in the RM-AAU058 Remote Commander. Observe the correct polarity when installing batteries.

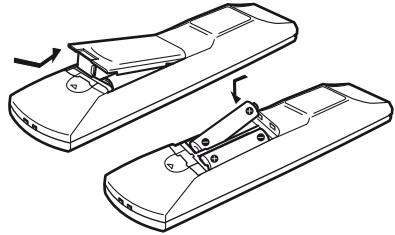

Notes

- Do not leave the remote in an extremely hot or humid place.
- Do not use a new battery with old ones.
- Do not mix manganese batteries and other kinds of batteries.
- Do not expose the remote sensor to direct sunlight or lighting apparatuses. Doing so may cause a malfunction.
- If you do not intend to use the remote for an extended period of time, remove the batteries to avoid possible damage from battery leakage and corrosion.
- When you replace the batteries, the remote buttons may be reset to their factory settings. If this happens, reassign the buttons again (page 51).
- When the remote no longer operates the receiver, replace all the batteries with new ones.

7: Calibrating the appropriate settings automatically

(AUTO CALIBRATION)

This receiver is equipped with DCAC (Digital Cinema Auto Calibration) Technology which allows you to perform automatic calibration as follows:

- Check the connection between each speaker and the receiver.
- Adjust the speaker level.
- Measure the distance of each speaker from your listening position.
- Measure the frequency characteristics.*

* The measurement result is not utilized for signals with a sampling frequency of more than 96 kHz.

The DCAC is designed to obtain proper sound balance in your room. However, you can adjust the speaker levels manually according to your preference. For details, see “8: Adjusting the speaker levels (TEST TONE)” (page 27).

Before you perform Auto Calibration

Before you perform the Auto Calibration, set up and connect the speakers (page 12, 15).

- The AUTO CAL MIC jack is used for the supplied optimizer microphone only. Do not connect other microphones to this jack. Doing so may damage the receiver and the microphone.
- During the calibration, the sound that comes out of the speakers is very loud. The volume of the sound cannot be adjusted. Pay attention to the presence of children or to the effect on your neighborhood.
- Perform the Auto Calibration in a quiet environment to avoid the effect of noise and to get a more accurate measurement.
- If there are any obstacles in the path between the optimizer microphone and the speakers, the calibration cannot be performed correctly. Remove any obstacles from the measurement area to avoid measurement error.

Note

If the muting function has been activated before you perform Auto Calibration, the muting function will be set to off automatically.

Example: HT-SS100

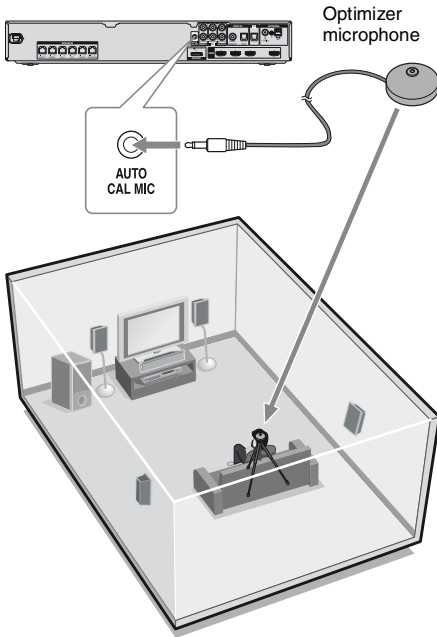

1 Connect the supplied optimizer microphone to the AUTO CAL MIC jack.

2 Set up the optimizer microphone.

Place the optimizer microphone at your listening position. You can also use a stool or tripod so that the optimizer microphone remains at the same height as your ears.

Tip

When you face the speaker towards the optimizer microphone, you will get a more accurate measurement.

Performing Auto Calibration

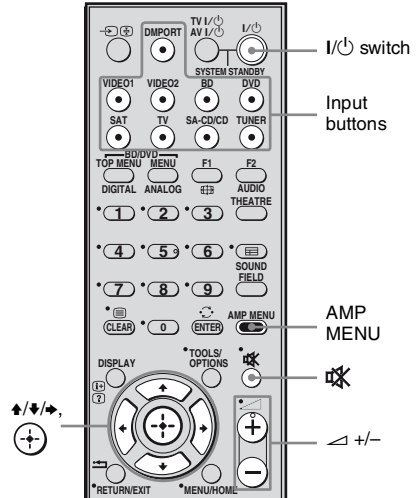

1 Press AMP MENU.

2 Press \uparrow/\downarrow repeatedly to select "A.CAL".

3 Press \oplus or \rightarrow to enter the menu.

"START" appears on the display.

4 Press \oplus to start measurement.

Measurement starts in 5 seconds.

While the time is counting down, stand away from the measurement area to avoid measurement error.

The measurement process will take approximately 30 seconds to complete. The table below shows the display when measurement starts.

Measurement for	Display
Speaker existence	TONE
Speaker gain, distance, frequency response	T.S.P.
Subwoofer gain and distance	WOOFER

Note

If “CHK MIC” appears, you cannot perform the Auto Calibration. Connect the optimizer microphone, then perform the Auto Calibration again.

Tips

- When Auto Calibration starts:
 - Stand some distance from the speakers and the listening position to avoid measurement failure. This is because test signals are output from the speakers during measurement.
 - Avoid making noise to get a more accurate measurement.
- The Auto Calibration function will be canceled when you do the following during the measurement process:
 - Press I/⏻ or 🔊.
 - Press input buttons on the remote or INPUT SELECTOR on the receiver.
 - Change the volume level.

Confirming/saving the measurement results

1 Confirm the measurement result.

When the measurement ends, a beep sounds and the measurement result appears on the display.

Measurement result	Display	Explanation
When the measurement process completes properly	SAVE	Proceed to step 2.
When the measurement process fails	ERROR XXXX	See “When error codes appear” (page 25).

2 Press \uparrow/\downarrow repeatedly to select the item. Then, press \oplus .

Item	Explanation
SAVE	Saves the measurement results and exits the setting process.
WRN CHK	Displays warning concerning the measurement results. See “When you select “WRN CHK”” (page 26).
DIST	Displays the measurement result for speaker distance.
LEVEL	Displays the measurement result for speaker level.
EXIT	Exits the setting process without saving the measurement results.

Note

After “SAVE” is displayed for 50 seconds, the measurement result is saved automatically, without the need to save the procedure.

3 Save the measurement result.

Select “SAVE” in step 2.

The measurement results are saved.

When error codes appear

Try the remedies and perform the Auto Calibration again.

Error code	Cause and remedies
ERROR 32	<ul style="list-style-type: none"> • The sound input from the optimizer microphone is out of the acceptable range. • The optimizer microphone or subwoofer may be damaged. Contact your Sony dealer or local authorized Sony service facility.
ERROR F 33	<p>The front speakers are not connected.</p> <p>Check that the front speakers are connected properly.</p>

Error code	Cause and remedies
ERROR SR33	Either the surround left or surround right speaker is not connected. Check that the surround speakers are connected properly.
ERROR SW33	The subwoofer may be damaged. Contact your Sony dealer or local authorized Sony service facility.

When you select “WRN CHK”

If a warning on the measurement result is present, detailed information is displayed.

Press **⊕** or **←** to return to step 2 of “Confirming/saving the measurement results”.

Warning code	Explanation
WARN 40	The Auto Calibration has completed. However, the noise level is high. You may be able to perform the Auto Calibration properly if you try it again, even though the measurement cannot be performed in all environments. Try to perform the Auto Calibration in a quiet environment.
WARN 41 WARN 42	The sound input from the optimizer microphone is out of the acceptable range. The distance between the optimizer microphone and the speakers is too closed. Set them away, and then try to perform the Auto Calibration.
WARN 43	The distance and position of the subwoofer cannot be detected. This may be caused by noise. Try to perform the Auto Calibration in a quiet environment.
NO WARN	There is no warning information.

When you select “DIST” or “LEVEL”

You can check the speaker distance or speaker level.

Note

The measurement result of a speaker will not appear if the receiver does not recognize that the speaker is connected.

When you have finished

Disconnect the optimizer microphone from the receiver.

Note

If you have changed the position of the speakers, it is recommended that you perform Auto Calibration again in order to enjoy the surround sound.

Clearing the measurement result

You can delete the result of Auto Calibration. If there is no saved data, you cannot perform this operation.

- 1 Press AMP MENU.**
- 2 Press **↑/↓** repeatedly until “A.CAL” appears, then press **⊕** or **→**.**
- 3 Press **↑/↓** repeatedly to select “A.CAL CLR”, then press **⊕** or **→**.**
- 4 Press **↑/↓** repeatedly to select “YES”, then press **⊕**.**

The saved result is deleted.

The settings for speaker distance and speaker level return to their defaults.

8: Adjusting the speaker levels (TEST TONE)

You can adjust the speaker levels while listening to the test tone from your listening position.

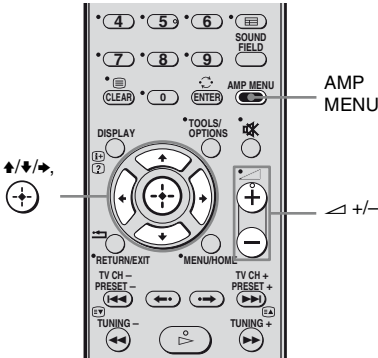

- 1** Press **AMP MENU**.
“SET HDMI” appears on the display.
- 2** Press **↑/↓** repeatedly until “LEVEL” appears, then press **⊕** or **➡**.
- 3** Press **↑/↓** repeatedly until “T. TONE” appears, then press **⊕** or **➡**.
- 4** Press **↑/↓** repeatedly to select “T. TONE Y”, then press **⊕**.
The test tone is output from each speaker in sequence as follows:
Front left → Center → Front right → Surround right → Surround left → Subwoofer
- 5** Press **←** until “T. TONE” appears.

- 6** Press **↑/↓** repeatedly to select the desired speaker, then press **⊕** or **➡**.

The test tone is emitted from the speaker that is being adjusted only.

- FL LVL: adjusts the front left speaker level.
- CNT LVL: adjusts the center speaker level.
- FR LVL: adjusts the front right speaker level.
- SR LVL: adjusts the surround right speaker level.
- SL LVL: adjusts the surround left speaker level.
- SW LVL: adjusts the subwoofer level.

Notes

- “CNT LVL” does not appear when you set “CNT N” in the “SP SETUP” setting.
- “SR LVL” and “SL LVL” do not appear when you set “SUR N” in the “SP SETUP” setting.

- 7** Press **↑/↓** repeatedly to adjust the speaker level, then press **⊕** or **➡**.

You can adjust from -6.0 dB to $+6.0$ dB in 0.5 dB steps.

Note

If you do not adjust for a certain period, the test tone is emitted from the next speaker in sequence.

- 8** Repeat step 6 and 7 to adjust the other speaker level.
- 9** After you have finished making adjustments, press **↑/↓** repeatedly until “T. TONE” appears, then press **⊕** or **➡**.
- 10** Press **↑/↓** repeatedly to select “T. TONE N,” then press **⊕**.

- 11** Press **AMP MENU**.

The AMP menu turns off.

When a test tone is not output from the speakers

- The speaker cords may not be connected securely.
- The speaker cords may have the short-circuit problem.

Note

The test tone signals are not output from the HDMI OUT jack.

Playback

Selecting a component

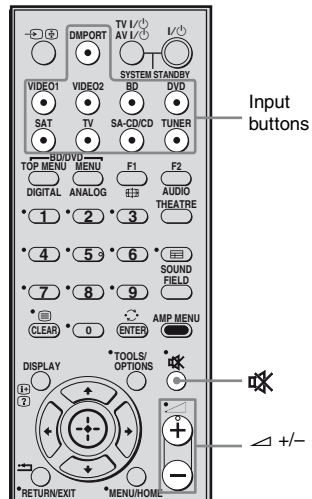

1 Press the input button to select a component.

You can also use INPUT SELECTOR on the receiver.

The selected input appears on the display.

Selected input [Display]	Components that can be played back
DMPORT [DMPORT]	DIGITAL MEDIA PORT adapter connected to the DMPORT jack
VIDEO1 or VIDEO2 [VIDEO 1 or VIDEO 2]	VCR, etc., connected to the VIDEO 1 or VIDEO 2 jack
BD [BD]	Blu-ray disc player, etc., connected to the BD jack
DVD [DVD]	DVD player, DVD recorder, etc., connected to the DVD jack
SAT [SAT]	Satellite tuner, set-top box, etc., connected to the SAT jack

Selected input [Display]	Components that can be played back
TV [TV]	TV, etc., connected to the TV jack
SA-CD/CD [SA-CD/CD]	Super Audio CD/CD player, etc., connected to the SA-CD/CD jack
TUNER [FM or AM band]	Built-in radio tuner

2 Turn on the component and start playback.

3 Press \triangle +/- to adjust the volume.

You can also use MASTER VOLUME on the receiver.

To activate the muting function

Press MUTE .

The muting function will be canceled when you do the following.

- Press MUTE again.
- Increase the volume.
- Turn off the receiver.

To avoid damaging your speakers

Before you turn off the receiver, be sure to turn down the volume level.

Enjoying sound/images from the components connected to the receiver

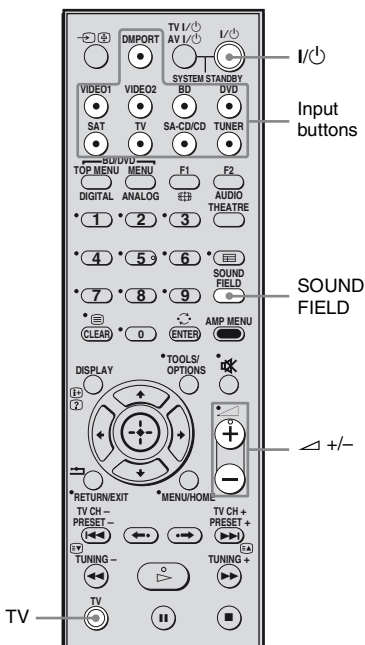

Enjoying TV

1 Turn on the TV and choose a program.

For details, refer to the operating instructions of the TV.

2 Turn on the receiver.

3 Press TV.

4 Adjust the volume of the receiver.

Tips

- When you connect a Sony TV, the audio input of the TV is switched and the image from the TV tuner is displayed on the TV screen automatically by pressing the TV button. To change this setting, see “Changing the input button assignments” (page 51).
- The sound may be output from the TV’s speaker. In this case, turn the volume of the TV’s speaker down to the minimum.

Enjoying a satellite tuner or Set-top box

1 Turn on the TV.

For details, refer to the operating instructions of the TV.

2 Turn on the satellite tuner or Set-top box and the receiver.

3 Press SAT.

You can also use INPUT SELECTOR on the receiver to select “SAT”.

4 Change the TV input.

For details, refer to the operating instructions of the TV.

5 Adjust the volume of the receiver.

Tip

The sound may be output from the TV’s speaker. In this case, turn the volume of the TV’s speaker down to the minimum.

Enjoying Blu-ray disc/DVD

1 Turn on the TV.

2 Turn on the Blu-ray disc/DVD player (recorder) and the receiver.

3 Press DVD or BD.

You can also use INPUT SELECTOR on the receiver to select “DVD” or “BD”. Be sure to change the factory setting of the DVD input button on the remote so that you can use the button to control your DVD player. For details, see “Changing the input button assignments” (page 51).

4 Change the TV input.

For details, refer to the operating instructions of the TV.

5 Play back the disc.

6 Adjust the volume of the receiver.

Tip

Even if you playback Dolby True HD, Dolby Digital Plus or DTS-HD with a connected component compatible with these sound formats, the receiver accepts as Dolby Digital or DTS. When you connect the component to the receiver using an HDMI cable to playback these high-quality sound formats, set the connected component to output the sound in multi channel PCM, if possible.

Enjoying a VCR

- 1 Turn on the TV.**
- 2 Turn on the VCR player and the receiver.**
- 3 Press VIDEO1 or VIDEO2.**

You can also use INPUT SELECTOR on the receiver to select “VIDEO 1” or “VIDEO 2”.
- 4 Change the TV input.**

For details, refer to the operating instructions of the TV.
- 5 Play back the tape on the VCR.**

Enjoying a Super Audio CD/CD

- 1 Turn on the Super Audio CD player/CD player, then place the disc on the tray.**
- 2 Turn on the receiver.**
- 3 Press SA-CD/CD.**

You can also use INPUT SELECTOR on the receiver to select “SA-CD/CD”.
- 4 Adjust the volume of the receiver.**

Enjoying a connected component through DMPORT connection

- 1 Press DMPORT.**

You can also use INPUT SELECTOR on the receiver to select “DMPORT”.
- 2 Start playback of the connected component.**

Tip

When listening to MP3 or other compressed music files using a portable audio source, you can enhance the sound. Press SOUND FIELD repeatedly until “P. AUDIO” appears in the display.

Amplifier Operations

Navigating through menus

By using the amplifier menus, you can make various adjustments to customize the receiver.

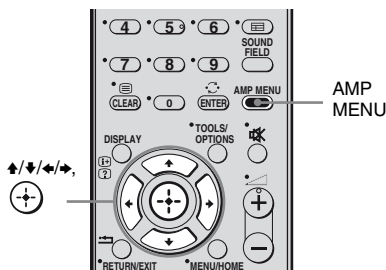

- 1 Press AMP MENU.**
“SET HDMI” appears on the display.
- 2 Press \uparrow/\downarrow repeatedly to select the menu you want.**
- 3 Press \ominus or \rightarrow to enter the menu.**
- 4 Press \uparrow/\downarrow repeatedly to select the parameter you want to adjust.**
- 5 Press \ominus or \rightarrow to enter the parameter.**
- 6 Press \uparrow/\downarrow repeatedly to select the setting you want.**
- 7 Press \ominus to enter the setting.**

To return to the previous display

Press \leftarrow .

To exit the menu

Press AMP MENU.

Overview of the menus

The following options are available in each menu. For details on navigating through menus, see page 32.

Menu [Display]	Parameters [Display]	Settings	Initial setting
HDMI setting [SET HDMI] (page 35)	Control for HDMI ^{a)b)} [CONTROL FOR HDMI]	CTRL ON, CTRL OFF	CTRL ON
	Volume Limit ^{a)} [VOL LIM]	LIM MAX, LIM 39...LIM 1, LIM MIN	LIM MAX
	Power Save ^{a)} [P.SAVE]	SAVE ON, SAVE OFF	SAVE ON
Auto Calibration setting [A.CAL] (page 35)	Auto Calibration start ^{a)} [START]	For details, see “Performing Auto Calibration” (page 24).	
	Clear Auto Calibration result ^{a)c)} [A.CAL CLR]	YES, NO	NO
Speaker setting [SP SETUP] (page 36)	Center speaker ^{a)} [CNT SP]	CNT Y, CNT N	CNT Y
	Surround speakers ^{a)} [SUR SP]	SUR Y, SUR N	SUR Y
	Front left speaker distance ^{a)d)} [FL DIST]	FL 0.00 m to FL 7.00 m (0.10 m step)	FL 3.00 m
	Center speaker distance ^{a)d)} [CNT DIST]	CNT 0.00 m to CNT 7.00 m (0.10 m step)	CNT 3.00 m
	Front right speaker distance ^{a)d)} [FR DIST]	FR 0.00 m to FR 7.00 m (0.10 m step)	FR 3.00 m
	Surround right speaker distance ^{a)d)} [SR DIST]	SR 0.00 m to SR 7.00 m (0.10 m step)	SR 3.00 m
	Surround left speaker distance ^{a)d)} [SL DIST]	SL 0.00 m to SL 7.00 m (0.10 m step)	SL 3.00 m
	Subwoofer distance ^{a)d)} [SW DIST]	SW 0.00 m to SW 7.00 m (0.10 m step)	SW 3.00 m

Menu [Display]	Parameters [Display]	Settings	Initial setting
Level setting [LEVEL] (page 37)	Test tone ^{a)} [T. TONE]	T. TONE Y, T. TONE N	T. TONE N
	Front left speaker level [FL LVL]	FL -6.0 dB to FL +6.0 dB (0.5 dB step)	FL 0.0 dB
	Center speaker level [CNT LVL]	CNT -6.0 dB to CNT +6.0 dB (0.5 dB step)	CNT 0.0 dB
	Front right speaker level [FR LVL]	FR -6.0 dB to FR +6.0 dB (0.5 dB step)	FR 0.0 dB
	Surround right speaker level [SR LVL]	SR -6.0 dB to SR +6.0 dB (0.5 dB step)	SR 0.0 dB
	Surround left speaker level [SL LVL]	SL -6.0 dB to SL +6.0 dB (0.5 dB step)	SL 0.0 dB
	Subwoofer level [SW LVL]	SW -6.0 dB to SW +6.0 dB (0.5 dB step)	SW 0.0 dB
Tone setting [TONE] (page 37)	Bass level [BASS]	BASS -6.0 dB to BASS +6.0 dB (0.5 dB step)	BASS 0.0 dB
	Treble level [TREBLE]	TRE -6.0 dB to TRE +6.0 dB (0.5 dB step)	TRE 0.0 dB
Custom setting [CUSTOM] (page 38)	Digital broadcast language selection ^{a)} [DUAL]	MAIN, SUB, MAIN/SUB	MAIN
	Synchronizes audio with video output ^{d)} [A/V SYNC]	SYNC 20 to SYNC 1, SYNC OFF	SYNC OFF
	Audio dynamic range compression ^{a)} [AUD. DRC]	DRC OFF, DRC STD, DRC MAX	DRC OFF
	Brightness of the display ^{a)} [DIMMER]	DIMMER Y, DIMMER N	DIMMER N
	Display ^{a)} [DISPLAY]	DSPL ON, DSPL OFF	DSPL ON
	Sleep timer ^{a)} [SLEEP]	SLP OFF, SLP 10M...SLP 90M	SLP OFF
	Switching the audio input mode ^{a)e)} [IN MODE]	AUTO, OPT	AUTO

^{a)} For details, refer to the page in the parentheses.

^{b)} "CONTROL FOR HDMI" scroll across the display, then "CONTROL" appears.

^{c)} This parameter is only available when the result of the Auto Calibration is saved.

^{d)} When the Auto Calibration result is saved, you can adjust the setting in 0.01 meter increment.

^{e)} This parameter is only available when SAT input is selected.

Settings for the HDMI (SET HDMI menu)

You can use the SET HDMI menu to make various adjustments for HDMI settings. Select “SET HDMI” in the amplifier menus. For details on adjusting the parameters, see “Navigating through menus” (page 32) and “Overview of the menus” (page 33).

SET HDMI menu parameters

■ CONTROL FOR HDMI (Control for HDMI)

Lets you turn the Control for HDMI function on or off. For details, see “Preparing for the “BRAVIA” Sync” (page 45).

■ VOL LIM (Volume Limit)

Lets you set the volume limit of your receiver. For details, see “Using the Volume Limit function” (page 47).

■ P.SAVE (Power Save)

Lets you save the power consumption during power standby mode while Control for HDMI function is set to on.

For details, see “Using the Power Saving function (Power Save)” (page 48).

Settings for the Auto Calibration (A.CAL menu)

You can use the A.CAL menu to make settings for the Auto Calibration function to suit your preference.

Select “A.CAL” in the amplifier menus. For details on adjusting the parameters, see “Navigating through menus” (page 32) and “Overview of the menus” (page 33).

A.CAL menu parameters

■ START (Auto Calibration start)

Lets you start the Auto Calibration function. For details, see “Performing Auto Calibration” (page 24).

■ A.CAL CLR (Clear Auto Calibration result)

Lets you delete the Auto Calibration result. For details, see “Clearing the measurement result” (page 26).

Settings for the speaker

(SP SETUP menu)

You can use the SP SETUP menu to set the distance of the speakers connected to this receiver.

Select “SP SETUP” in the amplifier menus. For details on adjusting the parameters, see “Navigating through menus” (page 32) and “Overview of the menus” (page 33).

SP SETUP menu parameters

■ CNT SP (Center speaker)

Lets you select the center speaker.

■ SUR SP (Surround speakers)

Lets you select the surround speakers.

■ FL DIST (Front left speaker distance)

■ FR DIST (Front right speaker distance)

Lets you set the distance from your listening position to the front speaker (A). If both front speakers are not placed an equal distance from your listening position, set the distance to the closest speaker.

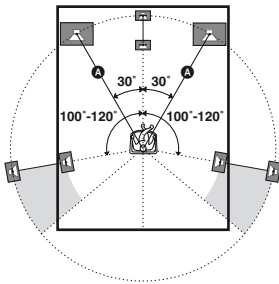

■ CNT DIST (Center speaker distance)

Lets you set the distance from your listening position to the center speaker.

■ SR DIST (Surround right speaker distance)

■ SL DIST (Surround left speaker distance)

Lets you set the distance from your listening position to the surround speakers.

■ SW DIST (Subwoofer distance)

Lets you set the distance from your listening position to the subwoofer.

Notes

- “CNT DIST” does not appear when you set “CNT N” in the “SP SETUP” setting.
- “SR DIST” and “SL DIST” do not appear when you set “SUR N” in the “SP SETUP” setting.

Tip

When the Auto Calibration result is saved, you can adjust the speakers distance in 1 cm steps. If the Auto Calibration result is not saved, you can adjust the speakers distance in 10 cm steps.

Adjusting the level

(LEVEL menu)

You can use the LEVEL menu to adjust the level of each speaker.

Select “LEVEL” in the amplifier menus. For details on adjusting the parameters, see “Navigating through menus” (page 32) and “Overview of the menus” (page 33).

LEVEL menu parameters

■ T. TONE (Test tone)

Lets you adjust the speaker levels while listening to the test tone from your listening position. For details, see “8: Adjusting the speaker levels (TEST TONE)” (page 27).

■ FL LVL (Front left speaker level)

■ CNT LVL (Center speaker level)

■ FR LVL (Front right speaker level)

■ SR LVL (Surround right speaker level)

■ SL LVL (Surround left speaker level)

■ SW LVL (Subwoofer level)

Notes

- “CNT LVL” does not appear when you set “CNT N” in the “SP SETUP” setting.
- “SR LVL” and “SL LVL” do not appear when you set “SUR N” in the “SP SETUP” setting.

Adjusting the tone

(TONE menu)

You can use the TONE menu to adjust the tonal quality (bass/treble level) of the speakers.

Select “TONE” in the amplifier menus. For details on adjusting the parameters, see “Navigating through menus” (page 32) and “Overview of the menus” (page 33).

TONE menu parameters

■ BASS (Bass level)

■ TREBLE (Treble level)

Custom settings

(CUSTOM menu)

You can use the CUSTOM menu to make various settings to suit your preference. Select “CUSTOM” in the amplifier menus. For details on adjusting the parameters, see “Navigating through menus” (page 32) and “Overview of the menus” (page 33).

CUSTOM menu parameters

■ DUAL (Digital broadcast language selection)

Lets you select the language you want to listen to during digital broadcast. This feature only functions for Dolby Digital sources.

- MAIN
Sound of the main language will be output.
- SUB
Sound of the sub language will be output.
- MAIN/SUB
Sound of the main language will be output through the front left speaker and sound of the sub language will be output through the front right speaker simultaneously.

■ A/V SYNC (Synchronizes audio with video output)

Lets you delay the audio output so that the time gap between the audio output and visual display is minimized. You can adjust from OFF, 1 (10ms) to 20 (200 ms) in 1 (10ms) steps.

Notes

- You may not be able to adjust the delay between sound and image perfectly using this function.
- This function is useful only for Dolby Digital, DTS and Linear PCM (2ch) input by optical and coaxial audio input signals.

■ AUD. DRC (Audio dynamic range compression)

Lets you compress the dynamic range of the sound track. This may be useful when you want to watch movies at low volumes late at night. Audio dynamic range compression is possible with Dolby Digital sources only.

- DRC OFF
The audio dynamic range is not compressed.
- DRC STD
The audio dynamic range is compressed as intended by the recording engineer.
- DRC MAX
The audio dynamic range is compressed dramatically.

Tip

Audio dynamic range compression lets you compress the dynamic range of the soundtrack based on the dynamic range information included in the Dolby Digital signal.

“DRC STD” is the standard setting, but it only enacts light compression. Therefore, we recommend using the “DRC MAX” setting. This greatly compresses the dynamic range and lets you view movies late at night at low volumes. Unlike analog limiters, the levels are predetermined and provide a very natural compression.

■ DIMMER (Brightness of the display)

Lets you adjust the brightness of the display. For details, see “Changing the brightness of the display (DIMMER)” (page 49).

■ DISPLAY (Display)

Lets you turn on or off the display. For details, see “Changing the display setting (DISPLAY)” (page 50).

■ SLEEP (Sleep timer)

Lets you set the timer to power off the receiver automatically. For details, see “Using the Sleep Timer (SLEEP)” (page 50).

■ IN MODE (Switching the audio input mode)

Lets you set the audio input mode of inputs. For details, see “Switching the audio input mode (IN MODE)” (page 51).

This parameter is only available when SAT input is selected.

Selecting the sound field

This receiver can create multi channel surround sound. You can select one of the optimized sound fields from the system's preprogrammed sound fields

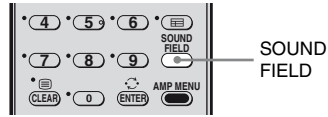

Press SOUND FIELD repeatedly to select the sound field you want.

For details, see “Types of sound field available” (page 39).

Types of sound field available

Sound field for	Sound field [Display]	Effect
A.F.D.	2CH STEREO [2CH ST]	When multi channel surround formats are input, the signals are downmixed to 2 channel.
	A.F.D. STANDARD [A.F.D. STD]	Presents the sound as it was recorded/encoded without adding any surround effects. However, this receiver will generate a low frequency signal for output to the subwoofer when there is no LFE signals.
	A.F.D. MULTI [A.F.D. MULT]	Reproduce sound from any of the format to 2 or more speakers.
	PRO LOGIC [DOLBY PL]	Performs Dolby Pro Logic decoding. The source recorded in 2 channel format is decoded into 4.1 channels.
	PRO LOGIC II MOVIE [PLII MV]	Performs Dolby Pro Logic II Movie mode decoding. This setting is ideal for movies encoded in Dolby Surround. In addition, this mode can reproduce sound in 5.1 channel for watching videos of overdubbed or old movies.
	PRO LOGIC II MUSIC [PLII MS]	Performs Dolby Pro Logic II Music mode decoding. This setting is ideal for normal stereo sources such as CDs.
Movie	MOVIE-D.C.S.- [MV-D.C.S.-]*	Reproduces the sound characteristics of the Sony Pictures Entertainment “Cary Grant Theater” cinema production studio. This is a standard mode, great for watching almost any type of movie.
Music	SPORTS [SPORTS]	Reproduces the feeling of sports broadcasting.
	NEWS [NEWS]	Reproduce a clearer announcer's voice.
	PORTABLE AUDIO ENHANCER [P. AUDIO]	Reproduces a clear enhanced sound image from your portable audio device. This mode is ideal for MP3 and other compressed music.

*D.C.S. technology is used. For details see “Glossary” (page 53).

Notes

- The effects provided by the virtual speakers may cause increased noise in the playback signal.
- When listening with sound fields that employ the virtual speakers, you will not be able to hear any sound coming directly from the surround speakers.
- Multi channel Linear PCM is not available for “P. AUDIO”.
- This function does not work when:
 - signals with a sampling frequency of more than 48 kHz is input.
 - the multi channel Linear PCM signals are received via an HDMI IN jack.
- Depending on the disc or source, the beginning of the sound may be cut off as the optimum mode is automatically selected. To avoid cutting the sound, select “A.F.D. STD”.
- When the input signal is multi channel source, Dolby Pro Logic II MOVIE/MUSIC are canceled and the multi channel source is output directly.
- When the bilingual broadcast sound is input, Dolby Pro Logic II MOVIE/MUSIC are not effective.
- Depending on the input stream, the decoding mode may not be effective.
- When you select “MV-D.C.S.-” depending on the input stream, Dolby Pro Logic may be applied automatically.

Tip

You can identify the encoding format of DVD software, etc., by looking at the logo on the package.

Tuner Operations

Listening to FM/AM radio

You can listen to FM and AM broadcasts through the built-in tuner. Before operation, make sure you have connected the FM and AM antennas to the receiver (page 21).

Tuning into a station automatically (Auto Tuning)

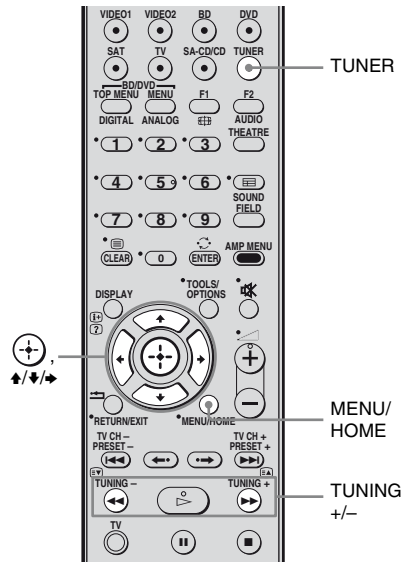

1 Press TUNER repeatedly to select the FM or AM band.

You can also use INPUT SELECTOR on the receiver.

2 Press TUNING + or TUNING –.

Press TUNING + to scan from low to high; press TUNING – to scan from high to low.

The receiver stops scanning whenever a station is received. To stop the Auto Tuning manually, press TUNING + or TUNING –.

If an FM program is noisy

If an FM program is noisy, you can select monaural reception. There will be no stereo effect, but reception will improve.

1 Press MENU/HOME.

2 Press \uparrow/\downarrow repeatedly until “FM MODE” appears, then press \oplus or \rightarrow .

3 Press \uparrow/\downarrow repeatedly to select “MONO”.

- STEREO: Stereo reception.
 - MONO: Monaural reception.
- The default setting is STEREO.

4 Press \oplus .

5 Press MENU/HOME.

Tip

To improve reception, reorient the supplied antennas.

Presetting radio stations

You can preset up to 20 FM stations and 10 AM stations. Then you can easily tune in the stations you often listen to.

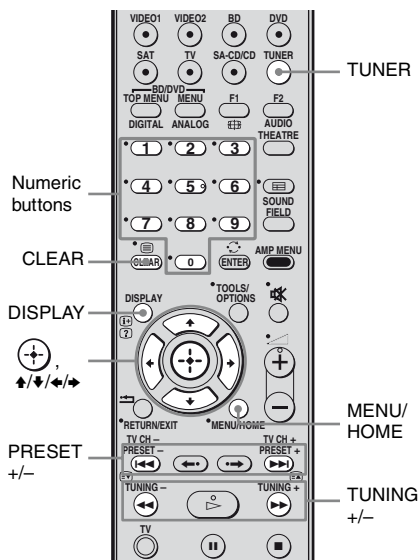

Presetting radio stations

1 Press TUNER repeatedly to select the FM or AM band.

You can also use INPUT SELECTOR on the receiver.

2 Press and hold TUNING + or TUNING – until the auto scanning starts.

Scanning stops when the receiver tunes in a station. “ST” (for stereo program) lights up in the display.

3 Press MENU/HOME.

4 Press \uparrow/\downarrow repeatedly until “MEMORY” appears in the display.

continued

5 Press **⊕** or **➔**.

A preset number appears in the display.

6 Press **▲/▼** repeatedly to select the preset number you want.

You can select the preset number directly by pressing the numeric buttons.

7 Press **⊕**.

“COMPLETE” appears in the display and the station is stored.

8 Press **MENU/HOME**.

9 Repeat 2 to 8 to store other stations.

To change the preset number

Restart from step 3.

Tuning to preset stations

1 Press **TUNER** repeatedly to select the FM or AM band.

You can also use **INPUT SELECTOR** on the receiver.

2 Press **PRESET +** or **PRESET -** repeatedly to select the preset station you want.

Each time you press the button, the receiver tunes in one preset station.

You can also press the numeric buttons to select the preset station you want. Then, press **⊕** to enter the selection.

Naming preset station

You can enter a name for preset stations. These names (for example, “XYZ”) appear in the display when a station is selected.

Note that no more than one name can be entered for each preset station.

1 Press **TUNER** repeatedly to select the FM or AM band.

You can also use **INPUT SELECTOR** on the receiver.

2 Press **PRESET +** or **PRESET -** repeatedly to select the preset station you want to create an index name for.

3 Press **MENU/HOME**.

4 Press **▲/▼** repeatedly to select “NAME IN”.

5 Press **⊕**.

6 Create a name by using **▲/▼/◀/▶**.

Press **▲/▼** repeatedly to select a character, then press **▶** to move the cursor to the next position. Letters, numbers and other symbols can be input for a radio station name.

If you enter a wrong character

Press **◀/▶** repeatedly until the character to be changed flashes, then press **▲/▼** repeatedly to select the desired character. To erase the character, press **◀/▶** repeatedly until the character to be erased flashes, then press **CLEAR**.

7 Press **⊕**.

“COMPLETE” appears in the display and the station name is stored.

8 Press **MENU/HOME**.

Viewing the station name or frequency in the display

When the receiver is set to “FM” or “AM”, you can check the frequency using the display.

Press DISPLAY.

Each time you press DISPLAY, the display changes as shown.

Station name^{a)} → Frequency^{b)}

^{a)}This is displayed if you have entered a name for a preset station.

^{b)}Returns to the original display when several seconds have elapsed.

Using the Radio Data System (RDS)

(Models of area code CEL, CEK only)

This receiver also allows you to use RDS (Radio Data System), which enables radio stations to send additional information along with the regular program signal. You can display RDS information.

Notes

- RDS is operable only for FM stations.
- Not all FM stations provide RDS service, nor do they provide the same type of services. If you are not familiar with the RDS services in your area, check with your local radio stations for details.

Receiving RDS broadcasts

Simply select a station on the FM band using automatic tuning (page 40) or preset tuning (page 42).

When you tune in a station that provides RDS services, the program service name appears on the display.

Note

RDS may not work properly if the station you tuned to is not transmitting the RDS signal properly or if the signal strength is weak.

Displaying RDS information

While receiving an RDS station, press DISPLAY repeatedly.

Each time you press the button, RDS information on the display changes cyclically as follows:

Program Service name → Frequency

“BRAVIA” Sync Features

What is “BRAVIA” Sync?

“BRAVIA” Sync is compatible with Sony TV, Blu-ray Disc/DVD player, AV amplifier, etc., that is equipped with the Control for HDMI function.

By connecting Sony components that are compatible with the “BRAVIA” Sync with an HDMI cable (not supplied), operation is simplified as follows:

- **One-Touch Play:** When you play back a component such as a DVD/Blu-ray disc player, the receiver and the TV are turned on automatically and switched to the appropriate HDMI input. Be sure that the System Audio Control setting is set to on.
- **System Audio Control:** While watching TV, you can select to output the sound from the TV speaker or the speakers connected to the receiver.
- **System Power Off:** When you turn off the TV, the receiver and connected components are also turned off simultaneously.

Control for HDMI is a mutual control function standard used by HDMI CEC (Consumer Electronics Control) for HDMI (High-Definition Multimedia Interface).

The Control for HDMI function will not operate correctly in the following cases:

- When you connect the receiver to a component which does not correspond with Sony Control for HDMI function.
- When you connect the receiver and components using other than HDMI connection.

We recommend that you connect the receiver to products featuring “BRAVIA” Sync.

Note

Depending on the connected component, the Control for HDMI function may not work. Refer to the operating instructions of the component.

Preparing for the “BRAVIA” Sync

To use the “BRAVIA” Sync, turn the Control for HDMI function on for both the receiver and the connected component.

When your TV is compatible with the “Control for HDMI-Easy Setting” function

When you connect a Sony TV with the “Control for HDMI-Easy Setting” function, the Control for HDMI function of the receiver can be turned on simultaneously by turning the Control for HDMI function of the TV on.

- 1 Make sure that the receiver, TV, and playback components are connected using an HDMI cable (not supplied). (The respective components must be compatible with the Control for HDMI function).
- 2 Turn on the receiver, TV and playback components.
- 3 Turn the Control for HDMI function of the TV on.
The Control for HDMI function of the receiver and all the connected components are simultaneously turned on. During setup, “SCANNING” appears in the display, and once setting is completed, “COMPLETE” will appear. Wait until the setup is complete.

For details on setup of the TV, refer to the operating instructions of your TV.

When your TV is not compatible with the “Control for HDMI-Easy Setting” function

Turn the Control for HDMI function of the receiver and the connected component on individually.

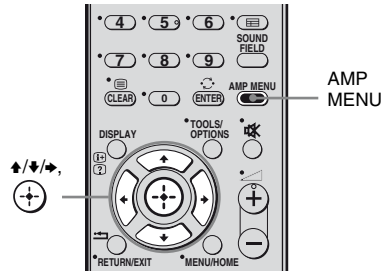

- 1 Perform the steps given in “When your TV is compatible with the “Control for HDMI-Easy Setting” function” (page 45).
- 2 Press AMP MENU.
“SET HDMI” appears on the display.
- 3 Press \odot or \rightarrow to enter the menu.
- 4 Press \updownarrow repeatedly to select “CONTROL FOR HDMI”.
“CONTROL FOR HDMI” scrolls across the display, then “CONTROL” appears.
- 5 Press \odot or \rightarrow to enter the parameter.
- 6 Press \updownarrow repeatedly to select “CTRL ON”, then press \odot .
The Control for HDMI function is set to on.
- 7 Set the Control for HDMI function of the connected component to on.
- 8 Select the HDMI input (BD, DVD, SAT) of the receiver and TV to match the HDMI output of the connected component, so that the image from the connected component is displayed.
For details on setting the TV and connected components, refer to the operating instructions of the respective components.

Notes

- When you unplug the HDMI cable or change the connection, perform the steps given in “When your TV is compatible with the “Control for HDMI-Easy Setting” function” (page 45) or “When your TV is not compatible with the “Control for HDMI-Easy Setting” function” (page 45).
- You cannot perform One-Touch Play and System Audio Control during Control for HDMI-Easy Setting operation.
- Before you do the Control for HDMI-Easy Setting from the TV, be sure to turn on the TV, connected components and receiver.
- If the playback components cannot function after you have made the settings for Control for HDMI-Easy Setting, check the Control for HDMI setting on your TV.
- If the connected components do not support Control for HDMI-Easy Setting, you need to set the Control for HDMI function for the connected components to on before you perform the Control for HDMI-Easy Setting from the TV.

Playing back components with one-touch operation (One-Touch Play)

You can enjoy sound and image from the components connected to the receiver via HDMI connections by a simple operation.

Play back a connected component.

The receiver and the TV are turned on automatically and switched to the appropriate HDMI input.

Note

Be sure that the System Audio Control setting is set to on.

Watching a DVD/Blu-ray disc by simple operation

You can also select a connected component, such as a DVD/Blu-ray disc player using the TV menu. In this case, the receiver and the TV switch to the appropriate HDMI input.

Note

Depending on the TV, the start of the content may not be output.

Tip

You can enjoy the components that are connected to the HDMI jacks, even if you turn the receiver off. The ACTIVE STANDBY indicator lights up in amber.

Enjoying the TV sound from the speakers connected to the receiver (System Audio Control)

You can enjoy the TV sound from the speakers connected to the receiver by a simple operation.

You can operate System Audio Control function using the TV menu. For details, refer to the operating instructions of the TV. When System Audio Control function is turned on, the receiver will turn on and switches to the appropriate input automatically.

TV sound is output from the speakers connected to the receiver, and the volume of the TV is minimized simultaneously.

You can use the System Audio Control function as follows.

- If you turn on the receiver while the TV is turned on, the System Audio Control function will automatically be set to on and the TV sound will output from the speakers connected to the receiver. However, if you turn off the receiver, the sound will output from the TV speakers.
- You can adjust the receiver's volume when you adjust the TV volume.

Notes

- If System Audio Control does not function according to your TV setting, refer to the operating instructions of the TV.
- When you connect a TV that does not have System Audio Control function, the System Audio Control function does not work.
- If the TV is turned on before turning on the receiver, the TV sound will not be output for a moment.

Using the Volume Limit function

When the System Audio Control function is active, and the output method changes from the TV speaker to the speakers connected to the receiver automatically, loud sound may be output depending on the volume level of the receiver. You can prevent this by limiting the maximum volume level.

- 1 Press AMP MENU.**
- 2 Press \downarrow/\uparrow repeatedly until "SET HDMI" appears, then press \oplus or \rightarrow .**
- 3 Press \downarrow/\uparrow repeatedly until "VOL LIM" appears, then press \oplus or \rightarrow .**
- 4 Press \downarrow/\uparrow repeatedly to select the maximum volume level you want.**

The maximum volume level changes as follows:

LIM MAX \leftrightarrow LIM 39 \leftrightarrow LIM 38 \leftrightarrow \leftrightarrow LIM 2 \leftrightarrow LIM 1 \leftrightarrow LIM MIN

- 5 Press AMP MENU.**

The AMP menu turns off.

Notes

- This function is available only when the Control for HDMI function is set to on.
- This function is not available when the output method changes from the speakers connected to the receiver to the TV speaker.

Tips

- Sony recommends that you set the maximum volume level to a little lower than the volume you usually listen to.
- Regardless of the maximum volume level you set, the MASTER VOLUME on the receiver and the \triangleleft +/- button of the remote are operable.
- If you do not want to limit the maximum volume level, select "MAX".

Turning off the receiver with the TV (System Power Off)

When you turn the TV off by using the POWER button on the TV's remote, the receiver and the connected components turn off automatically.

You can also use the receiver's remote to turn off the TV.

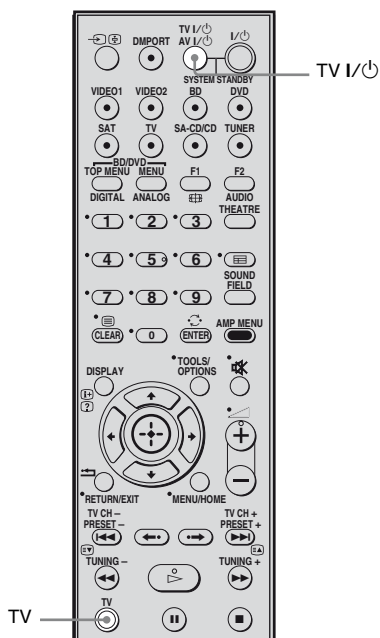

Press TV and TV I/O at the same time.

The TV, receiver and the components connected via HDMI are turned off.

Notes

- Set the TV Standby Synchro to “ON” before using the System Power Off function. For details, refer to the operating instructions of the TV.
- Depending on the status, the connected components may not be turned off. For details, refer to the operating instructions of the connected components.

Using the Power Saving function (Power Save)

You can reduce the receiver's power consumption when you connect a “BRAVIA” Sync-compatible TV to this receiver. During active standby mode, if the TV is turned off, the HDMI signal transmission will stop. Thus, power consumption will reduce.

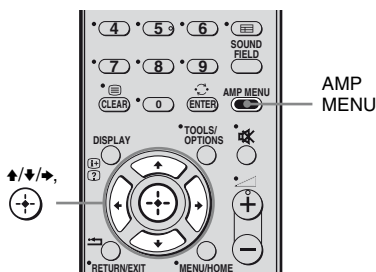

- 1 Press AMP MENU.
“SET HDMI” appears on the display.
- 2 Press \oplus or \rightarrow to enter the menu.
- 3 Press \downarrow/\uparrow repeatedly to select “P.SAVE”, then press \oplus or \rightarrow .
- 4 Press \downarrow/\uparrow repeatedly to select the setting, then press \oplus or \rightarrow .
 - SAVE ON: Reduces power consumption in standby mode. HDMI signal transmission occurs only when the TV is on.
 - SAVE OFF: No reduction. HDMI signal transmission occurs continuously.
- 5 Press AMP MENU.
The AMP menu turns off.

Notes

- The power saving function may not work for some TVs compatible with the “BRAVIA” Sync. In this case, set “P.SAVE” to “SAVE OFF.”
- Depending on your components, it may take time before image or sound is output.
- This function is available only when the Control for HDMI function is set to on.

Other Operations

Changing the brightness of the display (DIMMER)

You can change the brightness of the display.

- 1 Press AMP MENU.**
“SET HDMI” appears on the display.
- 2 Press \uparrow/\downarrow repeatedly until “CUSTOM” appears, then press \ominus or \rightarrow .**
- 3 Press \uparrow/\downarrow repeatedly until “DIMMER” appears, then press \ominus or \rightarrow .**
- 4 Press \uparrow/\downarrow repeatedly to select the brightness of the display, then press \ominus .**
 - DIMMER Y: Low lighting.
 - DIMMER N: Bright lighting.
- 5 Press AMP MENU.**
The AMP menu turns off.

Changing the display setting (DISPLAY)

You can change the display setting.

- 1 Press AMP MENU.**
“SET HDMI” appears on the display.
- 2 Press \uparrow/\downarrow repeatedly until “CUSTOM” appears, then press \odot or \rightarrow .**
- 3 Press \uparrow/\downarrow repeatedly until “DISPLAY” appears, then press \odot or \rightarrow .**
- 4 Press \uparrow/\downarrow repeatedly to change the display setting, then press \odot .**
 - DSPL ON: The display appears all the time.
 - DSPL OFF: The display appears when you operate the receiver.
- 5 Press AMP MENU.**
The AMP menu turns off.

Using the Sleep Timer (SLEEP)

You can set the receiver to turn off automatically at a specified time.

- 1 Press AMP MENU.**
“SET HDMI” appears on the display.
- 2 Press \uparrow/\downarrow repeatedly until “CUSTOM” appears, then press \odot or \rightarrow .**
- 3 Press \uparrow/\downarrow repeatedly until “SLEEP” appears, then press \odot or \rightarrow .**
- 4 Press \uparrow/\downarrow repeatedly to select the preset time, then press \odot .**
The minutes display (the remaining time) changes cyclically as follows:
SLP OFF \leftrightarrow SLP 10M \leftrightarrow SLP 20M
 \updownarrow \updownarrow
SLP 90M \leftrightarrow SLP 80M \leftrightarrow
- 5 Press AMP MENU.**
The AMP menu turns off.

Switching the audio input mode

(IN MODE)

You can select the audio input mode setting when you connect satellite tuner or set-top box to both HDMI IN jack and optical digital input jack on the receiver and SAT input has been selected.

- 1 Press AMP MENU.**
“SET HDMI” appears on the display.
- 2 Press \uparrow/\downarrow repeatedly to select “CUSTOM”.**
- 3 Press \oplus or \rightarrow to enter the menu.**
- 4 Press \uparrow/\downarrow repeatedly to select “IN MODE”.**
- 5 Press \oplus or \rightarrow to enter the parameter.**
- 6 Press \uparrow/\downarrow repeatedly to select the audio input mode you want, then press \oplus .**
- 7 Press AMP MENU.**
The AMP menu turns off.

Audio input modes

■ AUTO

Gives priority to HDMI audio signals if there are both digital (HDMI and optical) connections.

■ OPT

Specifies the digital audio signals input to the DIGITAL SAT OPT IN jack.

Using the Remote

Changing the input button assignments

You can change the factory settings of the input buttons to suit the components in your system. For example, if you connect a Blu-ray disc player to the DVD jack on the receiver, you can set the DVD button on this remote to control the Blu-ray disc player.

You cannot assign any component other than a TV to the TV (white) button of the remote.

Notes

- You can change the remote assignments for BD, DVD and SAT input buttons.
- When the receiver is in VIDEO1, VIDEO2 or SA-CD/CD mode, you cannot operate the selected component.

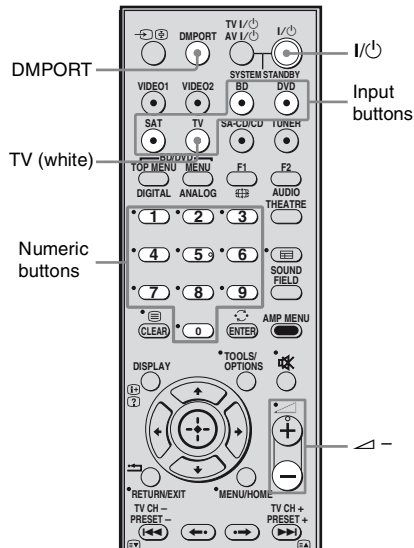

- 1 Hold down the input button of which you want to change the assignment.**

Example: Hold down DVD.

2 Referring to the following table, press the corresponding button for the category you want.

Example: Press 3.

Now you can use the DVD button to control the Blu-ray disc player.

Categories and the corresponding buttons for BD, DVD and SAT

Categories	Press
DVD player (command mode DVD1)	1
DVD recorder (command mode DVD3) ^{a)}	2
Blu-ray disc player (command mode BD1) ^{b)}	3
Blu-ray disc recorder (command mode BD3)	4
Euro Digital Satellite Receiver ^{c)}	7

^{a)}The default setting of the DVD button.
Sony DVD recorders are operated with a DVD1 or DVD3 setting. For details, refer to the operating instructions supplied with the DVD recorders.

^{b)}The default setting of the BD button.
For details on the BD1 or BD3 setting, refer to the operating instructions supplied with the Blu-ray disc player or Blu-ray disc recorder.

^{c)}The default setting of the SAT button.



Categories and the corresponding buttons for TV

Categories	Press
TV ^{d)}	5
TV ^{e)}	6

^{d)}The default setting of the TV (white) button.
When this setting is selected, the audio input of the TV is switched and the image from the TV tuner is displayed on the TV screen automatically by pressing the TV (white) button.

^{e)}When this setting is selected, the audio input of the TV is switched automatically by pressing the TV (white) button.

To clear all remote button assignments

While holding down  -, press  and DMPORT.

The remote is reset to its factory settings.

Glossary

■ Digital Cinema Sound (DCS)

A unique sound reproduction technology for home theater developed by Sony, in cooperation with Sony Pictures Entertainment, for enjoying the exciting and powerful sound of movie theaters at home. With this “Digital Cinema Sound” developed by integrating a DSP (Digital Signal Processor) and measured data, the ideal sound field intended by filmmakers can be experienced at home.

■ Dolby Digital

Digital audio encoding/decoding technology developed by Dolby Laboratories, Inc. It consists of front (left/right), center, surround (left/right) and subwoofer channels. It is a designated audio standard for DVD-video and also known as 5.1 channel surround. Since surround information is recorded and reproduced in stereo, more realistic sound with fuller presence is delivered than with Dolby surround.

■ Dolby Pro Logic II

This technology converts 2 channel stereo recorded audio into 5.1 channel for playback. There is a MOVIE mode for movies and MUSIC mode for stereo sources such as music. Old movies encoded in the traditional stereo format can be enhanced with 5.1 channel surround sound.

■ Dolby Surround (Dolby Pro Logic)

Audio processing technology developed by Dolby Laboratories, Inc. Center and mono surround information is matrixed into two stereo channels. When reproduced, audio is decoded and output in 4 channel surround sound. This is the most common audio processing method for DVD-video.

■ DTS Digital Surround

Digital audio encoding/decoding technology for theaters developed by DTS, Inc. It compresses audio less than Dolby Digital, delivering a higher quality sound reproduction.

■ HDMI (High-Definition Multimedia Interface)

HDMI (High-Definition Multimedia Interface) is an interface that supports both video and audio on a single digital connection, allowing you to enjoy high quality digital picture and sound. The HDMI specification supports HDCP (High-bandwidth Digital Contents Protection), a copy protection technology that incorporates coding technology for digital video signals.

■ L.F.E. (Low Frequency Effects)

Sound effects of low frequencies which are output from a subwoofer in Dolby Digital or DTS, etc. By adding a deep bass with a frequency between 20 to 120 Hz, audio becomes more powerful.

■ S-master

S-master is an all-digital amplifier technology developed by Sony, which effectively minimizes the occurrence of sound fragmentation and jitter, delivering superb dialog clarity and faithful reproduction of the original sound. The compact amplifier section supports a higher power efficiency and improved thermal performance.

■ Sampling frequency

To convert analog audio to digital, analog data should be quantified. This process is called sampling, and the number of times per second the analog data is quantified is called the sampling frequency. A standard music CD stores data quantified at 44,100 times per second, which is expressed as a sampling frequency of 44.1 kHz. Generally speaking, a higher sampling frequency means better sound quality.

■ TSP (Time Stretched Pulse)

A TSP signal is a highly precise measuring signal that utilizes impulse energy, measuring a wide band, from low to high, in a short period.

The amount of energy used to measure signals is important to ensure measurement accuracy in a normal indoor environment. Using TSP signals makes it possible to measure signals effectively.

■ x.v.Colour

x.v.Colour is a more familiar term for the xvYCC standard proposed by Sony, and is a trademark of Sony. xvYCC is an international standard for colour space in video.

This standard can express a wider colour range than the currently used broadcast standard.

Precautions

On safety

Should any solid object or liquid fall into the cabinet, unplug the receiver and have it checked by qualified personnel before operating it any further.

On power sources

- Before operating the receiver, check that the operating voltage is identical with your local power supply.
The operating voltage is indicated on the nameplate on the back of the receiver.
- The unit is not disconnected from the AC power source (mains) as long as it is connected to the wall outlet, even if the unit itself has been turned off.
- If you are not going to use the receiver for a long time, be sure to disconnect the receiver from the wall outlet. To disconnect the AC power cord, grasp the plug itself; never pull the cord.
- The AC power cord must be changed only at a qualified service shop.

On heat buildup

Although the receiver heats up during operation, this is not a malfunction. If you continuously use this receiver at a large volume, the cabinet temperature of the top, side and bottom rises considerably. To avoid burning yourself, do not touch the cabinet.

On placement

- Place the receiver in a location with adequate ventilation to prevent heat buildup and prolong the life of the receiver.
- Do not place the receiver near heat sources, or in a place subject to direct sunlight, excessive dust, or mechanical shock.
- Do not place anything on top of the cabinet that might block the ventilation holes and cause malfunctions.
- Do not place the receiver near equipment such as a TV, VCR, or tape deck. If the receiver is being used in combination with a TV, VCR, or tape deck, and is placed too close to that equipment, noise may result, and picture quality may suffer. This is especially likely when using an indoor antenna. Therefore, we recommend using an outdoor antenna.
- Use caution when placing the receiver or speakers on surfaces that have been specially treated (with wax, oil, polish, etc.) as staining or discoloration of the surface may result.

On operation

Before connecting other components, be sure to turn off and unplug the receiver.

If you encounter color irregularity on a nearby TV screen

The center speaker is magnetically shielded to allow it to be installed near a TV set. However, color irregularities may still be observed on certain types of TV sets. As the front speakers, surround speakers and subwoofer are not magnetically shielded, we recommend that you place the front speakers, surround speakers and subwoofer slightly further away from TV set (page 12).

If color irregularity is observed...

Turn off the TV set, then turn it on again after 15 to 30 minutes.

If color irregularity is observed again...

Place the speaker further away from the TV set.

If howling occurs

Reposition the speakers or turn down the volume on the receiver.

On cleaning

Clean the cabinet, panel, and controls with a soft cloth slightly moistened with a mild detergent solution. Do not use any type of abrasive pad, scouring powder, or solvent, such as alcohol or benzine.

If you have any questions or problems concerning your receiver, please consult your nearest Sony dealer.

Troubleshooting

If you experience any of the following difficulties while using the receiver, use this troubleshooting guide to help you remedy the problem.

Audio

There is no sound, no matter which component is selected, or only a very low-level sound is heard.

- Check that the speakers and components are connected securely.
- Check that both the receiver and all components are turned on.
- Check that MASTER VOLUME is not set to “VOL MIN”.
- Press  to cancel the muting function.
- Check that you have selected the correct component with the input buttons.
- The protective device on the receiver has been activated. Turn off the receiver, eliminate the short-circuit problem, and turn on the power again.
- Check that the IN MODE setting is correct for SAT input.

There is no sound from a specific component.

- Check that the component is connected correctly to the audio input jacks for that component.
- Check that the cord(s) used for the connection is (are) fully inserted into the jacks on both the receiver and the component.

There is no sound from one of the front speakers.

- Make sure you have connected to both the L and R jacks of an analog component, and not only to either the L or R jack. Use an audio cord (not supplied).

There is no sound from digital sources (from OPTICAL input jack).

- Check that the IN MODE is set to “AUTO” for SAT input.

There is severe hum or noise.

- Check that the speakers and components are connected securely.
- Check that the connecting cords are away from a transformer or motor, and at least 3 meters away from a TV set or fluorescent light.
- Move your audio components away from the TV.
- The plugs and jacks are dirty. Wipe them with a cloth slightly moistened with alcohol.

There is pop noise from a specific component connected to this receiver when you turn on the component.

- Check that the IN MODE is set to “AUTO” for SAT input (page 51).

There is no sound, or only a very low-level sound is heard from the center/surround speakers.

- Select MOVIE -D.C.S.- (page 39).
- Adjust the speaker level (page 27).
- Check that the speakers are connected securely.

There is no sound from the subwoofer.

- Check that the subwoofer is connected correctly and securely.

The surround effect cannot be obtained.

- Make sure the sound field function is on (press SOUND FIELD).
- Sound fields do not function for signals with a sampling frequency of more than 48 kHz.

Dolby Digital or DTS multi channel sound is not reproduced.

- Check that the DVD, etc. you are playing is recorded in Dolby Digital or DTS format.
- When connecting the DVD player, etc., to the digital input jacks of this receiver, check the audio setting (the settings for the audio output) of the connected component.

There is no sound from the component connected to the DIGITAL MEDIA PORT adapter.

- Adjust the volume of this receiver.
 - The DIGITAL MEDIA PORT adapter and/or component is not connected correctly. Turn off the receiver, then reconnect the DIGITAL MEDIA PORT adapter and/or component.
 - Check the DIGITAL MEDIA PORT adapter and/or component device to make sure it supports this receiver.
-

Video

There is no picture or an unclear picture appears on the TV screen or monitor.

- Make sure you have connected the video output of your video component to the TV.
 - Move your audio components away from the TV.
 - Depending on the DIGITAL MEDIA PORT adapter, video output may not be possible.
-

HDMI

The source sound input to the HDMI jack on the receiver is not output from the receiver or the TV speaker.

- Check the HDMI connection (page 18).
- You cannot listen to the Super Audio CD by connecting HDMI.
- Depending on the playback component, you may need to set up the component. Refer to the operating instructions supplied with each component.

The source image input to the HDMI jack on the receiver is not output from the TV.

- Check the HDMI connection (page 18).
- Depending on the playback component, you may need to set up the component. Refer to the operating instructions supplied with each component.

The Control for HDMI function does not work.

- Check the HDMI connection (page 18).
- Make sure “CONTROL FOR HDMI” is set to “CTRL ON” in SET HDMI menu.
- Make sure the connected component is compatible with the Control for HDMI function.
- Check the Control for HDMI settings on the connected component. Refer to the operating instructions of the connected component.
- Repeat the procedures of “Preparing for the “BRAVIA” Sync” if you change the HDMI connection, connect/disconnect the AC power cord, or there is a power failure (page 45).

No sound is output from the receiver and TV speaker while using the System Audio Control function.

- Make sure the TV is compatible with the System Audio Control function.
- If you cannot listen to the sound of a component connected to the receiver
 - Select the appropriate input when you want to watch a program on a component connected via HDMI connection to the receiver.
 - Change the TV channel when you want to watch a TV broadcast.
 - Select the component or input you want to watch when you watch a program on the component connected to the TV. Refer to the operating instructions of the TV on this operation.

When the receiver is in standby mode, there is no image or sound on the TV.

- When the receiver is in standby mode, image and sound are output from the HDMI component selected the last time you turned off the receiver. If you are enjoying other component, play the component and perform the One-Touch Play operation, or turn on the receiver to select the HDMI component you want to enjoy.
- Make sure “P.SAVE” is set to “SAVE OFF” in the SET HDMI menu if you connect components not compatible with the “BRAVIA” Sync to the receiver (page 48).

The volume turns down when the output method changes from the TV speaker to the speakers connected to the receiver.

- The Volume Limit function is working. For details, see “Using the Volume Limit function” (page 47).

Tuner

The FM reception is poor.

- Use a 75-ohm coaxial cable (not supplied) to connect the receiver to an outdoor FM antenna as shown below. If you connect the receiver to an outdoor antenna, ground it against lightning. To prevent a gas explosion, do not connect the ground wire to a gas pipe.

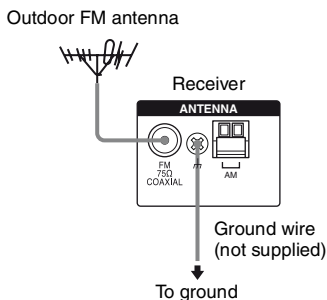

Radio stations cannot be tuned in.

- Check that the antennas are connected securely. Adjust the antennas and connect an external antenna, if necessary.
- The signal strength of the stations is too weak (when tuning in with automatic tuning). Change to monaural reception (page 40).
- No stations have been preset or the preset stations have been cleared (when tuning by scanning preset stations). Preset the stations (page 41).

RDS does not work.^{a)}

- Make sure that you are tuned to an FM RDS station.
- Select a stronger FM station.

The RDS information that you want does not appear.^{a)}

- Contact the radio station and find out whether they actually provide the service in question. If so, the service may be temporarily out of order.

^{a)} Models of area code CEL, CEK only.

Remote control

The remote does not function.

- For receiver operation, you can only use the DISPLAY button when the TUNER input is selected.
 - Point the remote at the remote sensor on the receiver.
 - Remove any obstacles in the path between the remote and the receiver.
 - Replace all the batteries in the remote with new ones, if they are weak.
 - Make sure you select the correct input on the remote.
-

Others

The ACTIVE STANDBY lamp is flashing.

- The receiver is in protection mode. Turn off the receiver and turn it on again.
-

Error messages

If an error message appears while you perform Auto Calibration, see “When error codes appear” (page 25) to solve the problem.

If you are unable to remedy the problem using the troubleshooting guide

Clearing the receiver’s memory may remedy the problem (page 22). However, note that all memorized settings will be reset to their factory settings and you will have to readjust all settings on the receiver.

If the problem persists

Consult your nearest Sony dealer. Note that if service personnel changes some parts during repair, these parts may be retained.

Reference sections for clearing the receiver’s memory

To clear	See
All memorized settings	page 22

Specifications

Amplifier section

Models of area code CEL, CEK

Power Output¹⁾

Stereo mode (rated) 108 W + 108 W
(3 ohms at 1 kHz,
THD 1%)

Surround mode (reference)

RMS Output
(3 ohms at 1 kHz,
THD 10%)
FRONT²⁾: 143 W/ch
CENTER²⁾: 143 W
SUR²⁾: 143 W/ch
(1.5 ohms at 70 Hz,
THD 10%)
SUBWOOFER²⁾: 285 W

¹⁾Measured under the following conditions:

Area code	Power requirements
CEL, CEK	230 V AC, 50 Hz

²⁾Reference power output for front, center, surround speakers and subwoofer. Depending on the sound field settings and the source, there may be no sound output.

Inputs

Analog Sensitivity: 1 V/50 kohms

Digital (Coaxial) Impedance: 75 ohms

Tone

Gain levels ±10 dB, 0.5 dB step

Reproduction frequency range:

28 – 20,000 Hz

FM tuner section

Tuning range 87.5 – 108.0 MHz

Antenna FM wire antenna

Antenna terminals 75 ohms, unbalanced

Intermediate frequency

10.7 MHz

AM tuner section

Tuning range

Models of area code CEL, CEK

With 9 kHz tuning scale:

531 kHz – 1,602 kHz

Antenna Loop antenna

Intermediate frequency
450 kHz

General

Power requirements

Area code	Power requirements
CEL, CEK	220–240 V AC, 50/60 Hz

Power output (DIGITAL MEDIA PORT)

DC OUT: 5 V, 700 mA MAX

Power consumption

Area code	Power consumption
CEL, CEK	165 W

Power consumption (during standby mode)

0.3 W (When Control for
HDMI is off)

Dimensions (w/h/d) (Approx.)

430 × 66.5 × 332 mm
including projecting parts
and controls

Mass (Approx.)

3.4 kg

Speaker section

HT-SF100 only

- **Front speaker (SS-MSP36F)**

- **Surround speaker (SS-SRP36F)**

- **Center speaker (SS-CNP36)**

Center speaker Full range, magnetically shielded

Front/Surround speaker Full range

Speaker unit

Front/Surround speaker 65 mm, cone type

Center speaker 30 × 60 mm, cone type

Enclosure type

Front/Surround speaker

Bass reflex

Center speaker Acoustic suspension

Rated impedance 3 ohms

Dimension (w/h/d) (Approx.)

Front speaker 113 × 830 × 83 mm (without stand)
315 × 1,015 – 1,345 × 315 mm (with stand)

Surround speaker 108 × 540 × 78 mm (without stand)
290 × 1,045 – 1,235 × 290 mm (with stand)

Center speaker 380 × 50 × 64 mm (with foot)

Mass (Approx.)

Front speaker 1.6 kg (without stand)
3.3 kg (with stand)

Surround speaker 1.1 kg (without stand)
2.6 kg (with stand)

Center speaker 0.38 kg

- **Subwoofer (SS-WP36)**

Speaker unit 160 mm, cone type

Enclosure type Bass reflex

Rated impedance 1.5 ohms

Dimensions (w/h/d) (Approx.)
220 × 395 × 325 mm (with foot)

Mass (Approx.) 5.6 kg

HT-SS100 only

- **Front speaker (SS-MSP36S)**

- **Surround speaker (SS-SRP36S)**

- **Center speaker (SS-CNP36)**

Center speaker Full range, magnetically shielded

Front/Surround speaker Full range

Speaker unit

Front/Surround speaker 65 mm, cone type

Center speaker 30 × 60 mm, cone type

Enclosure type

Front/Surround speaker

Bass reflex

Center speaker Acoustic suspension

Rated impedance 3 ohms

Dimension (w/h/d) (Approx.)

Front/Surround speaker 102 × 163 × 77 mm (with foot)

Center speaker 380 × 50 × 64 mm (with foot)

Mass (Approx.)

Front speaker 0.52 kg

Surround speaker 0.48 kg

Center speaker 0.38 kg

- **Subwoofer (SS-WP36)**

Speaker unit 160 mm, cone type

Enclosure type Bass reflex

Rated impedance 1.5 ohms

Dimensions (w/h/d) (Approx.)
220 × 395 × 325 mm (with foot)

Mass (Approx.) 5.6 kg

Supplied speakers

Front speaker (2)
Center speaker (1)
Surround speaker (2)
Subwoofer (1)

Supplied accessories

Operating Instructions (this manual)
Quick Setup Guide (1)
Speaker Stand Installation Guide (HT-SF100 only) (1)
FM wire antenna (1)
AM loop antenna (1)
Remote commander (RM-AAU058) (1)
R6 (size-AA) batteries (2)
Optimizer microphone (ECM-AC2) (1)
Speaker cords (5)
Foot pads

- Speakers
 - HT-SS100 only (20)
 - HT-SF100 only (4)
- Subwoofer (4)

Screws (small) (HT-SF100 only) (12)
Screws (large) (HT-SF100 only) (8)

For details on the area code of the component you are using, see page 3.

Design and specifications are subject to change without notice.

Halogenated flame retardants are not used in the certain printed wiring boards.

Index

Numerics

5.1 channel 12

A

AUTO CALIBRATION 23

B

Blu-ray disc player

connecting 18

playback 30

“BRAVIA” Sync

preparing 45

C

CD player

connecting 17

playback 31

D

Digital Cinema Sound

(DCS) 39, 53

DIGITAL MEDIA PORT

adapter

connecting 17

playback 31

DIMMER 38

DISPLAY 38

Dolby Digital 53

DTS 53

DVD player

connecting 18

playback 30

DVD recorder

connecting 18

playback 30

E

Error messages 59

H

HDMI

connecting 18

I

IN MODE 51

Initial setup 22

M

Menu

A.CAL 35

CUSTOM 38

LEVEL 37

SET HDMI 55

SP SETUP 36

TONE 37

Muting 29

O

One-Touch Play 46

P

Power Save 48

R

RDS 43

Remote commander 8

S

Satellite tuner/Set-top box

connecting 18

playback 30

Selecting

component 28

Sleep Timer 50

Sound fields

selecting 39

Speakers

connecting 15

installing 12

Super Audio CD player

connecting 17

playback 31

System Audio Control 47

System Power Off 48

T

TEST TONE 27

Tuner

connecting 21

Tuning

automatically 40

to preset stations 42

TV

connecting 16, 18

playback 29

V

VCR

connecting 20

playback 31

Volume Limit 47



* 4 1 3 0 0 2 9 1 3 * (1)