



SCC 2-Pump 12-Station Controllers

Part Number: 882.00249.00
Bulletin Number: CV3-650
Effective: 10/25/05

Write Down Your Serial Numbers Here For Future Reference:

_____	_____
_____	_____
_____	_____

We are committed to a continuing program of product improvement.
Specifications, appearance, and dimensions described in this manual are subject to change without notice.

DCN No. _____
© Copyright 2005
All rights reserved.

Please note that our address and phone information has changed. Please reference this page for updated contact information.



These manuals are obsolete and are provided only for their technical information, data and capacities. Portions of these manuals detailing procedures or precautions in the operation, inspection, maintenance and repair of the products may be inadequate, inaccurate, and/or incomplete and shouldn't be relied upon. Please contact the ACS Group for more current information about these manuals and their warnings and precautions.

Parts and Service Department

The ACS Customer Service Group will provide your company with genuine OEM quality parts manufactured to engineering design specifications, which will maximize your equipment's performance and efficiency. To assist in expediting your phone or fax order, please have the model and serial number of your unit when you contact us. A customer replacement parts list is included in this manual for your convenience. ACS welcomes inquiries on all your parts needs and is dedicated to providing excellent customer service.

For immediate assistance, please contact:

- North, Central and South America, 8am – 5pm CST +1 (800) 483-3919 for drying, conveying, heating and cooling and automation. For size reduction: +1 (800) 229-2919.
North America, emergencies after 5pm CST (847) 439-5855
North America email: acsuscanadacustserv@corpemail.com
- Mexico, Central & South America
Email: acslatinamericacustserv@corpemail.com
- Europe, Middle East & Africa +48 22 390 9720
Email: acseuropecustserv@corpemail.com
- India +91 21 35329112
Email: acsindiacustserv@corpemail.com
- Asia/Australia +86 512 8717 1919
Email: acsasiacustserv@corpemail.com

Sales and Contracting Department

Our products are sold by a worldwide network of independent sales representatives. Contact our Sales Department for the name of the sales representative nearest you.

Let us install your system. The Contract Department offers any or all of these services: project planning; system packages including drawings; equipment, labor, and construction materials; and union or non-union installations.

For assistance with your sales or system contracting needs please Call:

North, Central and South America +1 (262) 641-8600 or +1 (847) 273-7700 Monday–Friday, 8am–5pm CST

Europe/Middle East/Africa +48 22 390 9720

India +91 21 35329112

Asia/Australia +86 512 8717 1919

Facilities:

ACS offers facilities around the world to service you no matter where you are located. For more information, please visit us at www.acscorporate.com

United States:

ACS Schaumburg – Corporate Offices

1100 E. Woodfield Road
Suite 588
Schaumburg, IL 60173
Phone: + 1 847 273 7700
Fax: + 1 847 273 7804

ACS New Berlin – Manufacturing Facility

2900 S. 160th Street
New Berlin, WI 53151
Phone : +1 262 641 8600
Fax: + 1 262 641 8653

Asia/Australia:

ACS Suzhou

109 Xingpu Road SIP
Suzhou, China 215126
Phone: + 86 8717 1919
Fax: +86 512 8717 1916

Europe/Middle East/Africa:

ACS Warsaw

Ul. Działkowa 115
02-234 Warszawa
Phone: + 48 22 390 9720
Fax: +48 22 390 9724

India

ACS India

Gat No. 191/1, Sandbhor Complex
Mhalunge, Chakan, Tal Khed,
Dist. Pune 410501, India
Phone: +91 21 35329112
Fax: + 91 20 40147576

Shipping Information

Unpacking and Inspection

You should inspect your equipment for possible shipping damage. Thoroughly check the equipment for any damage that might have occurred in transit, such as broken or loose wiring and components, loose hardware and mounting screws, etc.

In the Event of Shipping Damage

According to the contract terms and conditions of the Carrier, the responsibility of the Shipper ends at the time and place of shipment.

Notify the transportation company's local agent if you discover damage

Hold the damaged goods and packing material for the examining agent's inspection. **Do not return any goods before the transportation company's inspection and authorization.**

File a claim with the transportation company. Substantiate the claim by referring to the agent's report. A certified copy of our invoice is available upon request. The original Bill of Lading is attached to our original invoice. If the shipment was prepaid, write us for a receipted transportation bill.

Advise customer service regarding your wish for assistance and to obtain an RMA (return material authorization) number.

If the Shipment is Not Complete

Check the packing list as back-ordered items are noted on the packing list. In addition to the equipment itself, you should have:

- Bill of lading
- Packing list
- Operating and Installation packet
- Electrical schematic and panel layout drawings
- Component instruction manuals (if applicable)

Re-inspect the container and packing material to see if you missed any smaller items during unpacking.

If the Shipment is Not Correct

If the shipment is not what you ordered, **contact the shipping department immediately**. For shipments in the United States and Canada, call **1 (630) 595-1060**; for all other countries, call our international desk at **(630) 595-1060**. Have the order number and item number available. *Hold the items until you receive shipping instructions.*

Returns

Do not return any damaged or incorrect items until you receive shipping instructions from the shipping department.

Credit Returns

Prior to the return of any material, authorization must be given by the manufacturer. A RMS number will be assigned for the equipment to be returned.

Reason for requesting the return must be given.

All returned material purchased from the manufacturer is subject to 15% (\$75.00 minimum) restocking charge.

All returns are to be shipped prepaid.

The invoice number and date or purchase order number and date must be supplied.

No credit will be issued for material that is not within the manufacturer's warranty period and/or in new and unused condition, suitable for resale.

Warranty Returns

Prior to the return of any material, authorization must be given by the manufacturer. A RMS number will be assigned for the equipment to be returned.

Reason for requesting the return must be given.

All returns are to be shipped prepaid.

The invoice number and date or purchase order number and date must be supplied.

After inspecting the material, a replacement or credit will be given, at the manufacturer's discretion, if the item is found to be defective in materials or workmanship. Purchased components are covered under their specific warranty terms.

Table of Contents

CHAPTER 1: SAFETY	6
1-1 How to Use This Manual	6
<i>Safety Symbols Used in this Manual</i>	6
1-2 Warnings and Precautions	7
1-3 Responsibility	8
<i>General Responsibility</i>	8
<i>Operator Responsibility</i>	9
<i>Maintenance Responsibility</i>	9
<i>Reporting a Safety Defect</i>	9
CHAPTER 2: FUNCTIONAL DESCRIPTION.....	10
2-1 Models Covered in This Manual	10
2-2 General Description.....	10
2-3 Standard Features.....	11
<i>Mechanical Features</i>	11
<i>Electrical Features</i>	11
<i>Controller Features</i>	11
2-4 Optional Features.....	11
2-5 Safety Devices and Interlocks	12
<i>Safety Circuit Standards</i>	12
<i>Fail Safe Operation</i>	12
<i>Safety Device Lock-Outs</i>	12
CHAPTER 3: INSTALLATION	14
3-1 Uncrating	14
3-2 Mounting the Control Panel.....	14
3-3 Electrical Connections.....	14
<i>Making Control Panel Power Drop Wiring Connections</i>	14
<i>Connecting the Control Panel to Vacuum Hoppers</i>	15
<i>Connecting the Control Panel to the Pump Package</i>	15
<i>Main Power</i>	17
3-4 Setup.....	17
<i>Gaining Access to the Menu System</i>	18
<i>Station Settings Menu</i>	19
<i>Pump Settings Menu</i>	27
<i>System Settings Menu</i>	32
<i>Service Settings Menu</i>	33
<i>Saving Controller Settings to Flash Memory</i>	33
3-5 Initial Startup	33
CHAPTER 4: OPERATION	34
4-1 Startup.....	34
<i>Setting Load Times</i>	34
<i>Enabling and Disabling Individual Stations</i>	35

4-2	Controller Description and Operation	35
	<i>Text Area</i>	35
	<i>Station Icons</i>	37
	<i>Status Indicators</i>	38
	<i>Controller Keypad</i>	39
4-3	Operation	40
	<i>Operation States</i>	40
4-4	Shut-Down	42
CHAPTER 5: MAINTENANCE		43
	<i>Updating BIOS Software</i>	43
CHAPTER 6: TROUBLESHOOTING		46
6-1	General Troubleshooting	46
	<i>Controller Recovery using Flash Memory Technology</i>	48
CHAPTER 7: APPENDIX		49
7-1	Warranty	49
	<i>Warranty Specifications</i>	49
	<i>Warranty Restrictions</i>	49
	<i>Warranty Liabilities</i>	50
	<i>Customer Responsibilities</i>	50
7-2	Drawings and Diagrams	51
7-3	Spare Parts List	52
7-4	Controller Identification (Serial Number) Tag	56
7-5	Technical Assistance (Contact Information)	56
	<i>Parts Department</i>	56
	<i>Service Department</i>	56
	<i>Sales Department</i>	56
	<i>Contract Department</i>	56
CHAPTER 8: SERVICE ONLY INFORMATION		57
8-1	Service Settings Menu	57
	<i>Setting the Ramp Up Time</i>	57
	<i>Setting the Ramp Down Time</i>	58
	<i>Setting the Pump Stage Time</i>	59
	<i>Setting the LCD Blink Delay</i>	60
	<i>Setting the Hi Vacuum Sensor Delay</i>	61
	<i>Setting the Hi Vacuum Vent Delay</i>	62
	<i>Setting the Hi Vacuum Load Count</i>	63
	<i>Using the Installation Aids Menus</i>	64
8-2	Other Controller Restricted Areas	67
	<i>Using the OEM Service Menu</i>	67
	<i>Recovering Passwords</i>	68
	<i>Restoring the Controller to Factory Defaults</i>	69

Chapter 1: Safety

1-1 How to Use This Manual

Use this manual as a guide and reference for installing, operating, and maintaining your equipment. The purpose is to assist you in applying efficient, proven techniques that enhance equipment productivity.

This manual covers only light corrective maintenance. No other maintenance should be undertaken without first contacting a service engineer.

The Functional Description section outlines models covered, standard features, and optional features. Additional sections within the manual provide instructions for installation, pre-operational procedures, operation, preventive maintenance, and corrective maintenance.

The Installation chapter includes required data for receiving, unpacking, inspecting, and setup of the equipment. We can also provide the assistance of a factory-trained technician to help train your operator(s) for a nominal charge. This section includes instructions, checks, and adjustments that should be followed before commencing with operation of the equipment. These instructions are intended to supplement standard shop procedures performed at shift, daily, and weekly intervals.

The Operation chapter includes a description of electrical and mechanical controls, in addition to information for operating the equipment safely and efficiently.

The Maintenance chapter is intended to serve as a source of detailed assembly and disassembly instructions for those areas of the equipment requiring service. Preventive maintenance sections are included to ensure that your equipment provides excellent, long service.

The Troubleshooting chapter serves as a guide for identification of most common problems. Potential problems are listed, along with possible causes and related solutions.

The Appendix contains technical specifications, drawings, schematics, and parts lists. A spare parts list with part numbers specific to your machine is provided with your shipping paperwork package. Refer to this section for a listing of spare parts for purchase. Have your serial number and model number ready when ordering.

Safety Symbols Used in this Manual

The following safety alert symbols are used to alert you to potential personal injury hazards. Obey all safety messages that follow these symbols to avoid possible injury or death.

Danger! *DANGER indicates an imminently hazardous situation which, if not avoided, will result in death or serious injury.*

Warning! *WARNING indicates a potentially hazardous situation or practice which, if not avoided, could result in death or serious injury.*

Caution! *CAUTION indicates a potentially hazardous situation or practice which, if not avoided, may result in minor or moderate injury or in property damage.*

Controller Safety Tags



High Voltage Inside
Enclosure



Read Operation and Installation
Manual

1-2 Warnings and Precautions

Our equipment is designed to provide safe and reliable operation when installed and operated within design specifications, following national and local safety codes. This may include, but is not limited to OSHA, NEC, CSA, SPI, and any other local, national and international regulations.

To avoid possible personal injury or equipment damage when installing, operating, or maintaining this equipment, use good judgment and follow these safe practices:

- ☑ **Read and follow these operation and installation instructions when installing, operating, and maintaining this equipment. If these instructions become damaged or unreadable, additional copies are available from the manufacturer.**
- ☑ Follow all **SAFETY CODES**.
- ☑ Wear **SAFETY GLASSES** and **WORK GLOVES**.
- ☑ Work only with approved tools and devices.
- ☑ Disconnect and/or lock out power before servicing or maintaining the equipment.
- ☑ Use care when **LOADING, UNLOADING, RIGGING, or MOVING** this equipment.
- ☑ Operate this equipment within design specifications.
- ☑ **OPEN, TAG, and LOCK ALL DISCONNECTS** before working on equipment. You should remove the fuses and carry them with you.
- ☑ Make sure the equipment and components are properly **GROUND**ED before you switch on power.
- ☑ Use extreme caution when working with your conveying system. **HIGH VACUUM** can be dangerous. Keep body parts, tools, clothing, and debris away from vacuum inlets.
- ☑ When welding or brazing in or around this equipment, make sure **VENTILATION** is **ADEQUATE**. **PROTECT** adjacent materials from flame or sparks by shielding with sheet metal. An approved **FIRE EXTINGUISHER** should be close at hand and ready for use if needed.
- ☑ Do not restore power until you remove all tools, test equipment, etc., and the equipment and related components are fully reassembled.
- ☑ Only **PROPERLY TRAINED** personnel familiar with the information in this manual should work on this equipment.

We have long recognized the importance of safety and have designed and manufactured our equipment with operator safety as a prime consideration. We expect you, as a user, to abide by the foregoing recommendations in order to make operator safety a reality.

1-3 Responsibility

These machines are constructed for maximum operator safety when used under standard operating conditions and when recommended instructions are followed in the maintenance and operation of the machine.

All personnel engaged in the use of the machine should become familiar with its operation as described in this manual.

Proper operation of the machine promotes safety for the operator and all workers in its vicinity.

Each individual must take responsibility for observing the prescribed safety rules as outlined. All warning and danger signs must be observed and obeyed. All actual or potential danger areas must be reported to your immediate supervisor.

General Responsibility

No matter who you are, safety is important. Owners, operators and maintenance personnel must realize that every day, safety is a vital part of their jobs.

If your main concern is loss of productivity, remember that production is always affected in a negative way following an accident. The following are some of the ways that accidents can affect your production:

- Loss of a skilled operator (temporarily or permanently)
- Breakdown of shop morale
- Costly damage to equipment
- Downtime

An effective safety program is responsible and economically sound.

Organize a safety committee or group, and hold regular meetings. Promote this group from the management level. Through this group, the safety program can be continually reviewed, maintained, and improved. Keep minutes or a record of the meetings.

Hold daily equipment inspections in addition to regular maintenance checks. You will keep your equipment safe for production and exhibit your commitment to safety.

Please read and use this manual as a guide to equipment safety. This manual contains safety warnings throughout, specific to each function and point of operation.

Operator Responsibility

The operator's responsibility does not end with efficient production. The operator usually has the most daily contact with the equipment and intimately knows its capabilities and limitations.

Plant and personnel safety is sometimes forgotten in the desire to meet incentive rates, or through a casual attitude toward machinery formed over a period of months or years. Your employer probably has established a set of safety rules in your workplace. Those rules, this manual, or any other safety information will not keep you from being injured while operating your equipment.

Learn and always use safe operation. Cooperate with co-workers to promote safe practices. Immediately report any potentially dangerous situation to your supervisor or appropriate person.

Maintenance Responsibility

Proper maintenance is essential to safety. If you are a maintenance worker, you must make safety a priority to effectively repair and maintain equipment.

Before removing, adjusting, or replacing parts on a machine, remember to turn off all electric supplies and all accessory equipment at the machine, and disconnect and lockout electrical power. Attach warning tags to the disconnect switch.

Be sure that all non-current carrying parts are correctly connected to earth ground with an electrical conductor that complies with current codes. Install in accordance with national and local codes.

When you have completed the repair or maintenance procedure, check your work, remove your tools. Rigging, and handling equipment.

Reporting a Safety Defect

If you believe that your equipment has a defect that could cause injury, you should immediately discontinue its use and inform the manufacturer.

The principle factors that can result in injury are failure to follow proper operating procedures (i.e. lockout/tagout), or failure to maintain a clean and safe working environment.

Chapter 2: Functional Description

2-1 Models Covered in This Manual

This manual provides operation, installation, and maintenance instructions for 2-Pump, 12-Station Conveying Controllers. Model numbers are listed on the serial tag. Make sure you know the model and serial number of your equipment before contacting the manufacturer for parts or service.

The 2-Pump, 12-Station Conveying Controller is a programmable logic controller, with 24 VDC or 115 VAC control circuit, easy-to-use 16-key operator interface keypad and optional audible/visual alarm.

2-2 General Description

Our systems create vacuum for the automatic pneumatic conveying of most free-flowing, dry, pelletized, or granular materials in a central material handling system. Material characteristics determine the type of equipment needed to convey the material.

A typical use for our equipment is an in-plant distribution system for plastic processing plants.

Our central vacuum systems are as varied as the applications they service. The tubing and equipment furnished in our system is designed to convey the material(s) specified at the time of purchase at specific rates and distances.

We can advise you on your system capabilities based on system makeup, distance, material, and conveying rates you want.

System capacity is directly affected by the pressure drop in the overall system, such as number of material line bends, pipe length, Y-tubes, T-tubes, etc.

Note: Vacuum leaks occurring anywhere in your system reduce capacity.

Use the minimum effective amount of vinyl flex hose to maximize material line efficiency. Keep material lines as straight as possible. Refer to the Mechanical Components Product manual (Part No. A0536580) for installation recommendations.

2-3 Standard Features

Mechanical Features

Time-fill Capability. The length of time a station's vacuum valve remains open to allow material to be drawn into its receiver.

Volume-fill Capability. The length of time a station's vacuum valve remains open to allow material to be drawn in. The vacuum valve will close when material covers the station's volume-fill proximity sensor or this time elapses, whichever comes first.

Pump Blowback Filter Cleaning Outputs. When this feature is enabled, the controller periodically sends compressed air backward through the pump's air filter to dislodge accumulated dust and debris.

Electrical Features

- 115/1/60 supply voltage
- 24 VDC control voltage
- Single-point power and ground connection
- Non-fused disconnect switch, lockable
- Branch circuit fusing
- Fully accessible NEMA 12-style electrical control enclosure

Controller Features

- Monitors Station status and Pump status
- Allows operator to transfer stations to a standby pump when a pump fails
- Electronic time delay between pump startups to prevent an excessive power demand at your facility

2-4 Optional Features

Options marked with "*" indicate options that can be factory installed or retrofitted in the field.

230/1/60 Operation. Required to operate with a 230/1/60 supply voltage.

Audible/visual alarm. Alarm light and horn assembly that can be remote mounted and wired into the controller to indicate an alarm condition.

CE Package for 220/1/50 Operation. Required in Europe and other areas that need 220/1/50 supply voltage.

2-5 Safety Devices and Interlocks

This section includes information on safety devices and procedures that are inherent to the Controller. This manual is not intended to supersede or alter safety standards established by the user of this equipment. Instead, the material contained in this section is recommended to supplement these procedures in order to provide a safer working environment.

At the completion of this section, the operator and maintenance personnel will be able to do the following:

- Identify and locate specific safety devices.
- Understand the proper use of the safety devices provided.
- Describe the function of the safety device.

Safety Circuit Standards

Safety circuits used in industrial systems protect the operator and maintenance personnel from dangerous energy. They also provide a means of locking out or isolating the energy for servicing equipment.

Various agencies have contributed to the establishment of safety standards that apply to the design and manufacture of automated equipment. The Occupational Safety and Health Administration (OSHA) and the Joint Industrial Council (JIC) are just a few of the organizations that have joined with the plastics industry to develop safety standards.

Every effort has been made to incorporate these standards into the design of the conveying system; however, it is the responsibility of the personnel operating and maintaining the equipment to familiarize themselves with the safety procedures and the proper use of any safety devices.

Fail Safe Operation

If a safety device or circuit should fail, the design must be such that the failure causes a “Safe” condition. As an example, a safety switch must be a normally open switch. The switch must be held closed with the device it is to protect. If the switch fails, it will go to the open condition, tripping out the safety circuit.

At no time should the safety device fail and allow the operation to continue for example, if a safety switch is guarding a motor, and the safety switch fails, the motor should not be able to run.

Safety Device Lock-Outs

Some safety devices disconnect electrical energy from a circuit. The safety devices that are used in this Controller are primarily concerned with electrical power disconnection.

WARNING! *Always disconnect and lockout all electrical power and pneumatic (i.e. compressed air) sources prior to servicing the 2-Pump, 12-Station Controller. Failure to do so may result in serious injury. No one but the person who installed the lockout may remove it.*



Chapter 3: Installation

3-1 Uncrating

2-Pump, 12-Station Controllers are shipped mounted on a skid, enclosed in a plastic wrapper, and contained in a cardboard box.

1. Pry the crating away from the skid.

Note: *Remove the nails holding the box to the skid and lift the box off carefully; avoiding staples in the 1' x 4' wood supports. Cut the steel banding.*

2. Use a pry bar to remove the blocks securing the unit to the skid.
3. Lift unit from sides. Lift slowly and only high enough to clear the skid. Use a pry bar if necessary to carefully remove the skid from the unit.
4. Lower slowly.

3-2 Mounting the Control Panel

Note: *Before you mount the panel, consider how you run wiring to the vacuum hoppers, the filter chamber atmospheric valve (if so equipped) and the pump motor starter(s), vacuum switch(es), and vent valve(s).*

Mount the panel on a flat, vertical area. It should be a visible area that gives your operator access to the control. The panel requires a low voltage power drop as listed on the serial tag.

3-3 Electrical Connections

Refer to local electrical codes, the schematic and connection diagrams supplied with this unit and the serial tag for wiring considerations. Run all wiring in conduit if codes require it.

Making Control Panel Power Drop Wiring Connections

Plug the power cord supplied with your unit into a properly grounded, 3-slot, 115/1/50-60 VAC or 230/1/50-60 VAC receptacle specified on the control panel serial tag. The control enclosure draws less than five (5) amps during normal operation at 115/1/50-60 VAC.

Caution! *We recommend that you protect PLC memory by providing the control panel with a dedicated circuit, a true earth ground, and a spike/surge protector.*

Connecting the Control Panel to Vacuum Hoppers

Refer to the wiring connection diagram in Figure 1 on the next page that applies to your application.

Note: *Wire size depends on control voltage, distance, number of vacuum hoppers, and the number of wires in each raceway. Consult a qualified electrician.*

1. On 24 VDC control voltage systems, run a common +24 VDC wire and a common 0 (zero) VDC wire from the controller to each vacuum hopper in the system.

Note: *For safety, make sure that the +24 volt line is fused. The size of the fuse depends on the number of stations installed.*

A 4 amp fuse is sufficient for a 12-station installation.

2. On all systems, run two wires to each vacuum hopper: one each from the controller to the Bin-Full switch (LS) and to the Atmospheric/Sequence-T solenoid (SOL) valve.
3. Make sure that the solenoid and the proximity switch (if supplied) on vacuum hoppers are the same voltage (24 VDC) as the control panel voltage. Consult the control panel serial tag and the solenoid valve nameplates.
4. Wire size depends on control voltage, distance, number of vacuum hoppers, and the number of wires in each raceway. *Consult a qualified electrician.*
5. Properly ground each hopper to reduce static build up generated by material conveying.

Connecting the Control Panel to the Pump Package

1. Wire the pump package motor starter coil (M) to the terminal provided in the control panel enclosure.
2. Wire the pump package vacuum relief valve solenoid (SOL A) to the terminal provided in the control panel enclosure.
3. Wire the pump package vacuum switch (VS) to the terminal located in the control panel enclosure.
4. On vacuum pumps with blowback, wire the pump package blowback solenoid (SOL B) to the terminal located in the control panel enclosure.
5. **On 24 VDC control voltage systems, run a common +24 VDC wire and a common 0 (zero) VDC wire from the controller to each pump package in the system.**

Figure 1: Typical 24-Volt Junction Box Wiring Diagram

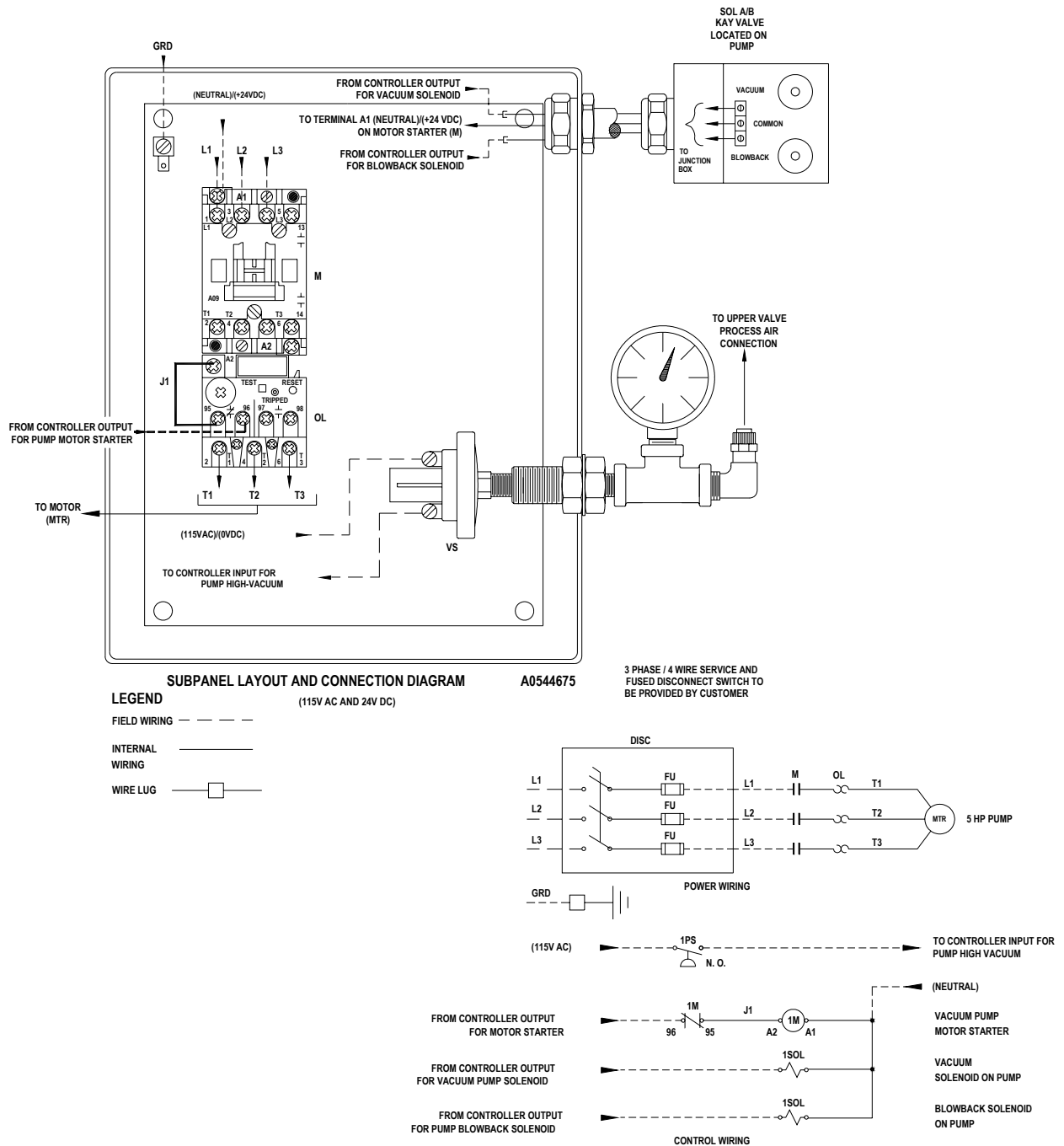

Main Power

Your 12-station controller system can operate from a 115 VAC or 220 VAC source at 50 Hz or 60 Hz. The main power switch on the controller is located on the right side of the housing. Built into the power switch are the controller fuses. Also, the configuration of the fuse holder determines the voltage setting of the controller (115/220 VAC).

Marked on the faceplate of the fuse holder shows the configuration for the desired voltage. Using a small screwdriver, remove the fuse holder. To select the operating voltage, align the arrow marker on the holder and the switch as shown in the following section.

The 12 station controller has a standard IEC power cord. Plug the cord into any standard 115 VAC outlet. If you selected the 220 VAC option, remove the end connector and install a standard 220 VAC plug. Doing so does NOT effect the controllers warranty.

DC Controller Power Sources

Although main controller power is 115/220 VAC, control power is actually unregulated 24 VDC. The 24 VDC control power supplies the power for all solenoids, sensors, and the controller itself. The unregulated supply can deliver up to five (5) amps of continuous current to drive a very large system.

Inputs

- Station connections
- High vacuum connections
- System error connections

Outputs

- Station connections
- Pump/blowback
- Spare

3-4 Setup

This section provides the procedures for configuring your 2-pump, 12-station controller.

Configuration of your controller includes setting the number of stations and pumps, setting variables such as convey time and blow-back interval, and setting up passwords. We recommend that you carry out these procedures in the order given here.

Note: *Before carrying out these procedures, install all equipment as described in this section and in the Mechanical Components manual.*

To help you set up the controller quickly, this section walks you through the setup using the menu system. This procedure will work for most applications, but you may need to perform some minor adjustments afterwards to achieve the best conveying performance.

Note: *The controller must be in Offline mode to permit access to the menu system.*

Gaining Access to the Menu System

To enter the menu system, make sure that the controller is in the OFFLINE state. Press the MENU key to initiate the menu system.

The menu has three (3) *top level* menus:

1. Station Settings
2. Pump Settings
3. System Settings

Press the CLEAR key in the menu system to bring you up one level.

Figure 2: Menu Tree Structure

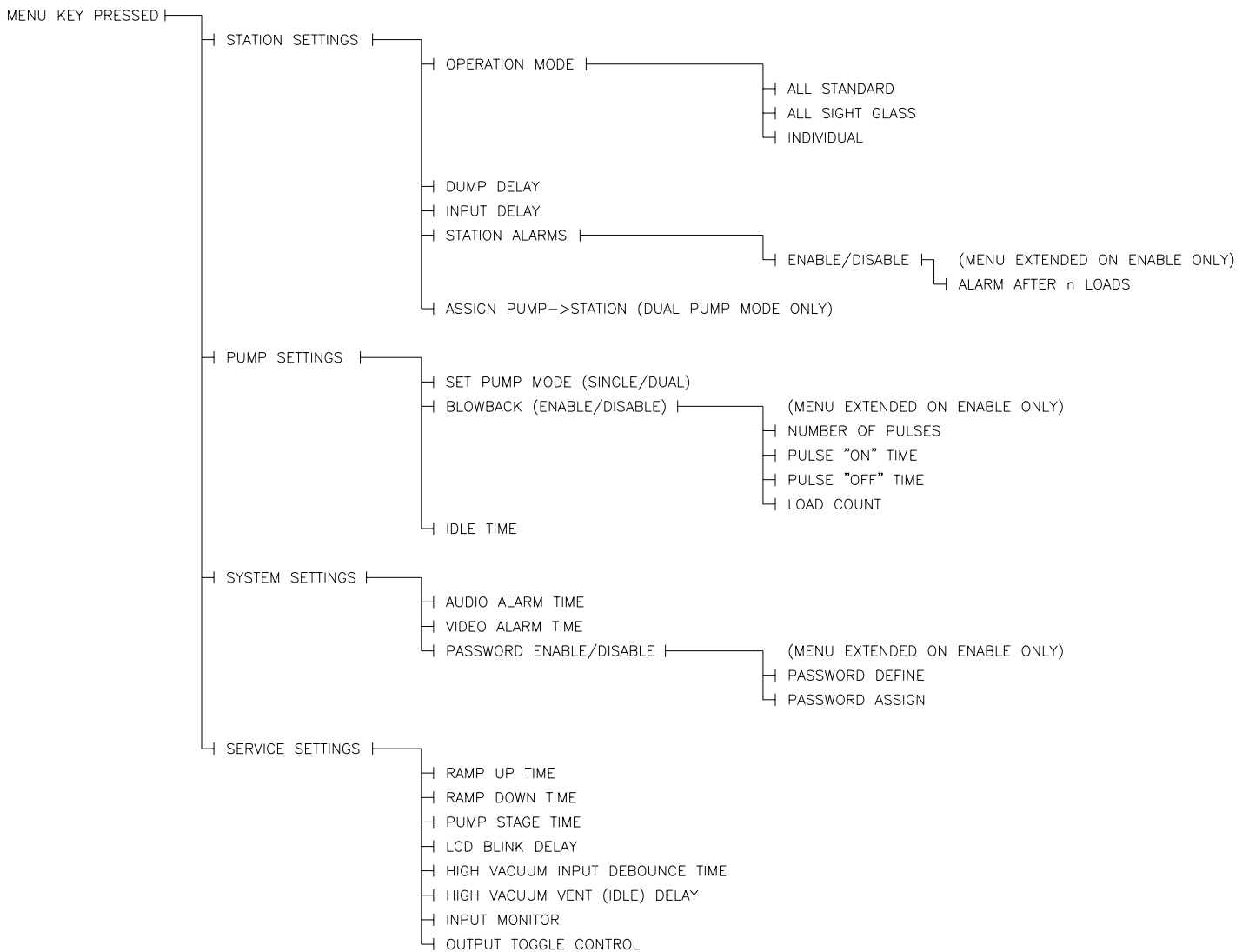

Station Settings Menu

To access the Station Settings menu, place the controller in the OFFLINE state:

1. Press the ENTER/MENU key to enter the menu system.
2. Continue to press the ENTER/MENU key until the following screen displays:

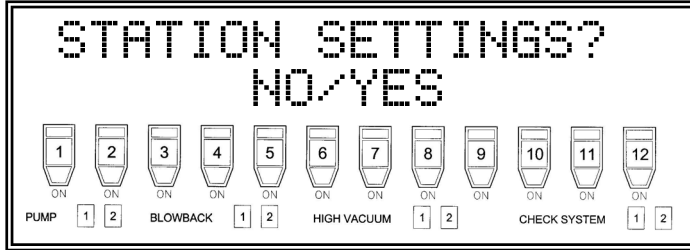

To enter the Station settings menu:

- Press the YES key.

To bring you up one level within any menu:

- Press the CLEAR key.

Operation Mode, Station Settings Menu

In most applications, each loading station can use different types of hoppers. The two common types are *standard hoppers* and *sight glass loaders*. You'll need to set up your controller for the type of hopper you are using for each of the 12 loading stations.

The first submenu in the Station Settings menu is the Operation Mode.

To enter the Operation Mode submenu:

- Press the YES key at the following screen prompt.

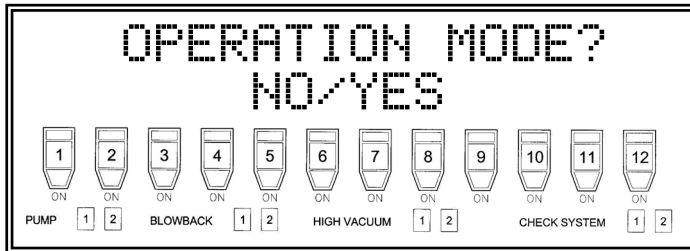

Each station in the conveying system can be a standard configuration or a sight glass configuration. Each hopper design operates in a slightly different manner.

In Standard mode, a flapper sensor detects a demand on the system. The volume fill sensor senses when the hopper is filled with material. These two (2) sensors are wired in series and a single input of the controller reads them. The controller determines the difference in the signals, depending on load sequence timing.

In Sight Glass mode, only one single sensor detects demand. This mode has no volume fill operation, and you'll need to disable that function. Properly setting the operation mode lets the controller correctly sequence station loading.

Upon entering the Operation Mode menu, the controller prompts you to set all 12 stations to Normal (default) mode.

To set all the stations to Normal mode and return to the Station Settings menu:

- Press the YES key at the following screen prompt.

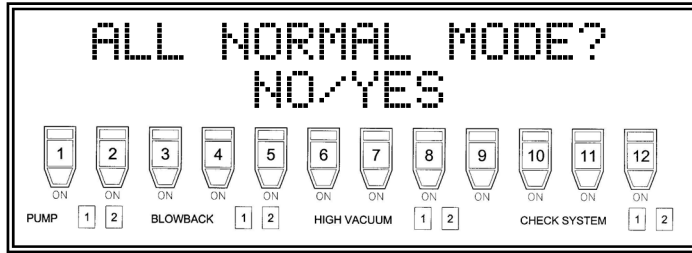

This function lets you use the fast setup feature of the controller. Normal mode is the factory default, so if no sight glass loaders are on your system, you won't need to alter this setting.

Pressing the NO key moves to the All Sight Glass Mode screen. Again, this function lets you quickly change all stations to Sight Glass mode *if all stations have sight glass loaders*.

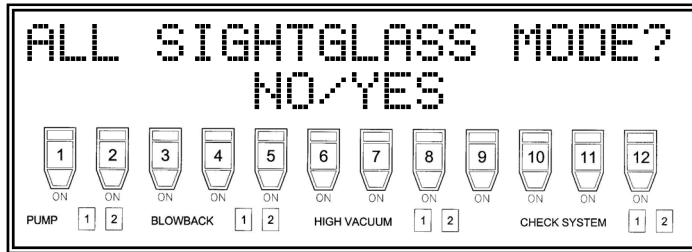

To move on to the individual settings screen:

- Press the NO key.

The following screen displays.

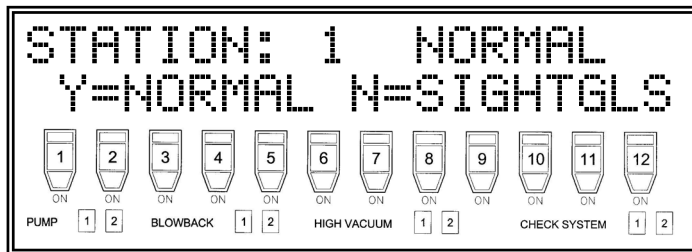

Starting with Hopper 1, the controller now lets you individually set the operation mode of each station.

1. Press the YES key to set the station to Normal mode.
2. Press the NO key to set the station to the Sight Glass mode.
3. Press the SET key to save the new setting into controller memory and increment to the next station in sequence.
4. Press the CLEAR key to exit to the Station Settings menu.

Set Dump Delay, Station Settings Menu

The second submenu in Station Settings is the Set Dump Delay submenu.

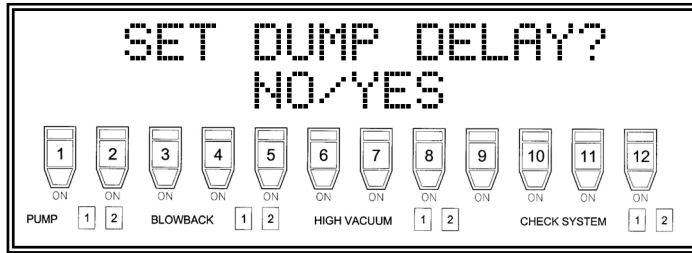

To set dump delay time:

- Press the YES key.

After a hopper finishes loading, the next hopper in the queue usually gets loaded. The time it takes to load the new hopper(s) usually gives ample time for the first hopper to dump its material. However, in a situation where a single hopper is being loaded, a demand may be generated during the dump cycle from material catching on the flapper switch. This may cause an inadvertent load while the hopper is still dumping material.

To prevent this from occurring, a dump delay timer starts after each hopper loads. The controller then waits until the timer elapses before loading the station. **Setting this timer is critical to an efficiently operating conveying system.** If you set the timer too short, inadvertent loads result. If you set the timer too long, unnecessary sequence delays occur.

To determine the proper setting, fill the hopper with material and measure the time it takes to dump the material. Add one second (1 sec.) for smaller hoppers and three seconds (3 sec.) for larger hoppers to this time. Enter the setting into controller memory using the following procedure. You may have to adjust the time setting for the best overall system efficiency.

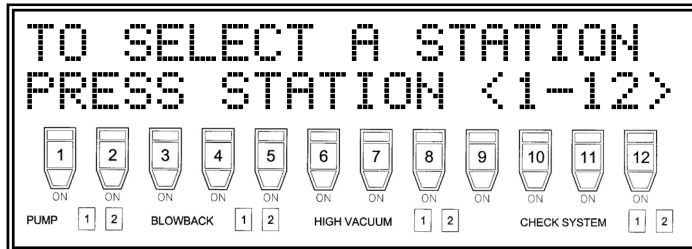

To alter station dump delay time:

- Select the station requiring the dump delay time change, and press the related Station ST nn key. nn is the number of the station you want to alter.

The following screen displays.

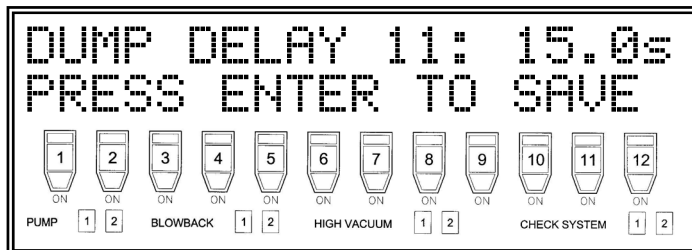

The screen displays the station you selected (11 in the above example), and the current dump delay time setting. Using number keys 1 to 0, enter the new dump delay time (in seconds) into controller memory. Keep in mind that the value shifts to the left as you enter. Use the 0 key to shift to the next multiple of ten.

To exit from the Dump Delay menu and return to the Station Settings menu:

- Press the CLEAR key.

To save the new value and escape from the Dump Delay menu:

- Press the ENTER key.

To save the new value to the controller memory and increment to the next station in the sequence:

- Press the SET key.

If you press the SET key without entering a value, the original value is retained and the controller moves to the next station in the sequence.

Set Input Delay, Station Settings Menu

The third submenu under Station Settings is the Set Input Delay submenu.

To set input delay time:

- Press the YES key.

The following screen displays.

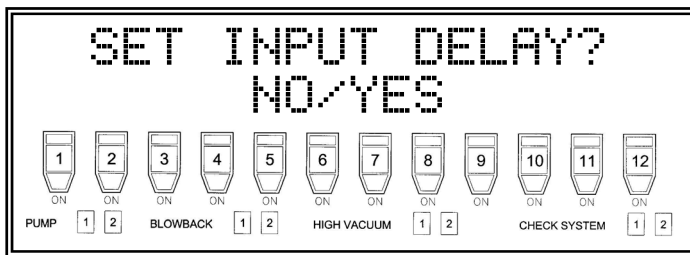

The Input Delay function protects the system from erroneous inputs caused by noise or mechanical vibration. The signal must be present for the input delay time setting duration for the input to be recognized.

To alter input delay time:

- Press the YES key.

The following screen displays.

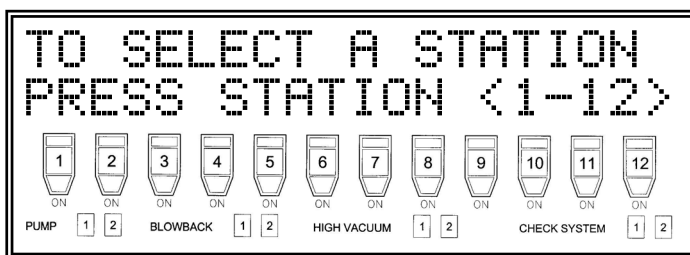

To alter station input delay time:

- Select a station to alter, then press the related Station ST nn key. nn is the station number you selected.

The screen displays the selected station (11 in the following example) and the current input delay time setting.

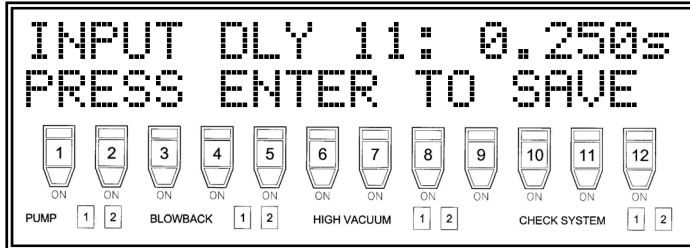

- Using number keys 1 to 0, enter the new time in seconds into controller memory. Keep in mind that the value shifts to the left as you enter it. Use the Zero 0 key to shift to the next multiple of ten.

To exit from the Input Delay time menu and return to the Station Settings menu:

- Press the CLEAR key.

To save the new value and escape from the Input Delay menu:

- Press the ENTER key.

To save the new value to the controller memory and increment to the next station in the sequence:

- Press the SET key.

If you press the SET key without entering a value, the original value is retained and the controller moves to the next station in the sequence.

Set Station Alarms, Station Settings Menu

The fourth submenu under Station Settings is the Set Station Alarms submenu.

To set station alarms:

- Press the YES key.

The following screen displays.

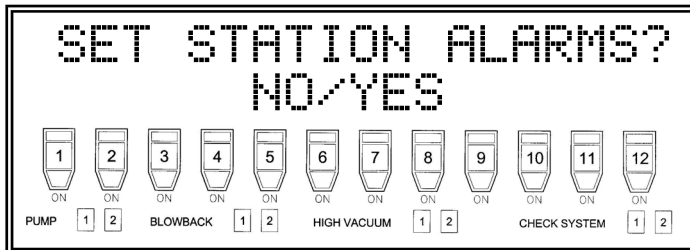

Each station has its own No Convey alarm settings. You can enable or disable alarms as needed. If a station doesn't receive (or dump) material after a user definable number of load attempts, the controller activates an alarm condition. Perform the following procedure to set alarm conditions.

To alter the Input Delay time:

- Press the YES key.

The following screen displays.

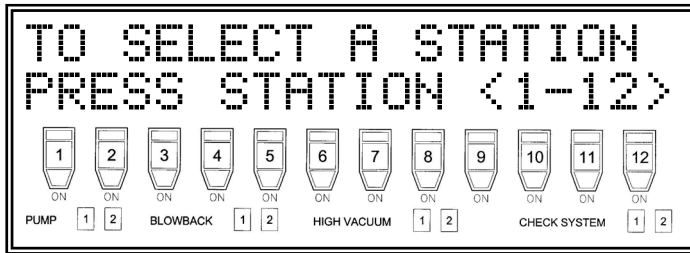

To alter stations alarm settings:

- Select a station to alter, then press the related Station *STnn* key. *nn* is the station number you selected.

The screen displays the selected station (11 in the following example) and the current station alarm setting.

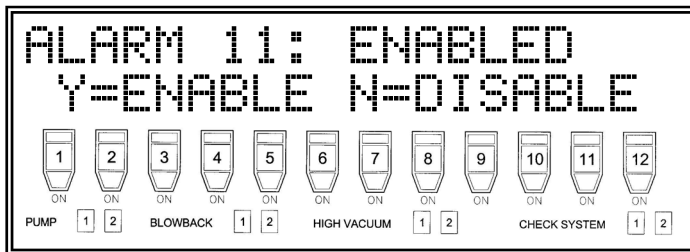

To enable the alarm:

- Press the YES key.

The alarm is enabled on the station you selected.

If you want to disable the alarm:

- Press the NO key.

The alarm is disabled on the station you selected.

The controller increments to the next station in sequence.

To retain the original setting:

- Press the SET key.

The next station in the sequence displays.

To exit from the Alarm Setting time menu and return to the Station Settings menu:

- Press the CLEAR key.

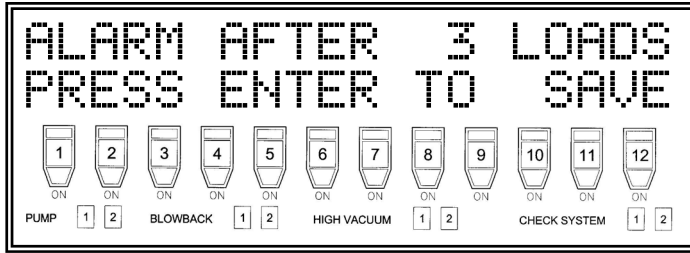

Assigning a Pump to a Station

This function lets you easily set all 12 stations.

From the main operating screen:

1. Press the MENU key until the following screen displays:

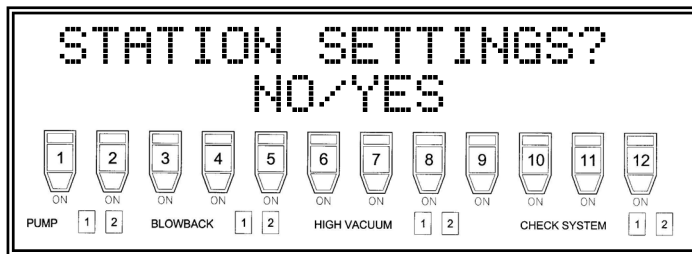

To enter the Station Settings menu:

1. Press the YES key.
2. Press the MENU key again until the following screen displays:

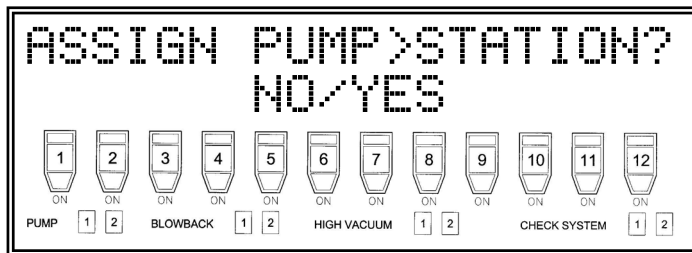

To assign pumps to stations:

1. Press the YES key.

The following screen displays:

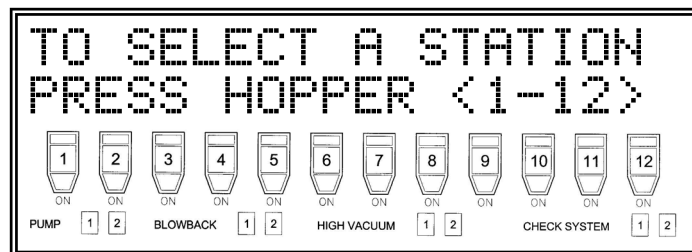

To assign a station to a pump:

1. Press the related station ST key.

The following menu screen displays:

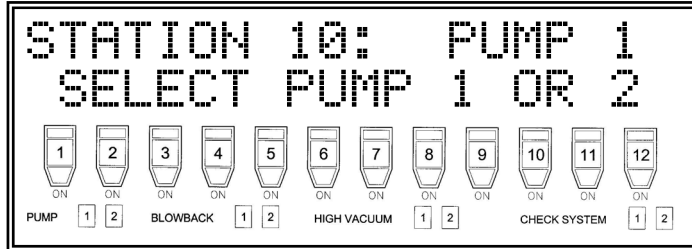

To assign Pump 1 to the station you selected:

- Press 1.

Instead of assigning Pump 1 to the station you selected, you can assign Pump 2:

- Press 2.

To save the new setting and display the Station Assignment screen:

- Press the ENTER key.

To save the new pump assignment and increment to the next station sequence:

- Press the SET key.

To exit the Station Settings menu:

1. Press the CLEAR key.
2. Press the CLEAR key repeatedly to exit to the next higher menu, or to exit the menu system.

Caution! *You must assign the correct pump to a hopper before starting the conveying process.*

Failure to properly assign pumps can result in damage to the conveying system!

Pump Settings Menu

The Pump Settings menu lets you set all pump parameters. These include:

- Pump Mode
- Blowback
- Delay Time

Setting the Pump Mode

The first setting to be configured is the *Pump mode*. This function tells the controller how many pumps are connected to the system and how the pumps are to be controlled.

You can select two pump modes: *Single Pump mode* and *Dual Pump mode*. In Single Pump mode (default), one (1) pump is used to convey material to all 12 stations. In Dual Pump mode, two (2) pumps are used simultaneously, resulting in a more efficient conveying process.

From the main operating display (OFFLINE):

1. Press the MENU key repeatedly until the screen displays the following:

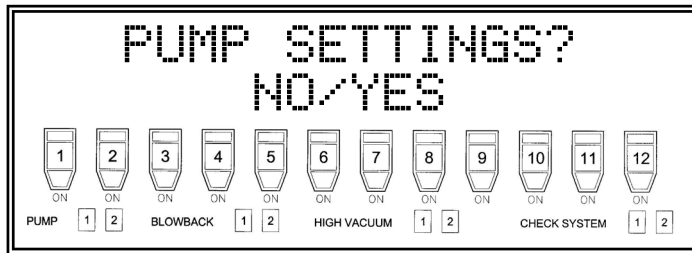

To enter the Pump Settings menu:

1. Press the YES key.
2. Press the NO or MENU key repeatedly until the screen displays the following:

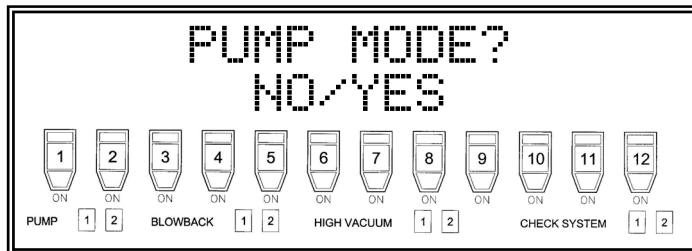

To enter the Pump Mode setting menu:

1. Press the YES key.

The screen displays the following:

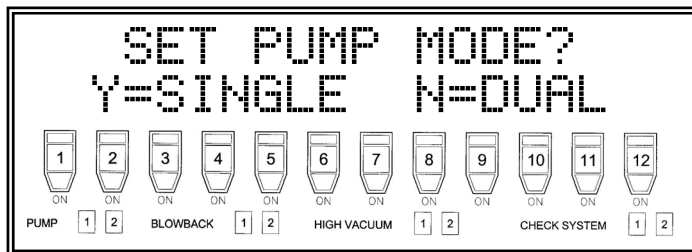

If you have a single pump system (default):

1. Press the YES key.

Selecting Single Pump mode requires the assignment of the default pump; the screen then displays the following:

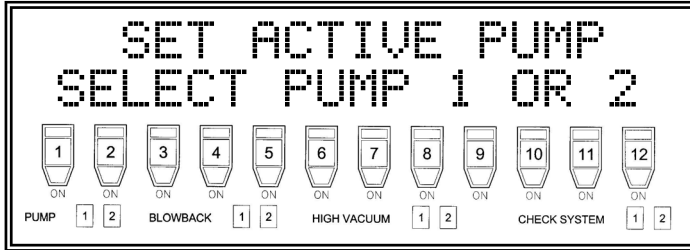

Selecting Dual Pump mode requires ALL stations to be assigned to a pump. Do so in the Station Settings Menu.

The pump mode is now set.

To exit from the Pump Settings Menu:

1. Press the CLEAR key.

Note: *You can always press the CLEAR key repeatedly to bring you up one level in the menu system.*

Selecting the Dual Pump option immediately returns you to the Pump Settings menu.

Caution! *If you select Dual Pump mode, you MUST assign each station to a pump. Each station defaults to Pump 1 if not assigned.*

Caution! *Not assigning a station to its related pump can cause damage to the loading system!*

Changing Blowback Settings, Pump Settings Menu

As an option, you can equip the conveying system filter chamber with a *blowback* feature to pulsate compressed air through the filter. This function cleans the filter after a pre-set number of load sequences.

To set up the controller blowback feature, enter the Pump Settings menu, then:

- Press the MENU key until the Blowback Settings prompt screen displays:

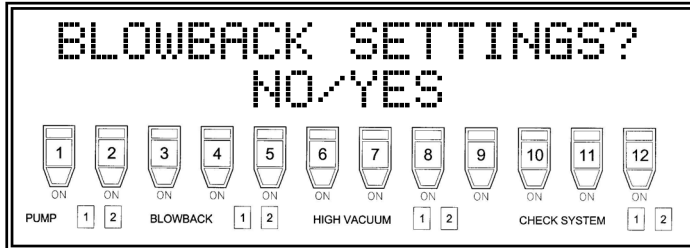

- Press the YES key to alter the blowback settings.

The following screen displays.

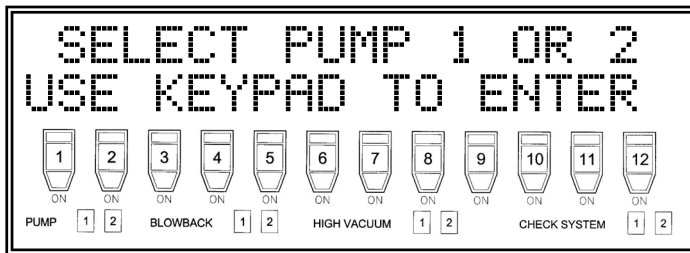

Each pump can have separate blowback settings. To alter pump settings, select a pump:

- Using the keypad, enter the pump number (1 or 2).

The following screen displays.

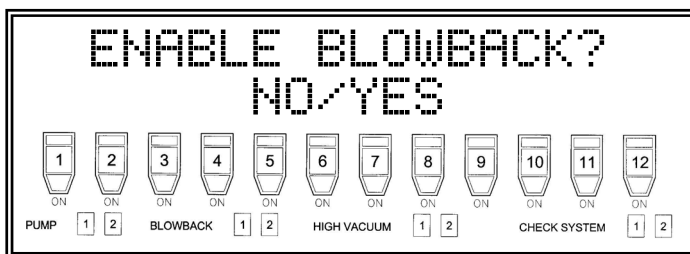

To disable the blowback feature:

- Press the NO key.

The screen returns to the Pump Settings menu.

If you want to enable the blowback feature:

- Press the YES key.

The screen continues to the next prompt.

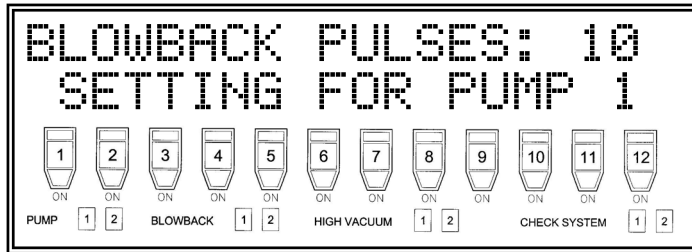

The first setting for the blowback feature is the number of blowback pulses. This setting determines the number of pulses of air that will be pushed through the filter during the blowback cycle. It has a range of 1 to 99, with a factory default of ten (10) pulses.

- Using the number keys, enter the new blowback pulse setting, then press ENTER to save the new value.

To save the current set value and move to the next menu item:

- Press ENTER without entering a value.

If a value is entered beyond the limits such as less than 1 or greater than 99, the screen displays question marks ?? in the settings area. If this happens:

- Simply re-enter the new value or press CLEAR to restore the value to the original setting.

If you've properly entered the value, the following screen displays.

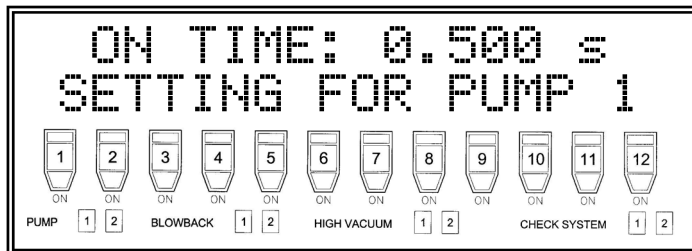

Next, set the Pulse On time value. This is the duration that the blowback solenoid is turned ON.

- Using the number keys, enter the new On Time setting, then press ENTER to save the new value.

To save the current On Time setting and move to the next menu item:

- Press ENTER without entering a value.

The following screen displays.

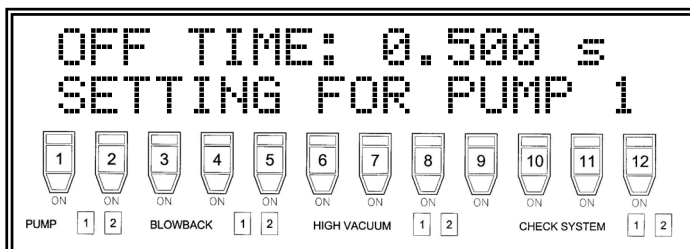

Next, set the Pulse Off time value. This is the duration that the blowback solenoid is turned OFF.

- Using the number keys, enter the new Off Time setting, then press ENTER to save the new value.

To save the current Off Time setting and move to the next menu item:

- Press ENTER without entering a value.

The following screen displays.

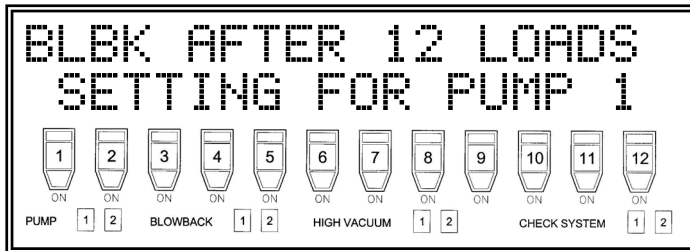

The last blowback setting tells the controller how many loads on stations assigned to the selected pump must be completed before starting a blowback cycle.

After you define this setting, the controller returns to the Pump Settings menu screen.

Idle Delay Time Settings, Pump Settings Menu

After a station load is complete, the controller looks for a new demand on the system. If all stations are satisfied with material, the controller enters IDLE (No Activity) state. During this state, the atmospheric vent valve is open and vacuum vents. During IDLE (No Activity) state time, the controller monitors inputs looking for a demand on the system. Eventually, if no demand is on the system, the controller shuts down the pump(s) and waits for a demand signal. This process saves energy and prolongs the life of the vacuum pump.

The Idle time is the length of time in which the controller waits with no demand until the pump is turned off.

To set up the controller Idle Delay time, enter the Pump Settings menu, then:

- Press the MENU key until the Idle Delay Time prompt screen displays as follows:

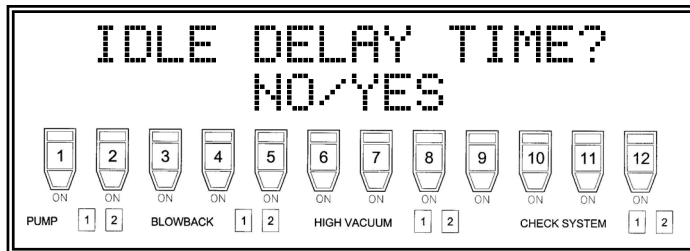

- Press the YES key to alter the Idle Delay time.

The following screen displays.

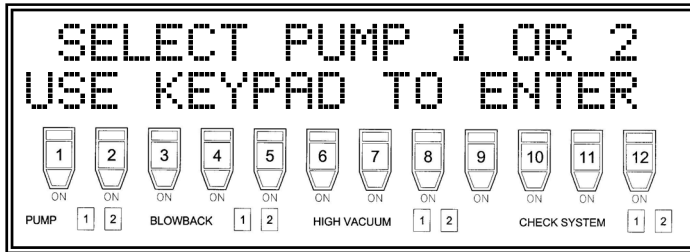

Each pump can have separate idle delay times. To alter idle delay, select a pump:

- Using the keypad, enter the pump number (1 or 2).

The following screen displays.

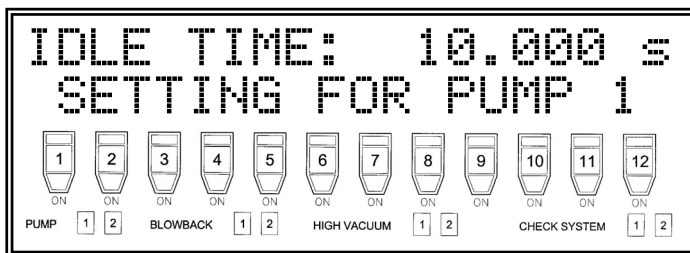

- Using the keypad, enter the idle delay time.

The controller is now properly set up and ready for operation.

System Settings Menu

Audio Alarm Time

Video Alarm Time

Password Enable/Disable

Service Settings Menu

The settings in this menu are not meant to be modified by floor personnel (operators). See the section at the end of this manual for these settings.

Saving Controller Settings to Flash Memory

Your 12 station controller uses a new technology called *flash memory*. This type of memory writes and reads like normal memory, but the advantage is that the data is retained *after power is shut down*. If you alter any parameter, the controller saves the new data to flash memory. This procedure takes several seconds and takes all the processor time. For this reason, the controller does not write to flash memory while running. Any changes to load times are saved when you press the STOP key and the controller shuts down completely.

Note: *Let the controller save parameter changes to flash memory completely before you shut down the controller.*

It is also possible for a write error to occur during this operation. If this occurs, the system always saves a backup of the data. See the Maintenance Section for instructions on how to restore the previous settings.

3-5 Initial Startup

Chapter 4: Operation

4-1 Startup

????????????????

Setting Load Times

You can alter load times anytime while not in the menu system by pressing the SET key. The controller screen then prompts you to select the station you want to alter:

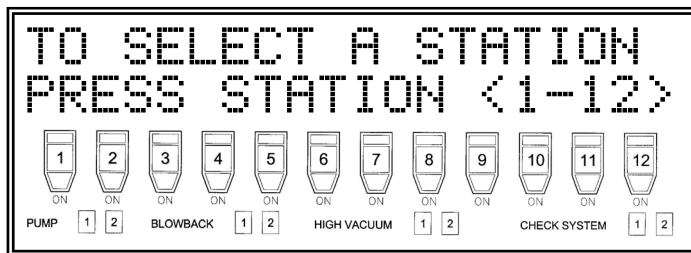

To select a station to alter:

1. Press the related station ST key of the station you want to alter.
The screen prompts you to enter a load time in seconds.

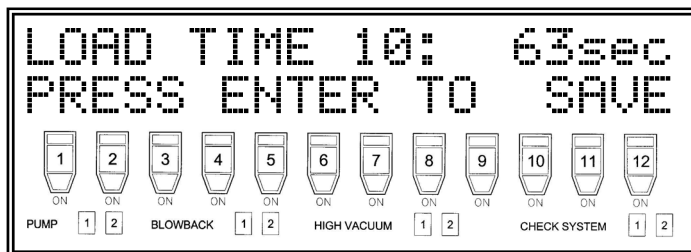

2. Using number keys 1 to 0, enter the new time.
3. Press the ENTER key to save the new setting into controller memory.

If several stations require altering:

1. Press the SET key instead of the ENTER key.

The new settings are saved and the station number increments to the next station in sequence.

Press the SET key without entering a value to retain the original value in controller memory.

The load time range of the station is from 1 to 360 seconds. Entering values beyond this range result in the screen displaying three (3) question marks (???).

To abort this erroneous entry and return to normal operation mode:

1. Press the CLEAR key.

Enabling and Disabling Individual Stations

Except while you are in the menu system and when you are altering system parameters, you can enable or disable any station in the system.

To enable or disable a loading station:

1. Press the ST mn key (where mn is the station number you want) to toggle between station enable or disable mode.

4-2 Controller Description and Operation

Your 12-station controller system has been designed for quick setup and easy, low maintenance operation. Before you begin operation, make sure you become familiar with the functions and features of your controller.

The controller screen displays the status of the controller at any given time. By a simple glance, you can know exactly what the controller is doing. The screen has three areas:

- *Text area*, a 2-line, 20-character screen
- *Station icons* for displaying the status of each individual station
- *Status indicators* for displaying the operation of the pump.

Text Area

The text area is separated into four (4) sections. The appearance of the screen depends on the setting of the *Pump mode*.

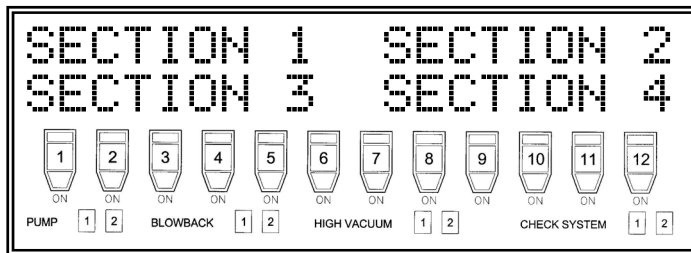

Pump Modes

Single Pump Mode

In *Single Pump mode*, the screen displays as shown below. The upper left corner displays the active station being loaded. If the system has no active station, two (2) hyphens “--” in the station area display. The lower left corner displays the load time in seconds. When a station is loading, this area displays how much time elapses during the load cycle. If no station is active, three (3) hyphens “---” display.

The upper right area displays the *status* of the control. This section displays the condition of the controller, and what action is occurring in the loading sequence. The different status displays are described on [Pages 24 and 25](#).

The lower right section of the display is not used in Single Pump mode. It simply displays the manufacturer’s logo.

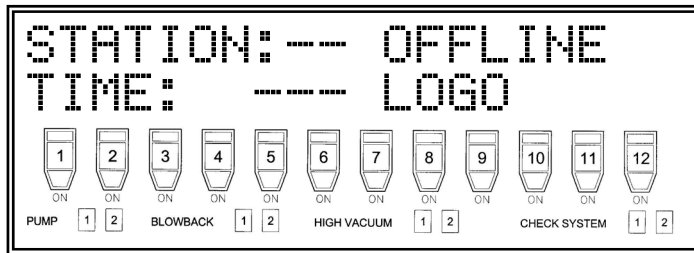

Dual Pump Mode

In *Dual Pump mode*, the screen displays as shown on the following page. The first line of the screen displays information for Pump 1 and the second line of the screen displays information for Pump 2.

Each line has twenty (20) characters divided into two (2) groups of ten (10). From the left character position, P0 S:--:--- is read as “Pump 0 Station --:Load Time ---.” This screen displays important information in an easy-to-read display. The right ten (10) character group displays the status of the specific pump. Again, the different status displays are described on [Pages 24 and 25](#).

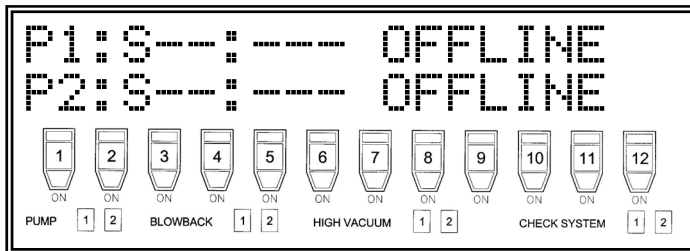

Station Icons

Below the text portion of the screen, 12 station icons display the status of each station in the system. Each station icon contains four segments.

Figure 3: Station Icon Segments

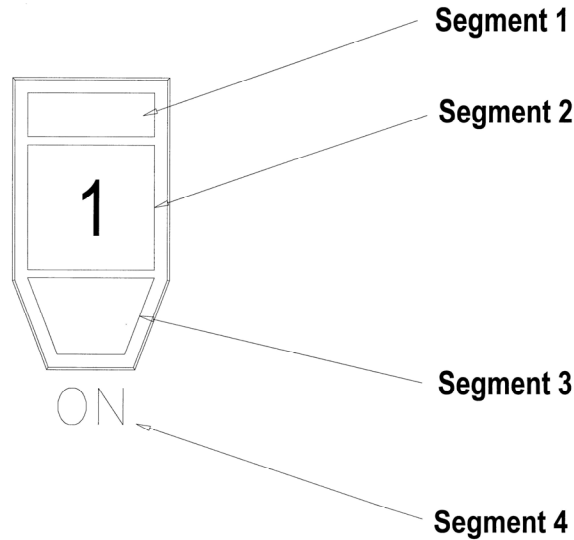









Label	Description
Segment 1	The top segment indicates the status of the valve above each station. When the valve is open (control output energized), this icon highlights. In Single Pump mode, only one valve indicator is active at a time. In Dual Pump mode, up to two valve indicators can be active at a time. When this indicator flashes, it indicates the assignment of a <i>priority convey</i> .
Segment 2	The center square segment indicates the existence of a station specific alarm condition. The alarm is typically related to a No Convey condition, but can also indicate the station with a high vacuum condition.
Segment 3	Located on the bottom of the station icon, the lower segment indicates the station demand input. This is a <i>real time</i> indicator, displaying when the station demand input is active. This indicator may toggle on and off during the load cycle, and should be considered normal.
Segment 4	Segment 4 is the indicator word ON, located below the station icon. When ON displays, the related station loads when the system senses a demand signal. When ON does not display, the station demand input signal is ignored and the related station does not load. Segment 4 blinks with Segment 2 in a high vacuum condition.

Status Indicators

Four (4) status indicators are located below the station icons at the bottom of the display. These indicators include PUMP, BLOWBACK, HIGH VACUUM, and SYSTEM. Each icon word has a 1 and a 2 icon with it, indicating Pump 1 or Pump 2.

Figure 4: Status Indicator Icons

Icon	Label	Description
PUMP  	Pump Status Indicator	The PUMP status indicator specifies an active pump. PUMP displays when any pump is active, and the 1 or 2 icon indicates which (or both) pump is active.
BLOWBACK  	Blowback Indicator	When enabled during the Blowback sequence, the BLOWBACK icon displays. The 1 or 2 icon indicates the activity of the blowback solenoid.
HIGH VACUUM  	High Vacuum Indicator	The High Vacuum indicator displays when a high vacuum condition is present. The 1 or 2 icon indicates the pump that has the high vacuum condition. The Alarm icon (Segment 2) and the ON icon (Segment 4) flash at the hopper with the high vacuum condition.
CHECK SYSTEM  	Check System Indicator	The Check System indicator displays any system errors. Three input for each pump, when active, prompts the CHECK SYSTEM icon to display. The 1 or 2 icon indicates which pump has the System input(s) active. System errors can include Dirty Filter, ... are common uses for these inputs.

Controller Keypad

Your 12-station controller has a 16-position keypad to let you operate and alter controller parameters. With the exception of the SET key, each key has at least two functions. The status of the controller determines what function is recognized.

Figure 4: Controller Keypad

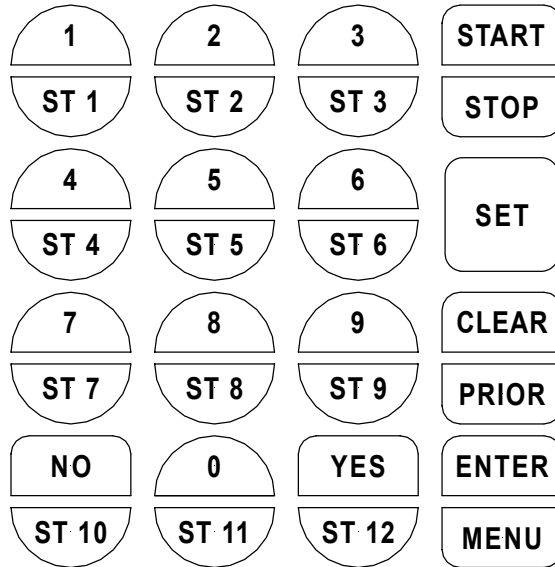

Key Descriptions

Label	Description
Number Keys	Use the ten (10) numeric keys marked 1 to 0 to enter numerical information on the controller.
Station Keys	Press one of the 12 station keys marked ST1 to ST12 to select or activate the specific station or hopper you want.
Start/Stop Key	Press the START/STOP key once to start the loading sequence. Press the START/STOP key again to <i>stop</i> the loading sequence.
Set Key	Press the SET key to set hopper loading times. Using the SET key also permits you to increment through each of the twelve (12) stations/hoppers when setting loading times. Press the SET key to save the updated value of the parameter you set, then increments to the next station.
Clear/Prior Key	Press the CLEAR/PRIOR key to initiate the priority convey sequence; this key also acts much like an escape key.
No/Yes Keys	Press the NO or YES keys to answer questions or prompts while you are using the menu system.
Enter/Menu Key	Press the ENTER/MENU key to save any data you entered in the controller memory. You can also press the key to let you enter the menu system.

4-3 Operation

Your 12 station controller electrically controls valves and solenoids to convey material from a central location to individual stations as needed. The controller works within this process by sensing a material demand and responds in a timely fashion to that demand.

An active signal sent from a demand sensor prompts the controller to place the station in a *demand queue*. The controller responds to this condition by loading the stations in a first come, first served basis. This is the most efficient manner of conveying material to different-sized stations.

The basic sequence of a normal load operation is:

1. Sense the demand from a station.
2. Add that station demand into the queue.
3. When required, remove the station from the queue.
4. If required, start the vacuum pump.
5. Open the sequence valve.
6. Load the station until the volume sensor activates or load time expires.
7. Close the sequence valve.
8. Continue on to load the next station in the queue.
9. If no demand is present in system after a short delay, then shut down the system vacuum pump.

Operation States

Label	Description
OFFLINE	The OFFLINE operation state is the default state at the point when you apply power to the controller. While in this state, all outputs in the system are deactivated and access to the menu system is permitted. All station demands are ignored.
IDLE (Startup)	<p>If you press the START/STOP key in the OFFLINE state, the controller enters the IDLE (Startup) state. If no demand is on the system, the controller immediately enters the READY state. With a valid demand, the IDLE (Startup) state allows the pump to get up to speed before starting to load a station.</p> <p>While in the IDLE (Startup) state, all station sequence valves are closed and the vent valve is open. The vent valve allows the vacuum pump to vent to atmosphere, keeping the system from becoming depressurized.</p>

Label	Description
LOADING	<p>Following the IDLE (Startup) state, the vent valve is closed and the first station in demand loads when that station sequence valve opens. This is the LOADING state. You can define load times for each station. The controller loads the station in demand until one of the two events below occur:</p> <ol style="list-style-type: none"> 1. The volume fill sensor becomes active. 2. The load time is exhausted. <p>At the end of the LOADING cycle, the controller closes the sequence valve and continues to the next station in the queue. If all stations are satisfied, the controller enters the IDLE (No Activity) state.</p>
IDLE (No Activity)	<p>The IDLE (No Activity) state acts as an energy saver and pump lifetime extender. During this state, the atmospheric valve is open, allowing the vacuum to be vented. All sequence valves are closed and all inputs are monitored for demand activity. This feature reduces repeated starting and stopping of pumps, extending pump operation life.</p> <p>If the controller senses a demand during the IDLE (No Activity) state, the controller re-enters the LOADING state by closing the vent valve and opening the sequence valve of the station in demand.</p> <p>If no demand exists in the system for the duration of the IDLE (No Activity) time setting, the controller then enters the READY state.</p> <p style="text-align: center;"><i>Note: IDLE is any condition in the conveying system when the pump runs but no station loads.</i></p>
READY	<p>The READY state is a monitoring function. All outputs are off and the controller waits for a demand signal to be fulfilled. If the controller senses a demand condition, the controller then re-enters the STARTING state and returns to load material into the hoppers.</p>
BLOWBACK	<p>When enabled, the controller enters the BLOWBACK state following a user-definable number of station loads. The blowback function is to pulse air through the filter system to keep the filter from clogging. The number and duration of the air pulses is also user-definable; see the Blowback menu on Pages 54-58 for more information.</p>
LOADING/IDLE (2 Pump Mode Only)	<p>In Dual Pump mode, if you start the controller with demand from stations assigned to both pumps, both pumps start at the same time. In many plants, such a resulting power surge can momentarily exceed the electrical limits of the plant. To prevent this condition, the pumps are staged in sequence separated by a short duration. Pump 1 always starts first, followed by Pump 2.</p> <p>This state also applies when both pumps are in the OFFLINE state and demand occurs on both systems at the same time.</p>

4-4 Shut-Down

Chapter 5: Maintenance

Updating BIOS Software

Occasionally, BIOS software updates are available to enhance the operation of the controller. These updates are available through the Service Department or for download from the internet. To find out what the current BIOS software version is, call the Service Department for details.

You can update the software with a laptop computer and an RS-232 serial connection through the COM1 serial port. As shown in the electrical diagrams and the electrical diagram on the following page, connect a serial cable as shown. Follow the installation program instructions supplied with the software update. The installation program automatically updates the BIOS.

Figure 5: BIOS Connection, Electrical Diagram; Drawing 1

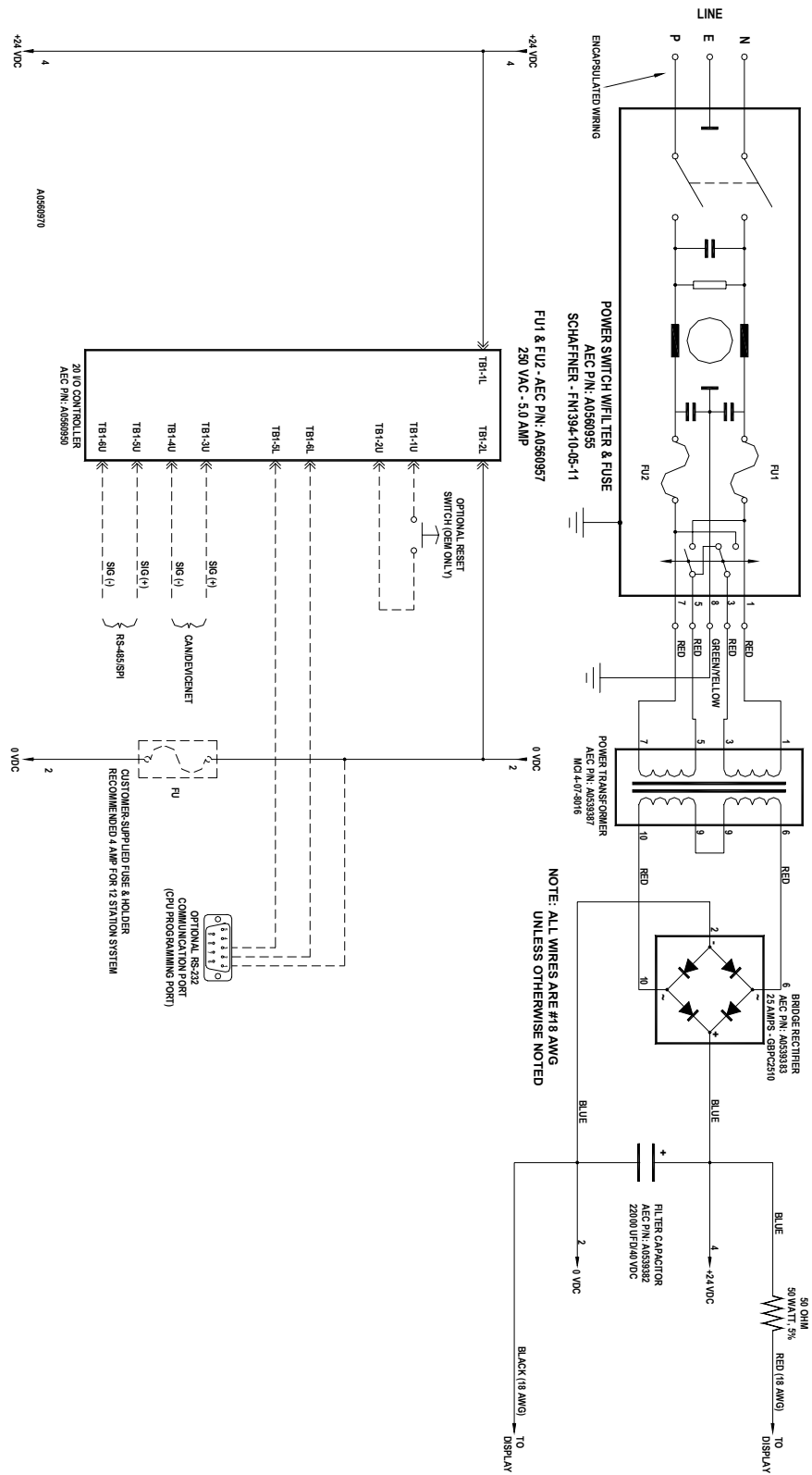
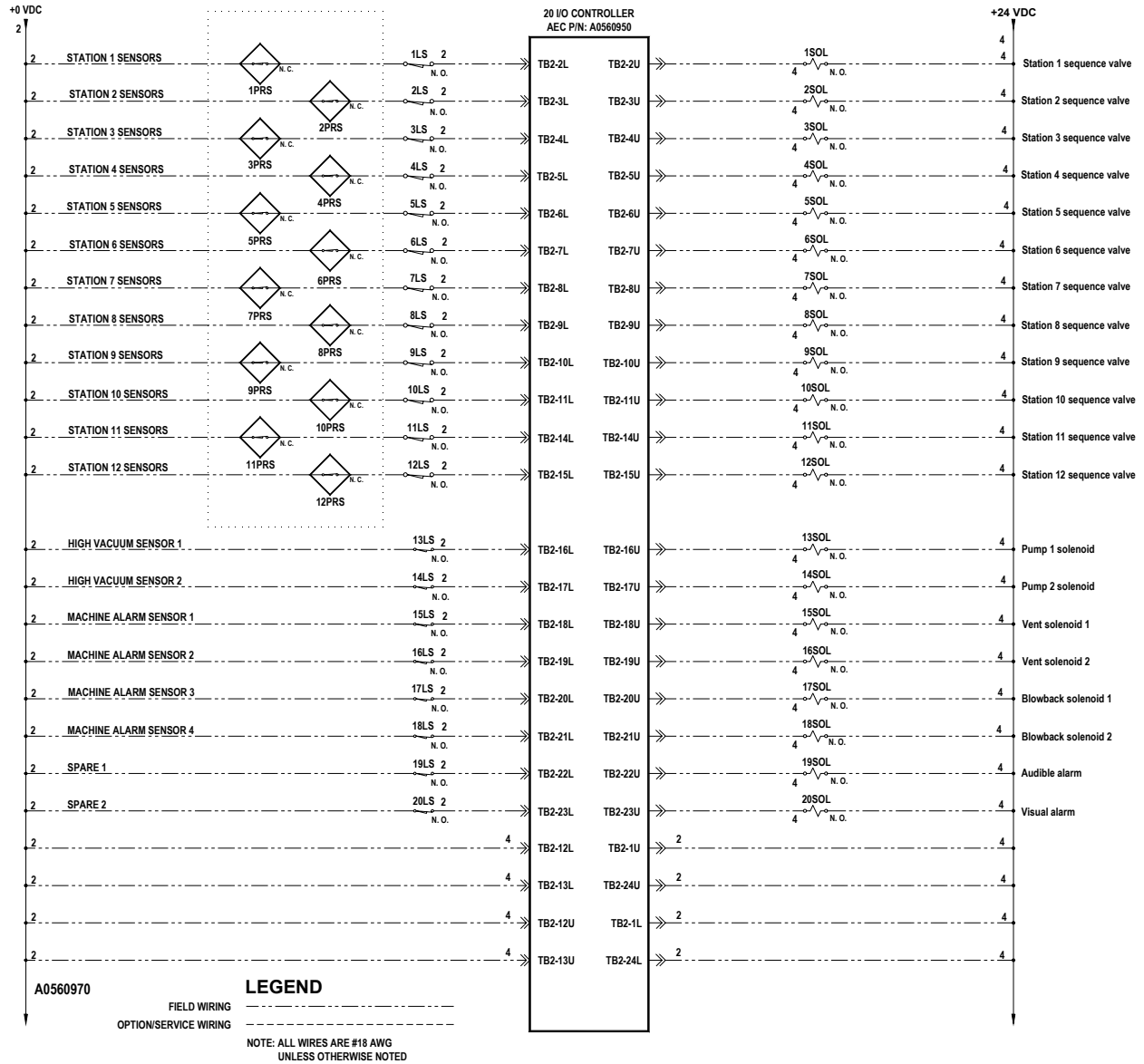

Figure 6: BIOS Connection, Electrical Diagram; Drawing 2



Chapter 6: Troubleshooting

6-1 General Troubleshooting

Problem	Possible cause	Solution
The controller panel doesn't light up at all.	The controller panel is not plugged in.	Plug in the controller panel.
	The external disconnect (recommended) in the dedicated circuit is open (off).	Close the switch (on).
	Fuse/circuit breaker in the power drop is blown/tripped.	Replace/reset.
	Broken controller power switch.	Replace.
A pump package doesn't run, even though it is on line and its indicator is lit.	The motor overload has tripped.	Reset the overload and check the motor for the proper amp draw on tag.
	Main fuse in power drop or optional fused disconnect has blown.	Replace the fuse.
	Motor contact is faulty.	Repair or replace as required.
A vacuum hopper is being bypassed in the loading cycle.	The bin below it is full if its amber indicator light is off.	Normal operation. When the level drops, material conveys to the hopper.
	The hopper is off line.	Using the controller, place the hopper on line.
	The convey time for the hopper is set to zero.	Using the controller, enter a reasonable convey time.
	The field-installed station bypass switch is simulating a Bin Full condition.	Normal operation. Set the switch so the hopper is back in the loading sequence.
	The field-installed station bypass switch is bad or mis-wired.	Repair, replace, or rewire.
Vacuum hoppers are over-filling.	Conveying times are too long (Time Fill mode only).	Time the hopper(s) during loading, and set conveying times to a few seconds less.
	Maximum conveying times are too long and the PCB does not recognize the Hopper Full proximity switch(es).	Check proximity sensors for proper operation and proper wiring to the PCB. Repair as needed. Reset the conveying times to a reasonable value, and adjust as needed.

Problem	Possible cause	Solution
Output icon comes on, solenoid doesn't.	Defective wiring.	Correct/replace wiring.
	Defective terminal block.	Replace defective terminal block.
	Defective PCB.	Replace defective PCB.
	Defective solenoid.	Replace defective solenoid.
Controller blows fuses.	Power supply shorting out.	Repair shorting circuit.
	Excessive loading on solenoids.	Verify proper solenoid use. Call Engineering for assistance.
	Improper fuse installed.	Replace fuse with one that has a proper rating.
Erratic operation.	Excessive static.	Eliminate source of static.
		Ground the controller properly.
	Corrupt RAM data.	Cold-boot the controller. Restore the controller to factory defaults; see Section 8-5 on Page 75 for more information.
		Ground the controller properly.
		I/O logic failing.
False input signal.	Increase input delay time.	
No Convey alarm does not light.	False input signal.	Increase input delay time.

Controller Recovery using Flash Memory Technology

It is possible for a write error to occur while information is being saved in the controller's memory. If this occurs, the system always saves a backup of the data.

To recover from a write failure:

- Shut off the controller, wait 15 seconds, then restart the controller.

The boot sequence detects the write error and attempts to restore the backup file.

It is also possible, although rare, that the backup and original file could both become corrupt. If this occurs, then reset the controller to factory default parameters before proceeding. However, all parameters you've previously stored are lost and you'll need to set up the controller from the beginning. ***You should record what settings you use in the controller system if this occurs.***

The following screens display while the controller writes to flash memory. Again, ***do not cycle power*** while these two screens display.

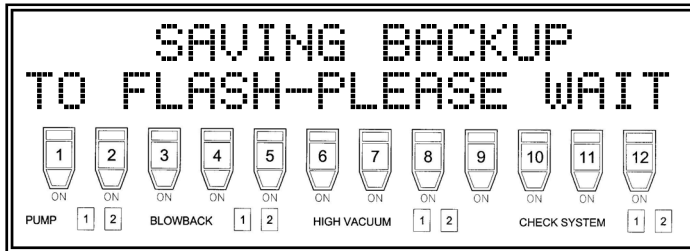
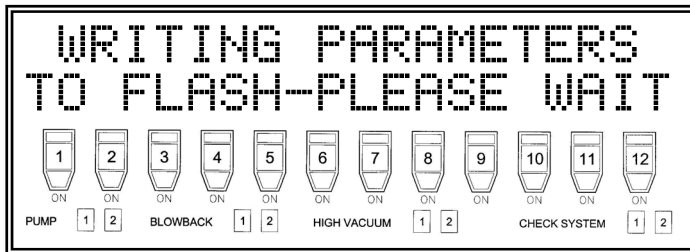

Note: *The controller needs about 30 seconds for saving to flash memory. If the controller doesn't clear this display within 60 seconds, you may need to cycle power. This rare type of problem is caused by a write failure not detected by the controller. This rare condition usually requires a complete factory default reset for full recovery.*

Chapter 7: Appendix

7-1 Warranty

Unless otherwise specified, this product includes a Standard ONE YEAR PARTS AND LABOR WARRANTY.

Warranty Specifications

The manufacturer hereby expressly warrants all equipment manufactured by it to be free from defects in workmanship and material when used under recommended conditions, as set forth in the operating manuals for such equipment. THE FOREGOING EXPRESS WARRANTY IS EXCLUSIVE AND IN LIEU OF ALL OTHER WARRANTIES, GUARANTEES, AGREEMENTS, AND SIMILAR OBLIGATIONS OF THE COMPANY AND/OR MANUFACTURER (UNLESS OTHERWISE SPECIFIED IN THE SPECIFIC PRICE PAGE OR LIMITED BY THE MANUFACTURERS' WARRANTY FOR PARTS). The Company's obligation is limited to repair or replace FOB the factory any parts that are returned, prepaid, within one year of equipment shipment to the original purchaser, and which in the Company's opinion, are defective. Any replacement part assumes the unused portion of this warranty.

Warranty Restrictions

This parts warranty does not cover any labor charges for replacement of parts, adjustment repairs, or any other work. This warranty does not apply to any equipment which, in the Company's opinion, has been subjected to misuse, negligence, or operation in excess of recommended limits, including freezing or which has been repaired or altered without the Company's express authorization. If the serial number has been defaced or removed from the component, the warranty on that component is void. Defective parts become the property of the warrantor and are to be returned immediately, without any further use or handling.

Warranty Liabilities

THE COMPANY EXPRESSLY DISCLAIMS ANY AND ALL LIABILITY FOR ANY SPECIAL, CONSEQUENTIAL OR INCIDENTAL DAMAGES OR EXPENSES THAT RESULT FROM THE USE OF THIS PRODUCT. Some states do not allow the exclusion or limitation of special, consequential or incidental damages, so the above limitation may not apply to you. The Company's obligation for parts not furnished as components of its manufactured equipment is limited to the warranty of the manufacturers of said parts. The company neither assumes nor authorizes any other persons to assume for it any liability in connection with the sale of its equipment not expressed in this warranty. No person, agent, manufacturer, distributor, dealer, installer or company is authorized to change, modify or extend the terms of this warranty in any manner whatsoever.

The time within which an action must be commenced to enforce any obligation of the Company's arising under this warranty, or under any statute or law of the United States or any state thereof, is hereby limited to the duration of this warranty. Some states do not permit this limitation, so the above may not apply to you. This warranty gives you specific legal rights and you may also have other rights which vary from state to state. For transactions involving the potential applicability of international law or that of a foreign country, this warranty policy and the procedures hereunder shall be governed by applicable federal and state law, but not by the United Nations Convention on Contracts for the Sale of Goods.

Customer Responsibilities

Any sales, use, or other tax incident to the replacement of parts under this warranty is the responsibility of the purchaser.

7-2 Drawings and Diagrams

Figure 7: 2 pump 12 station Controller Control Panel

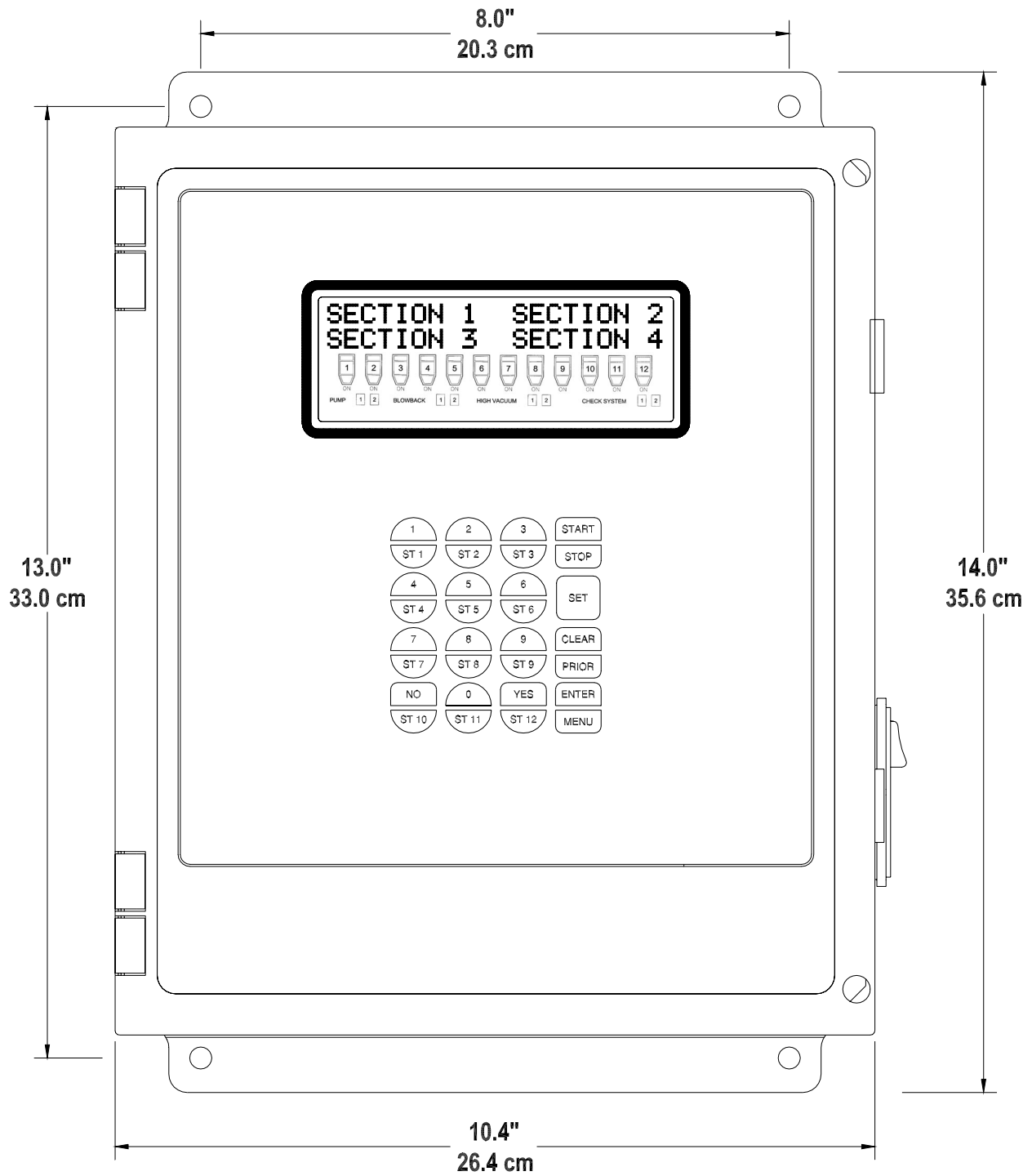

Depth dimension of subpanel: 8.0" D (20.3 cm).

Also, review electrical drawings supplied in the packet with this manual.

7-3 Spare Parts List

Figure 8: Typical 12-Station Controller Exterior Components, Exploded View

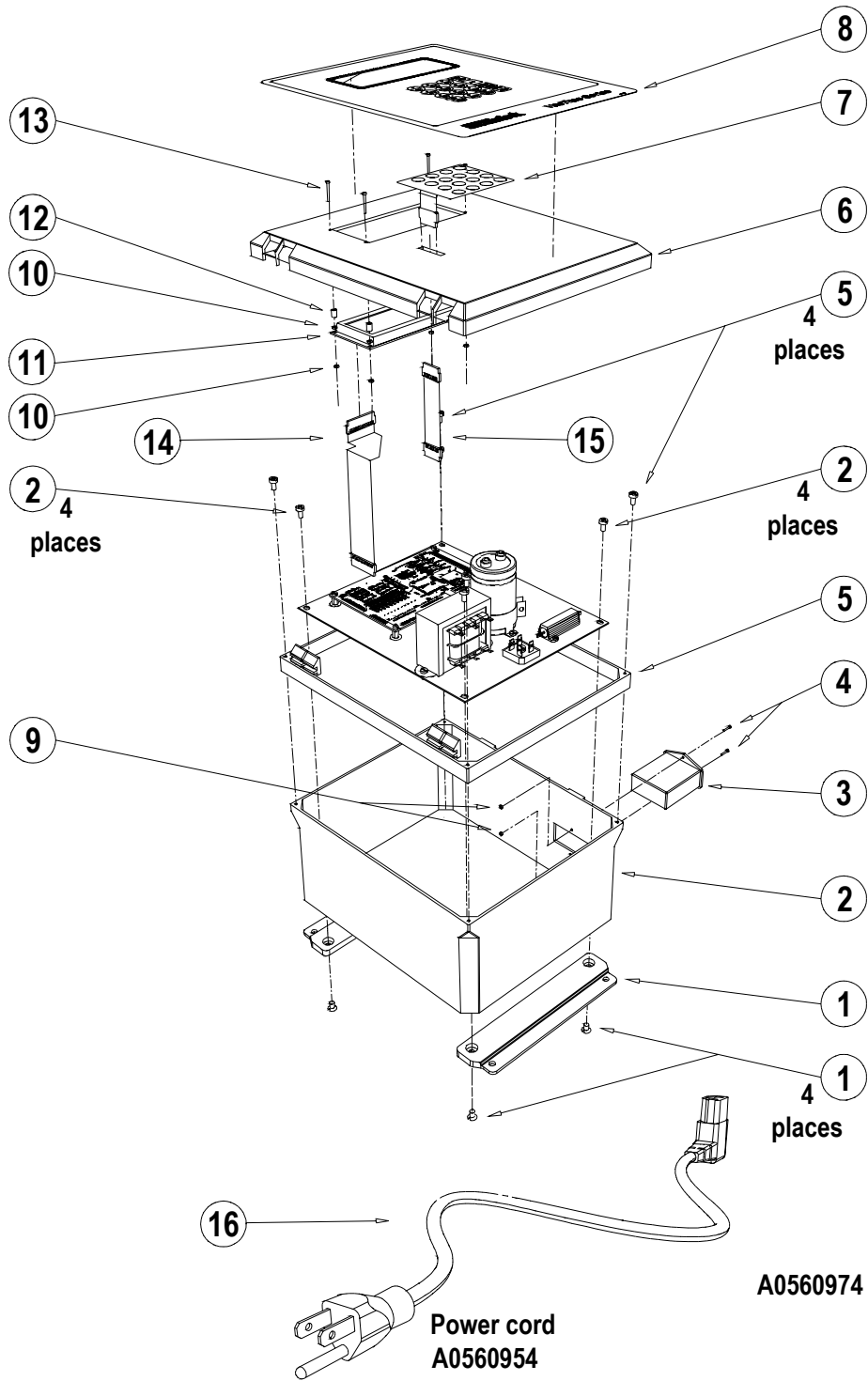

Figure 9: Exterior Components Parts List

Refer to Figure 8 on Page 51 when identifying parts.

Item	Qty.	Part no.	Description
1.	1	A0560963	ENCL, CARLON, MOUNT FLNG, MNK10L
2.	1	A0560964	ENCL, CARLON, 12 X 10 BODY, NP1210B
3.	1	A0560955	SW, PWR, SHAFNR W/FLTR & FUSE
4.	2	W00015317	SCR, RHM, 4-40 X 5/8
5.	1	A0560962	ENCL, CARLON, COLLAR, NH1210C
6.	1	A0560965	ENCL, CARLON, 12 X 10 LID, NH1210L
7.	1	A0803341	KYP, LONG TACTILE
8.	1	A0560501	GRPH, 12 STATION, VAC-TRAC
9.	2	W00000960	NUT, HEX HD, PLT, 4-40
10.	4	A0560968	NUT, HEX HD, PLT, 2-56
11.	1	A0559156	DSPLY, LCD, CRYSTALOID, CRUSM1056
12.	1	A0560969	SPCR, NYLON, 0.091 ID, 0.185 OD, 1/8"
13.	1	A0560967	SCR, PAN HD, SLTD, PLT, 2-56 X 3/4"

Figure 10: Typical 12-Station Controller Interior Components, Exploded View

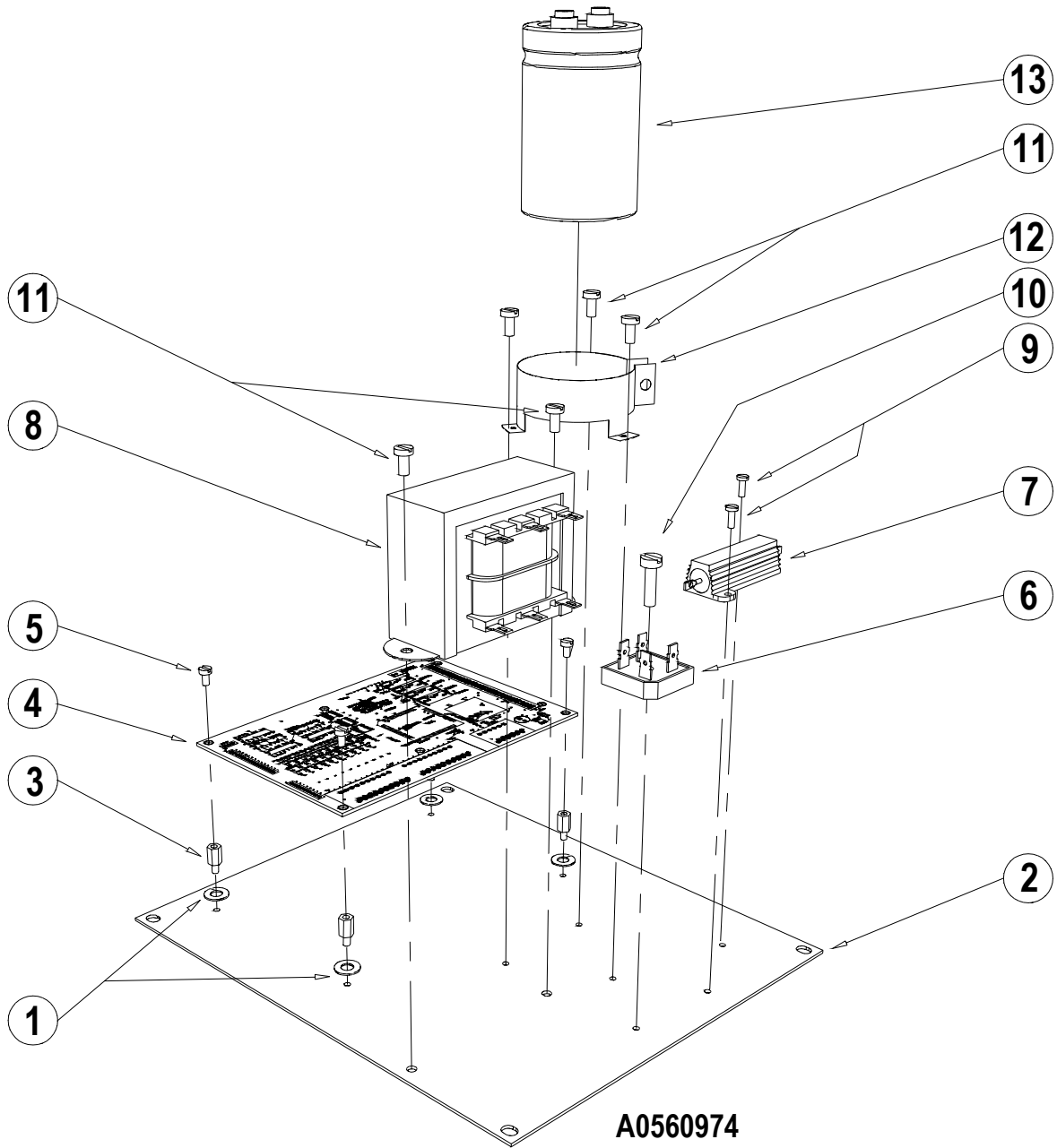

Figure 11: Interior Components Parts List

Refer to Figure 10 on Page 53 when identifying parts.

Item	Qty.	Part no.	Description
1.	4	W00001055	WASH, #6 SAE FLAT, PLD
2.	1	A0560961	PNL, SUB, CARLON, JP1210, 10 X 8
3.	4	A0530780	STND, OFF (M/F) #6-32 X 0.5" LG. HE
4.	1	A0560958	PCB, DNTL, 201/O, 128 K RAM/ROM
5.	4	A0101507	SCR, RHM, PLD, 6-32 X 1/4
6.	1	A0539383	RECT, BRIDGE, 25 AMPS, GBPC2510
7.	1	A0560956	ELEK, RES, 50 OHM, 50 WATT, CLEROSTAT
8.	1	A0539387	XFMR, 16 VCT, 112 VA, MCI 4-07-8016
9.	2	W00015057	SCR, PAN HD, SLTD, PLT, 4-40 X
10.	1	A0069176	SCR, RHM, PLD, 10-32 X 3/4
11.	5	A0102356	SCR, RHM, PLD, 8 X 32 X 3/8
12.	1	A0539389	CAP, BRKT, MT, VRIO, MALLORY
13.	1	A0539382	CAP, ELEC, 22000UFD, 30 VDC, ALUCAN

7-4 Controller Identification (Serial Number) Tag

(Located on the side of the controller box)

Street Address		
Town, State, Zip Code		
Telephone Number		
Fax Number		
<hr/>		
XXX CONTROL PANEL		
Model No. XXX2-12		Serial No. 31K0182
230	Volt	60
		Hz
		1
		Ph
Control Voltage 24VDC		
<div style="border: 1px solid black; height: 40px; width: 100%;"></div>		

7-5 Technical Assistance (Contact Information)

Parts Department

Call toll-free 7am–5pm CST [800] 423-3183 or call [630] 595-1060, Fax [630] 475-7005

The ACS Customer Service Group will provide your company with genuine OEM quality parts manufactured to engineering design specifications, which will maximize your equipment's performance and efficiency. To assist in expediting your phone or fax order, please have the model and serial number of your unit when you contact us. A customer replacement parts list is included in this manual for your convenience. ACS welcomes inquiries on all your parts needs and is dedicated to providing excellent customer service.

Service Department

Call toll-free 8am–5pm CST [800] 233-4819 or call [630] 595-1060

Emergencies after 5pm CST, call [847] 439-5655

We have a qualified service department ready to help. Service contracts are available for most products.

Sales Department

Call [630] 595-1060 Monday–Friday, 8am–5pm CST

Our products are sold by a world-wide network of independent sales representatives. Contact our Sales Department for the name of the sales representative nearest you.

Contract Department

Call [630] 595-1060 Monday–Friday, 8am–5pm CST

Let us install your system. The Contract Department offers any or all of these services: project planning; system packages including drawings; equipment, labor, and construction materials; and union or non-union installations.

Chapter 8: Service Only Information

Note: Hidden, programmable features and hidden menu pages should not be made available to floor operators. These pages include the Service Information located in this section. Unauthorized changes to these factory settings by inexperienced operators may prevent the controller from operating properly, and may void part or all of the warranty.

Note: If this manual is to be used on the floor by the operator, keep this section separate from the rest.

8-1 Service Settings Menu

Setting the Ramp Up Time

Ramp up time is a delay that allows the pump to establish full speed before the valve opens. This delay **defaults to 1.5 seconds** and **should not be altered** unless instructed to do so by the Service Department.

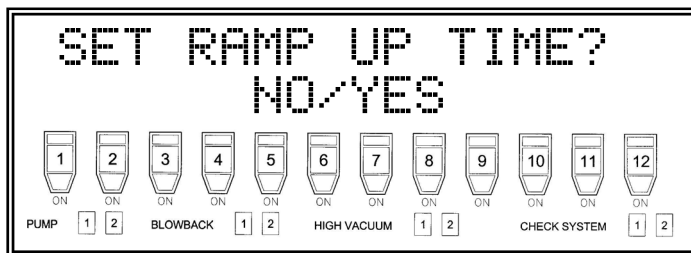

At the above message prompt:

- Press the YES key to enter the Ramp Up Time menu.

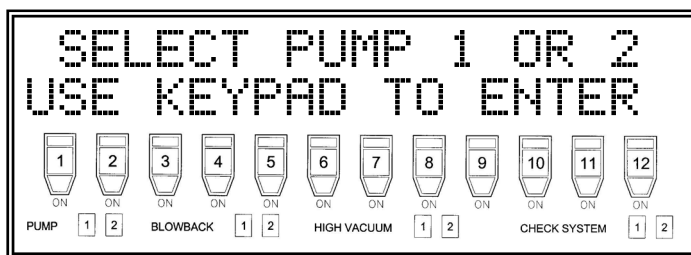

Select the pump for altering ramp up time.

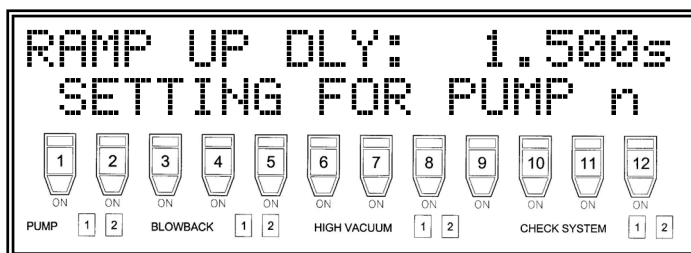

Using the keypad:

- Enter the new time and press the ENTER key to save the new setting.

Setting the Ramp Down Time

Ramp down time is a delay that allows the pump to come to a full stop when needed. The control cannot restart until this delay is completed. This is also known as the *Shutdown* delay. This delay **defaults to 8.0 seconds** and **should not be altered** unless instructed to do so by the Service Department.

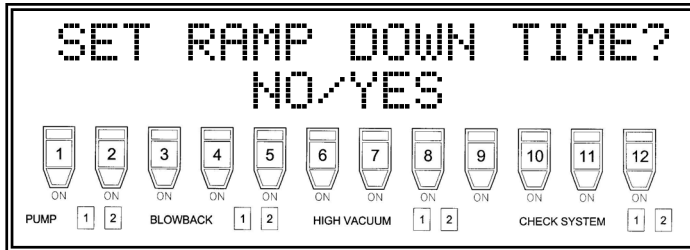

At the above message prompt:

1. Press the YES key to enter the Ramp Down Time menu.
2. Select the pump for altering ramp down time.

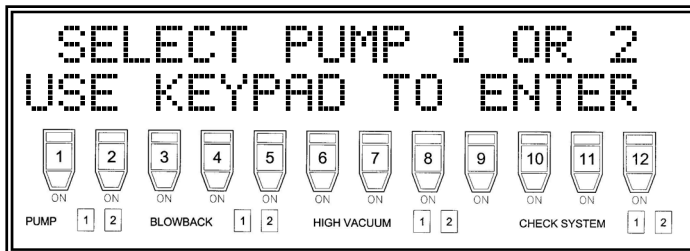

The following screen displays.

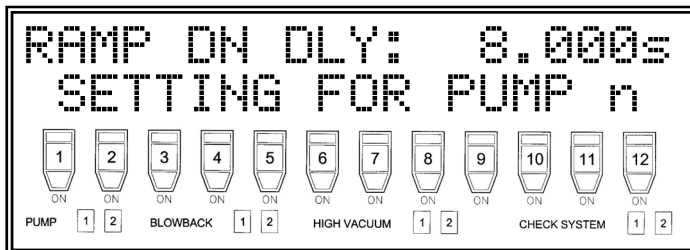

Using the keypad:

3. Enter the new time and press the ENTER key to save the new setting.

Setting the Pump Stage Time

Pump stage time is a delay that prevents both pumps from engaging at the same time. Although rare in a two-pump system, both pumps can sometimes start at the same time. This condition causes an excess of current on the electrical system from such a surge.

The pump stage time delay **defaults to 3.0 seconds** and **should not be altered** unless you are instructed to do so by the Service Dept.

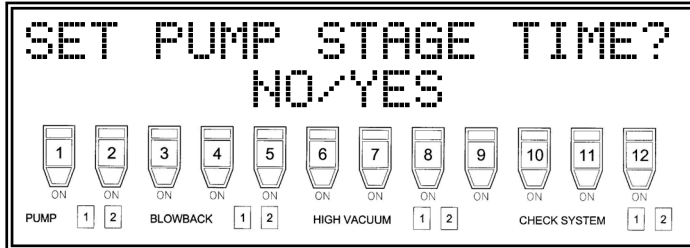

At the above message prompt:

1. Press the YES key to enter the Pump Stage Time menu.

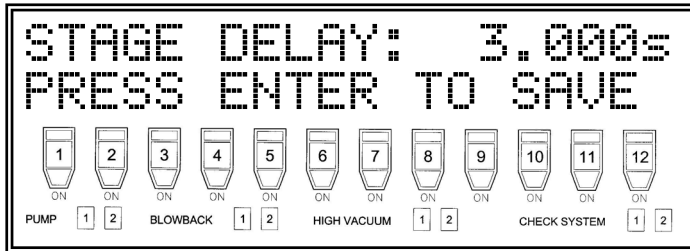

Using the keypad:

2. Enter the new time and press the ENTER key to save the new setting.

Setting the LCD Blink Delay

LCD Blink Delay lets you alter the **ON/OFF** time that the LCD blinks during an alarm. This delay does not effect the Visual or Audible alarm outputs. The delay **defaults to 0.5 seconds** and **should not be altered** unless you are instructed to do so by the Service Department.

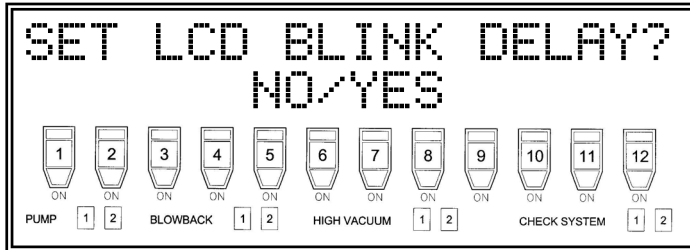

At the above message prompt:

1. Press the YES key to enter the LCD Blink Delay menu.

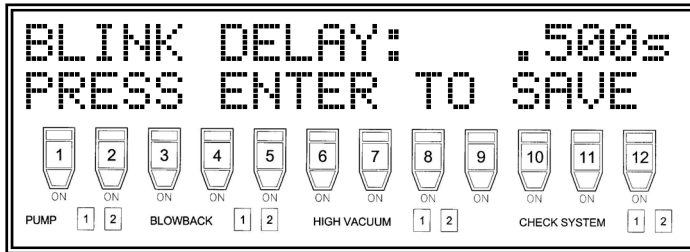

Using the keypad:

2. Enter the new time and press the ENTER key to save the new settings.

Setting the Hi Vacuum Sensor Delay

Hi vac sensor delay is the time that a high vacuum condition must exist before it is sensed by the controller. This delay eliminates the annoying Hi Vacuum errors which self-clear or are erroneous. This delay **defaults to 3.0 seconds** and **should not be altered** unless you are instructed to do so by the Service Department.

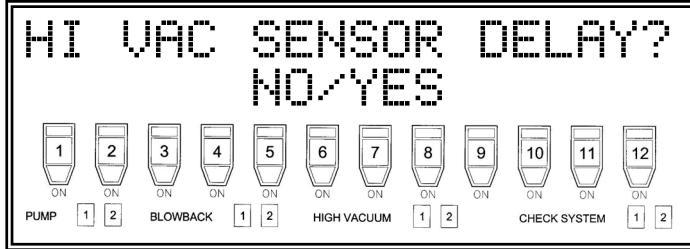

At the above message prompt:

1. Press the YES key to enter the Hi Vacuum Sensor Delay Time menu.

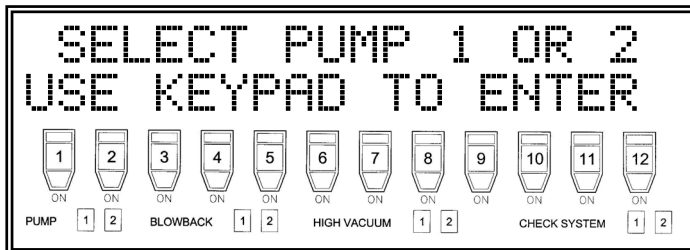

At the above message prompt:

2. Select the pump for altering vacuum sensor delay.

The following screen displays:

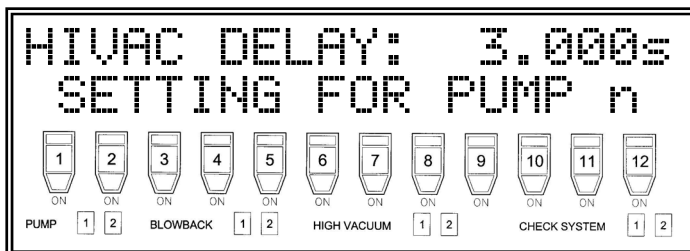

Using the keypad:

3. Enter the new time and press the ENTER key to save the new setting.

Setting the Hi Vacuum Vent Delay

Hi vacuum vent delay is the vent time initiated by a high vacuum condition. This delay defaults to 10.0 seconds and should not be altered unless you are instructed to do so by the Service Department.

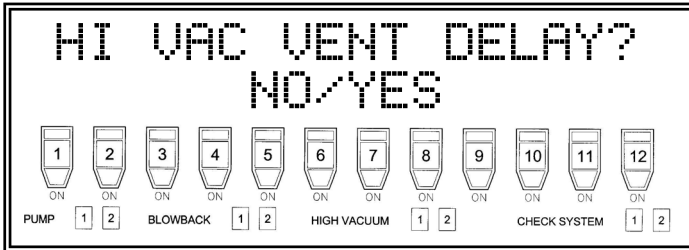

At the above message prompt:

1. Press the YES key to enter the Hi Vacuum Vent Delay Time menu.

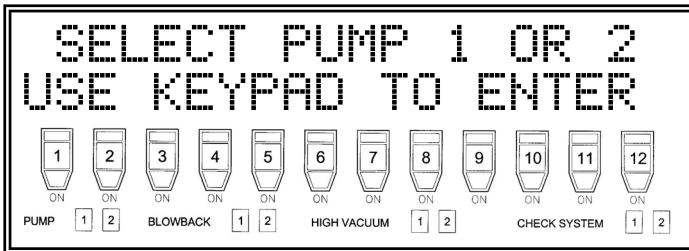

At the above screen prompt:

2. Select the pump for altering vacuum vent delay.

The following screen displays.

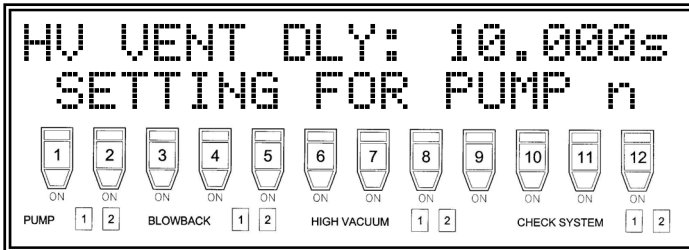

Using the keypad:

3. Enter the new time and press the ENTER key to save the new setting.

Setting the Hi Vacuum Load Count

Hi vacuum load count sets the maximum number of loads on a station in a high vacuum condition. If a station repeatedly experiences a high vacuum condition for the selected number of loads without being cleared or attended to, it goes **off line** to prevent damage to the conveying system. This parameter **defaults to 7 loads** and **should not be altered** unless you are instructed to do so by the Service Department.

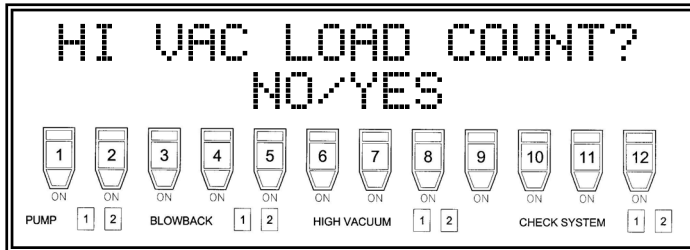

At the above message prompt:

1. Press the YES key to enter the Hi Vacuum Load Count menu.

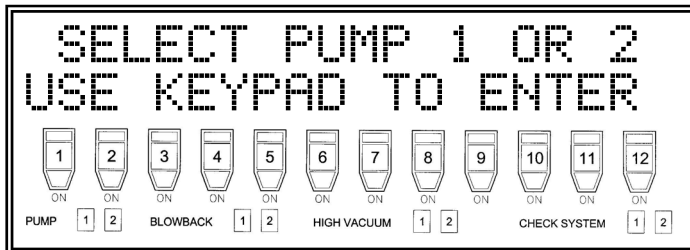

At the above screen prompt:

2. Select the pump for altering the high vacuum load count.

The following screen displays.

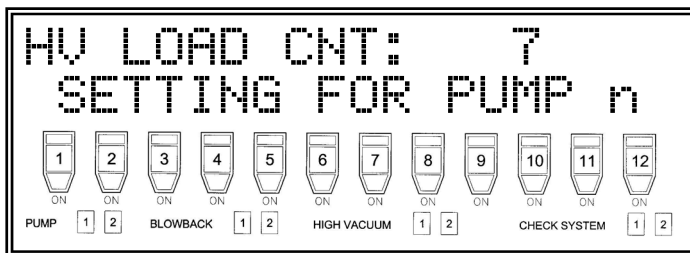

Using the keypad:

3. Enter the new time and press the ENTER key to save the new setting.

Using the Installation Aids Menus

Input Monitor Screen

To assist in the installation process or to aid in problem diagnoses, the controller uses two (2) OEM menu functions. The Input Monitor screen displays all 20 inputs in **real time**. 0 represents no input and 1 indicates an active input.

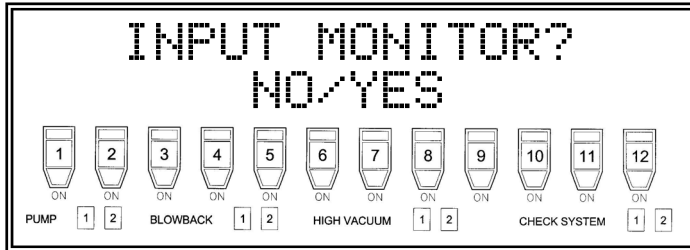

At the above message prompt:

1. Press the YES key to enter the Input Monitor menu.

You now have access to the OEM menu system and Input Monitor menu.

The following screen displays:

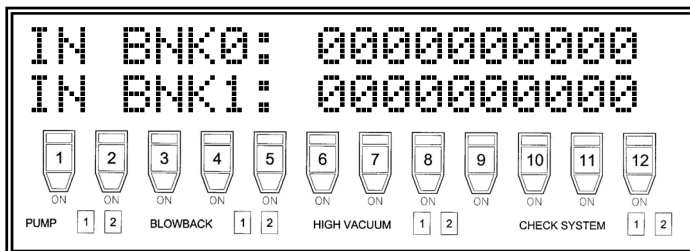

The top row (Bank 0 [IN BNK0]) shows the input status of the first ten (10) inputs. The bottom row shows the status of inputs 11-20 (Bank 1 [IN BNK0]).

To exit this menu:

2. Press the CLEAR key.

Output Control Menu

The Output Control menu gives you direct access to all 20 outputs of the controller. The menu has two (2) modes: Manual and Automatic. Automatic mode cycles each output on and off. Manual mode gives you access to each individual output.

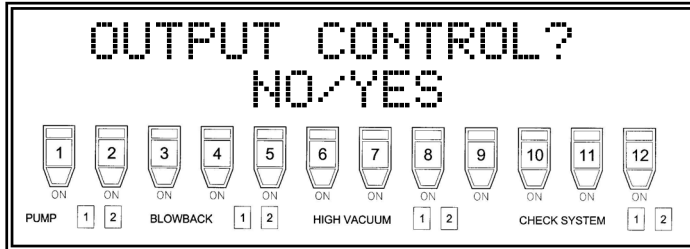

At the above message prompt:

1. Press the YES key to enter the Output Control menu.

The following screen displays.

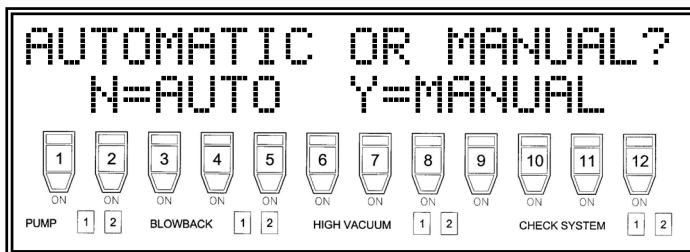

To start the automatic cycle:

- Press the NO key.

To increase speed:

- Press the START/STOP key.

To *decrease* speed:

- Press the SET key.

To exit the Output Control menu and turn all outputs OFF:

2. Press the CLEAR key.

Caution! *Automatically cycling outputs with the pump in Active mode can damage the conveying system.*

Caution! *Do not perform this action unless directed to do so by the Service Department.*

To access the outputs manually, at the AUTOMATIC OR MANUAL? screen prompt:

1. Press the YES key.

The following screen displays.

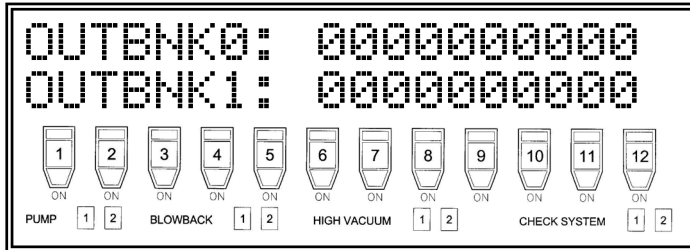

A cursor displays on the screen.

To move the cursor left:

- Press the 4 key.

To move the cursor right:

- Press the 6 key.

To move the cursor up:

- Press the 2 key.

To move the cursor down:

- Press the 8 key.

To toggle output ON or OFF:

- Press the START/STOP key.

To exit this menu:

2. Press the CLEAR key.

Caution! *Enabling the Pump output without opening any sequence valves can cause damage to the conveying system.*

Caution! *Do not perform this action unless directed to do so by the Service Department.*

8-2 Other Controller Restricted Areas

Using the OEM Service Menu

The *OEM service menu* (Original Equipment Manufacturer) lets you set parameters not commonly used. It also contains functions to aid in the installation of the controller. **Access to this menu should be restricted to setup and maintenance personnel only.**

To gain access to the OEM service menu:

1. Remove power from the controller.
2. Press and hold the Zero **0** key and re-apply power. While holding the Zero **0** key, allow the controller to initialize.

The controller displays the message below and permits access to the OEM service menu.

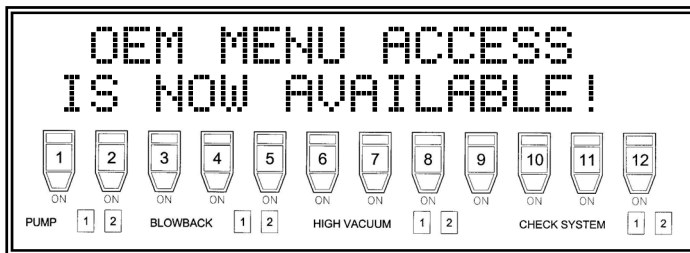

Gain access to the OEM service menu by entering the menu system. An additional menu screen is shown below.

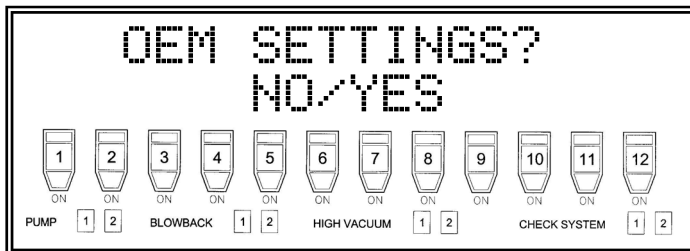

Recovering Passwords

By following this procedure, passwords can be displayed should they be lost or forgotten.

Note: *In the interest of system security and integrity, make sure that only setup people and supervisors know this procedure.*

Follow these steps to recover passwords.

1. Remove power from the controller.
2. Press and hold the 3 key.
3. Reapply power as you continue to hold down the 3 key.
4. The screen displays up to four (4) password settings during controller initialization. Note the sample screen below.
5. Press the CLEAR key to continue with initialization.

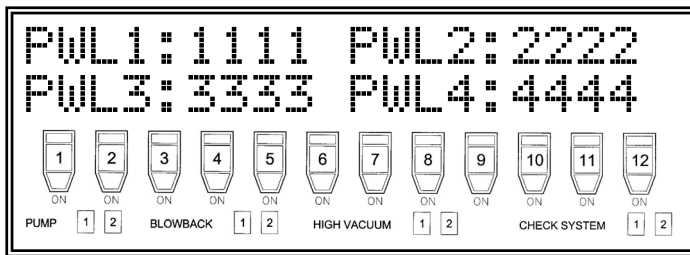

Note: *Passwords shown on this screen are illustration only.*

Restoring the Controller to Factory Defaults

Although rare, you may experience a condition when you need to perform a total reset of the controller. To do so, perform the following procedure.

Note: All parameters you set are lost **when doing this procedure, including passwords and OEM Service settings.**

Follow these steps to restore the controller to factory defaults.

1. Remove power from the controller.
2. Press and hold the CLEAR key.
3. Re-apply power while holding down the CLEAR key.

During initialization, the screen displays a message indicating that factory default settings are set.

Verifying Software Checksums

Follow these steps to verify software checksum values.

1. Remove power from the controller.
2. Press and hold the SET key.
3. Re-apply power while holding down the SET key.

During initialization, the screen displays a message while the controller calculates the software check sum. This number is in hexadecimal format (Base 16) and displays in numbers and letters.

Example: 0x1FC9 is a valid checksum format.

