

ROSEN®



a new generation of leadership in mobile video

AC 3105 External TV Tuner

Owner's Manual and Installation Guide

Contents

| | |
|--|----------|
| Notices | 3 |
| Introduction and Specifications | 4 |
| Using the AC3105 | 5 |
| The Remote Control | 6 |
| Installation | 7 |
| Wiring | 8 |

NOTICE OF INTENDED USE

ROSEN ENTERTAINMENT SYSTEMS ARE DESIGNED TO ENABLE VIEWING OF VIDEO RECORDINGS ONLY FOR REAR-SEAT OCCUPANTS.

MOBILE VIDEO PRODUCTS ARE NOT INTENDED FOR VIEWING BY THE DRIVER WHILE THE VEHICLE IS IN MOTION. SUCH USE MAY DISTRACT THE DRIVER OR INTERFERE WITH THE DRIVER'S SAFE OPERATION OF THE VEHICLE, AND THUS RESULT IN SERIOUS INJURY OR DEATH. SUCH USE MAY ALSO VIOLATE STATE LAW.

ROSEN ENTERTAINMENT SYSTEMS DISCLAIMS ANY LIABILITY FOR ANY BODILY INJURY OR PROPERTY DAMAGE THAT MAY RESULT FROM ANY IMPROPER OR UNINTENDED USE.

This device complies with Part 15 of FCC rules. Operation is subject to the following two conditions:

- 1) This device may not cause harmful interference.
- 2) This device must accept any interference received, including interference that may cause undesired operation.

Introduction

The AC3105 is a TV Tuner for automotive entertainment systems. It requires a TV antenna suitable for automotive use (not included, available from your Rosen dealer). It can be connected to systems that use RCA audio and composite video connectors, and is capable of integrating into some Rosen systems (such as the Rosen A7) using an optional harness. *Please remember that the quality of mobile TV reception varies with location, terrain, signal strength, and other environmental variable conditions.*

NOTE: This unit is meant to be part of a complete audio/video system. Some essential system components, such as a TV antenna and RCA interconnect cables, are not included - this allows you to select the most appropriate components for your system. If you need assistance in selecting the proper components, or in performing your installation, please contact your Rosen authorized dealer.

AC3105 Unit

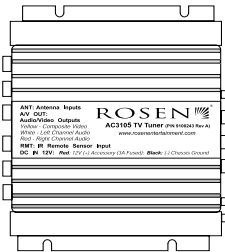

Remote Control

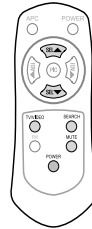

IR Receiver



AC3105 TV Tuner Specifications

Tuner type: NTSC Video receiver, VHF L (channels 2-6), VHF H (channels 7-13), and UHF (channels 14-69).

Power supply: Nominal 12V DC negative ground (11-14V DC compatible).

Maximum current consumption: 1A @ 12V DC.

Audio input sensitivity: 0.5V RMS.

Video Input and output (75 Ohm composite): 1.0V peak-to-peak.

Dimensions: 134mm x 118mm x 34mm.

Operating temperature: 0° to 50° Celsius.

Using the AC3105

The AC3105 operates only when the ignition key switch is in the Run or Accessory positions.

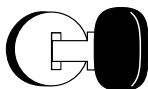

ACC or engine
ON position

Operation of the tuner is performed with the remote control (see opposite page). When used with the Rosen A7, please see the A7 Owner's manual for additional user instructions.

Aim the remote at the IR receiver. Press the **[POWER]** button *at the bottom of the remote* to turn the tuner on and off (note that the "power" button at the top of the remote does not operate the unit). When the tuner initially turns on, an on-screen display will appear on the monitor(s), indicating which input is active and, if in tuner mode, which channel is selected.

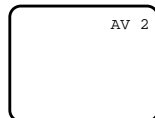
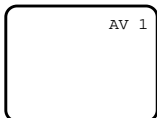
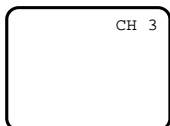

To switch to the auxiliary A/V inputs (used with optional equipment such as video games), press the **[TV/VIDEO]** button.

NOTE: The A/V inputs do not operate when connected to the Rosen A7 system using the optional harness.

To find what TV channels can be received in your area, press the **[SEARCH]** button. The "AUTO MEMORY" screen appears. Use the Search feature to find local channels whenever in new areas.

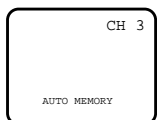

To mute the audio, press the **[MUTE]** button. Press again to restore audio. While muted, this screen will appear:

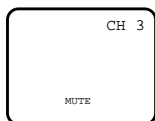

The Remote Control

Before use, slide the battery cover off of the bottom of the remote control and insert two AAA batteries (included) as indicated within the battery compartment. If storing the remote for long periods, place it in a cool dry location, and remove the batteries.

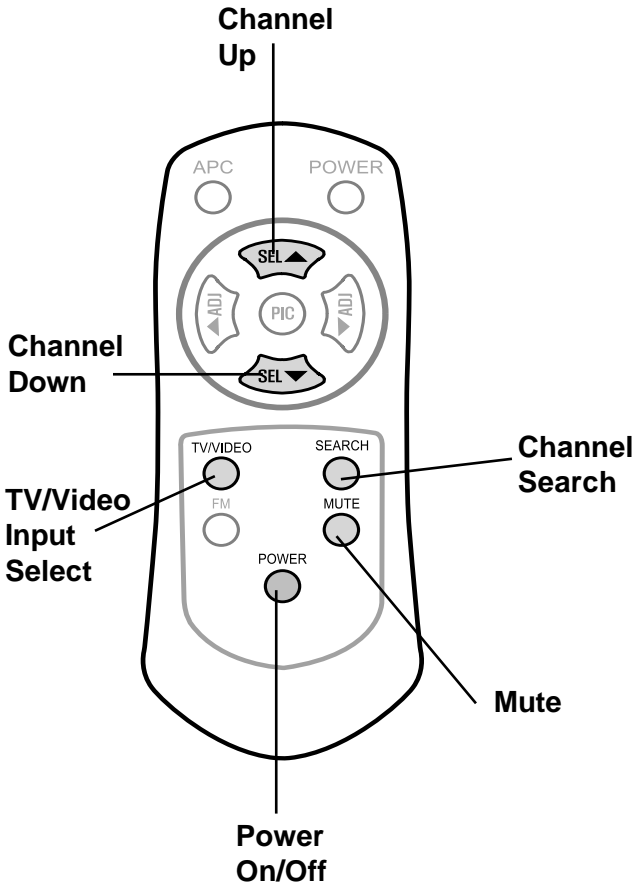

NOTE: Some buttons on the AC3105 remote control do not operate with the AC3105 - they are for other applications using optional equipment. All operating buttons are highlighted in the diagram above.

Installation and Wiring

1. Before Starting

Read these instructions and the precautions carefully.

WARNING!

Be sure to disconnect the battery (-) terminal before starting. This is to prevent short circuits during installation.

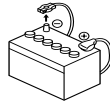

Precautions

- This unit is only for cars with negative-ground, 12V electrical systems.
- Do not open the case. There are no user-serviceable parts inside.

2. Package Contents

AC3105 Unit
Remote Control and batteries
IR Receiver and cable
Owner's Manual / Installation Guide

NOTE: No TV antenna is included. Rosen offers compatible antennas for automotive use -see your Rosen dealer for more information.

3. Installing the AC3105

Mount the unit in a dry, flat location. If using mounting screws, verify that the screws will not damage the vehicle wire harnesses and/or fuel lines. Ensure that the unit is firmly mounted and cannot come loose in the event of a collision. Also ensure that there is sufficient clearance around the unit to avoid any pinching of the cables.

4. The AC3105 Unit:

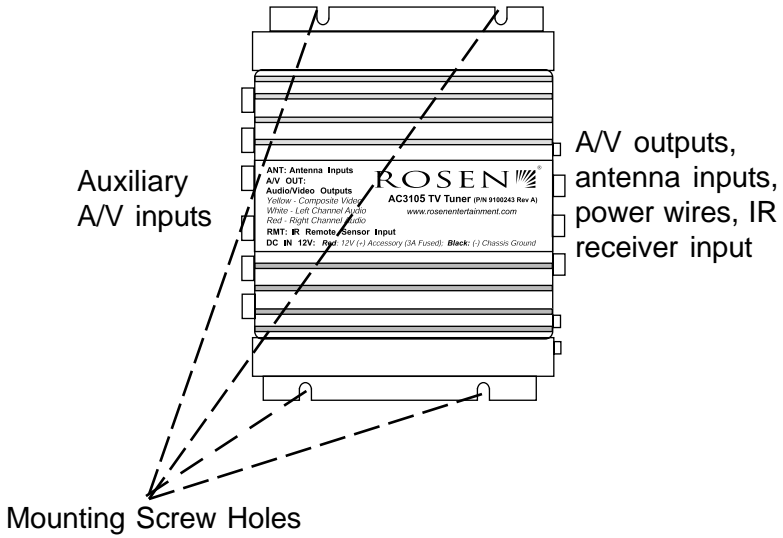

AC3105 Connectors:

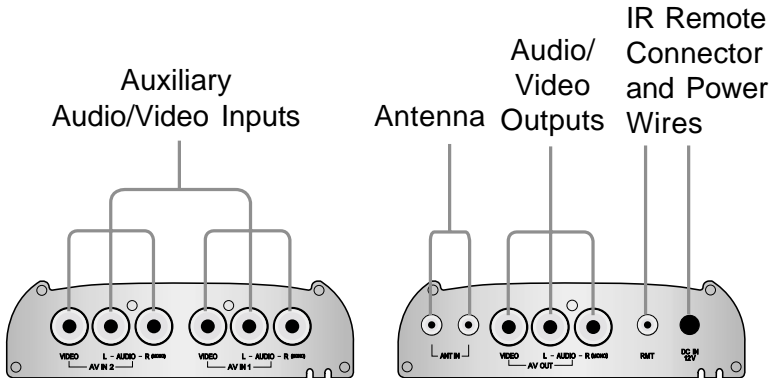

5. Wiring

Wiring the AC3105 varies with the installation. The AC3105 can be used in two configurations:

As an auxiliary source for a monitor or system, using the supplied remote control and IR receiver to control the tuner. In this type of installation, place the IR receiver where the user can see it, so that the remote can operate properly.

As an external TV tuner for the Rosen A7 system, using the optional TV Tuner harness (RES PN 9100233). When this harness is used, the tuner is controlled by the A7 remote and front-panel controls, and the IR receiver is not required.

NOTE: When used with the A7, the AC3105 auxiliary inputs are not supported.

Read the following precautions before wiring any system.

- ***Do not connect the red wire to constant 12V(+)***! This will cause battery drain. Ensure that the red wire is connected to a switched, “accessory” circuit in the car!
- Rosen recommends connecting all ground wires for all video components in a system to a single point.
- Be particularly careful where you route wires and cables. Keep them away from the engine, exhaust system, etc.
- If a fuse should blow, make sure all connections are correct and no wires are damaged before replacing the fuse. Use a 3A fuse on the power wire.

NOTE: If the screen displays red and black horizontal bars when the tuner mode is selected, this means that the TV antenna is not connected or is malfunctioning.

NOTE: Since each vehicle is different, you may need to experiment with antenna placement. If you experience poor reception, test the unit's reception using only one of the two antenna connections.

Connecting the AC3105 to an audio/video system:

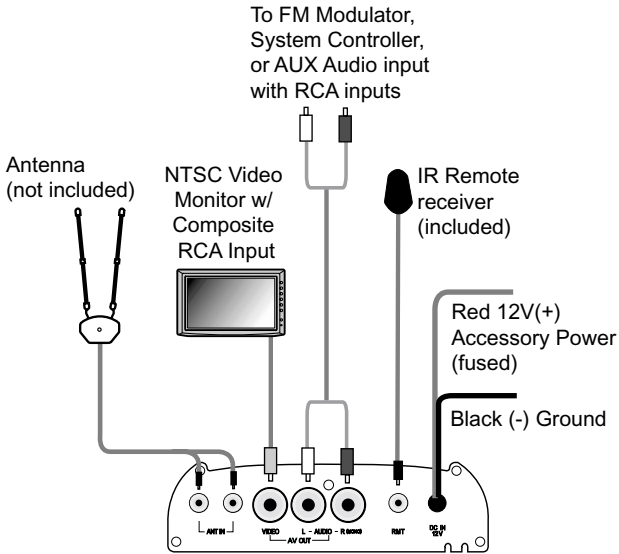

Connecting the AC3105 to a Rosen A7 system:

NOTE: Optional Rosen A7 TV Tuner harness required, RES PN 9100233

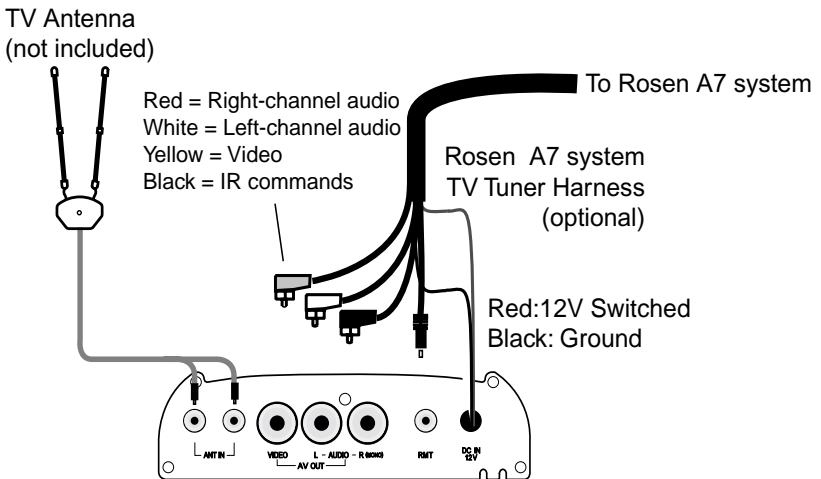

*Please read this entire document carefully
before operating or installing this unit.*



www.rosenentertainment.com
866-GO ROSEN

RES PN 9100243-4