

## Installation Quick Start Guide for RMX 4000

### Basic Setup

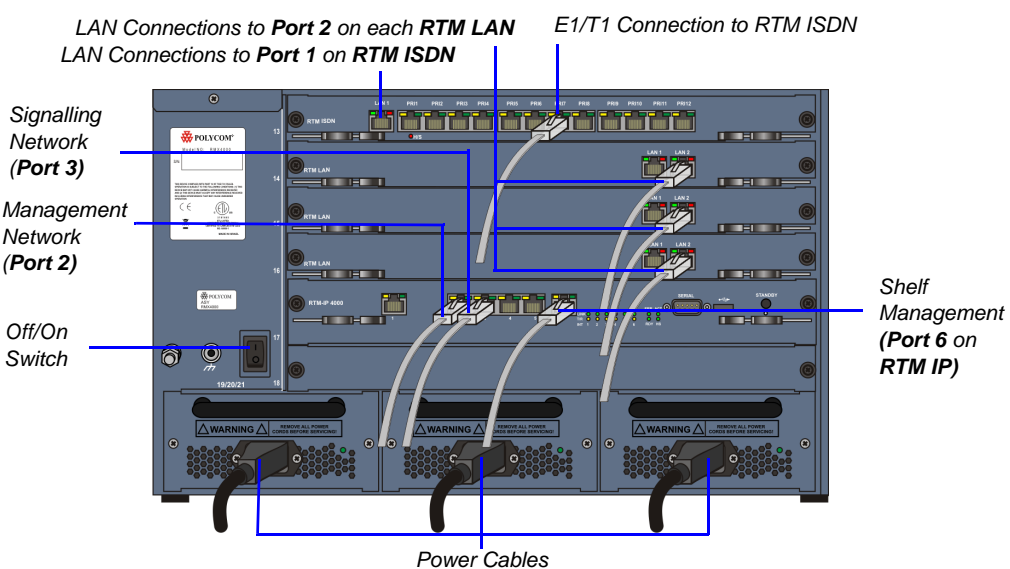

Before installing the RMX 4000 and performing the Basic Setup, please read the General Safety Precautions described in the *Polycom RMX 4000 Hardware Guide*. For a detailed description of Unpacking and Rack mounting instructions, and connecting a DC system, see the *Polycom RMX 4000 Hardware Guide*.

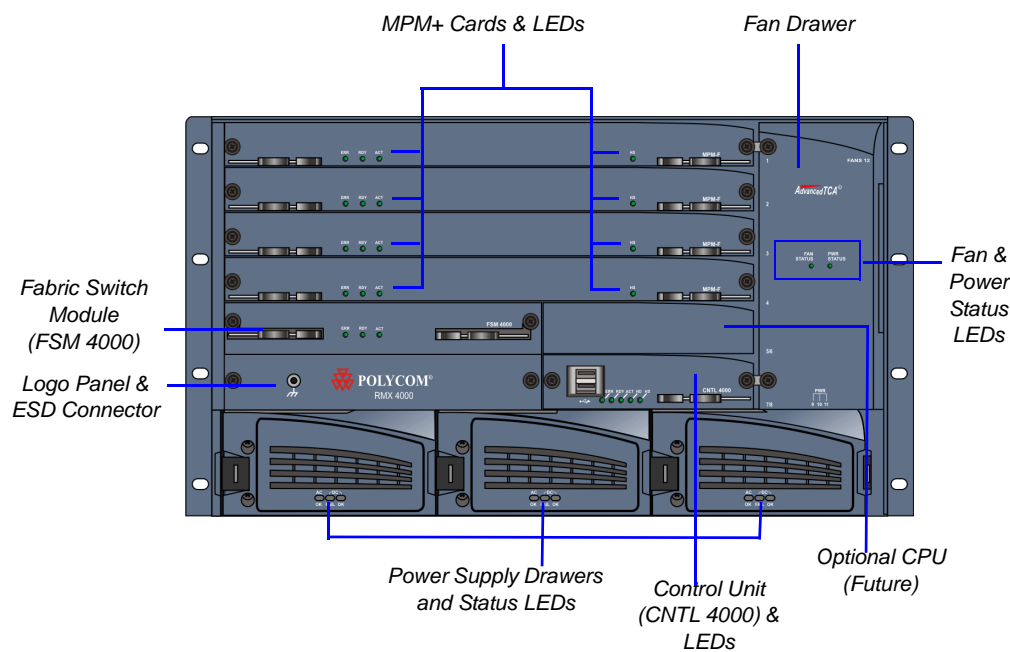

- Two people are required to lift the MCU out of the box and when installing it in a rack.
- LAN 4, LAN 5 and the Serial ports are only for debugging and not for customer use.
- Do not remove the protective plastic caps from LAN 1, LAN 4 and LAN 5 ports.

### Modifying the USB Key Settings

- 1 Insert the *USB key* provided with your system into the PC workstation and double-click **LanConfigUtility.exe** to start the utility.

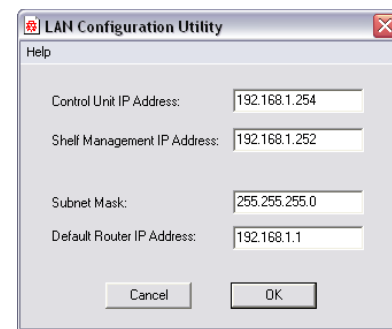

- 2 Modify the parameters in the utility's dialog box using the information supplied by your network administrator.
- 3 Click **OK**.
- 4 Remove it from the PC.

### First-time Power-up and Connection to MCU

- 1 Insert the *USB key* containing the modified IP addresses in the USB port on the RMX's back panel.

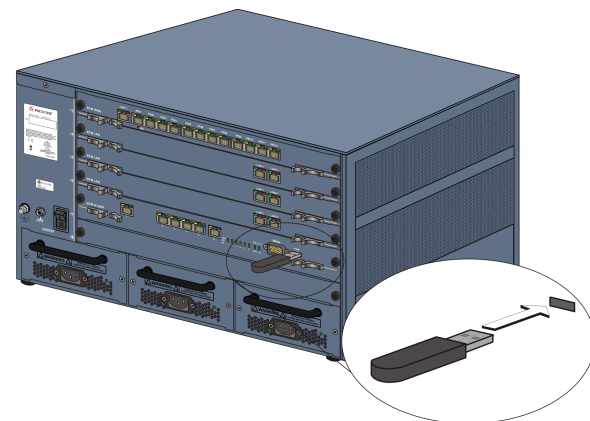

- 2 Power the RMX **ON**.  
The parameters in the **lan.cfg** file are uploaded from the USB key to the RMX's memory and applied during the power-up sequence. System power-up sequence may take up to **five** minutes.

During the first-time power-up the red ERR LED on the RMX's front panel remains ON until both the *Management* and *IP Network Services* have been defined.

- 3 Remove the *USB key*.  
Enter the IP address of the RMX Control Unit and press Enter.

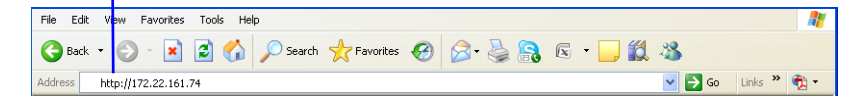

- 4  
5  
6
- 
- Enter POLYCOM.  
Enter POLYCOM.  
Click **Login**.

- 5  
6
- 
- Click to connect to Polycom web site and register the RMX.  
Click **Product Registration** and follow the on screen instructions to obtain the *Product Activation Key*.  
Enter or paste the *Product Activation Key* obtained.  
Click **OK**.

## Modifying the Default IP Service

This section describes the definition of H.323 Network Service. For detailed description of H.323, SIP and ISDN Network Service definitions, see the *RMX Getting Started Guide*, “First Time Installation and Configuration”.

On the RMX 4000, IPv4 is the default protocol for setting the Network Service in the *Fast Configuration Wizard*.

In the *Fast Configuration Wizard*, select **Next** to move from one window to another.

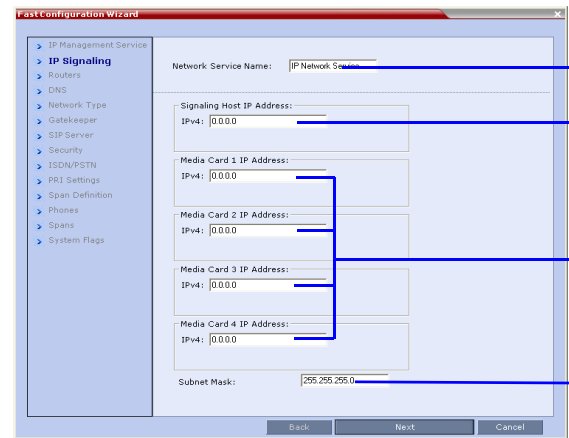

Change the default service name if required.

Enter the address to be used by IP endpoints when dialing in to the MCU.

Enter the IP address(es) of the media card(s).

Enter the subnet mask of the MCU.

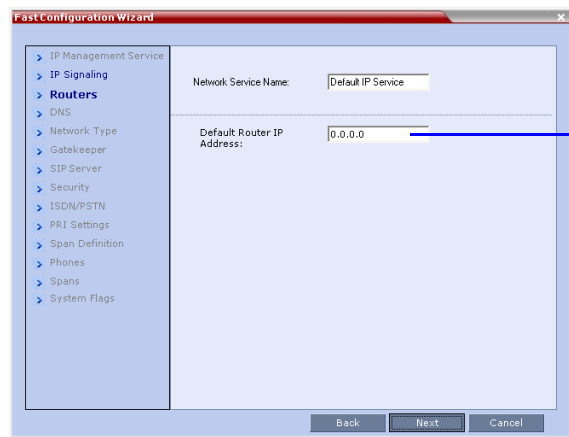

Enter the IP address of the default router.

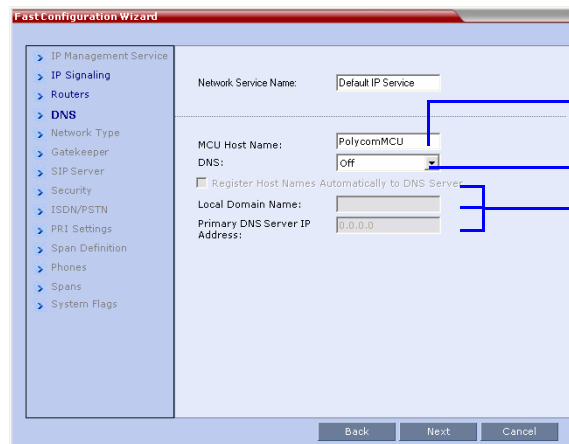

Enter the name of the MCU on the network.

Optional. Select **Specify** to define a DNS server.

Optional. Define the DNS server properties:

- Registration mode
- The name of the MCU domain
- The static IP address of the primary DNS server

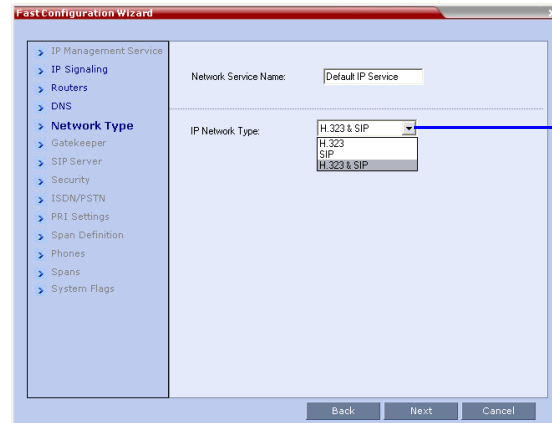

Select **H.323** as the IP Network Type.

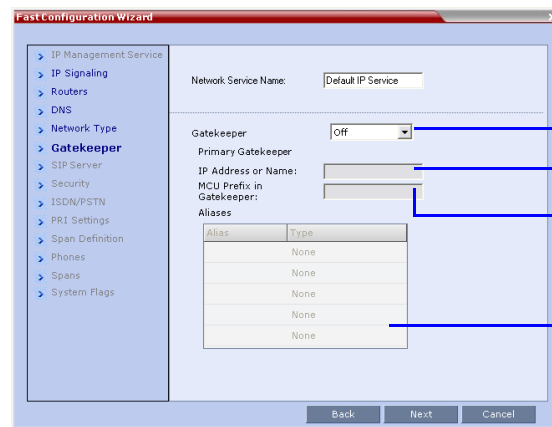

Select **Specify** to configure the gatekeeper parameters.

Enter gatekeeper's host name or IP address.

Enter the string with which the MCU registers itself with the gatekeeper.

Enter the alias that identifies the RMX's Signaling Host within the network. Up to five aliases can be defined for each RMX.

In the IP Network Service creation confirmation, click **OK**.

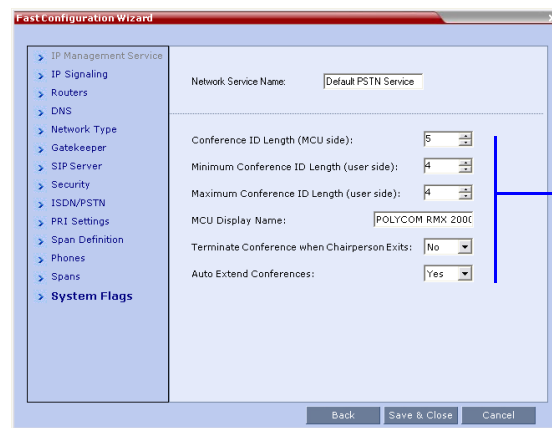

Optional. Modify the default settings of the system flags that define the general system behavior such as the number of digits in the conference ID assigned by the MCU.

These flags can be modified later, if required, by selecting the *System Configuration* option from the *Setup* menu.

Click **Save & Close**.

In the *Success Message* box confirming successful configuration, click **OK**.

In the *Reset Confirmation* dialog box, click **Yes**.

In the *Please wait for system reset* message box, click **OK**. **System restart may take up to five minutes.**

Refresh the browser periodically until the Login screen is displayed and *Login*. In the *Main Screen* an *MCU State* indicator displays the time remaining until the system start-up is complete.

**13** Create a new **User** with Administrator permissions and delete the default User (POLYCOM). For system security reasons, only when this step is completed and if there are no *System Errors*, the system is fully configured and the green RDY LED on the CNTL module (on the RMX's front panel) turns ON.

## Connecting to a Conference Directly or via Entry Queue (EQ)

The RMX is shipped with pre-configured default conferencing entities that can be used to dial in and start conferences. Default (Transit) Entry Queue ID: 1000, default Meeting Room IDs: 1001, 1002, 1003, and 1004.

### H.323 Participants

H.323 participants dial:

**[MCU Prefix in Gatekeeper][Conference or Entry Queue ID/Name]**

For example, if the MCU prefix in gatekeeper is 925, you can dial to the default (Transit) Entry Queue by entering 925 or 9251000 and be routed to Meeting Rooms by entering its ID (i.e. 1001, 1002, 1003 or 1004). You can connect directly to one of the default Meeting Rooms, by dialing its number, for example: 9251001.

Alternatively, you can use the Entry Queue or conference name to connect directly to the conference. For example, if the conference name is Maple\_Room, the participant can dial: 925Maple\_Room.

### SIP Participants

The dialing string is composed of the conference routing name as registered with the SIP server and domain name in the format: **conference\_name@domain\_name**

For example, if conference routing name is 1001, the string is 1001@polycom.com.

### ISDN and PSTN Participants

ISDN and PSTN participants can connect to conferences and Meeting Rooms directly or via an Entry Queue by dialing one of the numbers (including the country and area code if needed) assigned to the conference, Meeting Room or Entry Queue. When connecting to an EQ they are routed to their conference according to the conference ID. For example, if the assigned dial in number is 4045555, the ISDN/PSTN endpoint dials this number with the appropriate area code (for example, 678) and country code (001).

## Conference Control Using DTMF Codes

Operation	DTMF String	Operation	DTMF String
Mute My Line	*6	Request individual assistance	*0
Unmute My Line	#6	Request assistance for conference	00
Increase Broadcast Volume	*9	Increase Listening Volume	*76
Decrease Broadcast Volume	#9	Decrease Listening Volume	#76
Play Help Menu	*83	Change To Chairperson	*78
Start Click&View to modify personal layout	**	Show Number of Participants	*88