



# AXIS 241QA/AXIS 241SA Video Server User's Manual

## About This Document

This manual is intended for administrators and users of Axis video servers. This manual describes AXIS 241QA/AXIS 241SA, with firmware release 4.47. The manual includes instructions for using and managing the AXIS 241QA/AXIS 241SA on your network. Previous experience of networking will be of use when installing and using this product. Some knowledge of UNIX or Linux-based systems would also be beneficial, for developing shell scripts and applications. Later versions of this document will be posted to the Axis Website, as required. See also the product's online help, available via the Web-based interface.

## Safety Notices Used In This Manual

**Caution!** - Indicates a potential hazard that can damage the product.

**Important!** - Indicates a hazard that can seriously impair operation.

Do not proceed beyond any of the above notices until you have fully understood the implications.

## Intellectual Property Rights

Axis AB has intellectual property rights relating to technology embodied in the product described in this document. In particular, and without limitation, these intellectual property rights may include one or more of the patents listed at <http://www.axis.com/patent.htm> and one or more additional patents or pending patent applications in the US and other countries.

This product contains licensed third-party software. See the menu item "About" in the product's user interface for more information.

## Legal Considerations

Camera and audio surveillance can be prohibited by laws that vary from country to country. Check the laws in your local region before using this product for surveillance purposes. This product includes one (1) MPEG-4 decoder license. To purchase further licenses, contact your reseller.

## Electromagnetic Compatibility (EMC)

This equipment generates, uses and can radiate radio frequency energy and, if not installed and used in accordance with the instructions, may cause harmful interference to radio communications. However, there is no guarantee that interference will not occur in a particular installation. If this equipment does cause harmful interference to radio or television reception, which can be determined by turning the equipment off and on, the user is encouraged to try to correct the interference by one or more of the following measures: Re-orient or relocate the receiving antenna. Increase the separation between the equipment and receiver. Connect the equipment to an outlet on a different circuit to the receiver. Consult your dealer or an experienced radio/TV technician for help. Shielded (STP) network cables must be used with this unit to ensure compliance with EMC standards.

**USA** - This equipment has been tested and found to comply with the limits for a Class B computing device pursuant to Subpart B of Part 15 of FCC rules, which are designed to provide reasonable protection against such interference when operated in a commercial environment. Operation of this equipment in a residential area is likely to cause interference, in which case the user at his/her own expense will be required to take whatever measures may be required to correct the interference.

**Europe - CE** This digital equipment fulfills the requirements for radiated emission according to limit B of EN55022/1998, and the requirements for immunity according to EN55024/1998 residential, commercial, and light industry.

## Liability

Every care has been taken in the preparation of this manual; Please inform your local Axis office of any inaccuracy or omission. Axis Communications AB cannot be held responsible for any technical or typographical errors and reserves the right to make changes to the product and manuals without prior notice. Axis Communications AB makes no warranty of any kind with regard to the material contained within this document, including, but not limited to, the implied warranties of merchantability and fitness for a particular purpose. Axis Communications AB shall not be liable nor responsible for incidental or consequential damages in connection with the furnishing, performance or use of this material.

## Trademark Acknowledgments

Ethernet, Internet Explorer, Linux, Microsoft, Mozilla, OS/2, UNIX, Windows, WWW are registered trademarks of the respective holders. QuickTime™ is a trademark of Apple Computer, Inc., registered in the U.S. and other countries. Java and all Java-based trademarks and logos are trademarks or registered trademarks of Sun Microsystems, Inc. in the United States and other countries. Axis Communications AB is independent of Sun Microsystems Inc. UPnP™ is a certification mark of the UPnP™ Implementers Corporation.

## Support Services

Should you require technical assistance, please contact your Axis reseller. If your questions cannot be answered immediately, your reseller will forward your queries through the appropriate channels to ensure a rapid response. If you are connected to the Internet, you can:

- download user documentation and firmware updates
- find answers to resolved problems in the FAQ database. Search by product, category, or phrases
- report problems to Axis support staff by logging in to your private support area
- visit the Axis Support Web at [www.axis.com/techsup/](http://www.axis.com/techsup/)

## Safety Notice - Battery Replacement

The AXIS 241QA/AXIS 241SA uses a 3.0V CR2032 Lithium battery as the power supply for its internal real-time clock (RTC). This battery will, under normal conditions, last for a minimum of 5 years. Low battery power affects the operation of the RTC, causing it to reset at every power-up. A log message will appear when battery replacement is required.

The battery should not be replaced unless required!  
If the battery does need replacing, observe the following points:

### Caution!

- Danger of Explosion if battery is incorrectly replaced
- Replace only with the same or equivalent battery, as recommended by the manufacturer.
- Dispose of used batteries according to the manufacturer's instructions.

AXIS Video Servers User's Manual  
Revision 2.1  
Dated: January 2009  
Part No: 32569  
Copyright© Axis Communications AB, 2006-2009

# Table of contents

---

- Product description . . . . . 5
  - Overview of the AXIS video server . . . . . 5
  - AXIS 241QA . . . . . 6
  - AXIS 241SA . . . . . 6
  - LED indicators . . . . . 6
  - Switches & connectors . . . . . 7
  - Rear panel . . . . . 7
- Using the video server . . . . . 9
  - Accessing the video server . . . . . 9
  - Setting the root password . . . . . 10
  - The Live View Page . . . . . 11
- Video and audio streams . . . . . 13
  - Video stream types . . . . . 13
  - MPEG-4 protocols and communication methods . . . . . 14
  - AXIS Media Control (AMC) . . . . . 14
  - How to stream MPEG-4 . . . . . 14
  - Other methods of accessing the video stream . . . . . 15
- Configuring the video server . . . . . 17
- Video & image settings . . . . . 18
  - Image settings . . . . . 18
  - Video source settings . . . . . 19
  - Advanced . . . . . 19
  - Quad stream settings . . . . . 20
  - Overlay/Mask settings . . . . . 20
- Audio . . . . . 23
- Live View Config . . . . . 27
  - Layout . . . . . 27
  - HTML Examples . . . . . 30
  - External Video . . . . . 31
  - Sequence Mode . . . . . 31
- Pan Tilt Zoom . . . . . 32
  - Installing PTZ devices . . . . . 32
  - PTZ configuration . . . . . 33
  - PTZ controls . . . . . 34
  - PTZ control queue . . . . . 37

Event configuration .....	39
Event servers .....	39
Event types .....	40
Camera tampering .....	42
Motion detection .....	43
Port status .....	44
System options .....	45
Security .....	45
Date & time .....	48
Network - Basic TCP/IP settings .....	49
Network - Advanced TCP/IP settings .....	50
Ports & devices .....	54
Maintenance .....	54
Support .....	54
Advanced .....	55
Resetting to the factory default settings .....	56
Unit connectors .....	57
The D-Sub connector .....	57
The I/O terminal connector .....	58
Schematic diagram - I/O terminal connector .....	59
COM ports RS-232 and RS-485 .....	59
	60
Troubleshooting .....	61
Checking the firmware .....	61
Upgrading the firmware .....	61
Support .....	62
Technical specifications .....	66
General performance considerations .....	69
Optimizing your system .....	69
Frame rates - Motion JPEG .....	70
Frame rates - MPEG-4 .....	70
Bandwidth .....	71
Glossary .....	72
Index .....	81

## Product description

---

This manual describes the AXIS 241QA: 4-port video server including 2-way audio, and the AXIS 241SA: 1-port video server including 2-way audio.

### Overview of the AXIS video server

The Axis video server is fully featured for security surveillance and remote monitoring needs. It is based on the AXIS ARTPEC-2 compression chip, and can digitize up to four analog video sources and make these available on the network as real-time, full frame rate Motion JPEG and/or MPEG-4 video streams.

The Axis video server is equipped with RS-232 and RS-485 ports for connecting third party PTZ systems. The 4 alarm inputs and four alarm outputs can be used to connect various third party devices, such as door sensors and alarm bells.

Up to 20 viewers can access the Axis video server simultaneously when using Motion JPEG and MPEG-4 unicast. The number of simultaneous viewers can be increased by using multicast MPEG-4. When using AXIS Media Control (AMC) to view MPEG-4 video streams, each MPEG-4 viewer requires a separate MPEG-4 decoder license. One license is included, and further licenses can be purchased separately from your Axis dealer. If using other clients to view the MPEG-4 video stream, no further MPEG-4 decoder licenses are required.

Video can be viewed in five resolutions (up to 4CIF), and image compression is configurable. The Axis video server contains support for video motion detection, which allows the unit to trigger on activity in the video image, and advanced scheduling tools which can also be used to trigger an event. As the Axis video server is designed for use in security systems, it is equipped with several security features, such as IP address filtering, several user levels with passwords and HTTPS.

The Axis video server has a built-in web server, providing full access to all features through the use of a web browser. The built-in scripting tool allows basic applications to be created, providing basic surveillance solutions. For advanced functionality, the video server can be integrated via the use of VAPIX® Axis Communications' powerful API (see [www.axis.com/developer](http://www.axis.com/developer) for further information).

## AXIS 241QA

The AXIS 241QA provides 4 BNC inputs for connecting analog video devices.

The AXIS 241QA also provides a Line/Microphone In (mono) connector for connecting an external microphone or other source, producing a line level signal. An active speaker with a built-in amplifier can be connected to Line Out (mono), to enable two-way communication. Audio communication can be bi-directional (full-duplex), push to talk (half-duplex) or in one direction only (simplex).

### Front panel - AXIS 241QA

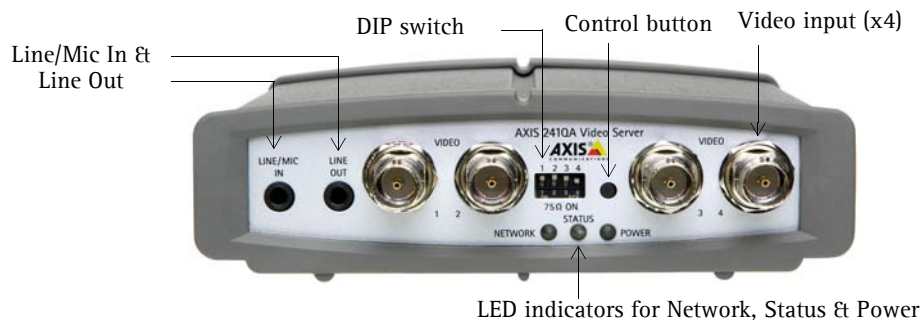

## AXIS 241SA

The AXIS 241SA provides 1 BNC input and 1 matching loop-through output. This model can also accommodate S-Video (Y/C) by using a Y/C to BNC cable (not included).

The AXIS 241SA also provides a Line/Mic In (mono) connector for connecting an external microphone or other source producing a line level signal. An active speaker with a built-in amplifier can be connected to Line Out (mono) to enable two-way communication. Audio communication can be bi-directional (full-duplex), push to talk (half-duplex) or in one direction only (simplex).

## LED indicators

After completion of the startup and self-test routines, the multi-colored LED indicators signal the following conditions:

Network	Unlit	No connection.
	Green	Steady for connection to a 100 Mbit/s network. Flashes for network activity.
	Amber	Steady for connection to a 10 Mbit/s network. Flashes for network activity.
Status	Unlit	When configured for "no flash" on access.
	Green	Steady for normal operation. Can be configured to flash green at intervals whenever the unit is accessed.
	Amber	Steady during startup, reset to factory default or when restoring settings.
	Red	Slow flash for failed firmware upgrade.

Power	Green	Normal operation.
	Amber	Flashes green/amber during firmware upgrade.

## Switches & connectors

**DIP switch** - A corresponding line termination switch is supplied for each video input. All units are shipped with line termination enabled for each video input; that is, with the DIP switch set in the down position.

**Note:** If the video source is to be connected in parallel with other equipment, disable the input termination by turning the corresponding DIP switch to the up position (OFF). Failure to do so may cause reduced image quality.

**Control Button** - Press this button to restore the factory default settings, as described in *Resetting to the factory default settings*, on page 56. This button is also used to install the video server using AXIS Internet Dynamic DNS Service (See the Axis Video Server Installation Guide).

**Video Input** - Each supported video input (1 or 4 depending on the model) is connected using a coax/BNC connector. Physical connections made using a 75 ohm coaxial video cable have a recommended maximum length of 800 feet (250 meters).

**Line Out** - Mono audio output (line level), which can be connected to a public address (PA) system or an active speaker with a built-in amplifier. A pair of headphones can also be attached.

**Line/Mic In** - Single 3.5 mm input for a mono microphone, or line level mono signal (only the left channel is used from a stereo signal).

## Rear panel

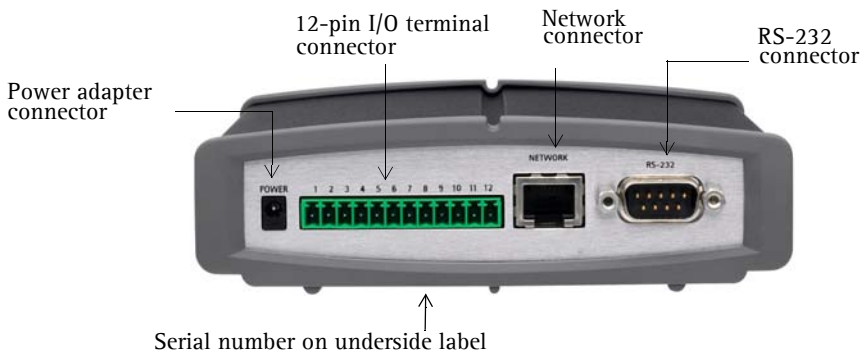

**Power adapter connector** - For connecting the power adapter.

**I/O terminal connector** - The I/O terminal connector provides the physical interface to four digital transistor outputs, 4 digital inputs and an RS-485 interface. See *Unit connectors*, on page 57 for more information.

**Note:** The I/O terminal connector also provides an auxiliary connection point for DC power.

**Network connector** - The Axis video server connects to the network via a standard network cable, and automatically detects the speed of the local network segment (10BaseT/100BaseTX Ethernet).

**RS-232 connector** - A 9-pin D-SUB connector providing an RS-232 serial connection. Typically used for connecting Pan/Tilt/Zoom devices. See *Unit connectors*, on page 57 for more information.



# Using the video server

The AXIS 241QA/AXIS 241SA can be used with most operating systems and web browsers. The recommended browser is Internet Explorer with Windows, and Mozilla with other operating systems. See also the *Technical specifications*, on page 66.

**Note:** For information on installing the video server, please refer to the Installation Guide.

## Accessing the video server

1. Start your web browser.
2. Enter the IP address or host name of the AXIS 241QA/AXIS 241SA in the Location/Address field of your browser.
3. If you are accessing the camera for the first time, see *Setting the root password*, on page 10. Otherwise enter your user name and password, as set by the administrator.
4. A video image is displayed in your browser.

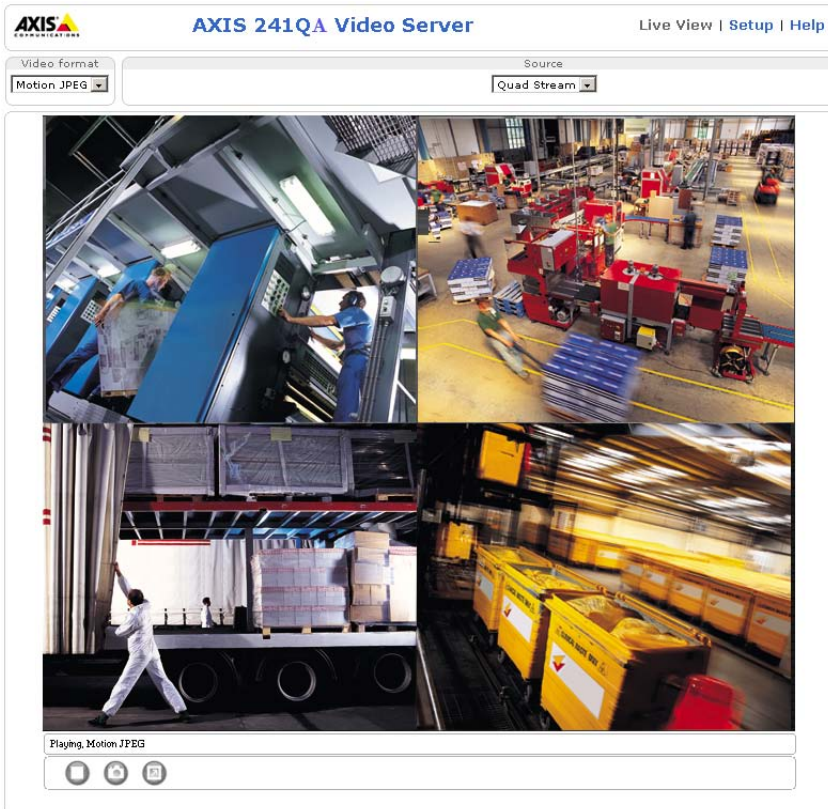
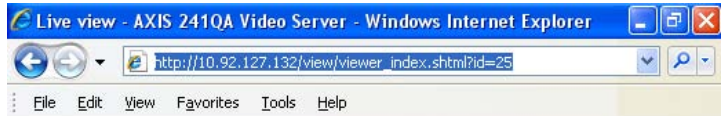

- Notes:**
- To view streaming video in Microsoft Internet Explorer, you must set your web browser to allow the AXIS Media Control (AMC) to be installed on your computer. AMC is required to use audio in the AXIS 241QA/AXIS 241SA. AMC also provides an MPEG-4 decoder for viewing MPEG-4 video streams. This decoder is installed the first time an MPEG-4 video stream is accessed. Please note that the product administrator may have disabled the installation of the decoder, as a license is required for each instance.
  - If your computer restricts the use of additional software components, the AXIS 241QA/AXIS 241SA can be configured to use a Java applet for updating JPEG images. Please see the online help for more information.
  - When using a browser other than Microsoft Internet Explorer with AMC, instead of a stop, a snapshot and a full screen button, there is a stop and a play button in the bottom left corner of the live view page. For a description of these buttons see *The Live View Page*, below.

## Setting the root password

1. When accessing a camera for the first time, the 'Configure Root Password' dialog is displayed on the screen.

**AXIS**  
COMMUNICATIONS

### Create Certificate

Secure configuration of the root password via HTTPS requires a self-signed certificate.

---

### Configure Root Password

User name: root

Password:

Confirm password:

The password for the pre-configured administrator root must be changed before the product can be used.

If the password for root is lost, the product must be reset to the factory default settings, by pressing the button located in the product's casing. Please see the user documentation for more information.

**Note:** Before you enter your password at this point, you can secure configuration of the root password via HTTPS by creating a self-signed certificate. To do so, click the **Create self-signed certificate...** button in the **Create Certificate** window, and then proceed as follows.

2. Enter a password, and re-enter to confirm the spelling. Click OK.
3. The 'Enter Network Password' dialog appears. Enter the User name: root

**Note:** The default administrator user name root is permanent and cannot be deleted.

4. Enter the password as set in step 2 above, and click OK. If the password is lost, the cameras must be reset to the factory default settings. See page 56.

- If required, click Yes to install the AXIS Media Control (AMC). You will need administrator rights on the computer to do this.

## The Live View Page

If your AXIS 241QA/AXIS 241SA has been customized to meet specific requirements, all the buttons and other items described below may not be displayed on the Live View page. Below you have an overview of all the buttons:

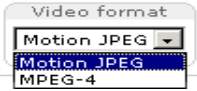

The Video Format drop-down list allows the video format on the Live View page to be temporarily changed.

The Output buttons control an output directly from the Live View page. These buttons are configured under Setup > Live View Config > Layout.



**Pulse** - click this button to activate the port for a defined period of time, such as switching on a light for 20 seconds.



**Active/Inactive** - click these buttons to manually start and stop a connected device, such as switching a light on/off.



These buttons start/stop the **Sequence Mode**. This mode is created in Setup > Live View Config > Sequence mode and automatically displays the view from two or more video sources at set intervals.



From the **Source** list, select the desired video image(s). The list can contain internal video sources, external video sources, or the Quad Stream view. The **Quad Stream** option displays all four video images in one stream.



The **trigger buttons** trigger an event directly from the Live View page. These buttons are configured under Setup > Live View Config > Layout. Click these buttons to manually start and stop events.





Use the **Snapshot** button to capture a snapshot of the image currently displayed in the window. Right-click on the image to save it in on your computer.

The AMC viewer toolbar (AXIS Media Control) is available in **Microsoft Internet Explorer only** and displays the following buttons:



The **Play/Stop** buttons start and stop the media stream.

-  The **Snapshot** button saves a snapshot of the video image currently displayed. The Snapshot function and the target directory for saving snapshots can be configured from the AMC Control Applet, which can be opened from the Windows Control Panel or by right-clicking the image.
-  Click the **View Full Screen** button and the video image will fill the entire screen area. No other windows will be visible. Press Esc (Escape) on your keyboard to cancel full screen view.
-  Click the **Record** button to start an MPEG-4 recording (only available when viewing MPEG-4).

### AMC Audio controls

There are audio controls for controlling the client computer's speaker output. These controls are only available in the MPEG-4 video format and when audio is enabled, see *Audio Settings*, on page 23.

-  Click the **Speaker** and **Microphone** buttons to switch the sound off and on, for the speaker and microphone, respectively.



Use the slider to control the volume on the speaker and microphone. The volume can be set between 0 and 100.

-  When using **Half-duplex** mode, this button toggles between allowing you to speak and listen. The first icon indicates that you can talk and the speaker attached to the video server plays your voice. The second icon indicates that you will hear audio from the video server, but no audio is sent to web clients. When in **simplex** talk mode, the icon toggles between allowing you to speak, and is dimmed when you do not want other clients to receive any audio.

Note that these AMC toolbar functions can also be accessed by right-clicking in the image. For information on using Pan/Tilt/Zoom controls, please see *Pan Tilt Zoom*, on page 37.

## Video and audio streams

---

The AXIS 241QA/AXIS 241SA provides several different video and audio stream formats. The type to use depends on your requirements and on the properties of your network.

The Live View page in the AXIS 241QA/AXIS 241SA provides access to Motion JPEG and MPEG-4 video and audio streams, as well as to single JPEG images. Other applications and clients can also access these video and audio streams/images directly, without going via the Live View page.

### Video stream types

#### Motion JPEG

This format uses standard JPEG still images in the video stream. These images are then displayed and updated at a rate sufficient to create a stream that shows constantly updated motion.

The Motion JPEG stream provides excellent image quality and access to each and every individual image contained in the stream.

Note also that multiple clients accessing Motion JPEG streams can use different image settings.

#### MPEG-4

This is a video compression standard that makes good use of bandwidth, and which can provide high-quality video streams at less than 1 Mbit/s.

The MPEG-4 standard provides scope for a large range of different coding tools for use by various applications in different situations, and the AXIS 241QA/AXIS 241SA provides certain subsets of these tools. These are represented as **Video object types**, which are selected for use with different viewing clients. The supported video object types are:

- **Simple** - sets the coding type to H.263
- **Advanced Simple** - in Axis products, this sets the coding type to MPEG-4 Part 2

AMC (AXIS Media Control) supports both object types, while QuickTime™ requires the Simple object type. When using MPEG-4 it is also possible to control the bit rate, which in turn allows the amount of bandwidth usage to be controlled. CBR (constant bit rate) is used to achieve a specific bit rate by varying the quality of the MPEG-4 stream. When using VBR (variable bit rate), the quality of the video stream is kept as constant as possible, at the cost of a varying bit rate.

- Notes:**
- MPEG-4 is licensed technology. The AXIS 241QA/AXIS 241SA includes one license for the decoder required for viewing in AMC. Installing additional unlicensed copies of this decoder is prohibited. To purchase more decoder licenses, contact your Axis reseller.
  - All clients viewing the MPEG-4 stream must use the same image settings.

## MPEG-4 protocols and communication methods

To deliver live streaming video over IP networks, various combinations of transport protocols and broadcast methods are employed.

- RTP (Real-Time Transport Protocol) is a protocol that allows programs to manage the real-time transmission of multimedia data, via unicast or multicast.
- RTSP (Real-Time Streaming Protocol) serves as a control protocol, to negotiate which transport protocol to use for the stream. RTSP is thus used by a viewing client to start a unicast session, see below.
- UDP (User Datagram Protocol) is a communications protocol that offers limited service for exchanging data in a network that uses the Internet Protocol (IP). UDP is an alternative to the Transmission Control Protocol (TCP). The advantage of UDP is that it is not required to deliver all data and may drop network packets when there is network congestion. This is suitable for live video, as there is no point in re-transmitting old information that will not be displayed anyway.
- Unicasting is communication between a single sender and a single receiver over a network. This means that the video stream goes independently to each user, and each user gets their own stream. A benefit of unicasting is that if one stream fails, it only affects one user.
- Multicast is bandwidth-conserving technology that reduces bandwidth usage by simultaneously delivering a single stream of information to multiple network recipients. This technology is used primarily on delimited networks (intranets), as each user needs an uninterrupted data flow and should not rely on network routers.

## AXIS Media Control (AMC)

The recommended method of accessing live video and audio from the AXIS 241QA/AXIS 241SA is to use the AXIS Media Control (AMC) in Microsoft Internet Explorer in Windows. This ActiveX component is automatically installed on first use, after which it can be configured by opening the AMC Control Panel applet from the Windows Control Panel. Alternatively, right-click the video image in Internet Explorer.

## How to stream MPEG-4

Deciding on the combination of protocols and methods to use depends on your viewing requirements, and on the properties of your network. Setting the preferred method(s) is done in the control applet for AMC, which is found in the Windows Control Panel. When this has been set, AMC will test all the selected methods in the specified order, until the first functioning one is found.

### RTP+RTSP

This method (actually RTP over UDP and RTSP over TCP) should be your first consideration for live video, especially when it is important to always have an up-to-date video stream, even if some images do get dropped. This can be configured as multicast or unicast.

Multicasting provides the most efficient usage of bandwidth, especially when there are large numbers of clients viewing simultaneously. Note however, that a multicast broadcast cannot pass a network router unless the router is configured to allow this. It is thus not possible to multicast over the Internet, for example.

Unicasting should be used for video-on-demand broadcasting, so that there is no video traffic on the network until a client connects and requests the stream. However, if more and more unicast clients connect, the server will at some point become overloaded. There is also a maximum of 20 simultaneous viewers to be considered.

### RTP/RTSP

This unicast method is RTP tunneled over RTSP. This can be used to exploit the fact that it is relatively simple to configure firewalls to allow RTSP traffic.

### RTP/RTSP/HTTP or RTP/RTSP/HTTPS

These two methods can also be used to traverse firewalls. Firewalls are commonly configured to allow the HTTP protocol, thus allowing RTP to be tunneled.

## Other methods of accessing the video stream

Video/images from the AXIS 241QA/AXIS 241SA can also be accessed in the following ways:

- If supported by the client, the AXIS 241QA/AXIS 241SA can use Motion JPEG server push to display video. This option maintains an open HTTP connection to the web browser and sends data as and when required, for as long as required.
- As single JPEG images in a browser. Enter the path:  
http://<ip>/axis-cgi/jpg/image.cgi?resolution=CIF
- Windows Media Player. This requires AMC and the MPEG-4 decoder to be installed. The paths that can be used are listed below, in the order of preference.
- Unicast via RTP: axrtpu://<ip>/mpeg4/#/media.amp
- Unicast via RTSP: axrtsp://<ip>/mpeg4/#/media.amp
- Unicast via RTSP, tunneled via HTTP: axrtsphhttp://<ip>/mpeg4/#/media.amp
- Unicast via RTSP, tunneled via HTTPS: axrtsphhttps://<ip>/mpeg4/#/media.amp
- Multicast: axrtpm://<ip>/mpeg4/#/media.amp

### Notes:

- <ip> = IP address.
- # = video source number or the quad stream. This is set to 1 if omitted.



## Other MPEG-4 clients

Although it may be possible to use other clients to view the MPEG-4 stream, it is not guaranteed to work in all cases. For some other clients, such as QuickTime™ the Video Object Type must be set to *Simple*. It may also be necessary to adjust the advanced MPEG-4 settings.

To access the video stream from e.g. QuickTime™ the following path can be used:

```
rtsp://<ip>/mpeg4/#/media.amp
```

This path is for all supported methods, and the client will negotiate with the AXIS 241QA/AXIS 241SA to determine exactly which transport protocol to use.

- Notes:**
- <ip> = IP address.
  - # = video source number or the quad stream. This is set to 1 if omitted.

## Audio transmission methods

The audio stream can be accessed in the Live View page when viewing either Motion JPEG or MPEG-4.

### Using Motion JPEG

The basic transmission method of audio used in conjunction with Motion JPEG video streaming is transmission over HTTP. The video and audio streams are not synchronized when using Motion JPEG so the streams may be slightly out of sync. The latency in any stream should be low, but this will depend on the network infrastructure.

### Using MPEG-4

When using MPEG-4, audio is streamed using the same protocol as the video stream.

When audio is transmitted using MPEG-4, the Axis video server sends synchronization information along with the streams to the client performing the synchronization.

**Note:** Audio is streamed from the client to the server over HTTP when using Motion JPEG and MPEG-4.

## Accessing the audio streams

In addition to accessing audio in the Live View page using AMC, audio from the AXIS 241QA/AXIS 241SA can also be accessed in the following ways:

### AXIS VAPIX API

You can read about accessing audio for the other protocols through the VAPIX® API at [www.axis.com/techsup](http://www.axis.com/techsup)

### QuickTime/Windows Media Player

It is possible to use QuickTime and Windows Media Player to listen to the audio stream using the same methods to access video streams.

### Java Applet

The Java applet supports simplex audio.



# Configuring the video server

This section describes how to configure the AXIS 241QA/AXIS 241SA and is intended for administrators, who have unrestricted access to all the Setup tools

The AXIS 241QA/AXIS 241SA is configured from the **Setup** link in a web browser. For more information on supported browsers, see the *Technical specifications*, on page 66.

## Accessing the Setup tools

Follow the instructions below to access the Setup Tools from a web browser.

1. Start the browser and enter the IP address or host name of the AXIS 241QA/AXIS 241SA in the location/address field.
2. The Live View page is now displayed. Click **Setup** to display the Setup tools.



## Video & image settings

Below you find examples of the features available in the AXIS 241QA/AXIS 241SA. For details of each setting, please refer to the online help available from each page. Click  to access the online help.

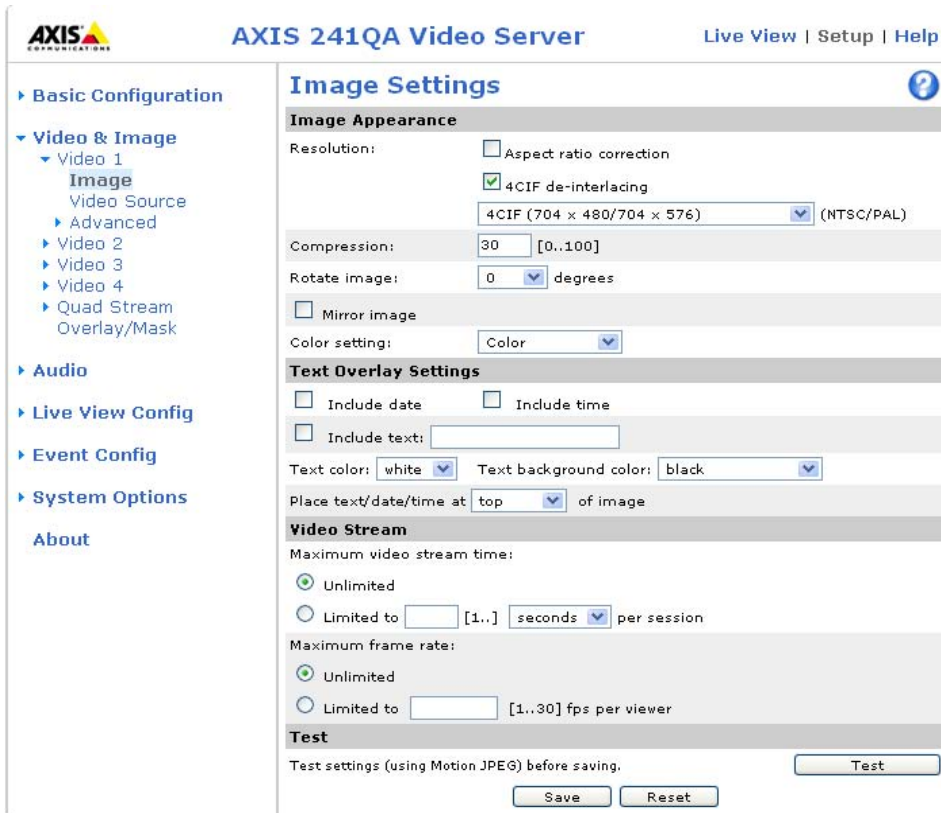

**AXIS 241QA Video Server** Live View | Setup | Help

**Image Settings** 

**Image Appearance**

Resolution:  Aspect ratio correction  
 4CIF de-interlacing  
 4CIF (704 x 480/704 x 576) (NTSC/PAL)

Compression: 30 [0..100]

Rotate image: 0 degrees

Mirror image

Color setting: Color

**Text Overlay Settings**

Include date  Include time

Include text:

Text color: white Text background color: black

Place text/date/time at: top of image

**Video Stream**

Maximum video stream time:

Unlimited  
 Limited to  [1..] seconds per session

Maximum frame rate:

Unlimited  
 Limited to  [1..30] fps per viewer

**Test**

Test settings (using Motion JPEG) before saving.

### Image settings

#### Image appearance

Modify image appearance to optimize the video images according to your requirements.

All configuration of images and overlays will affect the performance of the video server, depending on the usage and the available bandwidth.

- High resolution generates larger files
- Lower compression improves image quality, but generates larger files
- Rotating the image 90 or 270 degrees will lower the maximum frame rate
- Black & White uses less bandwidth than Color

See also the specifications for frame rates and bandwidth on page 70.

## Mirroring

Mirroring is the horizontal flipping of an image, that gives you another image perspective. This is a useful function when you need a direct view of the image, for example, in ATMs and door phones. The mirroring settings should be defined before you define the parameters for privacy masks and motion detection.

## Text overlay settings

Include date, time and/or text of your choice to be viewed on the image. The color of the text may be set to white or black, while the background color may be set to white, black, transparent or semitransparent. The position of the text is set either to the top or the bottom of the image. For more information, please see the online help [?](#).

## Video stream

The **Maximum video stream time** can be set as Unlimited, or set per session in seconds, minutes or hours. When the set time has expired, a new stream on the Live View page can be started by refreshing the page in the web browser. Note that the maximum video stream time does not apply to clients connecting via multicast.

To avoid bandwidth problems on the network, the frame rate allowed to each viewer can also be limited. Select either **Unlimited** or define a **Maximum frame rate** per viewer.

## Test

For a preview of the image and overlay settings before saving, click **Test**. When you are satisfied with the settings, click **Save**.

## Video source settings

These settings allow you to:

- enter a descriptive name for the video source
- eliminate black borders surrounding the image, by making **Offset adjustments**.  
See the online help for more information [?](#).

AXIS 241SA:

Select the physical connector the video source is connected to, BNC or Y/C.

- BNC (composite video) connects a standard video camera or other video equipment
- Y/C (S-video) connects a Y/C (S-Video) camera or other video equipment

## Advanced

### MPEG-4 settings

These settings are the tools for adjusting the MPEG-4 settings and for controlling the video bit rate.

The MPEG-4 standard provides many different coding tools for various applications in different situations. As most MPEG-4 clients do not support all of these tools, it is usual to instead define and use subsets for different clients or groups of clients. These settings allow you to define the type of viewing client to use.

Adjusting the maximum bit rate and setting it to variable or constant is a good way of controlling the bandwidth used by the MPEG-4 video stream.

## MJPEG

Sometimes the image size is large due to low light or complex scenery. Adjusting the maximum frame size helps to control the bandwidth and storage used by the MJPEG video stream in these situations. Defining the frame size as Unlimited provides consistently good image quality at the expense of increased bandwidth and storage usage during low light. Limiting the frame size optimizes bandwidth and storage usage, but gives poor image quality. To prevent increased bandwidth and storage usage, the maximum frame size should be set to an optimal value.

For more information on these advanced settings, please see the online help.

## Quad stream settings

A Quad stream enables you to monitor all channels at the same time. Instead of having four Internet Explorer windows open, you can have just one window open with the Quad view. You can edit this view with the desired stream time, frame rate, and text overlay. These settings are the same as the Image Settings. See page 18.

## Overlay/Mask settings

### Overlay/Mask type

Overlay/Mask type allows you to place an overlay, or up to three privacy masks over the video image:

- Upload and place an image as an overlay - usually used to provide extra information in the video image.
- Place up to three configurable privacy masks to conceal different areas of the video image.



Selecting the overlay/mask type from the menu will display further settings available for the selected type. See the online help for further information.

**Note:** A privacy mask cannot be bypassed, but an overlay image can be bypassed with the help of the VAPIX® API.

### Upload and use an overlay image

1. Select **Uploaded image** as overlay in the drop-down list against **Overlay/Mask Type**.
2. In the field **Upload own image**, click the **Browse** button and locate the image file on your computer or server.
3. Click the **Upload** button and follow the on-screen instructions.

To use an already uploaded image:

1. Select an uploaded image from the **Use image** drop-down list.
2. Place the image at the required location by entering the x and y coordinates.
3. Click **Save**.

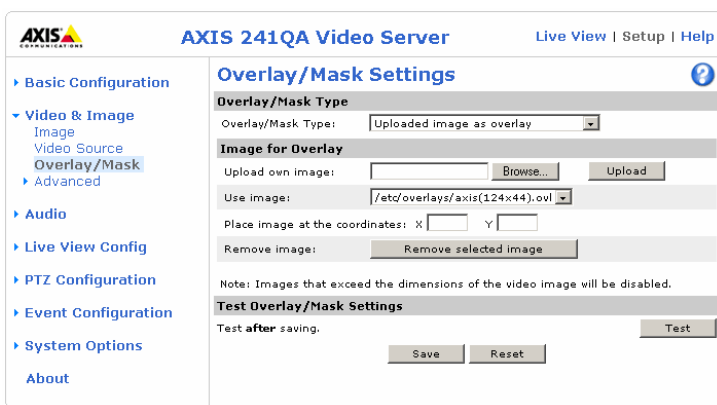

### Overlay image requirements:

Image Formats	Image Size
<ul style="list-style-type: none"> <li>• Windows 24-bit BMP (full color)</li> <li>• Windows 4-bit BMP (16 colors)</li> </ul>	The height and width of the overlay image in pixels must be divisible by 4.

### Overlay image limitations:

- The maximum overlay image size supported by the AXIS 241QA/AXIS 241SA is the same as the maximum image resolution. See the Technical Specifications, on page 66.
- When a text overlay is also used, this reduces the amount of space available to the overlay image. To keep the text readable at lower resolutions, the text overlay occupies proportionally more of the image at lower resolutions.
- If the overlay is initially positioned so that part of it is outside the video image, it is relocated so that it appears over the video image. It is always the entire image that is displayed.

Please see the online help  for more information.

## Use a Privacy Mask

To use privacy masks to hide different areas of the video image:

1. Select **Configurable areas as privacy mask** in the **Overlay/Mask Type** drop-down list.
2. Enter the (x,y) coordinates of the top left hand corner of the mask, and the height and width to define the masks' placement and size.
3. Select the color for the privacy mask - black, grey, white, or red.
4. Check the **Enable** box to enable the masks you have defined and click on **Save**.

The screenshot shows the configuration interface for the AXIS 241Q Video Server. The page title is "AXIS 241Q Video Server" with a "Live View | Setup | Help" link. The left sidebar contains a navigation menu with the following items: Basic Configuration, Video & Image (with sub-items: Image, Video Source, Overlay/Mask, and Advanced), Audio, Live View Config, PTZ Configuration, Event Configuration, System Options, and About. The main content area is titled "Overlay/Mask Settings" and includes a "Overlay/Mask Type" dropdown menu set to "Configurable areas as privacy mask". Below this is a section for "Privacy Mask Areas" with three entries: "Masking area 1:", "Masking area 2:", and "Masking area 3:". Each entry has an "Enable" checkbox and four input fields for "x:", "y:", "Width:", and "Height:", all currently set to "0". At the bottom of this section is a "Privacy mask color:" dropdown menu set to "Black". A note states: "Note: (x,y) = position of top left corner of privacy mask area. Max = 640x480". Below the note is a "Test Overlay/Mask Settings" section with a "Test" button. At the very bottom, there is a "Text after saving:" label and "Save" and "Reset" buttons.

# Audio

The AXIS 241QA/AXIS 241SA can transmit audio to other clients using an external microphone and can play audio received from other clients by attaching a speaker. The **Audio Settings** allow different audio configurations to be set up, such as full duplex, half duplex, and simplex.

**Note:** The speaker attached to the audio output of the AXIS 241QA/AXIS 241SA must have a built-in amplifier, which is the case for e.g. some PC speakers.

## Audio Settings

This section describes how to configure the basic audio settings for the AXIS 241QA/AXIS 241SA, such as setting the communication mode and adjusting the sound levels in the microphone and speaker connected to the camera.

The screenshot shows the 'AXIS 241QA Video Server' web interface. The top navigation bar includes 'Live View | Setup | Help'. The left sidebar contains a menu with 'Basic Configuration', 'Video & Image', 'Audio' (selected), 'Live View Config', 'Event Configuration', 'System Options', and 'About'. Under 'Audio', 'Basic' and 'Advanced' are listed. The main content area is titled 'Audio Settings' and contains the following configuration options:

- Enable Audio:** A checked checkbox labeled 'Enable audio'.
- Audio Channels:** 'Audio mode:' is set to 'Full duplex' via a dropdown menu. Below it is an unchecked checkbox labeled 'Send the sound from the active client to all other clients'.
- Audio Input:** 'Source:' is set to 'Line' via a dropdown menu. 'Input sensitivity:' is set to 'High' via a dropdown menu. Below is an unchecked checkbox labeled 'Enable microphone power. If your microphone is dynamic or battery powered, this should be off.' 'Input gain:' is set to '0' dB (0 = medium default level) via a dropdown menu. 'Encoding:' is set to 'G711 μ-law' via a dropdown menu. 'Bit rate:' is set to '64' kbits/s via a dropdown menu. 'Alarm level:' is set to '50' [%] [0..100] % via a text input field.
- Audio Output:** 'Output gain:' is set to '0' dB (0 = medium default level) via a dropdown menu.

At the bottom of the settings area, there is a note: 'Note: The Java applet only supports G711 audio. QuickTime supports G711.' and two buttons: 'Save' and 'Reset'.

### Enable Audio

Select the video sources that the AXIS 241QA/AXIS 241SA will transmit and receive audio from.

### Audio Channels

There are two mono audio channels between the AXIS 241QA/AXIS 241SA and a connected client, one for receiving audio and the other for transmitting audio. Each audio channel can be turned on or off, which means there are four **audio mode** options that can be used.



**Full-duplex** mode means that you can transmit and receive audio (talk and listen) at the same time, without having to use any of the controls. This is just like having a telephone conversation. The only controls you may wish to use are the mute buttons to turn off the sound, and the sliders, to adjust the input/output volume levels. This mode requires that the client PC has a sound card with support for full-duplex audio. If your available bandwidth is 0.2 Mbit/s or less, it is recommended that you use **Half-duplex** mode instead.

**Half-duplex** mode also transmits and receives audio in both directions, but only in one direction at a time. This means that you must select when to receive or transmit audio with the help of the push-to-talk button. To speak, press and hold the button (check that the microphone is not muted). When finished, release the button. You will now be receiving audio from the other end of the connection.

Note that the push-to-talk button is configured from AMC, see *AXIS Media Control (AMC)*, on page 14. It is also possible to configure the push-to-talk button so that it toggles between speaking and listening modes. Half-Duplex mode is best if you only have limited bandwidth available.

If you select the **Simplex - Video server speaker only** mode, the speaker connected to the AXIS 241QA/AXIS 241SA plays audio, but no audio is transmitted from the AXIS 241QA/AXIS 241SA to other web clients. This could be used to provide spoken instructions to a person seen in a camera. This mode requires you to use the push-to-talk button.

The **Simplex - Video server microphone only** mode transmits audio from the AXIS 241QA/AXIS 241SA to a web client. It does not receive audio from any other web client. This can be used in remote monitoring, and web attractions, to provide live audio and video of a monitored situation.

When using half-duplex, the **Send the sound from the active client to all other clients** option transmits the audio signal from the client talking to all the other clients.

### Audio Input

Audio from an external microphone or a line source can be connected to the Line/Microphone In jack of the AXIS 241QA/AXIS 241SA. The audio source can be set to **Microphone** or **Line**. If you are using a microphone, the **Input sensitivity** can be set to **High** or **Low**. See *Technical specifications*, on page 66 for the exact maximum levels.

The **Enable microphone power** option provides DC power for the external microphone. If you use a small electret condenser microphone such as a clip-on microphone or a PC microphone, this option needs to be enabled.

To use a high impedance dynamic microphone, DC power should not be enabled. DC power will not harm the microphone, but if you are uncertain, try switching it off and on. DC power is enabled by default. To use a professional microphone requiring 48V phantom power, you need an external power supply and must use a balanced-unbalanced converter (audio transformer) in between.



If the sound input is too low or high, it is possible to adjust the **input gain** for the microphone attached to the AXIS 241QA/AXIS 241SA.

Select the desired audio **Encoding** format, G711, G726.

Depending on the selected encoding, set the desired **Bit rate** (audio quality). The settings depend on the available bandwidth and the required audio quality, that is, a high bit rate setting requires more bandwidth.

### Audio Output

If the sound from the speaker is too low or high it is possible to adjust the **output gain** for the active speaker attached to the AXIS 241QA/AXIS 241SA.

When satisfied with the settings, click **Save**, or click **Reset** to revert to the previously saved settings.

### Advanced Audio Settings

The **Audio Quality Settings** allow you to tune the audio input to suit your environment.

The screenshot displays the 'Advanced Audio' configuration page for the AXIS 241QA Video Server. The interface includes a sidebar with navigation links: Basic Configuration, Video & Image, Audio (with 'Advanced' selected), Live View Config, Event Configuration, System Options, and About. The main panel is titled 'Advanced Audio' and features a 'Audio Quality Settings' section. This section contains two checked checkboxes: 'Enable speech filter' and 'Enable echo cancellation'. Below these are two adjustable parameters: 'Noise canceller threshold value' is set to 'Low' via a dropdown menu, and 'Noise canceller attenuation' is set to '0' dB via another dropdown menu. At the bottom of the settings area are 'Save' and 'Reset' buttons.

**Enable speech filter** improves the sound quality if using a microphone that is placed close to the person talking and can also help reduce background noise. The filter cuts the lowest and the highest frequencies. The bypass frequency range is approximately 250Hz to 3700Hz (measured at -10dB cut-off points).

**Enable echo cancellation** can reduce the feedback generated when using full duplex. If there is sound distortion, turning echo cancellation off may improve the sound quality.

Noise cancelling is a way of reducing the background noise when there is no useful audio present. A typical application could be when there is a noisy environment and you are only interested in hearing the sound when someone is speaking close to a microphone. There are two adjustable parameters available to optimize this function:

- Noise canceller threshold value
- Noise canceller attenuation

When the incoming sound is louder than the threshold, it will pass without any change. When lower than the threshold, the incoming sound is reduced by a certain attenuation factor. The threshold value should be set higher than the background noise, but lower than the useful audio.

The **noise canceller threshold value** can be set to **High, Medium High, Medium low** and **Low**. A lower threshold will allow most of the audio to pass. Only the weakest background noise is reduced. A higher threshold makes the noise canceller act on even stronger background noise. At the maximum level **High**, there is a risk of reducing useful audio as well.

There is a trade-off between noise cancelling and sound quality. In other words, increasing the **Noise canceller attenuation** value compromises sound quality. Adjust the threshold and the attenuation to an optimum level by listening and changing the levels.

# Live View Config

## Layout

These are the tools for deciding the layout of the Live View page.

The layout can be set in two ways:

- Use Axis look - the layout is unchanged.
- Use custom settings - modify the default page with your own colors, and images. Click the **Configure** button to view the options.

The other settings on this page relate to buttons and links to include in the Live View page. See page 30 for more information.

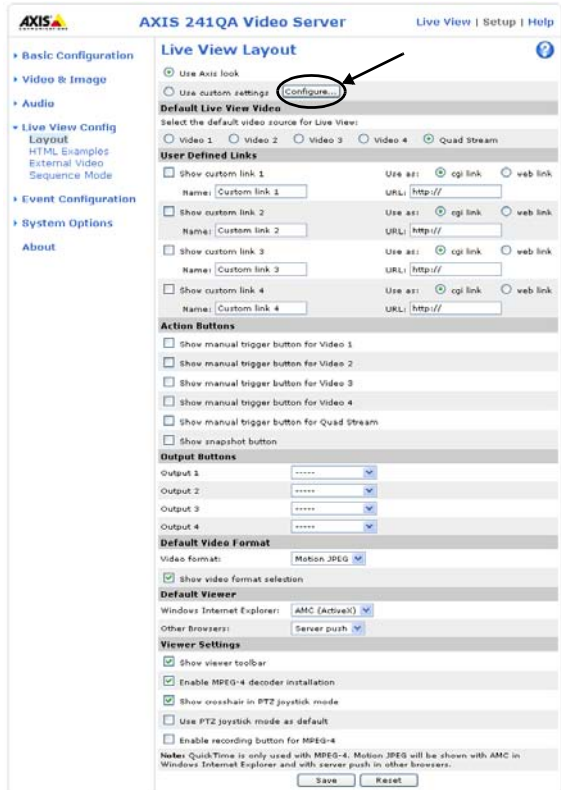

## Customizing the default page

The appearance of the default AXIS 241QA/AXIS 241SA Live View page can be customized to suit your own requirements, or you can upload and use your own home page. To upload your own files, click the Upload/Remove button and see the description below.

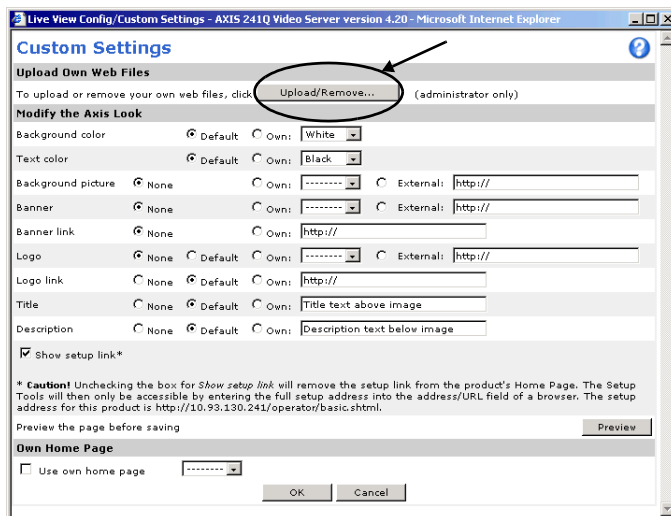

Note that the setup address is `http://<ip address>/operator/basic.shtml`

## Upload Own Web Files

Your own web files, and background pictures must first be uploaded to the AXIS 241QA/AXIS 241SA before they are available for selection in the Custom Settings page.

1. In the Upload/Remove Own Web files page, enter the path to the file, or click the **Browse** button.
2. Select the user level for the uploaded file. Setting the user access level means that you have complete control over the pages can be viewed by users.
3. When the path is shown correctly in the text field, click the **Upload** button. Uploaded files are now shown in the list in the lower section of the page.

**Note:** To remove a file, check the relevant box under Remove Uploaded Files and click the Remove button.

4. To use your uploaded file, click on the radio button and select the file from the drop-down list.

To use an external file located somewhere other than in the AXIS 241QA/AXIS 241SA, select the **External** radio button and enter the URL in the field marked **External**.

### Modify the Axis Look

Select the background and text colors from the drop-down lists. To add a background picture, a banner and/or a logo, select your uploaded file or specify the location of an external file as described above. Banners and logos can also be linked to web addresses. Include a title to be shown above the video stream and/or a description displayed below the video stream.

### Own Home Page

To use a previously uploaded web page as the default page, check the **Own Home Page** box, select the page from the drop-down list and click OK.

### Default Live View Video

Select a single video source or the quad view to use as the default view on the Live View page.

### Default Video Format

Select the default video format to use on the Live View page. Check the box against **Show video format selection** to view the drop-down list on the Live View page. Here you can temporarily change the format.

### Default Viewer

Select from the drop-down list the viewer you wish to use for your web browser. Please see the online help for more information.

### Viewer Settings

**Show viewer toolbar** - enables display of the viewer's own toolbar under the image.

**Enable MPEG-4 decoder installation** - the administrator can enable or disable the installation of the MPEG-4 decoder included with AMC. This is used to prevent the installation of unlicensed copies. Further decoder licenses can be purchased from your Axis dealer.

**Show crosshair in PTZ joystick mode** - this enables the display of a crosshair in the video image when the PTZ mode is set to joystick.

**Use PTZ joystick mode as default** - sets the PTZ joystick mode as the default mode.

**Enable recording button** - allows the user to start an MPEG-4 recording directly from the Live View page.

### Action Buttons

The manual trigger buttons can be used to manually start and stop an event from the Live View page. See *Pan Tilt Zoom*, on page 32. The **Show snapshot** option allows you to take a snapshot of the video stream and save it to a computer.

## User-defined Links

Enter a descriptive name and the URL in the field provided. The link appears on the Live View page.

User defined CGI links can be used to issue HTTP API requests, such as PTZ commands. Example:

1. Check **Show Custom Link 1**
2. Enter a descriptive name, such as CAM1 Start PTZ.
3. Enter the cgi link:  
`http://192.168.0.125/axis-cgi/com/ptz.cgi?camera=1&continuouspaniltmove=30,-30`
4. Check **Show Custom Link 2**.
5. Enter a descriptive name, such as CAM1 Stop PTZ.
6. Enter the cgi link:  
`http://192.168.0.125/axis-cgi/com/ptz.cgi?camera=1&continuouspaniltmove=0,0`

These links appear in the web interface and can be used to control the PTZ camera.

For more information on VAPIX® AXIS Communication's powerful API, see the Developer pages at the Axis web site [www.axis.com/developer](http://www.axis.com/developer)

See also the section on PTZ, on page 37.

## HTML Examples

Live video from the Axis video server can be added to your own web page.

Select the preferred video format from the **Select video format** drop down list. The available options are Motion JPEG, MPEG-4 using AMC, and MPEG-4 using QuickTime. If MPEG-4 using AMC is set as the video format, note that a separate MPEG-4 license is required for each viewer.

The Motion JPEG selection has additional settings for **Image Type**, **Image size** and **Optional settings** for configuring the video stream to suit your web page. Click **Update** when satisfied.

The video server then generates the required source code for your configuration. Copy this code and paste it into your own web page code.

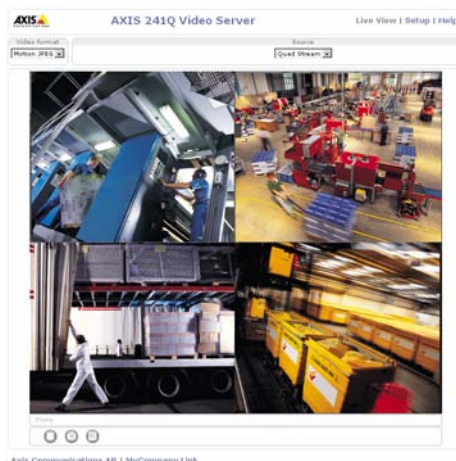

## External Video

You can add links to other Axis network devices available over the network. These sources can be displayed on the Live View page, just as if they were video sources connected directly to the AXIS 241QA/AXIS 241SA.

Click the **Add...** button to open the **External Video Source Setup** dialog, and define the necessary settings.

Example of a path to an external video source:

```
http://192.168.0.125/axis-cgi/mjpeg/video.cgi
```

## Sequence Mode

The live view page can be configured to rotate through selected internal and/or external video sources, in order or at random. PTZ preset positions can also be included.

Select the desired video sources and enter the time in seconds to display each source (up to 59 minutes). Click **Save**.

The Sequence buttons appear in the Live View page to allow the viewer to start and stop the sequence mode.



Please see the online help  for more information.

## Pan Tilt Zoom

### Installing PTZ devices

The AXIS 241QA/AXIS 241SA supports several PTZ devices. Please see [www.axis.com](http://www.axis.com) for a complete list of supported devices, and to obtain the correct driver. Follow the instructions below to install a PTZ device:

1. Using an appropriate cable, connect the device to your selected port (RS-232 or RS-485). These ports are available via the D-Sub connector and the I/O terminal connector, respectively. See pages 57 and 59 for more information.
2. In the menu in your web page, go to **Setup > System Options > Ports & Devices** and then select either port RS-232 or RS-485 to configure. See the figure below.

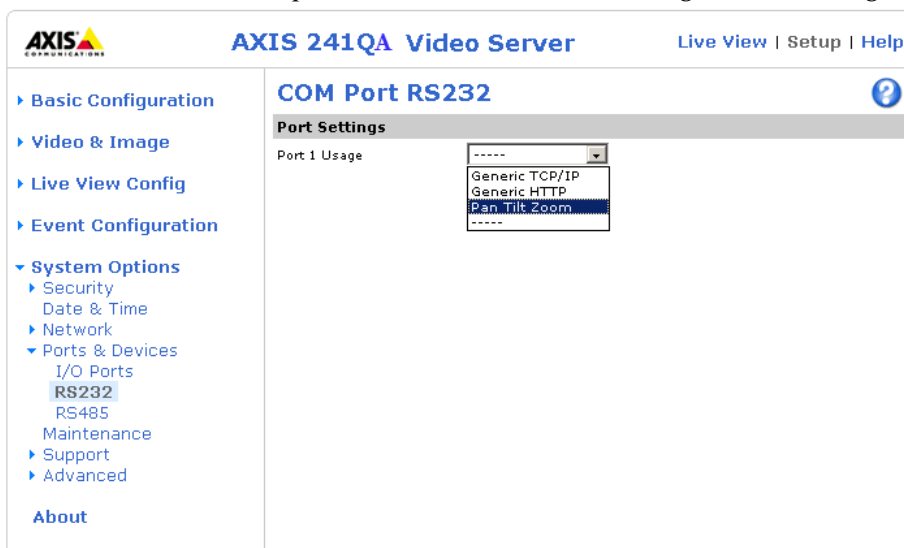

3. Select **Pan Tilt Zoom** from the Usage drop-down list.
4. Click **Upload** to install a PTZ driver.  
(PTZ drivers are available from the Axis Web site at [www.axis.com](http://www.axis.com))
5. Click **Port Options...** to modify the port settings. The default values correspond to the values specified by the PTZ driver.
6. From **System Options > Ports & Devices**, select the port configured for PTZ and then select the video source to use with the device.
7. If required, click the **Advanced Options** button to make further settings and see the online help. 

**Note:** Advanced users and application developers can also use the Axis Application Programming Interface and HTTP specification for generic control of PTZ devices using CGI commands or a TCP/IP client. Please refer to the Axis Website at [www.axis.com](http://www.axis.com) for further information.



## PTZ configuration

Once PTZ has been installed for the AXIS 241QA/AXIS 241SA, PTZ Configuration now appears in the menu to the left with the following sub menus.

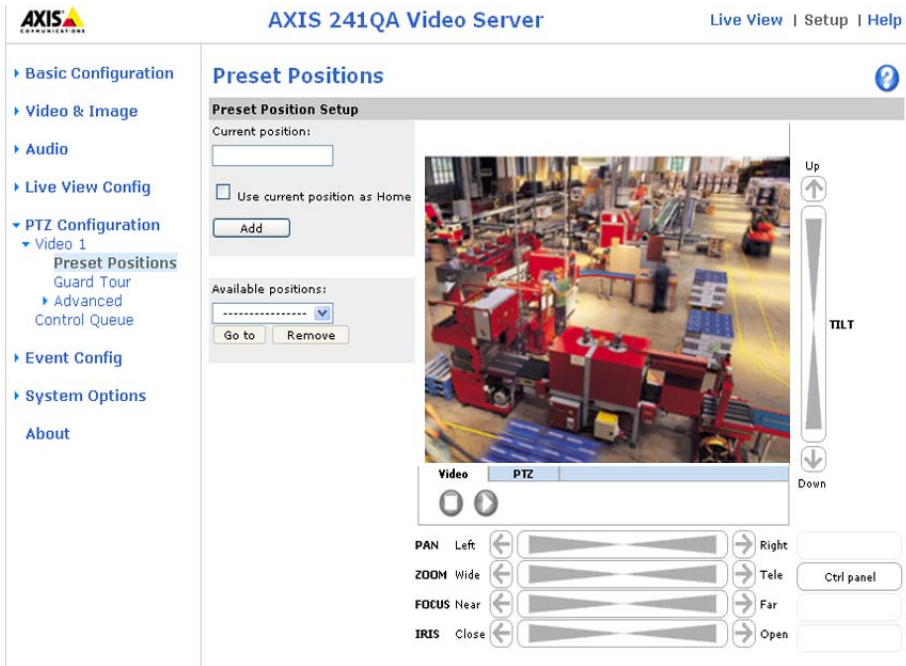

## Preset positions

A preset position is a pre-defined camera view that can be used to quickly move the camera to a specific location.

From **Preset Position Setup**, use the Pan, Tilt and Zoom (PTZ) controls to steer the camera to the required position. When satisfied with the camera's position, enter a descriptive name. The camera position, iris and focus settings are then saved as a preset position.

The position can be assumed at any time, by selecting the preset's name from the Preset positions drop-down list. Preset positions can be selected in **Live View**, from events and in **Sequence mode**.

One position can be set as the **Home** position, which is readily accessible by clicking the box beside **Use current position as Home**. The position's name will then have (H) added to the end, such as Office Entrance (H).

## PTZ controls

If the AXIS 241QA/AXIS 241SA has been appropriately configured, the Live View page will display the controls available for the installed PTZ device. The administrator can enable/disable the controls for specified users.

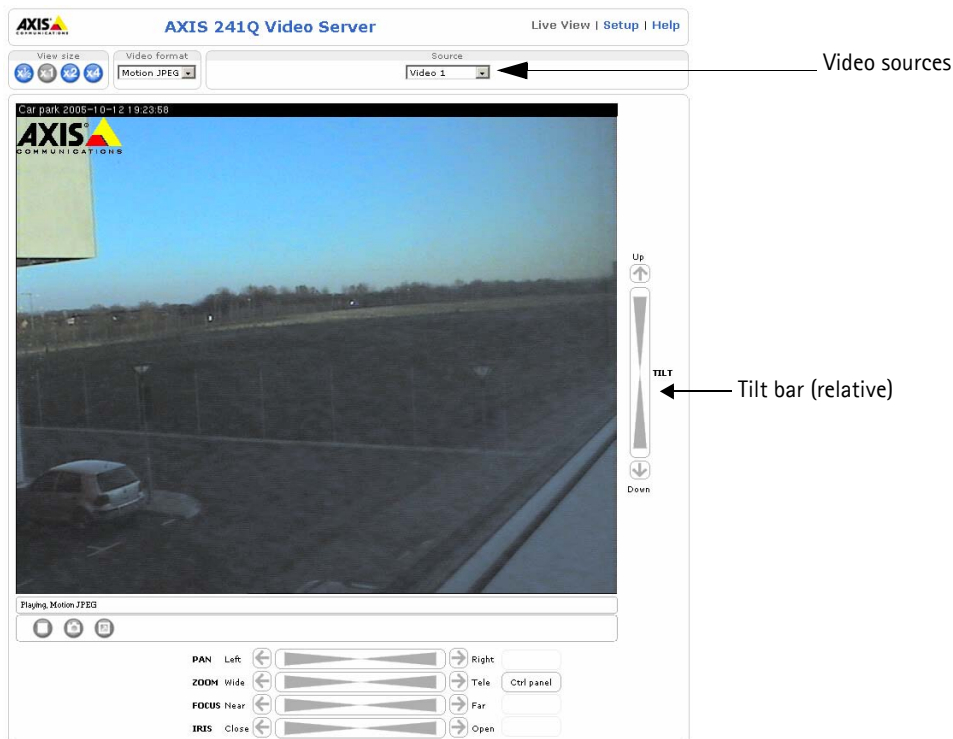

The exact controls shown depend on the make and model of PTZ device. There may be Focus and Iris bars available as well, but the most common controls are:

- the Pan bar - moves the camera to the right and left
- the Tilt bar - tips the camera up and down
- the Zoom bar - zooms the view in and out. Note that this is only available if the camera is fitted with a zoom lens.

Clicking on the bars or on the arrows at the end of the bars will move the camera to a new position. The type of movement and the location of this new position depends on the type of PTZ driver.

When controlling the camera using a **relative** PTZ driver (see the bars in the illustration above) the new position is relative to the previous position, for example, left of, below, above. Clicking the bar further from the center results in a larger movement.

In contrast, when using an **absolute driver**, each position on the bar (see right) represents a defined position in the device’s range of movement, with the center of the bar representing the point midway between the two extremes of movement.



Clicking a position directly on the bar moves the camera directly to the new position in one smooth movement. Clicking on the arrows at the ends of a bar causes a stepped, incremental change.

### Using CGI links to control PTZ devices

User-defined CGI links on the Live View page can be used to issue HTTP API requests, such as PTZ commands. These links are configured in the Live View Layout settings; see page 9.

### PTZ control modes

The PTZ device can also be controlled using **click-in-image** movement, which has two different types of navigation; **Center** and **Joystick**.

**Center** mode means that when clicking in the image, the camera view centers on the absolute position that was clicked.

**Joystick** mode moves the camera in the direction of the mouse pointer. By clicking and holding the mouse button down in the image, the PTZ device moves the camera in that direction, relative to the center of the image. The further from the center the image is clicked, the greater the movement. The camera stops moving when the button is released.

**Note:** There is also joystick support in AXIS Media Control (AMC).

### Control panel

The focus and iris (image brightness) can be adjusted manually by using the control bars, or they can be set for automatic adjustment, by clicking the **Auto iris** and **Auto focus** buttons.

To access the **Auto iris** and **Auto focus** buttons, click on the **Control panel** button. The menu to the right will then appear in the upper left hand corner of the screen.

There are also driver specific shortcuts that can appear in the Control Panel. In the screen to the right, a driver has been installed that brings up the **Wiper** shortcut button, which allows the user to configure and use a windshield wiping action with the AXIS 241QA/AXIS 241SA.



## Preset positions

Also available with many PTZ devices are **Preset positions**. These presets are selected from the drop-down **Source** list on the **Live View** page and will move and/or zoom the camera to a pre-defined position, that is to cover an area of particular interest. Events can also be configured to go to preset positions when triggered. For information on setting up preset positions, please see *Preset positions*, on page 33 and the online help.

## Guard tour

A guard tour moves between chosen **Preset Positions**, one-by-one, in a pre-determined order or at random, and for configurable time periods. Unlike the **Sequence Mode**, which is a viewing application under **Live View Config** (see *Live View Config*, on page 27), the guard tour sequence runs after the user has logged off or closed the browser.

The screenshot displays the web interface for the AXIS 241QA Video Server. The main content area is titled "Guard Tour" and contains a "Guard Tour List" table. The table has three columns: "Name", "Running", and "Mode". Below the table, there are four buttons: "Add...", "Modify...", "Start/Stop", and "Remove". A note at the bottom of the table area reads: "Note: To schedule a Guard Tour, add a scheduled event from the [Event page](#)." The left sidebar shows a navigation menu with "Guard Tour" selected under the "PTZ Configuration" section.

## Advanced

**Device** - The **Device Settings** window is for driver specific settings. The appearance of this window can vary depending on the driver installed. Options that can be configured include: **Driver Specific Settings for Video Source 1**, **Mechanical Limits for Moving Video Source 1**, **Light Control for Video Source 1**, and **Extended Driver Specific Settings for Video Source 1**.

**Controls** - The **Control** settings window contains tools for creating and saving short command buttons that are located under the **Control panel**. These buttons provide direct access to various built-in auxiliary commands provided by the PTZ driver and are displayed in the PTZ Panel.

**OSD Menu** - If the PTZ unit supports an internal configuration menu, this can be accessed using the On-Screen Display (OSD). Configure the analog camera by opening and navigating through its internal menu in this display.

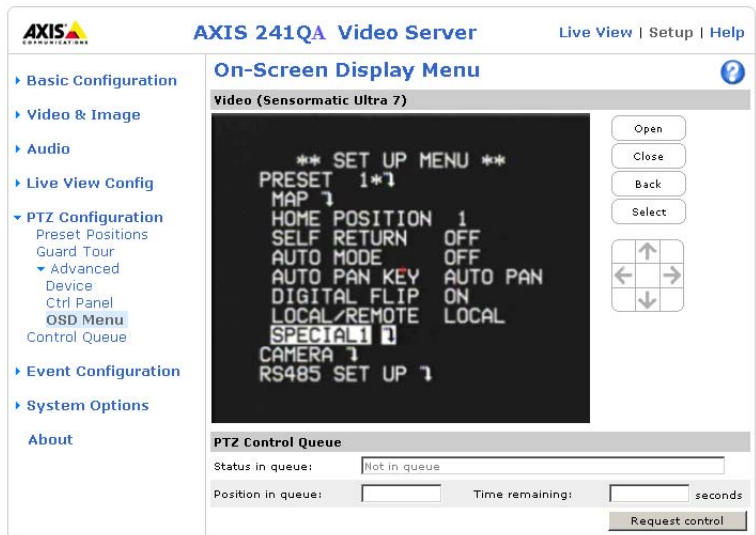

## PTZ control queue

Use the PTZ control queue window to enable and disable PTZ queuing. This window allows you to set up a queue for viewers wanting to access the AXIS 241QA/AXIS 241SA, and limits the number of viewers and the length of time each viewer can access and control the PTZ unit. For more information on how to set up the control queue, please see the online help. [?](#)

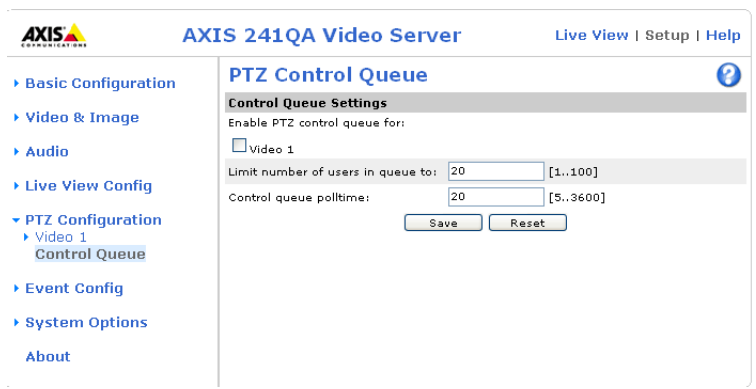

Note also that a viewer who belongs to a group (see *Security*, on page 45) with a higher PTZ priority can go before other users in the queue and take control of the AXIS 241QA/AXIS 241SA.

The order of priority for taking control of the queue is as follows:

1. **Administrators** - an administrator takes over PTZ control regardless of who is first in queue. The administrator is removed from the queue 60 seconds after their last PTZ control command.
2. **Event** - the AXIS 241QA/AXIS 241SA can be set up to take control of the queue and move to a specific position for 20 seconds when triggered by an alarm. The event is immediately placed first in the queue, except when an administrator is in control. For more information, see *Triggered Event*, on page 40.
3. **Operator** - same as administrator, but with lower priority.
4. **Guard tour** - a guard tour has PTZ control for an indefinite period of time. It may be overridden by Operator, Event, or administrator. Guard tour resumes when higher priority groups leave the queue. For more information see *Guard tour*, on page 36.
5. **Viewer** - Multiple viewers must await their turn. The viewer has 60 seconds PTZ control before control is passed to the next viewer in queue.

**Note:** In order to identify different users in the viewer group, cookies must be enabled on the client.

## Event configuration

This section describes how to configure the AXIS 241QA/AXIS 241SA for alarm handling. Various actions can be configured to run when certain types of events occur.

Event type	A set of parameters describing how and when the video server is to perform certain actions	
Triggered Event (see page 40)	the circumstances that start an event	at a signal from an external device, such as a door switch or a motion sensor
Scheduled Event (see page 41)	the circumstances that start an event	at a pre-programmed time
Action	what occurs when the event runs	video images uploaded to an FTP server, email notification sent.

## Event servers

Event Servers are used for receiving uploaded image files and/or notification messages. To set up an Event server for your AXIS 241QA/AXIS 241SA, click on **Event Servers** under **Event Config** and enter the required information according to the selected server type.

Server type	Purpose	Information required
FTP Server	<ul style="list-style-type: none"> <li>receives uploaded images</li> </ul>	<ul style="list-style-type: none"> <li>Descriptive name of your choice</li> <li>User Name and Password</li> <li>Upload path, (e.g. images/)</li> <li>Port number</li> <li>Use passive mode if there is a firewall between the video server and FTP server</li> <li>Use a temporary file if your FTP server does not allow an existing file to be overwritten by a new file with the same name.</li> </ul>
HTTP Server	<ul style="list-style-type: none"> <li>receives notification messages</li> <li>receives uploaded images</li> </ul>	<ul style="list-style-type: none"> <li>Descriptive name of your choice</li> <li>URL</li> <li>User Name and Password</li> <li>Proxy address/Proxy port (if required)</li> <li>Proxy User Name and Password (if required)</li> </ul>
TCP Server	<ul style="list-style-type: none"> <li>receives notification messages</li> </ul>	<ul style="list-style-type: none"> <li>Descriptive name of your choice</li> <li>Port number</li> </ul>

For details on each setting, please refer to the online help  available from each web page.

**Note:** The images in pre-trigger and post-trigger buffers will be lost if the connection to the event server fails.

When the setup is complete, the connection can be tested by clicking the **Test** button (the test takes approximately 10 seconds).

## Event types

An event type is a set of parameters describing how and when the video server is to perform certain actions.

**Example:** If somebody walks past the connected camera, and an event has been configured to act on this, the video server can record and send video images to an FTP server, or send a notification email to a pre-configured email address with a pre-configured message. Video images can be sent as an attachment with the email.

**AXIS 241QA Video Server** Live View | Setup | Help

**Event Types**

Event Type List

Name	Status	Enabl.	Priority	Trig./Sched.	Actions*

\* Fu=FTP upload, Hu=HTTP upload, Eu=Email upload, O=Output port, En=Email notification, Hn=HTTP notification, Tn=TCP notification, P=PTZ preset, G=Guard Tour

## Triggered Event

A triggered event could be activated by:

- a push button connected to an input port on the video server
- detected movement in a configured motion detection window
- a lost signal from a video source
- a manual action clicking the trigger button in the web interface
- on restart (reboot) after power loss

## How to set up a triggered event

This example describes how to set the AXIS 241QA/AXIS 241SA to upload images when the main door is opened:

1. Click **Add triggered** on the Event types page.
2. Enter a descriptive **Name** for the event, such as Main door.
3. Set the **priority** - High, Normal or Low (see online help files).
4. Select the **video Source** the event is to act on - Video 1 on Main door.
5. Set the **Respond to Trigger...** parameters defining when the event is to be active; e.g. only after office hours
6. Select the trigger alternative from the **Triggered by...** drop-down list; e.g. an Input port with a connected sensor if the door is opened.
7. Set the **When Triggered...** parameters, that is what the video server should do if the main door is opened - e.g. upload images to an FTP server.
8. Click **OK** to save the event in the Event Types list.

Please see the online help  for descriptions of each available option.



### Pre-trigger and post-trigger buffers

This function is useful when checking to see what happened immediately before and after a trigger, e.g. two minutes before and after a door was opened. Check the **Upload images** option under **Event Types > Add Triggered... > When triggered...** to see available options.

**Include pre-trigger buffer** - images stored internally in the server from the time immediately preceding the trigger. Check the box to enable the pre-trigger buffer, enter the desired length of time, and specify the required image frequency.

**Include post-trigger buffer** - contains images from the time immediately after the trigger. Configure as for pre-trigger.

**Note:** If the pre- or post-buffer is too large for the Axis video server's internal memory, the frame rate is reduced and individual images may be missing. If this occurs, an entry will be created in the unit's log file.

**Continue image upload (unbuffered)** - enables the upload of images for a fixed length of time. Specify the time for the uploaded recording in seconds, minutes or hours, or for as long as the trigger is active. Finally, set the desired image frequency to the maximum (the maximum possible) or to a specified frame rate. The frame rate would be the best possible, but might not be as high as specified, especially if uploading via a slow connection.

### Scheduled event

A **Scheduled event** can be activated at pre-set times, in a repeating pattern on selected weekdays.

#### How to set up a scheduled event

This example describes how to set the video server to send an email notification with saved images from a set time:

1. Click **Add scheduled** on the **Event types** page.
2. In the **Scheduled Event Type Setup** page, enter a descriptive **name** for the event, such as **Scheduled email**.
3. Set the **priority** (High, Normal or Low).
4. Select the **video source** that is the source the event should act on; e.g. **Video 2 in Storage room**.
5. Set the **Activation Time** parameters (24h clock) when the event should be active; e.g. **start on Sundays at 13.00 with a duration of 12 hours**.
6. Set the **When Activated...** parameters that is what the video server should do at the specified time; such as **send uploaded images to an email address**.
7. Click **OK** to save the Event in the **Event Types** list.

Please see the online help  for descriptions of each available option.

## Camera tampering

The camera tampering application generates an alarm whenever the camera is repositioned, or when the lens is covered, sprayed, or severely defocused.

You must also create an event, (see *How to set up a triggered event*, on page 40) for the camera to send an alarm.

The screenshot shows the 'AXIS 241QA Video Server' web interface. The top navigation bar includes 'Live View | Setup | Help'. The left sidebar contains a menu with the following items: Basic Configuration, Video & Image, Audio, Live View Config, PTZ Configuration, Event Config (with sub-items: Instructions, Event Servers, Event Types, Camera Tampering, Motion Detection, Port Status), System Options, and About. The 'Camera Tampering' section is selected and highlighted.

The main content area is titled 'Camera Tampering' and contains four sections, one for each video stream (Video 1 to Video 4). Each section has a 'Minimum duration' field set to '20' with a 'seconds' dropdown menu, and a checkbox labeled 'Alarm for dark images.' which is checked. At the bottom of the configuration area are 'Save' and 'Reset' buttons.

### Settings

The Minimum duration parameter sets the minimum tampering period, that is an alarm will not be triggered until this period has lapsed, even if the tampering conditions are otherwise met. This can help prevent false alarms for known conditions that affect the image.

If the camera lens is sprayed or covered so that the camera's live view becomes dark, it will not be possible to distinguish this situation from other situations where the same effect is seen, such as when lighting conditions change.

When the Alarm for dark images parameter is enabled, alarms are generated for all cases where the lights are either dimmed or turned off, or if the lens is sprayed, covered, or severely defocused. If not enabled, no alarm is sent.

After you define these settings, click Save.

## Motion detection

In the Motion Detection menu, you can configure the video source(s) for motion detection. The motion detection feature is used to generate an alarm whenever movement occurs (or stops) in the image. The AXIS 241QA/AXIS 241SA can use a maximum of 10 Include/Exclude windows.

- **Include** windows target specific areas within the image
- **Exclude** windows are areas to be ignored within the Include window

Once configured, the motion detection windows will appear in a list when motion detection is selected to trigger an event. See *How to set up a triggered event* above.

**Note:** Using the motion detection feature may decrease overall performance in the video server.



### How to configure Motion Detection

This example describes how to configure motion detection:

1. Click Motion Detection in the Event Config menu.
2. Click New against Windows Name.
3. Select the **Include** or **Exclude** option to define an Include or Exclude window, and enter a descriptive name in the field below.
4. Click Save.
5. Adjust the size (drag the bottom right-hand corner) and position (click on the text at the top and drag to the desired position).
6. Adjust the **Object Size**, **History** and **Sensitivity** profile sliders (see table below for

7. details). Any detected motion within an active window is then indicated by red peaks in the Activity window (the active window has a red frame).
8. Click **Save**.

If there are parts of the Include window that you wish to exclude, click the **Configure Excluded Windows** radio button and perform steps 1-6 above. Click **Save**.

Please use the online help  for descriptions of each available option.

Parameter	Object Size	History	Sensitivity
High	Only very large objects trigger motion detection	An object that appears in the region will trigger the motion detection for a long period	Ordinary colored objects against ordinary backgrounds will trigger the motion detection
Low	Even very small objects trigger motion detection	An object that appears in the region will trigger motion detection for only a very short period	Only very bright objects against a dark background will trigger motion detection
Default values	Low	Medium to High	Medium to High

### Examples:

- Avoid triggering on small objects in the image by selecting a high size level.
- To trigger motion detection as long as there is activity in the area, select a high history level.
- To only detect flashing light, low sensitivity can be selected. In other cases, a high sensitivity level is recommended.

### Port status

Under **Event Configuration > Port Status**, there is a list that shows the status for the connected inputs and outputs of the AXIS 241QA/AXIS 241SA. This is for the benefit of an operator, who cannot access the System Options section.

**Example:** If the Normal state for a push button connected to an input is set to Open circuit, as long as the button is not pushed, the state is inactive. If the button is pushed, the state of the input changes to active.

# System options

---

## Security

User access control is enabled by default, when the administrator sets the root password on first access. New users are authorized with user names and passwords, or the administrator can choose to allow anonymous viewer login to the Live View page, as described below:

### Users

The user list displays the authorized users and access levels:

Viewer	Provides the lowest level of access, which only allows the user access to the Live View page
Operator	An Operator can view the Live View page, create and modify event types and adjust certain other settings. The Operator does not have access to the Systems Options configuration pages.
Administrator	An administrator has unrestricted access to the Setup Tools and can determine the registration of all other users.

To prevent unauthorized use of the product, the AXIS 241QA/AXIS 241SA network camera supports multi-user password protection, where access can be restricted to a defined number of users only (maximum of 20).

The AXIS 241QA/AXIS 241SA Network Camera supports several methods of user authentication. These are:

- **HTTP Basic Authentication** - This authenticates the user by requesting a user name and a password. The exchange of network credentials is in simple base64 coding and is not encrypted.
- **HTTP Digest Authentication** - This method also requests a user name and password, but the exchange of credentials is encrypted, which better secures it against eavesdropping.

User settings - check the corresponding checkboxes to enable:

- **Anonymous viewer login** - allows viewers direct access to the Live View page.
- **Anonymous PTZ control login** - allows any viewer access to the Pan Tilt Zoom controls on the Live View page (if Pan/Tilt/Zoom is available).

### IP Address Filter

Checking the **Enable IP address filtering** box enables the IP address filtering function. Up to 256 IP address entries may be specified (a single entry can contain multiple IP addresses). Click the **Add** button to add new filtered addresses.

When the IP address filter is enabled, addresses added to the list are set as allowed or denied addresses. If the addresses in the list are allowed, then all others are denied access, and vice versa. See also the online help  for more information.

Note that users from IP addresses that will be allowed must also be registered with the appropriate access rights (**User**, **Operator** or **Administrator**). This is done from **Setup > System Options > Security > Users**.

**Referrals** - to prevent unauthorized sources from including the video stream from the AXIS 241QA/AXIS 241SA into external Web pages, check the **Referrals** box and enter the IP address or Host name of the computer that hosts the Web pages with the included video stream. Multiple IP addresses/host names can be defined and are separated by semicolons(;

- Notes:**
- If the referrals feature is enabled and you wish to also allow normal access to the Live View page, the product's own IP address or host name must be added to the list of allowed referrers.
  - Restricting referrers has no effect on an MPEG-4 video stream. To restrict an MPEG-4 stream, IP address filtering must be enabled.
  - Restricting referrers is of greatest value when not using IP address filtering. If IP address filtering is used, then the allowed referrers are automatically restricted to those allowed IP addresses.

## HTTPS

For greater security, the AXIS 241QA/AXIS 241SA can be configured to use HTTPS (Hypertext Transfer Protocol over SSL (Secure Socket Layer)). That is, all communication that would otherwise go via HTTP will instead go via an encrypted HTTPS connection.

To use HTTPS for communication with the AXIS 241QA/AXIS 241SA, a certificate must be created using one of these methods:

- A self-signed certificate can be created in the video server, but this does not guarantee the same level of security as an official certificate.
- An official certificate issued by a CA (Certificate Authority). A CA issues and manages security credentials and public keys for message encryption.

To create a self-signed certificate:

1. Click either **Create self-signed certificate** or **Create Certificate Request** and enter the required information in the provided fields
2. Click **OK**.
3. The **Create self-signed certificate...** option generates and installs a certificate which is displayed under **Installed Certificate**.  
The **Create Certificate Request** option generates a PEM formatted request which you copy and send to a CA for signing. When the signed certificate is returned, click **Install signed certificate...** to install the certificate in the AXIS 241QA/AXIS 241SA.
4. Set the **HTTPS Connection Policy** for the administrator, Operator and Viewer to enable HTTPS connection (set to HTTP by default)

Please refer to the home page of your preferred CA for information on where to send the request. For more information, please see the online help 

## IEEE 802.1X

IEEE 802.1x is an IEEE standard for port-based Network Admission Control. It provides authentication to devices attached to a network port (wired or wireless), establishing a point-to-point connection, or if authentication fails, preventing access on that port. 802.1x is based on EAP (Extensible Authentication Protocol).

In a 802.1x enabled network switch, clients equipped with the correct software can be authenticated and allowed or denied network access at the Ethernet level.

Clients and servers in an 802.1x network may need to authenticate each other by some means. In the Axis implementation this is done with the help of digital certificates provided by a Certification Authority. These are then validated by a third-party entity, such as a RADIUS server, examples of which are Free Radius and Microsoft Internet Authentication Service.

To perform the authentication, the RADIUS server uses various EAP methods/protocols, of which there are many. The one used in the Axis implementation is EAP-TLS (EAP-Transport Layer Security).

The AXIS network video device presents its certificate to the network switch, which in turn forwards this to the RADIUS server. The RADIUS server validates or rejects the certificate and responds to the switch, and sends its own certificate to the client for validation. The switch then allows or denies network access accordingly, on a preconfigured port.

## RADIUS

RADIUS (Remote Authentication Dial In User Service) is an AAA (Authentication, Authorization and Accounting) protocol for applications such as network access or IP mobility. It is intended to work in both local and roaming situations.

## CA servers

In cryptography, a Certification Authority (CA) is an entity that provides signed digital certificates for use by other parties, and thus acts a trusted third party.

There are many commercial CAs that charge for their services. Institutions and governments may have their own CA, and there are free CAs available.

## Date & time

**Current server time** - displays the current date and time (24h clock). The time can be displayed in 12h clock format in overlay images.

**New server time** - select your **Time Zone** from the drop-down list and check the daylight saving time changes, if you want.



From the **Time Mode** section, select the preferred method to use for setting the time:

- **Synchronize with computer time** - sets the time from the clock on your computer.
- **Synchronize with NTP server** - the video server obtains the time from an NTP server every 60 minutes. Specify the NTP server's IP address or host name.

**Note:** Note that if using a host name for the NTP server, a DNS server must be configured under TCP/IP settings. See **Network > Advanced TCP/IP Settings** below.

- **Set manually** - this option allows you to manually set the time and date.

**Date & Time Format Used in Images** - specify the formats for the date and time (12h or 24h) displayed in the Live View video streams.

Use the predefined formats or use your own custom date and time formats. See **File Naming & Date/Time Formats** in the online help  for information on how to create your own date and time formats.

## Network - Basic TCP/IP settings

### IP Address Configuration

Your Axis network camera supports both IP version 4 and IP version 6. Both versions may be enabled simultaneously, and at least one version must always be enabled.

When using IPv4, the IP address can be set automatically via DHCP, or a static IP address can be set manually.

If IPv6 is enabled, your camera will receive an IP address according to the configuration in the network router.

There are also options for setting up notification of changes in the IP address, and for using the AXIS Internet Dynamic DNS Service. For more information on setting the IP address, please see the online help.

- Notes:**
- DHCP is a protocol for automatic IP address assignment on a network. IP address assignment via DHCP may lead to the situation where the IP address changes and you lose contact with the camera. Configure the options for notification of IP address change (under **Services**) to receive notification from the camera when the IP address changes.
  - Alternatively, if your DHCP server can update a DNS server, you can access the AXIS 241QA/AXIS 241SA by host name which is always the same, regardless of the IP address.

### Services

**Enable ARP/Ping setting of IP Address** - The IP address can be set using the ARP/Ping method, which associates the unit's MAC address with an IP address. Check this box to enable the service. Leave disabled to prevent unintentional resetting of the IP address.

- Notes:**
- The ARP/Ping service is automatically disabled two minutes after the unit is started, or as soon as an IP address is set.
  - Pinging the unit will still be possible when this service is disabled.

**AXIS Internet Dynamic DNS Service** - If the AXIS 241QA/AXIS 241SA has been registered with the Axis Internet Dynamic DNS service and the IP address for the product changes, the service is updated to reflect the change. Check the box to enable/disable automatic updates.

The domain name currently registered at the Axis Internet Dynamic DNS service for your product can at any time be removed. To do this click **Settings...** and follow the instructions. For more information, please refer to the online help .

## Network - Advanced TCP/IP settings

### DNS configuration

DNS (Domain Name System) provides the translation of host names to IP addresses on your network.

**Obtain DNS server address via DHCP** - automatically use the DNS server settings provided by the DHCP server. Click the View button to see the current settings.

**Use the following DNS server address** - enter the desired DNS server by specifying the following:

**Domain name** - enter the domain(s) to search for the host name used by the AXIS 241QA/AXIS 241SA. Multiple domains can be separated by semicolons (;). The host name is always the first part of a Fully Qualified Domain Name, e.g. **myserver** is the host name in the Fully Qualified Domain Name **myserver.mycompany.com** where **mycompany.com** is the Domain name.

**DNS servers** - enter the IP addresses of the primary and secondary DNS servers.

### NTP Configuration

**Obtain NTP server address via DHCP** - use a DHCP server to automatically find an NTP server to synchronize clock of the AXIS 241QA/AXIS 241SA with the other devices on the network

**Use the following NTP server address** - use the host name or IP address of a specific NTP server for time synchronization.

### Host Name Configuration

The AXIS 241QA/AXIS 241SA can be accessed using a host name, instead of an IP address. The host name is usually the same as the assigned DNS Name.

For more information, please see *Security*, on page 45.

### Link-Local address IPv4 Address

This is enabled by default and assigns the AXIS 241QA/AXIS 241SA an additional IP address for use with UPnP™. The AXIS 241QA/AXIS 241SA can have both a Link-Local IP and a static or DHCP-supplied IP address at the same time - these will not affect each other.

### HTTP

The default HTTP port number (80) can be changed to any port within the range 1024-65535. This is useful for simple port mapping.

### HTTPS

The default HTTPS port number (443) can be changed to any port within the range 1024-65535. This is useful for simple port mapping.

### NAT traversal (port mapping) for IPv4

Use NAT traversal when your video server is located on an intranet and you want to make it available from the other side of a NAT router.

### FTP

The FTP server running in the AXIS 241QA/AXIS 241SA enables the upload of new firmware, user applications and so on. Check the box to enable the service.

### RTSP

The RTSP protocol allows a connecting client to start an MPEG-4 stream. Check the box to enable the RTSP server and enter the RTSP port number to use. The default setting is 554, and the allowed port range is 1024-65535. Note that MPEG-4 streams will not be available if this is not enabled.

### Network Traffic

The default setting is **Auto-negotiate** which means that the correct speed is automatically selected. If necessary, you can set the connection speed by selecting it from the drop-down list.

**Maximum bandwidth** - Specify, in Mbit/s or kbit/s, the maximum bandwidth that the video server is allowed to use on your network. This is a useful function when connecting your video server to busy or heavily loaded networks. The default setting is **Unlimited**.

**Note:** When using MPEG-4 as the video format, remember that setting a maximum bandwidth value here may create problems for individual video streams if the maximum value is less than the sum of the bit rates set for the video streams.

For more information, please see the online help 

## **SOCKS**

SOCKS is a networking proxy protocol. The AXIS 241QA/AXIS 241SA can be configured to use a SOCKS server to reach networks on the other side of a firewall/proxy server. This function is useful if the video server is located on a local network behind a firewall, but notifications, uploads, and alarms need to be sent to a destination outside the local network (such as the Internet).

## **QoS**

Quality of Service (QoS) provides the means to guarantee a certain level of a specified resource to selected traffic on a network. Quality can be defined as a maintained level of bandwidth, low latency, and no packet losses. The main benefits of a QoS-aware network can be summarized as:

- the ability to prioritize traffic and thus allow critical flows to be served before flows with lesser priority.
- greater reliability in the network, thanks to the control of the amount of bandwidth an application may use, and thus control over bandwidth races between applications.

The QoS in Axis network video products marks the data packets for various types of network traffic originating from the product. This makes it possible for network routers and switches to reserve a fixed amount of bandwidth for these types of traffic. The following types of traffic are marked:

- live video
- live audio
- event/alarm traffic
- management network traffic.

## **QoS Settings**

For each type of network traffic supported by your Axis network video product, enter a DSCP (Differentiated Services Code Point) value. This value is used to mark the traffic's IP header. When the marked traffic reaches a network router or switch, the DSCP value in the IP header tells the router or switch which type of treatment to apply to this type of traffic, for example, how much bandwidth to reserve for it.

Note that DSCP values can be entered in decimal or hex form, but saved values are always shown in decimal.

More information on Quality of Service at the Axis support web at [www.axis.com/techsup](http://www.axis.com/techsup)

## **SMTP (email)**

Enter the host names or addresses for your primary and secondary mail servers in the fields provided, to enable event and error email messages from the video server to predefined addresses, via SMTP.

If the mail server requires SMTP authentication, check the box for **Use authentication to log in to this server** and enter the user name and password used for logging in. Several different methods of authentication are available. See the online help for more information.

## SNMP

The Simple Network Management Protocol (SNMP) allows the remote management of network devices. Select the version of SNMP to use, depending on the level of security required. These versions have different levels of security. The three levels of security are:

- SNMP V1 and SNMP V2c - use very simple security, for example, using the community name as password
- SNMP V3 - provides encryption and secure passwords. Use with HTTPS.

If using HTTPS, enter the password if it has not already been set. To set the password again, the AXIS 241QA/AXIS 241SA must be reset to the factory default settings.

### Trap reporting for SNMP versions 1 and 2

Network cameras use trap reporting to send messages to a management system for important events, or status changes. When these settings are used with SNMP versions 1 and 2, the security is limited as stated above. Example:

A trap message may be sent indicating that the configure file has changed, or has not changed when SNMP has started; or when a link that has been down, is up again; or when an authentication attempt fails.

### Trap reporting for SNMP versions 3

SNMP v3 is a more secure version providing encryption and secure passwords. To use SNMP v3, HTTPS must be activated. To use traps with SNMP v3, an SNMP v3 management application is needed.

## UPnP™

The video server includes support for UPnP™ in Windows ME and Windows XP. UPnP™ is enabled by default.

**Note:** UPnP™ must be installed on your workstation if running Windows XP. To do this, open the Control Panel from the Start Menu and select **Add/Remove Programs**. Select **Add/Remove Windows Components** and open the **Networking Services** section. Click **Details** and then select **UPnP™** as the service to add.

## RTP / MPEG-4

These settings are the port number, IP address, and Time-To-Live value to use for the media stream(s) in multicast MPEG-4 format. Only certain IP addresses and port numbers should be used for multicast streams. For more information, please see the online help. 

## Bonjour

Your Axis network camera includes support for Bonjour. When enabled, the camera is automatically detected by operating systems and clients that support this protocol.

## Ports & devices

I/O Ports - the pinout, interface support and the control and monitoring functions provided by this connector are described in *Unit connectors*, on page 57.

RS232 - The COM port RS-232 on the AXIS 241QA/AXIS 241SA supports several operational modes listed on this page. For more information, please see *COM ports RS-232 and RS-485*, on page 59.

RS485 - The COM ports on the AXIS 241QA/AXIS 241SA supports several operational modes listed on this page. For more information, please see *COM ports RS-232 and RS-485*, on page 59.

## Maintenance

- **Restart** - The unit is restarted without changing any of the settings. Use this method if the unit is not behaving as expected.
- **Restore** - The unit is restarted and most current settings are reset to factory default values. The settings that are not affected are:
  - the boot protocol (DHCP or static)
  - the static IP address
  - the default router
  - the subnet mask
  - the system time
- **Default** - The default button should be used with caution. Pressing this will return all of the video server's settings to the factory default values (including the IP address)
- **Upgrade Server** - See *Upgrading the firmware*, on page 61.
- **Backup** - To take a backup of all of the parameters, and any user-defined scripts, click this button. If necessary, it is then possible to return to a previous configuration if settings are changed and there is unexpected behavior.
- **Restore** - click the **Browse** button to locate the saved backup file (see above) and then click the **Restore** button. The settings will be restored to the previous configuration.

**Note:** Backup and Restore can only be used on the same unit running the same firmware. This feature is not intended for multi-configurations or for firmware upgrades.

## Support

The **support overview** page provides valuable information on troubleshooting and contact information, should you require technical assistance.

The **System Overview** provides a summary of the status of the video server.

**Logs & Reports** - when contacting Axis support, please be sure to provide a valid Server Report with your query.

**Information** - The Log report and the Parameter List also provide valuable information for troubleshooting and when contacting Axis support service.

### Configuration:

**Log Level for Log Files** - from the drop-down list, select the level of information to be added to the Log file

**Log Level for Email** - from the drop-down list, select the level of information to send as email and enter the destination email address.

## Advanced

Scripting is an advanced function that provides the possibility to customize and use scripts. This function is a very powerful tool.

### Caution!

Improper use may cause unexpected behavior or even cause loss of contact with the unit. If a script does cause problems, reset the unit to its factory default settings. A backup file may be of use to return the unit to its latest configuration).

**Axis strongly recommends that you do not use this function unless you fully understand the consequences.** Note that Axis support does not provide assistance for problems with customized scripts.

For more information, please visit the Developer pages at [www.axis.com/developer](http://www.axis.com/developer)

**Plain Config** - this function is for the advanced user with experience of Axis video server configuration. All parameters can be set and modified from this page, including the audio encoding format. Help is available from the standard help pages.

## Resetting to the factory default settings

To reset the AXIS 241QA/AXIS 241SA to the original default settings, go to the **System Options > Maintenance** web page (described in *Maintenance*, on page 54) or use the control button on the AXIS 241QA/AXIS 241SA, as described below:

### Using the Control Button

Follow the instructions below to reset the AXIS 241QA/AXIS 241SA to the factory default settings using the Control Button.

1. Switch off the AXIS 241QA/AXIS 241SA by disconnecting power.
2. Press and hold the Control Button while reconnecting the power.
3. Keep the Control button pressed until the Status Indicator displays amber (this may take up to 15 seconds).
4. Release the Control Button.
5. When the Status Indicator changes to Green (may take up to 1 minute), the process is complete and the AXIS 241QA/AXIS 241SA has been reset.
6. Re-install the AXIS 241QA/AXIS 241SA, as described in the Installation Guide.

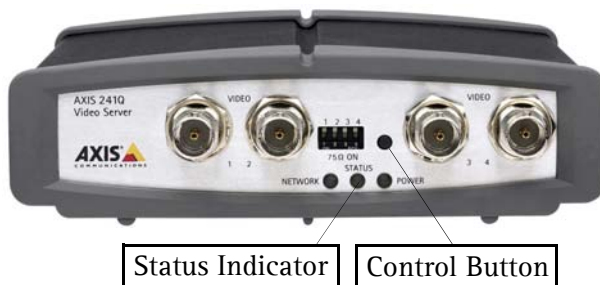



## Unit connectors

The following connectors are described in this section:

- *The D-Sub connector, on page 57*
- *The I/O terminal connector, on page 58*
- *COM ports RS-232 and RS-485, on page 59*

### The D-Sub connector

The AXIS 241QA/AXIS 241SA provides one 9-pin D-Sub connector, providing the physical interface for an RS-232 port, used for connecting accessory equipment; such as standalone PTZ devices for the remote control of connected video cameras.

Pin assignment table and pinout of the RS-232 connector:

Pin	Function
1	CD
2	RXD
3	TXD
4	DTR
5	GND
6	DSR
7	RTS
8	CTS
9	RI

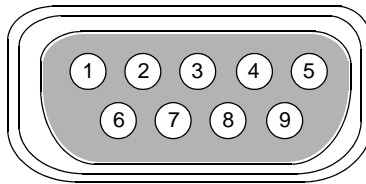

## The I/O terminal connector

This section describes the pinout and interface support provided by the 12-pin I/O terminal connector, which includes:

- 4 digital transistor outputs
- 4 digital inputs
- an RS-485 interface
- auxiliary power and GND

The terminal connector is used in applications for e.g. motion detection, event triggering, time lapse recording, alarm notification via email, image storage to FTP locations, etc.

- **Inputs** - e.g. a push button. If the button is pressed, the state changes, and the input will be active (shown under **Event Configuration > Port Status**).
- **Outputs** - e.g. an alarm device that can be activated from Output buttons on the **Live View** page or as an action to an **Event Type**. The output will show as active (in **Event Configuration > Port Status**), if the device is activated.

Pin	Function	Description
1	Auxiliary DC Power Input	7-20 VDC/min 8W. Electrically connected in parallel with the power connector, this provides an auxiliary connection for mains power to the unit. If the product is powered via this pin, use a fuse (rating: 1A Slow). This pin can also be used to power auxiliary equipment, 9vDC max 100mA.
2	GND	ground
3	Digital Input 1	Connect to GND to activate or leave floating (or unconnected) to deactivate.
4	Digital Input 2	
5	Digital Input 3	
6	Digital Input 4	
7	Transistor Output	With a maximum load of 100mA and maximum voltage of 24V DC, this output has an open-collector NPN transistor with the emitter connected to pin 2 (GND). If it is to be used with an external relay, a diode must be connected in parallel with the load for protection against any voltage transients.
8	Transistor Output	
9	Transistor Output	
10	Transistor Output	
11	RS-485 - A (non-inverting)	A half-duplex RS-485 interface for controlling auxiliary equipment, e.g. PTZ devices.
12	RS-485 - B (inverting)	

The AXIS 241QA/AXIS 241SA includes one (green) 12-pin connector block. Connect input/output devices to this block:

1. Loosen the corresponding screw on top of the pin on the connector block (see the table above to determine which pin to use).
2. Push the cable into the connector block and secure it by fastening the screw.
3. Once all devices are connected, connect the connector block to the video server's terminal connector.

## Schematic diagram - I/O terminal connector

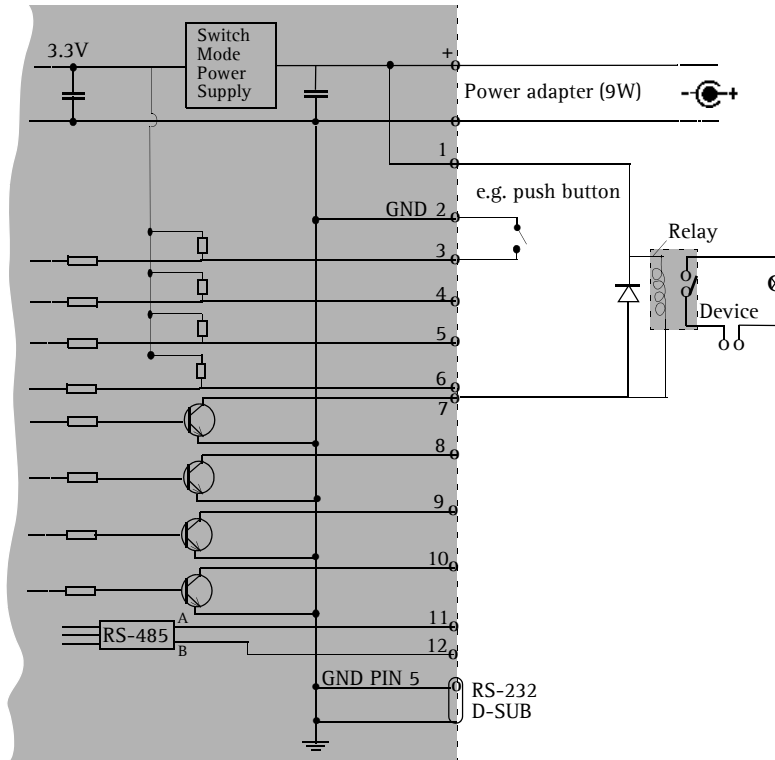

## COM ports RS-232 and RS-485

The COM Ports RS-232 and RS-485 support several operational modes:

- **Generic TCP/IP** - enables the video server to receive status/data and send commands via TCP/IP
- **Generic HTTP** - enables the video server to receive status/data and send commands via HTTP
- **Pan Tilt Zoom (PTZ)** - for controlling a PTZ device. A PTZ device requires a driver for its function. Drivers can be obtained from [www.axis.com](http://www.axis.com). Please see page 37 for information on how to connect PTZ devices.



# Troubleshooting

---

## Checking the firmware

Firmware is software that determines the functionality of the AXIS 241QA/AXIS 241SA. One of your first actions when troubleshooting a problem should be to check the currently installed version. The latest version may contain a correction that fixes your particular problem. The current firmware version in your AXIS 241QA/AXIS 241SA can be seen under **Setup > Basic Configuration**.

## Upgrading the firmware

When you download the latest firmware from the Axis Web site, your Axis product will receive the latest available functionality. Always read the upgrade instructions and release notes available with each new release, before updating the firmware.

New firmware can be downloaded to the AXIS 241QA/AXIS 241SA over the network.

**Note:** Pre-configured and customized settings will be retained for use when the new firmware is running (provided the features are available in the new firmware) although this is not guaranteed by Axis Communications.

1. Save the firmware file to your computer. The latest version of the AXIS 241QA/AXIS 241SA firmware is available free of charge from the Axis Web site at [www.axis.com/techsup](http://www.axis.com/techsup) or from your local distributor.
2. Go to **Setup > System Options > Maintenance** in the video server's Web pages.
3. In the **Upgrade Server** section and browse to the desired firmware file on your computer. Click **Upgrade**.

### Upgrade Server

Upgrade the AXIS 241Q Video Server with the latest firmware.

Specify the firmware to upgrade to:   and click

**Note:** Do not disconnect power to the unit during the flash upgrade. The unit restarts automatically after the upgrade has completed. (1-10 minutes.)

- Notes:**
- Always read the upgrade instructions available with each new release, before updating the firmware.
  - After starting the process, you should always wait at least 20 minutes before restarting the AXIS 241QA/AXIS 241SA, even if you suspect the procedure has failed.
  - Your dealer reserves the right to charge for any repair attributable to faulty updating by the user.

## Emergency recovery procedure

If power or the network connection to the AXIS 241QA/AXIS 241SA is lost during the upgrade, the process will fail and the unit will become unresponsive. A flashing red Status LED indicates a failed upgrade. To recover the unit, follow the steps below. The serial number is found on the underside label on the product casing.

1. **Unix/Linux** - From the command line, type the following:

```
arp -s <IP address of AXIS 241QA/AXIS 241SA> <serial number> temp
ping -s 408 <IP address of AXIS 241QA/AXIS 241SA>
```

**Windows** - From a command/DOS prompt, type the following:

```
arp -s <IP address of AXIS 241QA/AXIS 241SA> <serial number>
ping -l 408 -t <IP address of AXIS 241QA/AXIS 241SA>
```

2. If the unit does not reply within a few seconds, restart it and wait for a reply. Press CTRL+C to stop Ping.
3. Open a web browser and type in the IP address for AXIS 241QA/AXIS 241SA. In the page that appears, use the **Browse** button to select the upgrade file to use, e.g. axis241qa.bin or axis241sa.bin. Then click the **Load** button to restart the upgrade process.
4. After the upgrade has completed (1-10 minutes), the unit will automatically restart and show a steady green on the Power and Status LEDs and flashing green or amber on the Network LED.
5. Reinstall the AXIS 241QA/AXIS 241SA.
6. **Windows** - If you are using a DHCP server, type the following from a command/DOS prompt:  
arp -d <IP address of AXIS 241QA/AXIS 241SA>

If the emergency recovery procedure does not get the AXIS 241QA/AXIS 241SA up and running again, please contact Axis support at [www.axis.com/techsup/](http://www.axis.com/techsup/)

## Support

If you contact Axis support, please help us help you resolve your problems expediently by providing a server report, log file and a brief description of the problem.

**Server Report** - go to **Setup > System Options > Support Overview**. The server report contains important information about the server and its software, as well as a list of the current parameters.

**Log file** - go to **Setup > System Options > Logs & Reports**. The Log file records events within the unit since the last restart of the system and can prove a useful diagnostic tool for troubleshooting.

## Symptoms, Possible Causes and Remedial Actions

### Problems setting the IP address

Using ARP/Ping - the IP address must be set within two minutes after power has been applied to the video server	Restart the server and try again. Ensure also the ping length is set to 408. (See the AXIS 241QA/AXIS 241SA Installation Guide)
The video server is located on a different subnet.	If the IP address intended for the AXIS 241QA/AXIS 241SA and the IP address of your computer are located on different subnets, you will not be able to set the IP address. Contact your network administrator for an IP address on the same subnet as the computer you are performing the installation from.
The IP address is being used by another device	<p>Disconnect power from the AXIS 241QA/AXIS 241SA.</p> <p>Run the Ping command (in a Command/DOS window, type <code>ping &lt;IP address of unit&gt;</code>)</p> <p>If you receive: <b>Reply from &lt;IP address&gt;: bytes = 32; time = 10 ms.....</b> - this means that the IP address may already be in use by another device on your network. You must obtain a new IP address and reinstall the unit.</p> <p>If you receive: <b>Request timed out</b> - this means that the IP address is available for use with your video server. In this case, check all cabling and reinstall the unit.</p>

### The AXIS 241QA/AXIS 241SA cannot be accessed from a web browser

Cannot log in	If the AXIS 241QA/AXIS 241SA has been configured to use HTTPS, check that the protocol in the URL used to access the unit is correct. You may need to type this in manually (i.e. http or https) in the browser's address field.
The IP address has been changed by DHCP	<ol style="list-style-type: none"> <li>1) Move the AXIS 241QA/AXIS 241SA to an isolated network or to one with no DHCP or BOOTP server. Set the IP address again, using the ARP Ping command.</li> <li>2) Access the unit and disable BOOTP and DHCP in the TCP/IP settings. Return the unit to the main network. The unit now has a fixed IP address that will not change.</li> <li>3) As an alternative to 2), if dynamic IP address via DHCP or BOOTP is required, select the required service and then configure IP address change notification from the network settings. Return the unit to the main network. The unit will now have a dynamic IP address, but will notify you if the address changes.</li> </ol>
Other networking problems	Test the network cable by connecting it to another network device, then Ping that device from your workstation. See instructions above.

### Cannot send notifications, uploads, alarms, etc, to a destination outside the local network

Firewall protection	The video server can be configured to use a SOCKS server to reach networks on the other side of a firewall/proxy server
---------------------	---

### Your AXIS 241QA/AXIS 241SA is accessible locally, but not externally

Firewall protection	Check the Internet firewall with your system administrator.
Default routers required	Check if you need to configure the default router settings.
The Internet site is too heavily loaded	Use a script on your web server to relay images from the AXIS 241QA/AXIS 241SA to the Internet.

### The Power indicator is not constantly lit

Faulty power supply	Verify that you are using the correct power adapter.
---------------------	--

### The Status indicator is flashing red and the server is inaccessible

A firmware upgrade has been interrupted or the firmware has been damaged in some other way.	A rescue firmware is running in the product. First, set the IP address using AXIS IP utility or ARP and Ping, (See the AXIS 241QA/AXIS 241SA Installation Guide). Then, using a web browser, access the unit and download the latest firmware to the product, see <i>Upgrading the firmware</i> , on page 61.
---	---

**No images displayed in the Web interface**

Problem with AMC ( <i>Internet Explorer only</i> )	To enable the updating of images in Microsoft Internet Explorer, set your browser to allow ActiveX controls. Also, make sure that AXIS Media Control (AMC) component is installed on your workstation.
Installation of additional ActiveX component restricted or prohibited	Configure your AXIS 241QA/AXIS 241SA to use a Java applet for updating the images under Live View Config > Layout > Default Viewer for Internet Explorer. See the online help for more information.

**Video Image Problems**

Image too dark or too light.	Check that the termination dip switch for the video source is set to the correct position. See also the online help on Video Source Settings
Black borders around the video image	Adjust the X and/or Y offset, in the Video Source Settings. See the online help for information.
Problems uploading own files	There is only limited space available for the upload of your own files. Try deleting one or more existing files, to free up space
Missing images in uploads	This can occur when trying to use a larger image buffer than is actually available. Try lowering the frame rate or the upload period.
Slow image update	Configuring e.g. pre-buffers, motion detection, high resolution images, high frame rates, etc., will reduce the performance of the video server.
Slow performance	Slow performance may be caused by e.g. heavy network traffic, multiple users accessing the unit, low performance clients, use of features such as Motion Detection, Event handling, Image rotation.

**Bad snapshot images**

Display incorrectly configured on your workstation	In Display Properties, configure your display to show at least 65000 colors, i.e. at least 16-bit. Using only 16 or 256 colors on your display will produce dithering artifacts in the image.
--	---

**Incorrect exposure in images**

Incorrect line termination	If the AXIS 241QA/AXIS 241SA is to be connected in loop through with other equipment, disable the input termination by turning the corresponding DIP switch to OFF.
----------------------------	---

**Problems with the MPEG-4 format**

Lower frame rate than expected.	<p>Check with the administrator that there is enough bandwidth available. Check also the settings for bit rate control, in the <b>Video &amp; Image &gt; Advanced &gt; MPEG-4</b> settings. Using an inappropriate video object type can also affect the frame rate. See the online help for more information.</p> <p>Check in the AMC control panel applet (MPEG-4 tab) that video processing is not set to <b>Decode only I frames</b>.</p> <p>Lower the image resolution.</p> <p>Reduce the number of applications running on the client computer.</p>
No MPEG-4 displayed in the client.	<p>Check that the correct network interface is selected in the AMC control panel applet (network tab).</p> <p>Check that the relevant MPEG-4 connection methods are enabled in the AMC control panel applet (network tab).</p> <p>In the AMC control applet, select the MPEG-4 tab and click the button Set to default MPEG-4 decoder.</p>
No multicast MPEG-4 displayed in the client.	<p>Check with your network administrator that the multicast addresses used by the AXIS 241QA/AXIS 241SA are valid for your network.</p> <p>Check with your network administrator to see if there is a firewall preventing viewing.</p>
Multicast MPEG-4 only accessible by local clients.	Check if your router supports multicasting, or if the router settings between the client and the server need to be configured. The TTL (Time To Live) value may need to be increased.



Poor rendering of MPEG-4 images.	Color depth set incorrectly on clients. Set to 16-bit or 32-bit color. If text overlays are blurred, or if there are other rendering problems, you may need to enable Advanced Video Rendering. This is done on the MPEG-4 tab in the AMC control panel applet. Ensure that your graphics card is using the latest device driver. The latest drivers can usually be downloaded from the manufacturer's web site.
Color saturation is different in MPEG-4 and Motion JPEG.	Modify the settings for your graphics adapter. Please see the adapter's documentation for more information.
<b>No audio (AXIS 241QA only)</b>	
Incorrect setup.	Check that the sound card in the PC and the connections to the speaker and microphone are working. Ensure that the mute button is not pressed and the volume settings are correct. Ensure that full-duplex is selected if you want to have two way audio communication.
Post Content Length in proxy server.	The Post Content Length set in the proxy server is too low. Set the value of the Post Content Length in your proxy server to 1MB or more. You may need to contact your system administrator to do this.
Full duplex not supported.	Sound card does not support full-duplex. For information on how to check if your sound card supports full-duplex, please visit <a href="http://support.microsoft.com">http://support.microsoft.com</a>
Firewall or router settings.	AXIS 241QA works locally, but not externally. Check the Internet firewall settings with your system administrator or reconfigure the default router settings.
DC power not enabled for microphone.	If the microphone has a built-in amplifier then DC power must be enabled on the Audio Settings page.
<b>Audio volume too low/high</b>	
Volume settings incorrect.	The volume of the microphone or speaker connected to the AXIS 241QA/AXIS 241SA is either too high or too low. Change the volume for the speaker or microphone in the Live View page.
Input and output gain set incorrectly.	Change the input gain for the microphone and the output gain for the speaker to adjust the audio levels on the Audio Settings page.
<b>Poor audio quality</b>	
Too many users.	Too many users/clients listening to audio from the AXIS 241QA/AXIS 241SA may adversely affect the sound quality.
User too close to microphone.	Enable the speech filter in <b>Audio &gt; Advanced Settings</b> .
Feedback from speaker.	Enable the echo cancellation filter in <b>Audio &gt; Advanced Settings</b> .
Background noise.	Adjust the noise cancellation threshold and attenuation to reduce background noise levels in <b>Audio &gt; Advanced Settings</b> .
CPU overloaded.	Reduce the number of listeners and viewers and decrease the image resolution and compression.

For additional assistance, please contact your reseller or check the product's support pages on the Axis Website at [www.axis.com/techsup](http://www.axis.com/techsup)

## Technical specifications

Item	Specification
Models	<ul style="list-style-type: none"> <li>• AXIS 241QA: Four video channels, two-way audio</li> <li>• AXIS 241SA: One video channel, two-way audio</li> <li>* Also available as Blade versions for Axis Video Rack Solution</li> </ul>
Video compression	<ul style="list-style-type: none"> <li>• Motion JPEG</li> <li>• MPEG-4 Part 2 (ISO/IEC 14496-2), Profiles: ASP and SP</li> </ul>
Resolutions	<ul style="list-style-type: none"> <li>• Resolutions 4CIF, 2CIFExp, 2CIF, CIF, QCIF</li> <li>• max 704x480 (NTSC) 704x576 (PAL)</li> <li>• min 176x120 (NTSC) 176x144 (PAL)</li> </ul>
Frame rate (NTSC/PAL)	<ul style="list-style-type: none"> <li>• Motion JPEG: Up to 30/25 fps at 4CIF (1 channel) 30/25 fps at CIF (4 channel)</li> <li>• MPEG-4: Up to 30/25 fps at 2CIF (1 channel) 21/17 fps at 4CIF (1 channel) 20/17 fps at CIF (4 channel)</li> </ul>
Video streaming	<ul style="list-style-type: none"> <li>• Simultaneous Motion JPEG and MPEG-4</li> <li>• Controllable frame rate and bandwidth</li> <li>• Constant and variable bit rate (MPEG-4)</li> </ul>
Image settings	<ul style="list-style-type: none"> <li>• Compression levels: 11 (Motion JPEG) /23 (MPEG-4)</li> <li>• Rotation: 90°, 180°, 270°</li> <li>• Aspect ratio correction</li> <li>• Color: color, black &amp; white</li> <li>• Overlay capabilities: time, date, text or image</li> <li>• De-interlace filter (AXIS 241QA)</li> </ul>
Pan/Tilt/Zoom	<ul style="list-style-type: none"> <li>• A wide range of analog PTZ dome cameras is supported, free drivers available at <a href="http://www.axis.com">www.axis.com</a></li> <li>• 20 presets/camera</li> <li>• Guard tour</li> <li>• PTZ control queue</li> </ul>
Audio (AXIS 241QA)	<ul style="list-style-type: none"> <li>• G.711 PCM 64kbit/s,</li> <li>• G.726 ADPCM 32 or 24 kbit/s</li> <li>• Full duplex</li> <li>• Half duplex</li> <li>• Simplex or audio off</li> </ul>
Security	<ul style="list-style-type: none"> <li>• Multiple user access levels with password protection</li> <li>• IP address filtering and HTTPS encryption</li> <li>• IEEE 802.1X authentication</li> </ul>
Alarm and event management	<ul style="list-style-type: none"> <li>• Events triggered by built-in motion detection, external inputs or according to a schedule,</li> <li>• Image upload over FTP, Email, and HTTP,</li> <li>• Notification over TCP, Email, HTTP and external outputs</li> <li>• Pre- and post alarm buffer of 9 MB per channel (approx. 4 min of CIF resolution video at 4 frames per second)</li> </ul>

Item	Specification
Connectors	<ul style="list-style-type: none"> <li>• Analog composite video,</li> <li>• NTSC/PAL autosensing inputs:</li> <li>• AXIS 241QA: 4 BNC inputs</li> <li>• AXIS 241SA: 1 BNC input and 1 BNC output: loop through or Y/C video input</li> <li>• Ethernet 10BaseT/100BaseTX, RJ-45</li> <li>• Terminal block:               <ul style="list-style-type: none"> <li>4 alarm inputs,</li> <li>4 alarm outputs,</li> <li>RS-485/422 half duplex port,</li> <li>Alternative power connection</li> </ul> </li> <li>• D-Sub for RS-232 port</li> <li>• AXIS 241QA/AXIS 241SA: 3.5 mm jack for Mic in (max 54 mVpp) or Line in (max 8.0 Vpp, mono),</li> <li>• 3.5 mm jack for Line out (max 2.6 Vpp, mono) to active speaker</li> </ul>
Casing	<ul style="list-style-type: none"> <li>• Metal casing. Standalone, stackable or with brackets for wall or cage mount</li> </ul>
Processors and memory	<ul style="list-style-type: none"> <li>• CPU: ETRAX 100LX 32bit</li> <li>• Video processing and compression: ARTPEC-2</li> <li>• RAM: 64MB (AXIS 241QA), 32 MB (AXIS 241SA)</li> <li>• Flash: 8 MB</li> <li>• Battery backed up by real-time clock</li> </ul>
Power	<ul style="list-style-type: none"> <li>• 7 - 20 V DC, max 8 W</li> </ul>
Operating conditions	<ul style="list-style-type: none"> <li>• 5 - 50 °C (41 - 122 °F)</li> <li>• Humidity 20 - 80% RH (non-condensing)</li> </ul>
Installation, management and maintenance	<ul style="list-style-type: none"> <li>• Installation tool on CD and web-based configuration</li> <li>• Configuration backup and restore</li> <li>• Firmware upgrades over HTTP or FTP, firmware available at <a href="http://www.axis.com">www.axis.com</a></li> </ul>
Video access from Web browser	<ul style="list-style-type: none"> <li>• Camera live view</li> <li>• Sequence tour capability for up to 20 PTZ presets or other Axis video sources</li> <li>• Customizable HTML pages</li> </ul>
Minimum Web browsing requirements	<ul style="list-style-type: none"> <li>• Pentium III CPU 500 MHz or higher, or equivalent AMD128 MB RAM AGP graphic card, Direct Draw, 32 MB RAM</li> <li>• Windows XP, 2000, Server 2003, NT4.0*, ME* or 98*, DirectX 9.0 or later Internet Explorer 5.x or later</li> <li>• For other operating systems and browsers see <a href="http://www.axis.com/techsup">www.axis.com/techsup</a></li> </ul> <p>*Motion JPEG only</p>
System integration support	<ul style="list-style-type: none"> <li>• Powerful API for software integration available at <a href="http://www.axis.com">www.axis.com</a>, including AXIS VAPIX API, AXIS Media Control SDK, event trigger data in video stream, embedded scripting and access to serial port peripherals over HTTP/TCP</li> <li>• Watchdog secures continuous operation, can be monitored by other systems via event notification</li> <li>• Embedded operating system: Linux 2.6</li> </ul>
Supported protocols	<ul style="list-style-type: none"> <li>• HTTP, HTTPS, SSL/TLS*, TCP, SNMPv1/v2cv/v3 (MIB-II), RTSP, RTP, UDP, IGMP, RTCP, SMTP, FTP, DHCP, UPnP, ARP, DNS, DynDNS, SOCKS. More information on protocol usage available at <a href="http://www.axis.com">www.axis.com</a></li> </ul> <p>* This product includes software developed by the Open SSL Project for use in the Open SSL Toolkit.</p>

<b>Item</b>	<b>Specification</b>
<b>Included accessories</b>	<ul style="list-style-type: none"> <li>• Power supply 9 V DC, mounting brackets, connector kit, Installation Guide, CD with installation and management tools, software and User's Manual, MPEG-4 licenses (1 encoder, 1 decoder), MPEG-4 decoder (Windows)</li> </ul>
<b>Applications (not included)</b>	<ul style="list-style-type: none"> <li>• AXIS Camera Station - Surveillance application for viewing, recording and archiving up to 25 cameras</li> <li>• AXIS Camera Recorder - Surveillance application for viewing and recording up to 16 cameras</li> <li>• AXIS Camera Explorer - Basic software for viewing and manual recording</li> <li>• See <a href="http://www.axis.com/partner/adp_partners.htm">www.axis.com/partner/adp_partners.htm</a> for more software applications via partners</li> </ul>
<b>Accessories (not included)</b>	<ul style="list-style-type: none"> <li>• AXIS 292 Network Video Decoder</li> <li>• AXIS MPEG-4 Decoder 10 user license pack</li> <li>• Power over Ethernet splitters and midspans IEEE 802.11g wireless bridge and access point</li> </ul>
<b>Approvals</b>	<ul style="list-style-type: none"> <li>• EMC: EN55024: 1998+A1, EN55022:1998 ClassB EN61000-3-2:2000, EN61000-3-3:1995+A1</li> <li>• FCC Part 15 Subpart B Class B</li> <li>• VCCI: 2003 Class B ITE</li> <li>• C-tick AS/NZS 3548 and ICES-003 Class B by compliance with EN 550022:1998 Class B</li> <li>• Safety: UL and CSA (Power supply), EN60950</li> </ul>
<b>Dimensions (HxWxD) and weight</b>	<ul style="list-style-type: none"> <li>• 42 x 140 x 155 mm (1.7" x 5.5" x 6.1")</li> <li>• 540 g (1.2 lbs) excl. power supply</li> </ul>

## General performance considerations

When setting up your system, it is important to consider how various settings and situations will affect performance. Some factors affect the amount of bandwidth (the bit rate) required, others can affect the frame rate, and some will affect both. If the load on the CPU reaches its maximum, this will also affect the frame rate.

The following factors are among the most important to consider:

- High image resolutions and/or lower compression levels result in larger images. Bandwidth affected.
- Access by large numbers of Motion JPEG and/or unicast MPEG-4 clients. Bandwidth affected.
- Simultaneous viewing of different streams (resolution, compression, etc.) by different clients. Frame rate and bandwidth affected.
- Accessing both Motion JPEG and MPEG-4 video streams simultaneously. Frame rate and bandwidth affected.
- Heavy usage of event settings affects the CPU load. Frame rate affected.
- Enabled motion detection. Frame rate and bandwidth affected.
- Heavy network utilization due to poor infrastructure. Bandwidth affected
- Viewing on poorly performing client PC lowers perceived performance. Frame rate affected.
- Access by large number of audio clients using full-duplex mode. Bandwidth affected.

## Optimizing your system

To see the bandwidth and frame rate currently required by the video stream, the AXIS 241QA/AXIS 241SA provides a tool that can be used to display these values directly in the video image.

To do this, special format strings are added as part of a text overlay. Simply add **#r** (average frame rate in fps) and/or **#b** (average bandwidth in Kbps) to the overlay.

For detailed instructions, please see the online help for **Video & Image > Overlay Settings**, and the help for **File Naming & Date/Time Formats**.

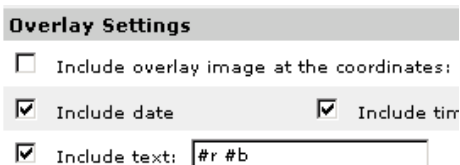

**Important!**

- The figures displayed here are the values as delivered by the server. If other restrictions are currently in force, (e.g. bandwidth limitation) these values might not correspond to those actually received by the client.
- For Motion JPEG, these values will only be accurate as long as no frame rate limit has been specified.

**Frame rates - Motion JPEG**

The following test results show the frame rates in frames/second (fps) for Motion JPEG streams from the AXIS 241QA/AXIS 241SA, using a compression level of 50%. Note that these values are guidelines only - actual values may vary.

	AXIS 241QA/AXIS 241SA	
	fps (NTSC/PAL) 1 channel	fps (NTSC/PAL) 4 channels
4CIF	30/25	10/8
2CIF expanded	30/25	15/13
2CIF	30/25	27/22
CIF	30/25	30/25
QCIF	30/25	30/25

**Frame rates - MPEG-4**

The following test results show the frame rates in frames/second (fps) for MPEG-4 streams from the AXIS 241QA/AXIS 241SA. Note that these values are guidelines only - actual values may vary.

The MPEG-4 test conditions:

- Compression level = 50%
- Video Object Type = Advanced Simple
- GOV structure = IP\*

	AXIS 241QA/AXIS 241SA	
	fps (NTSC/PAL) 1 channel	fps (NTSC/PAL) 4 channels
4CIF	21/17	4/3
2CIF expanded	21/17	5/4
2CIF	30/25	10/9
CIF	30/25	20/17
QCIF	30/25	30/25

Note that setting the GOV structure to use "I-frames only" will increase the frame rate.

\* The GOV structure can take two different forms; I and IP. The I-structure sends complete images (I-images) whereas the IP-structure mostly sends the differences compared with the previous image (P-images) and only a few I-images. The IP-structure requires much less bandwidth than the I-structure.

## Bandwidth

As there are many factors affecting bandwidth, it is very difficult to predict the required amounts. The settings that affect bandwidth are:

- the image resolution
- the image compression
- the frame rate
- the MPEG-4 object type
- the MPEG-4 GOV structure
- the analog cameras connected to the video server
- the audio settings

There are also factors in the monitored scene that will affect the bandwidth. These are:

- the amount of motion
- the image's complexity
- the lighting conditions.

For MPEG-4, if there is only limited bandwidth available, and if this is more important than the image quality, using a constant bit rate (CBR) is recommended. Use a variable bit rate (VBR) if the image quality needs to be maintained at a higher level. If supported on the network, consider also using MPEG-4 multicasting, as the bandwidth consumption will be much lower.

## Glossary

---

**Active Speaker** - a speaker with a built-in power amplifier.

**ActiveX** - ActiveX is a standard that enables software components to interact with one another in a networked environment, regardless of the language(s) used to create them. Web browsers may come into contact with ActiveX controls, ActiveX documents, and ActiveX scripts. ActiveX controls are often downloaded and installed automatically as required.

**AF (Autofocus)** - A system by which the camera lens automatically focuses on a selected part of the subject.

**AMC (AXIS Media Control)** - AMC is the ActiveX component required to view moving images from an Axis video device in Internet Explorer. The component is installed automatically on the viewing computer on first use. Once installed, AMC can be configured from Windows Control Panel.

**Analog video camera** - The signal from an analog video camera is viewed directly on e.g. a monitor in the analog system, which depends on traditional analog cabling. Alternatively, the signal can be digitized with the use of a video server, and can then be made available over a data (IP) network.

**Angle** - The field of view, relative to a standard lens in a 35mm still camera, expressed in degrees, e.g. 30°. For practical purposes, this is the area that a lens can cover, where the angle of view is determined by the focal length of the lens. A wide-angle lens has a short focal length and covers a wider angle of view than standard or telephoto lenses, which have longer focal lengths.

**API (Application Programming Interface)** - An API is a set of routines, protocols, and tools for building software applications. A good API makes it easier to develop a program by providing all the required building blocks. The Axis VAPIX API allows Axis products to be integrated into other applications.

**ARP (Address Resolution Protocol)** - This protocol is used to associate an IP address to a hardware MAC address. A request is broadcast on the local network to discover the MAC address for an IP address.

**ARTPEC (Axis Real Time Picture Encoder)** - A chip designed by Axis for image compression. ARTPEC supports a range of CCD and CMOS sensors, built-in functionality for sharpening, backlight compensation, noise reduction and white balance, support for multiple Motion-JPEG streams, support for MPEG-4 part 2, up to 30 frames/second from 4 simultaneous video sources and real-time compression of up to 45 Megapixels/second.

**ASIC (Application Specific Integrated Circuit)** - A circuit designed for a specific application, as opposed to a general purpose circuit, such as a microprocessor.

**Aspect ratio** - A ratio of width to height in images. A common aspect ratio used for television screens and computer monitors is 4:3. High-definition television (HDTV) uses an aspect ratio of 9:16.

**Autoiris (DC-Iris)** - This special type of iris is electrically controlled by the camera, to automatically regulate the amount of light allowed to enter.

**AVI (Audio Video Interleave)** - A video format that supports simultaneous playback of audio and video.

**AXIS Internet Dynamic DNS Service** - This free service provides an Axis network product with a unique DNS or domain name (URL address), which can then be used instead of an IP address to access the product from a web browser.

**AXIS IP Utility** - A tool for discovering and setting IP addresses for Axis network devices. AXIS IP Utility is supplied free of charge by Axis.

**AXIS Camera Management** - A powerful and efficient installation and management tool for Axis network video products. The tool can automatically find and set IP addresses, show connection status and manage firmware upgrades of multiple devices.

**Bitmap** - A bitmap is a data file representing a rectangular grid of pixels. It defines a display space and color for each pixel (or "bit") in the display space. This type of image is known as a "raster graphic." GIFs and JPEGs are examples of image file types that contain bitmaps. Because a bitmap uses this fixed raster method, it cannot easily be rescaled without losing definition. Conversely, a vector graphic image uses geometrical shapes to represent the image, and can thus be quickly rescaled.

**Bit rate** - The bit rate (in kbit/s or Mbit/s) is often referred to as speed, but actually defines the number of bits/time unit and not distance/time unit.

**Bluetooth** - Bluetooth is an open standard for wireless transmission of voice and data between mobile devices (PCs, handheld computers, telephones and printers).

**Bonjour** - Also known as zero-configuration networking, Bonjour enables the automatic discovery of computers, devices, and services on IP networks. Bonjour allows devices to automatically discover each other without the need to enter IP addresses or configure DNS servers. Bonjour is developed by Apple Computer Inc.

**BOOTP (Bootstrap Protocol)** - A protocol that can automatically configure a network device (give it an IP address). BOOTP is the basis for a more advanced network management protocol, the Dynamic Host Configuration Protocol (DHCP).

**Broadband** - In network engineering terms, this describes transmission methods where two or more signals share the same carrier. In more popular terminology, broadband is taken to mean high-speed data transmission.



**CCD (Charged Coupled Device)** - This light-sensitive image device used in many digital cameras is a large integrated circuit that contains hundreds of thousands of photo-sites (pixels) that convert light energy into electronic signals. Its size is measured diagonally and can be 1/4", 1/3", 1/2" or 2/3".

**CCTV (Closed Circuit Television)** - A CCTV system is a closed/private video system, usually constructed with coaxial cabling, and used within a single building/group of buildings. It is used to visually monitor the location for security or industrial purposes. Video from the CCTV system can be recorded and viewed on-site or remotely.

**CCTV video camera** - A traditional CCTV video camera is an analog camera, available in both monochrome (black and white) and color. Cameras can be set in fixed positions or placed on "Pan/Tilt/Zoom" devices, which allow the camera to be maneuvered. Using a zoom lens provides a closer view of the object being viewed. CCTV analog video cameras can be viewed over a computer network by using a video server.

**CGI (Common Gateway Interface)** - A specification for communication between a web server and other (CGI) programs. For example, a HTML page that contains a form might use a CGI program to process the form data once it is submitted.

**CIF (Common Intermediate Format)** - CIF refers to the analog video resolutions 352x288 pixels (PAL) and 352x240 pixels (NTSC). See also *Resolution*.

**Client-server** - Client-server describes the relationship between two computer programs in which one program, the client, makes a service request from another program, the server, which fulfils the request. Typically, multiple client programs share the services of a common server program. A web browser is a client program that requests services (the sending of web pages or files) from a web server.

**CMOS (Complementary Metal Oxide Semiconductor)** - A CMOS is a widely used type of semiconductor that uses both negative and positive circuits. Since only one of the circuit types is on at any given time, CMOS chips require less power than chips using just one type of transistor. CMOS image sensors also allow processing circuits to be included on the same chip, an advantage not possible with CCD sensors, which are also much more expensive to produce.

**Coaxial cable** - Coaxial cable is the standard means of transmitting analog video in a CCTV system. Coaxial is also used by cable companies to distribute television in residential buildings.

**Codec** - In communications engineering, a codec is usually a coder/decoder. Codecs are used in integrated circuits or chips that convert e.g. analog video and audio signals into a digital format for transmission. The codec also converts received digital signals back into analog

format. A codec uses analog-to-digital conversion and digital-to-analog conversion in the same chip.

Codec can also mean compression/decompression, in which case it is generally taken to mean an algorithm or computer program for reducing the size of large files and programs.

**Composite video** - A type of video signal in which the red, blue and green signals (sometimes audio signals too) are mixed together.

**Compression** - See *Image Compression*.

**Contrast** - Defines the degree of difference between the lightest and darkest parts of an image or video stream.

**Control unit** - If a CCTV system has more than one camera, there must be a way to control the video signals going to recorders and monitors. There are three basic types of Video Control Unit: Multiplexer, Switch and Quad.

**dB (Decibels)** - A unit to measure sound level changes. A 3dB change is the smallest level change we can hear. A 3dB change is actually twice or half the audio power level. A gain of 0dB will leave the signal level unchanged.

**DC-Iris** - This special type of iris is electrically controlled by the camera, to automatically regulate the amount of light allowed to enter.

**Decoder** - See *video decoder*.

**De-interlacing** - See *interlacing*.

**DHCP (Dynamic Host Configuration Protocol)** - DHCP is a protocol that lets network administrators automate and centrally manage the assignment of Internet Protocol (IP) addresses to network devices in a network.

DHCP uses the concept of a "lease" or amount of time that a given IP address will be valid for a computer. The lease time can vary, depending on how long a user is likely to require the network connection at a particular location.

DHCP also supports static addresses for e.g. computers running web servers, which need a permanent IP address.

**DNS (Domain Name System)** - DNS is used to locate and translate Internet domain names into IP (Internet Protocol) addresses. A domain name is a meaningful and easy-to-remember name for an Internet address. For example the domain name www.example.com is much easier to remember than 192.0.34.166. The translation tables for domain names are contained in Domain name servers.

**Domain server** - Domains can also be used by organizations that wish to centralize the management of their (Windows) computers. Each user within a domain has an account that usually allows them to log in to and use any computer in the domain, although restrictions may also apply. The domain server is the server that authenticates the users on the network.

**Dome network camera** - A remotely controllable camera mounted in a special housing, characterized by the dome shaped glass or plastic covering behind which the camera resides. Usually mounted on a ceiling and looking downwards, a dome camera can often rotate up to 360 degrees, thus providing excellent coverage of large areas.

**Duplex** - See *Full-duplex*.

**DVD (Digital Versatile Disc)** - An optic disc with the same physical size as a CD, but with significantly greater storage capacity.

**DVR (Digital Video Recorder)** - A DVR records analog video to a hard disk in digital format. Most DVRs use the MPEG-2 format for encoding analog video signals.

**Encoder** - See *Video encoder*.

**Ethernet** - Ethernet is the most widely installed local area network technology. An Ethernet LAN typically uses special grades of twisted pair wires. The most commonly installed Ethernet systems are 10BASE-T and 100BASE-T10, which provide transmission speeds up to 10 Mbps and 100 Mbps respectively.

**ETRAX (Ethernet Token Ring AXIS)** - The ETRAX chip is the cornerstone of Axis technology and the 'brain' in nearly all Axis products. A multipurpose Linux chip with integrated Ethernet networking and extremely flexible I/O options.

**Factory default settings** - These are the settings that originally applied for a device when it was first delivered from the factory. If it should become necessary to reset a device to its factory default settings, this will, for many devices, completely reset any settings that were changed by the user.

**Firewall** - A firewall works as a barrier between networks, e.g. between a Local Area Network and the Internet. The firewall ensures that only authorized users are allowed to access the one network from the other. A firewall can be software running on a computer, or it can be a standalone hardware device.

**Fixed dome network camera** - This type of camera cannot be remotely controlled as regards movement, but is mounted in the same type of dome as a controllable network dome camera. This camera must be positioned manually to provide the required coverage.

**Fixed network camera** - This type of camera cannot be remotely controlled as regards movement. It must be positioned manually to provide the required coverage.

**Fixed iris** - See *Autoiris*.

**Focal length** - Measured in millimeters, the focal length of a camera lens determines the width of the horizontal field of view, which in turn is measured in degrees.

**FTP (File Transfer Protocol)** - FTP is an application protocol that uses the TCP/IP protocols, used to exchange files between computers/devices on networks.

**Frame** - A frame is a complete video image. In the 2:1 interlaced scanning format of the RS-170 and CCIR formats, a frame is made up of two separate fields of 262.5 or 312.5 lines interlaced at 60 or 50 Hz to form a complete frame, which appears at 30 or 25 Hz. In video cameras with a progressive scan, each frame is scanned line-by-line and not interlaced; most are also displayed at 30 and 25 Hz.

**Frame rate** - The frame rate used to describe the frequency at which a video stream is updated is measured in frames per second (fps). A higher frame rate is advantageous when there is movement in the video stream, as it maintains image quality throughout.

**Full-duplex** - Transmission of data in two directions simultaneously. In an audio system this would describe e.g. a telephone systems. Half-duplex also provides bi-directional communication, but only in one direction at a time, as in a walkie-talkie system. See also *Simplex*.

**G.711** - The international standard for encoding telephone audio on a 64 kbps channel. It is a pulse code modulation (PCM) scheme operating at 8 kHz sample rate.

**G.726** - A frequently used speech-compression algorithm in telecommunications due to its high perceived speech quality and low resource requirements.

**Gain** - Gain is the amplification factor and the extent to which an analog amplifier boosts the strength of a signal. Amplification factors are usually expressed in terms of power. The decibel (dB) is the most common way of quantifying the gain of an amplifier.

**Gateway** - A gateway is a point in a network that acts as an entry point to another network. In a corporate network for example, a computer server acting as a gateway often also acts as a proxy server and a firewall server. A gateway is often associated with both a router, which knows where to direct a given packet of data that arrives at the gateway, and a switch, which furnishes the actual path in and out of the gateway for a given packet.

**GIF (Graphics Interchange Format)** - GIF is one of the most common file formats used for images in web pages. There are two versions of the format, 87a and 89a. Version 89a supports animations, i.e. a short sequence of images within a single GIF file. A GIF89a can also be specified for interlaced presentation.

**GOV (Group Of VOPs)** - A group of VOPs is the basic unit of an MPEG-4 video stream. The GOV contains different types and numbers of VOPs (I-VOPs, P-VOPs) as determined by the GOV length and GOV structure. See also *VOP*.

**GOV length** - The GOV length determines the number of images (VOPs) in the GOV structure. See also *GOV* and *VOP*.

**GOV structure** - The GOV structure describes the composition of an MPEG-4 video stream, as regards the

type of images (I-VOPs or P-VOPs) included in the stream, and their internal order. See also *GOV* and *VOP*.

**Half-duplex** - See *Full-duplex*.

**HTML (Hypertext Markup Language)** - HTML is the set of "markup" symbols or codes inserted in a file intended for display in web browser. The markup tells the browser how to display the page's words and images for the user.

**HTTP (Hypertext Transfer Protocol)** - HTTP is the set of rules for exchanging files (text, graphic images, sound, video, and other multimedia files) on the web. The HTTP protocol runs on top of the TCP/IP suite of protocols.

**HTTPS (Hypertext Transfer Protocol over SSL)** - HTTPS is a protocol used by web browsers and servers to encrypt and decrypt user page requests and the pages returned by the server. The encrypted exchange of information is governed by the use of an HTTPS certificate (issued by a Certificate Authority), which guarantees the authenticity of the server.

**Hub** - A (network) hub is used to connect multiple devices to the network. The hub transmits all data to all devices connected to it, whereas a switch will only transmit the data to the device it is specifically intended for.

**IEEE 802.11** - A family of standards for wireless LANs. The 802.11a standard supports 1 or 2 Mbit/s transmission on the 5 GHz band. IEEE 802.11b supports data rates up to 11 Mbit/s on the 2.4 GHz band, while 802.11g allows up to 54 Mbit/s on the 2.4 GHz band.

**Image compression** - Image compression minimizes the file size (in bytes) of an image. Two of the most common compressed image formats are JPEG and GIF. See also *MPEG* and *Motion JPEG*.

**Interlacing** - Interlaced video is video captured at 50 pictures (known as fields) per second, of which every 2 consecutive fields (at half height) are then combined into 1 frame. Interlacing was developed many years ago for the analog TV world and is still used widely today. It provides good results when viewing motion in standard TV pictures, although there is always some degree of distortion in the image.

To view interlaced video on e.g. a computer monitor, the video must first be de-interlaced, to produce progressive video, which consists of complete images, one after the other, at 25 frames per second. See also *Progressive scan*.

**IP (Internet Protocol)** - The Internet Protocol is a method transmitting data over a network. Data to be sent is divided into individual and completely independent "packets." Each computer (or host) on the Internet has at least one address that uniquely identifies it from all others, and each data packet contains both the sender's address and the receiver's address.

The Internet Protocol ensures that the data packets all arrive at the intended address. As IP is a connectionless protocol, which means that there is no established

connection between the communication end-points, packets can be sent via different routes and do not need to arrive at the destination in the correct order.

Once the data packets have arrived at the correct destination, another protocol - Transmission Control Protocol (TCP) - puts them in the right order. See also *TCP*.

**IP address** - An IP address is simply an address on an IP network used by a computer/device connected to that network. IP addresses allow all the connected computers/devices to find each other and to pass data back and forth.

To avoid conflicts, each IP address on any given network must be unique. An IP address can be assigned as fixed, so that it does not change, or it can be assigned dynamically (and automatically) by DHCP.

An IP address consists of four groups (or quads) of decimal digits separated by periods, e.g. 130.5.5.25. Different parts of the address represent different things. Some part will represent the network number or address, and some other part will represent the local machine address. See also *IP (Internet Protocol)*.

**Infrared (IR)** - Infrared radiation is radiation at a longer wavelength than visible light, which means it cannot be seen by the naked human eye. As infrared radiation can be detected as heat, this can be shown on a screen or captured by a digital camera, with hotter objects showing up brighter against colder surroundings (e.g. a human body against a colder background).

As color cameras can "see" infrared radiation as well as visible light, these cameras are equipped with an IR-cut filter, to prevent distortion of the colors the human eye can see. To use the camera in very dark locations or at night, this filter can be removed, to allow infrared radiation to hit the image sensor and thus produce images. An infrared lamp can be used for improved illumination for night surveillance, while not producing any extra visible light.

**Inputs/Outputs (I/Os)** - The digital I/Os on, for example, a network camera can be used to connect any device that can toggle between an open and a closed circuit.

For example, if a door switch is used as an input device, opening the door could trigger the upload of video images and the sending of notification messages.

An output might, for example, be used to automatically start a siren when there is a motion detection trigger.

**ISMA (Internet Streaming Media Alliance)** - ISMA's goal is: "To accelerate the adoption and deployment of open standards for streaming rich media content such as video, audio, and associated data, over Internet protocols."

**I-VOP** - See *VOP*.

**JPEG (Joint Photographic Experts Group)** - Together with the GIF file format, JPEG is an image file type commonly used on the web. A JPEG image is a bitmap, and usually has the file suffix '.jpg' or '.jpeg.' When creating a JPEG image, it is possible to configure the level of compression to use. As the lowest compression (i.e. the highest quality) results in the largest file, there is a trade-off between image quality and file size.

**kbit/s (kilobits per second)** - A measure of the bit rate, i.e. the rate at which bits are passing a given point. See also *Bit rate*.

**LAN (Local Area Network)** - A LAN is a group of computers and associated devices that typically share common resources within a limited geographical area.

**Linux** - Linux is an open source operating system within the Unix family. Because of its robustness and availability, Linux has won popularity in the open source community and among commercial application developers.

**Lux** - A standard unit of illumination measurement.

**MAC address (Media Access Control address)** - A MAC address is a unique identifier associated with a piece of networking equipment, or more specifically, its interface with the network. For example, the network card in a computer has its own MAC address.

**Manual iris** - This is the opposite of an autoiris, i.e. the camera iris must be adjusted manually to regulate the amount of light allowed to reach the image sensor.

**Mbit/s (Megabits per second)** - A measure of the bit rate, i.e. the rate at which bits are passing a given point. Commonly used to give the "speed" of a network. A LAN might run at 10 or 100 Mbit/s. See also *Bit rate*.

**Monitor** - A monitor is very similar to a television set, but lacks the electronics to pick up regular television signals.

**Motion JPEG** - Motion JPEG is a simple compression/decompression technique for network video. Latency is low and image quality is guaranteed, regardless of movement or complexity of the image. Image quality is controlled by adjusting the compression level, which in turn provides control over the file size, and thereby the bit rate.

High-quality individual images from the Motion JPEG stream are easily extracted. See also *JPEG* and *GIF*.

**Megapixel** - See *Pixel*.

**MPEG (Moving Picture Experts Group)** - The Moving Picture Experts Group develops standards for digital video and audio compression. It operates under the auspices of the International Organization for Standardization (ISO). The MPEG standards are an evolving series, each designed for a different purpose.

**MPEG-2** - The designation for a group of audio and video coding standards, and is typically used to encode audio and video for broadcast signals, including digital satellite and Cable TV. MPEG-2, with some modifications, is also the coding format used by standard commercial DVD movies.

**MPEG-4** - MPEG-4 is a group of audio and video coding standards and related technology. The primary uses for the MPEG-4 standard are web (streaming media) and CD distribution, conversational (videophone), and broadcast television.

Most of the features included in MPEG-4 are left to individual developers to decide whether to implement them or not. This means that there are probably no complete implementations of the entire MPEG-4 set of standards. To deal with this, the standard includes the concept of "profiles" and "levels", allowing a specific set of capabilities to be defined in a manner appropriate for a subset of applications.

**Multicast** - Bandwidth-conserving technology that reduces bandwidth usage by simultaneously delivering a single stream of information to multiple network recipients. See also *Unicast*.

**Multiplexer** - A multiplexer is a high-speed switch that provides full-screen images from up to 16 analog cameras. Multiplexers can playback everything that happened on any one camera with no interference from the other cameras on the system.

**Network camera (Network video camera)** - A network camera is a camera and computer combined in one intelligent unit. It captures and sends live video directly over an IP network such as a LAN, intranet or the Internet. Users can view and/or manage the camera using a web browser or application software from any local or remote computer on a network. The camera allows multiple authorized viewers from different locations to simultaneously access images. A network camera is sometimes known as an IP camera.

**Network connectivity** - The physical (wired or wireless) and logical (protocol) connection of a computer network or an individual device to a network, such as the Internet or a LAN.

**Network video** - Network video (often referred to as IP-Surveillance for specific applications within security surveillance and remote monitoring) is a system that gives users the ability to monitor and record video over an IP network (LAN/WAN/Internet).

**NTSC (National Television System Committee)** - NTSC is an analog color encoding system used in television systems in Japan, the United States and other parts of the Americas. NTSC defines the video signal using 525 TV lines per frame, at a refresh rate equal to 30 frames per second. See also *PAL*.

**NVR (Network Video Recorder)** - A dedicated Network Video Recorder (NVR) can be used to gather data streams from remote network cameras and video servers and store them on a hard disk. An NVR can be a standard networked PC, or a dedicated video recording hard disk server with its own software application.

**OEM (Original Equipment Manufacturer)** - This is a designation for companies that manufacture equipment that is then marketed and sold to other companies under their own names.

**PAL (Phase Alternating Line)** - PAL is an analog color encoding system used in television systems in Europe and in many other parts of the world. PAL defines the video signal using 625 TV lines per frame, at a refresh rate equal to 25 frames per second. See also *NTSC*.

**PDA (Personal Digital Assistant)** - A small handheld computer, which usually provides at least a calendar, an organizer and a notepad.

**PEM (Privacy Enhanced Mail)** - An early standard for securing electronic mail. The PEM-format is often used for representing an HTTPS certificate or certificate request.

**Ping** - Ping is a basic network program used diagnostically to check the status of a network host or device. Ping can be used to see if a particular network address (IP address or host name) is occupied or not, or if the host at that address is responding normally. Ping can be run from e.g. the Windows Command prompt or the command line in Unix.

**Pixel (Picture Element)** - A pixel is one of the many tiny dots that make up a digital image. The color and intensity of each pixel represents a tiny area of the complete image.

**PoE (Power over Ethernet)** - Power over Ethernet provides power to a network device via the same cable as used for the network connection. This is very useful for IP-Surveillance and remote monitoring applications in places where it may be too impractical or expensive to power the device from a power outlet.

**PPP (Point-to-Point Protocol)** - A protocol that uses a serial interface for communication between two network devices. For example, a PC connected by a phone line to a server.

**PPTP (Point-to-Point Tunneling Protocol)** - A protocol (set of communication rules) that allows corporations to extend their own corporate network through private "tunnels" over the public Internet. In this way a corporation can effectively use a WAN (Wide Area Network) as a large single LAN (Local Area Network). This kind of interconnection is known as a virtual private network (VPN).

**Pre/post alarm images** - The images from immediately before and after an alarm. These images are stored in a buffer for later retrieval.

**Progressive scan** - Progressive scan, as opposed to interlaced video, scans the entire picture, line by line every sixteenth of a second. In other words, captured images are not split into separate fields as in interlaced scanning.

Computer monitors do not need interlace to show the picture on the screen, but instead show them progressively, on one line at a time in perfect order i.e. 1, 2, 3, 4, 5, 6, 7 etc., so there is virtually no "flickering" effect. In a surveillance application, this can be critical when viewing detail within a moving image, such as a person running. A high-quality monitor is required to get the best from progressive scan. See also *Interlacing*.

**Protocol** - A special set of rules governing how two entities will communicate. Protocols are found at many levels of communication, and there are hardware protocols and software protocols.

**Proxy server** - In an enterprise that uses the Internet, a proxy server acts as an intermediary between a workstation user and the Internet. This provides security, administrative control, and a caching service. Any proxy server associated with a gateway server, or part of a gateway server, effectively separates the enterprise network from the outside network and the local firewall. It is the firewall server that protects the enterprise network from outside intrusion.

**PTZ (Pan Tilt Zoom)** - A PTZ-enabled camera can be remotely controlled so as to change the view from the camera. Panning is the movement of the camera along its horizontal axis, tilting is the movement of the camera along its vertical axis, and zooming is the adjustment of the zoom lens to magnify the view.

**P-VOP** - See *VOP*.

**Quad view** - A Quad view displays images from up to four cameras on a single screen; where the images from each camera take up approximately a quarter of the display area.

**Remote monitoring** - Network video gives users the ability to gather information at all key points of an operation and view it in realtime. This makes the technology ideal for monitoring equipment, people and places, both locally and remotely. Application examples include traffic and production line monitoring, and the monitoring of multiple store locations.

**Resolution** - Image resolution is a measure of how much detail a digital image can hold: the greater the resolution, the greater the level of detail. Resolution can be specified as the number of pixel-columns (width) by the number of pixel-rows (height), e.g. 320x240.

Alternatively, the total number of pixels (usually in megapixels) in the image can be used. In analog systems it is also common to use other format designations, such as CIF, QCIF, 4CIF, etc.



**RS-232** - A long-established standard that describes the physical interface and protocol for low-speed serial data communication between devices. This is the interface that e.g. a computer uses to talk to and exchange data with a modem and other serial devices.

**RS-422** - A serial data communication protocol that specifies 4-wire, full-duplex, differential line, multi-drop communications. It provides balanced data transmission with unidirectional/non-reversible, terminated or non-terminated transmission lines. RS-422 does not allow multiple drivers, only multiple receivers. Maximum recommended range is 4,000 feet (1200 meters). Maximum recommended baud rate is 10Mbit/s.

**RS-485** - An upgraded version of RS-422 that supports up to 32 devices on the same connection. RS-485 is an electrical specification of a two-wire, half-duplex, multipoint serial connection. It enables the configuration of inexpensive local networks and multidrop communications links. It offers high data transmission speeds (up to 10Mbit/s), and as it uses a differential balanced line over twisted pair (like RS-422), it can span relatively large distances (4000 feet or 1200 meters). RS-485 only specifies the electrical characteristics of the driver and the receiver. It does not specify or recommend any data protocol.

**RTCP (Real-Time Control Protocol)** - RTCP provides support for real-time conferencing of groups of any size within an intranet. This support includes source identification and support for gateways like audio and video bridges as well as multicast-to-unicast translators. It offers quality-of-service feedback from receivers to the multicast group as well as support for the synchronization of different media streams.

**RTP (Real-Time Transport Protocol)** - An Internet protocol for the transport of real-time data, e.g. audio and video. It can be used for media-on-demand as well as interactive services such as Internet telephony.

**RTSP (Real Time Streaming Protocol)** - A control protocol, and a starting point for negotiating transports such as RTP, multicast and Unicast, and for negotiating codecs. RTSP can be considered a "remote control" for controlling the media stream delivered by a media server. RTSP servers typically use RTP as the protocol for the actual transport of audio/video data.

**Router** - A device that determines the next network point to which a packet should be forwarded on its way to its final destination. A router creates and/or maintains a special routing table that stores information on how best to reach certain destinations. A router is sometimes included as part of a network switch. See also *Switch*.

**Security surveillance** - Network video's advanced functionality makes it highly suited to the applications involved in security surveillance. The flexibility of digital technology enhances security personnel's ability to

protect people, property and assets. Such systems are therefore an especially attractive option for companies currently using CCTV.

**Server** - In general, a server is a computer program that provides services to other computer programs in the same or other computers. A computer running a server program is also frequently referred to as a server. In practice, the server may contain any number of server and client programs. A web server is the computer program that supplies the requested HTML pages or files to the client (web browser).

**Sharpness** - This is the control of fine detail within a picture. This feature was originally introduced into color TV sets that used notch filter decoders. This filter took away all high frequency detail in the black and white region of the picture. The sharpness control attempted to put some of that detail back in the picture. Sharpness controls are mostly superfluous in today's high-end TVs. The only logical requirement for it nowadays is on a VHS machine.

**Simplex** - In simplex operation, a network cable or communications channel can only send information in one direction. See also *Full-duplex*.

**SMTP (Simple Mail Transfer Protocol)** - Used for sending and receiving e-mail. However, as it is "simple," it is limited in its ability to queue messages at the receiving end, and is usually used with one of two other protocols, POP3 or IMAP. These other protocols allow the user to save messages in a server mailbox and download them periodically from the server.

**SMTP authentication** - An extension of SMTP, where the client is required to log into the mail server before or during the sending of email. It can be used to allow legitimate users to send email while denying the service to unauthorized users, such as spammers.

**SNMP (Simple Network Management Protocol)** - SNMP forms part of the Internet Protocol suite, as defined by the Internet Engineering Task Force. The protocol can support monitoring of network-attached devices for any conditions that warrant administrative attention.

**Sockets** - Sockets are a method for communication between a client program and a server program over a network. A socket is defined as "the endpoint in a connection." Sockets are created and used with a set of programming requests or "function calls" sometimes called the sockets application programming interface (API).

**SSL/TSL**

**(Secure Socket Layer/Transport Layer Security)** - These two protocols (SSL is succeeded by TSL) are cryptographic protocols that provide secure communication on a network. SSL is commonly used over HTTP to form HTTPS, as used e.g. on the Internet for electronic financial transactions. SSL uses public key certificates to verify the

identity of the server.

**Subnet & subnet mask** - A subnet is an identifiably separate part of an organization's network. Typically, a subnet may represent all the machines at one geographic location, in one building, or on the same local area network (LAN). Having an organization's network divided into subnets allows it to be connected to the Internet with a single shared network address.

The subnet mask is the part of the IP address that tells a network router how to find the subnet that the data packet should be delivered to. Using a subnet mask saves the router having to handle the entire 32-bit IP address; it simply looks at the bits selected by the mask.

**Switch** - A network device that connects network segments together, and which selects a path for sending a unit of data to its next destination. In general, a switch is a simpler and faster mechanism than a router, which requires knowledge about the network and how to determine the route. Some switches include the router function. See also *Router*.

**TCP (Transmission Control Protocol)** - TCP is used along with the Internet Protocol (IP) to transmit data as packets between computers over the network. While IP takes care of the actual packet delivery, TCP keeps track of the individual packets that the communication (e.g. requested a web page file) is divided into, and, when all packets have arrived at their destination, it reassembles them to re-form the complete file.

TCP is a connection-oriented protocol, which means that a connection is established between the two end-points and is maintained until the data has been successfully exchanged between the communicating applications.

**Telnet** - Telnet is a simple method with which to access another network device, e.g. a computer. The HTTP protocol and the FTP protocols allow you to request specific files from remote computers, but do not allow you logon as a user of that computer. With Telnet, you log on as a regular user with whatever privileges you may have been granted for specific applications and data residing on that computer.

**Time-lapse recorder** - This type of video recorder is commonly used in the security industry and has the ability to record up to one week of video on a single tape. The most commonly used timing is the 24-hour mode. Having to change tapes only once a day and retaining large amounts of information are perceived as key advantages in using this particular mode of recording.

**TVL (TV Lines)** - A method of defining resolutions in analog video.

**UDP (User Datagram Protocol)** - UDP is a communications protocol that offers limited service for exchanging data in a network that uses the Internet Protocol (IP). UDP is an alternative to the Transmission

Control Protocol (TCP). The advantage of UDP is that it is not required to deliver all data and may drop network packets when there is e.g. network congestion. This is suitable for live video, as there is no point in re-transmitting old information that will not be displayed anyway.

**Unicast** - Communication between a single sender and a single receiver over a network. A new connection is established for each new user. See also *Multicast*.

**UPnP™** - A set of computer network protocols that allows the automatic peer-to-peer detection of devices on the network. UPnP is promoted by the UPnP Forum.

**URL (Uniform Resource Locator)** - An "address" on the network.

**USB (Universal Serial Bus)** - A plug-and-play interface between a computer and peripheral devices (scanners, printers)

**Varifocal lens** - A lens that provides a wide range of focal lengths, as opposed to a lens with a fixed focal length, which only provides one.

**Video camera** - See *Network camera* and *CCTV video camera*.

**Video decoder** - A network video decoder converts digital video and audio streams back into analog signals, which can then be displayed on standard TV sets, analog monitors and video switches.

**Video encoder (video server)** - A video encoder/server digitizes analog video signals and sends digital images directly over an IP network, such as a LAN, intranet or the Internet. In effect, it turns an analog video system into a network video system and enables users to view live images using a web browser or application software on any local or remote computer on a network.

**Video management software** - Video management software supplies the means for monitoring, analyzing and recording network video. In its simplest form, it offers live viewing, storage and retrieval of video sequences. Advanced applications may also provide support for recording of live video from multiple devices, different recording modes, search functions, remote access via a web browser, control of PTZ devices, etc.

**VMD (Video Motion Detection)** - Video Motion detection defines activity (motion) in a monitored scene by analyzing image data and differences in series of images. This detection can, for example, be used to trigger an alarm event in a network camera and start the upload of images from the camera.

**Video switcher** - An analog video switcher sequentially displays full screen images, from one camera after another, typically at 3-5 seconds intervals. Other camera sources are not recorded while the image source from one camera is displayed on screen.

**VPN (Virtual Private Network)** - This creates a secure "tunnel" between the points within the VPN. Only devices with the correct "key" will be able to work within the VPN. The VPN network can be within a company LAN (Local Area Network), but different sites can also be connected over the Internet in a secure way. One common use for VPN is for connecting a remote computer to the corporate network, via e.g. a direct phone line or via the Internet.

**VOP (Video Object Plane)** - A VOP is an image frame in an MPEG-4 video stream. There are several types of VOP:

- An I-VOP is a complete image frame.

- An P-VOP codes the differences between images, as long as it is more efficient to do so. Otherwise it codes the whole image, which may also be a completely new image.

**WAN (Wide-Area-Network)** - Similar to a LAN, but on a larger geographical scale.

**W-LAN (Wireless LAN)** - A wireless LAN is a wireless local area network that uses radio waves as its carrier: where the network connections for end-users are wireless. The main network structure usually uses cables.

**Web camera (Webcam)** - A camera that requires a constant connection (via e.g. USB) to a PC for its operation. See also *Network camera*.

**Web server** - A program that allows web browsers to retrieve files from computers connected to the Internet. The Web server listens for requests from browsers and upon receiving a request for a file sends it back to the browser. The primary function of a Web server is to serve pages to other remote computers.

**WEP (Wireless Equivalent Privacy)** - A wireless security protocol, specified in the IEEE 802.11 standard, which is designed to provide a wireless local area network (WLAN) with a level of security and privacy comparable to that usually expected of a wired LAN. Security is at two different levels; 40-bit and 128-bit encryption. The higher the bit number, the more secure the encryption.

**WINS (Windows Internet Naming Service)** - Part of the Microsoft Windows NT Server, WINS manages the association of workstation names and locations with IP addresses, without the user or administrator having to be involved in each configuration change.

**WPA-PSK (Wi-Fi Protected Access - Pre-Shared Key)** - This wireless encryption method uses a pre-shared key (PSK) for key management. Keys can usually be entered as manual hex values, as hexadecimal characters, or as a Passphrase. WPA-PSK provides a greater degree of security than WEP.

**Zoom lens** - A zoom lens can be moved (zoomed) to enlarge the view of an object to show more detail.



# Index

---

## A

- Action 39
- Action buttons 30
- Active/Inactive 11
- Administrators 17, 45
- Advanced TCP/IP settings 50
- Alarm 39, 43, 58
- Allowed IP addresses 45
- AMC Viewer Toolbar 12
- Anonymous viewers 45
- ARP/Ping 49
- Audio input 24
- Audio mode 23
- Audio output 25
- Audio settings 23
- Audio transmission 16
- AXIS Internet Dynamic DNS Service 50
- AXIS Media Control (AMC) 14

## B

- Backup 54
- Bandwidth 13, 71
- Basic TCP/IP settings 49
- Buffers 41

## C

- CGI links 30, 35
- Click-in-image 35
- COM Port RS-485 59
- Constant bit rate 13
- Control button 7, 56
- Customize 28

## D

- Date & Time 48
- DC power 58
- Digital input 58
- DIP switch 7
- DNS configuration 50

## E

- Email server 52
- Emergency recovery 62
- Enable ARP/Ping 49
- Event servers 39
- Event types 32
- External video 31
- External video sources 11

## F

- Factory default settings 56
- Frame rates 19, 70
- FTP server 39
- Full duplex 23, 24

## G

- Generic HTTP 59
- Generic TCP/IP 59

## H

- Half duplex 23, 24
- Host name 50
- HTML examples 30
- HTTP API 35
- HTTP API requests 30
- HTTP port number 51
- HTTP server 39
- HTTPS 46

## I

- I/O Ports 54
- I/O terminal connector 7
- Installing PTZ devices 32
- Internal video sources 11
- IP address filtering 45

## L

- Line Out 7
- Line/Mic In 7
- Live view config 27
- Live View page 17
- Logs & Reports 54

**M**

Maximum bandwidth 51  
Motion detection 42  
Motion JPEG 13, 16  
MPEG-4 13, 16  
MPEG-4 clients 16  
MPEG-4 protocols 14  
MPEG-4 settings 53  
Multicasting 14

**N**

Network settings 49  
Network traffic 51

**O**

Operators 46  
Output buttons 11  
Overlays 19  
Overview 5  
Own home page 29  
Own web files 28

**P**

Pan/Tilt/Zoom 34, 59  
Pinout - I/O connectors 58  
Port status 44  
Ports & Devices 53  
Post-trigger buffer 41  
Preset positions 36  
Pre-trigger buffer 41  
PTZ commands 30, 35  
PTZ control queue 37  
Pulse 11  
Push-to-talk 24

**Q**

QoS 52  
Quad stream 11, 20

**R**

Recovery 62  
Referrals 46  
Relative and absolute PTZ drivers 34

Restart 54

Restore 54

RS-232 connector 8

RS-485 58

RTP 14, 53

RTSP 14, 51

**S**

Scheduled event 39  
Security 45  
Sequence mode 11, 31  
Services 49  
Simplex 23  
SMTP settings 52  
Snapshot 11  
SOCKS server 52  
Specifications 66  
Streaming MPEG-4 14  
Support 54  
Synchronization 16  
System options 45

**T**

TCP server 39  
TCP/IP settings 49  
Transistor output 58  
Trigger buttons 11  
Triggered event 39  
Troubleshooting 61

**U**

UDP 14  
Unicasting 14  
Upgrade Server 54  
UPnP 53  
User-defined links 30  
Users 45

**V**

Variable bit rate 13  
Video input 7  
Video Output 7  
Video source 11, 19

Video streams 13, 15, 19