



Operator's Manual

THE POWER WITHIN™



Model 120000

Quantum

600 Series
625 Series
650 Series
675 Series



Quick Start Guide
on page 4

Safety References

The safety alert symbol  is used to identify safety information about hazards that can result in personal injury. A signal word (DANGER, WARNING, or CAUTION) is used with the alert symbol to indicate the likelihood and the potential severity of injury. In addition, a hazard symbol may be used to represent the type of hazard.

 **DANGER** indicates a hazard which, if not avoided, **will result in death or serious injury.**

 **WARNING** indicates a hazard which, if not avoided, **could result in death or serious injury.**

 **CAUTION** indicates a hazard which, if not avoided, **might result in minor or moderate injury.**

CAUTION, when used **without** the alert symbol, indicates a situation that **could result in damage to the engine.**



  This manual contains safety information to make you aware of the hazards and risks associated with engines. Because Briggs & Stratton does not necessarily know what equipment this engine will power, it is important that you read the instructions and the instructions for the equipment this engine powers.

Table of Contents

Safety	2
Features	3
QuickStart	4
Troubleshooting	6
READYSTART™	7
Starting	8
Operating & Stopping	9
Oil	10
Fuel	12
Fresh Start™ Fuel Cap	12
Specifications	13
Maintenance	14
Storage & Service	17
Warranty Information	18

SYMBOLS ASSOCIATED WITH THIS ENGINE:



Fire



Read Operating Manual



Explosion



Oil



Kickback



Fuel



Hot Surface



Fuel Shutoff



Toxic Fumes



On Off



Moving Parts



Run



Shock



Choke



Hazardous Chemical



Stop



Slow



Fast



WARNING

Briggs & Stratton does not approve or authorize the use of these engines on 3-wheel All Terrain Vehicles (ATVs), motor bikes, fun/recreational go-karts, aircraft products or vehicles intended for use in competitive events. Use of these engines in such applications could result in property damage, serious injury (including paralysis), or even death.



WARNING

The engine exhaust from this product contains chemicals known to the State of California to cause cancer, birth defects, or other reproductive harm.

CAUTION

This engine is shipped from Briggs & Stratton without oil. If you start the engine without oil, the engine will be damaged beyond repair and will not be covered under warranty.

Know Your Engine

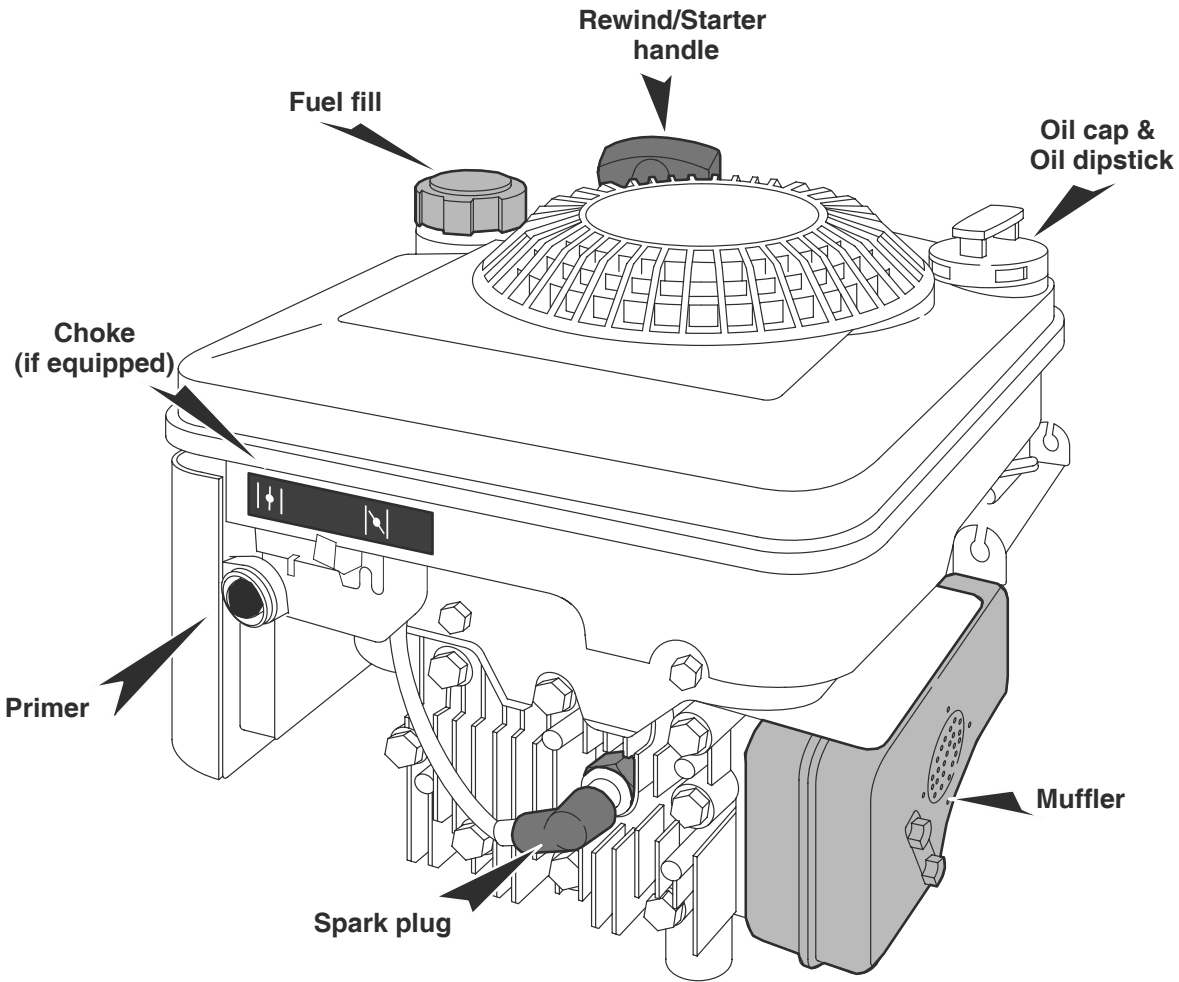

Front view

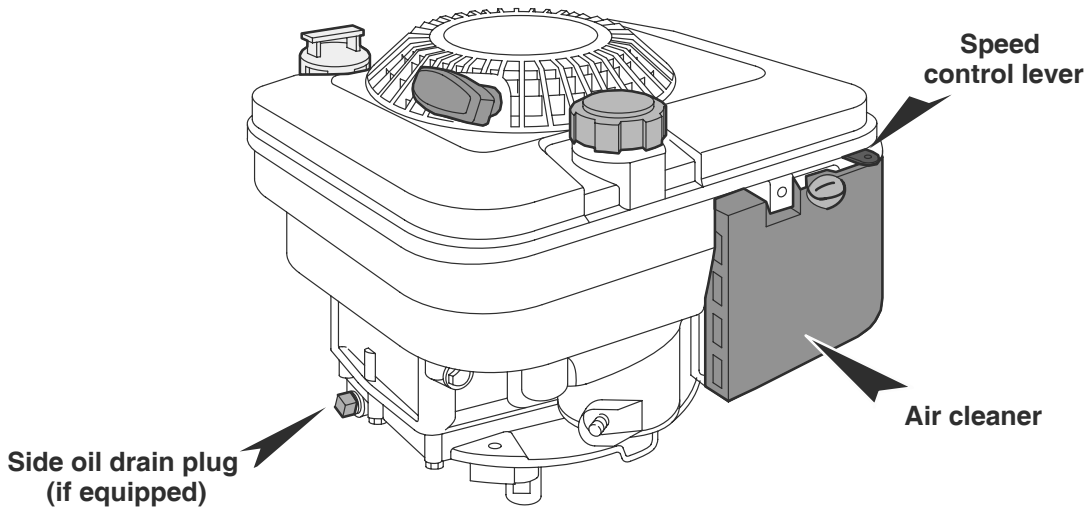

Back view



This manual contains safety information to make you aware of the hazards and risks associated with engines. Read the Operating Manual before starting your engine.

SIMPLE STEPS TO STARTING YOUR ENGINE ...

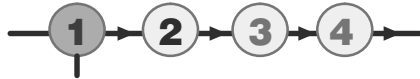

ADD OIL

WHAT KIND?

High quality SAE 30 motor oil.

HOW MUCH?

To FULL line on dipstick.
Engine holds about 20 oz. (0.61l).

HOW?

Unscrew and remove oil cap.
Pour in oil. Replace cap.

SPECIAL CONCERNS?

Do not overfill.
Do not tip engine.



See page 10 for details.



WIPE DIPSTICK.
REPLACE DIPSTICK
AND TIGHTEN CAP.
REMOVE DIPSTICK
TO READ LEVEL.

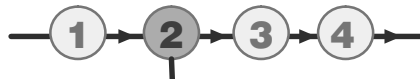

ADD GAS

WHAT KIND?

Unleaded, 85 octane or higher.

HOW MUCH?

Fill to one inch below top of fuel fill neck.

HOW?

Remove gas cap. Pour in gas. Replace cap.

SPECIAL CONCERNS?

Fuel equipment outdoors. If fuel spills, wait until it evaporates before starting engine.



See page 12 for details.



WARNING



Starting engine creates sparking. Gasoline and its vapors are extremely flammable and explosive. Fire or explosion can cause severe burns or death.



If fuel spills, wait until it evaporates before starting engine.

DO NOT use pressurized starting fluids.

 If **ReadyStart™** go to step 4.

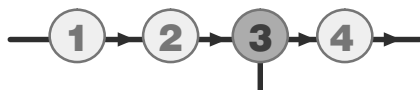

PUSH PRIMER

HOW MANY TIMES?

Press 5 times the **FIRST TIME** you start engine.
For all future starts, press 3 times.

HOW?

Locate primer bulb. Press with finger. Wait two seconds between each press.

SPECIAL CONCERNS?

Pressing primer too many times can flood engine with gas. A flooded engine will not start.
See *Troubleshooting* section.

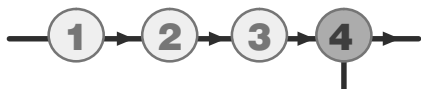

PULL STARTER HANDLE

HOW?

Stand behind equipment.
Close bail, or operator control bar, on equipment with this feature. If you do not keep bail held against equipment handle, engine will not start.
Slowly pull cord until you feel resistance, then pull quickly.

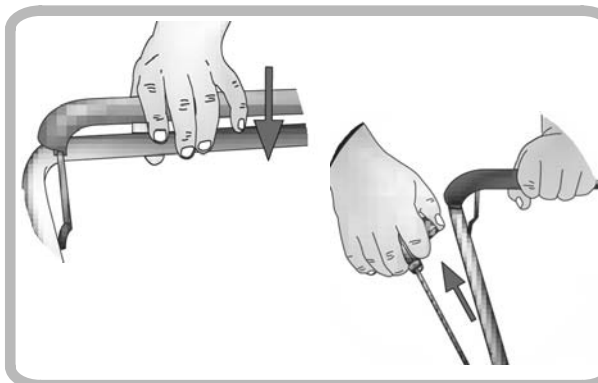

SPECIAL CONCERNS?

If speed control equipped, start in **FAST** position.
Also, see warning at right.

 If electric start equipped see page 8.

To Stop Engine –

Let go of bail, or operator control bar, which activates brake and stops engine from running.

 For complete starting instructions see page 8.

! WARNING



Rapid retraction of starter cord (kickback) will pull hand and arm toward engine faster than you can let go. To avoid kickback, slowly pull the cord until you feel resistance, then pull rapidly.

Broken bones, fractures, bruises or sprains could result.



Rotating parts can contact or entangle hands, feet, hair, clothing, or accessories.

Traumatic amputation or severe laceration can result.



Need assistance? 1-800-233-3723

(USA and Canada ONLY, Pre-recorded message.)

www.briggsandstratton.com

Troubleshooting

Starter Handle will not pull.

- ◆ **The bail, operator control bar, is not engaged which releases the brake from the flywheel allowing the engine to turn over.**
- ◆ **Place equipment on flat level surface.**
 - Ensure all external equipment/engine loads are removed before starting engine. Direct coupled equipment components must be securely attached such as, but not limited to, blades, impellers, pulleys, sprockets, etc.



Engine will not start.

- ◆ **Oil Level is OVER FULL mark on dipstick.**
 - Drain excess oil from engine to bring level to FULL mark on dipstick.
 - Check air cleaner filter for oil saturation. If saturated, clean or replace filter.
- ◆ **Out of Fuel**
 - Add gasoline.
 - Prime engine.
- ◆ **Engine Flooded**
 - Set choke (if equipped) to OPEN/RUN position, place throttle (if equipped) in FAST and continue to pull starter handle.
- ◆ **Spark Plug Fouling**
 - Remove spark plug. Clean, check gap, replace. See *Maintenance* section.

CAUTION

DO NOT OVERFILL OIL. Overfilling may cause smoking, hard starting, spark plug fouling or oil saturation of air filter.

WARNING



- Ensure fuel cap, and air cleaner are in place before starting engine.
- Before refueling – turn engine OFF and let engine cool at least 2 minutes before removing gas cap.
- Check fuel lines, tank, cap, and fittings for cracks or leaks. Replace if necessary.
- Do not crank engine with spark plug removed.

Engine is Smoking or Running Rough.

- ◆ **Engine may have been tipped during transport.**
 - Check for fouled spark plug.
 - Check air cleaner filter for oil saturation. If saturated, clean or replace filter.

CAUTION

If engine is tipped to transport equipment, to remove debris, to drain oil, etc., **keep the spark plug side of engine up.**

KEEP SPARK PLUG UP

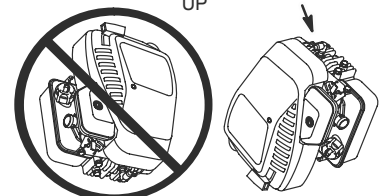

ReadyStart™ Instructions

1. Check oil level. Ensure level is at FULL mark on dipstick. Use a high quality motor oil. Check the oil recommendations for the correct oil type for expected starting temperature.



2. Move speed control to FAST, if equipped. Operate engine in FAST position.
3. Close bail, operator control bar on equipment with this feature.



4. Start your engine. See options below:

Rewind Start

- Grasp rope handle. Pull slowly until resistance is felt, then pull rapidly to start engine and avoid kickback.

WARNING



Electric Start

- Insert key and turn to START.
- Allow engine to warm up.

Go to Operating Engine on page 9.

WARNING



- Make sure spark plug, muffler, fuel cap and air cleaner are in place.
- Do not crank engine with spark plug removed.
- DO NOT start engine if there is a natural or LP gas leak in area.
- If there is natural or LP gas leakage in area, do not start engine.
- Do not use pressurized starting fluids because vapors are flammable.

WARNING



- Start and run engine outdoors.
- Do not start or run engine in enclosed area, even if doors or windows are open.

WARNING



Rapid retraction of starter cord (kickback) will pull hand and arm toward engine faster than you can let go. To avoid kickback, slowly pull the cord until you feel resistance, then pull rapidly.

Broken bones, fractures, bruises or sprains could result.

Rotating parts can contact or entangle hands, feet, hair, clothing, or accessories.

Traumatic amputation or severe laceration can result.

CAUTION

To prolong starter life use short starting cycles (5 seconds maximum, then wait one minute). Follow equipment manufacturer's recommendations for charging battery.

Starting Instructions

1. Check oil level. Ensure level is at FULL mark on dipstick. Use a high quality motor oil. Check the oil recommendations for the correct oil type for expected starting temperature.

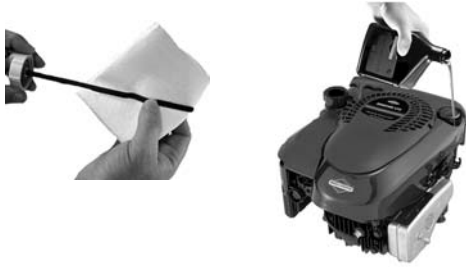

2. Open fuel shut-off valve 1/4 turn, if equipped.

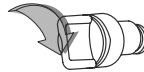

3. Firmly push primer bulb 3 times, if equipped.



4. Move speed control to FAST, if equipped. Operate engine in FAST position.

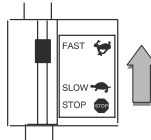

5. Close bail, operator control bar on equipment with this feature.



6. Start your engine. See options below:

Rewind Start

- Grasp rope handle. Pull slowly until resistance is felt, then pull rapidly to start engine and avoid kickback.

WARNING



Electric Start

- Insert key and turn to START.
- Allow engine to warm up.

WARNING



- Make sure spark plug, muffler, fuel cap and air cleaner are in place.
- Do not crank engine with spark plug removed.
- DO NOT start engine if there is a natural or LP gas leak in area.
- If there is natural or LP gas leakage in area, do not start engine.
- Do not use pressurized starting fluids because vapors are flammable.

WARNING



- Start and run engine outdoors.
- Do not start or run engine in enclosed area, even if doors or windows are open.

WARNING



Rapid retraction of starter cord (kickback) will pull hand and arm toward engine faster than you can let go. To avoid kickback, slowly pull the cord until you feel resistance, then pull rapidly.

Broken bones, fractures, bruises or sprains could result.

Rotating parts can contact or entangle hands, feet, hair, clothing, or accessories.

Traumatic amputation or severe laceration can result.

CAUTION

To prolong starter life use short starting cycles (5 seconds maximum, then wait one minute). Follow equipment manufacturer's recommendations for charging battery.

Operating Engine

After engine has started, let it warm up several seconds to several minutes, depending on outside temperature. For maximum performance and life, operate engine with speed control in FAST, if equipped.

- Do not tip engine or equipment at angle which causes gasoline to spill.

Periodically remove grass buildup under mower deck. See *Maintenance* section.

WARNING



Engines give off carbon monoxide, an odorless, colorless, poison gas.

Breathing carbon monoxide can cause nausea, fainting or death.

WARNING



Running engines produce heat. Engine parts, especially muffler, become extremely hot.

Severe thermal burns can occur on contact.



Combustible debris, such as leaves, grass, brush, etc. can catch fire.

- Allow muffler, engine cylinder and fins to cool before touching.
- Remove accumulated combustibles from muffler area and cylinder area.
- Install and maintain in working order a spark arrester before using equipment on forest-covered, grass-covered, brush-covered unimproved land. The state of California requires this (Section 4442 of the California Public Resources Code). Other states may have similar laws. Federal laws apply on federal land.

WARNING



- Operate equipment with guards in place.
- Keep hands and feet away from rotating parts.
- Tie up long hair and remove jewelry.
- Do not wear loose-fitting clothing, dangling drawstrings or items that could become caught.

Stopping Engine

Depending on how your engine is equipped follow the steps below:

1. Move speed control to SLOW then to STOP, then release bail – **OR** –
2. Push stop switch to OFF – **OR** –

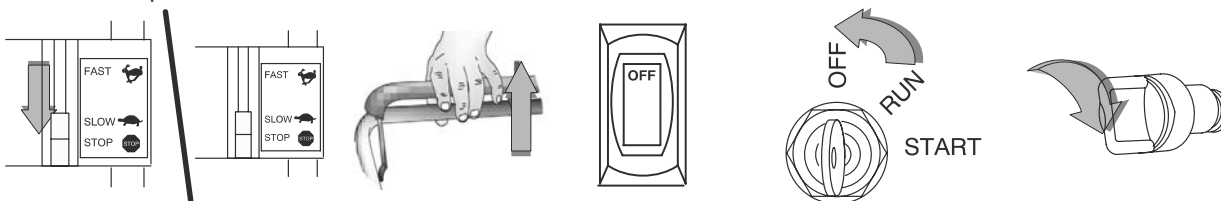

3. Turn key to OFF. Remove key and store out of reach of children.
4. Close fuel shut-off valve if equipped.

CAUTION

Do not stop engine by moving choke control to CHOKE (if equipped). Backfire, fire or engine damage could occur.

Oil Capacity

The engine holds approximately (18 oz.; 0.5 liter).

- Use a high quality SAE 30 weight motor oil.
- Do not use special additives.
- Choose a viscosity according to the table opposite.



Note: Synthetic oil meeting ILSAC GF-2, API certification mark and API service symbol (shown at left) with "SJ/CF ENERGY CONSERVING" or higher, is an acceptable oil at all temperatures. **Use of synthetic oil does not alter required oil change intervals.**

Recommendation

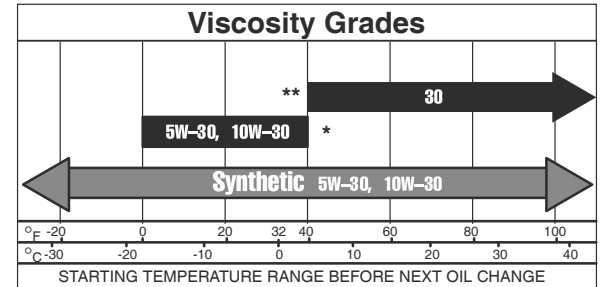

CAUTION

- * Air cooled engines run hotter than automotive engines. The use of non-synthetic multi-viscosity oils (5W-30, 10W-30, etc.) in temperatures above 40° F (4° C) will result in higher than normal oil consumption. When using a multi-viscosity oil, check oil level more frequently.
- ** 30 weight oil, if used below 40° F (4° C), will result in hard starting and possible engine bore damage due to inadequate lubrication.

Checking Oil Level

- Check oil level *before* starting the engine.
- Check level daily, or after every eight (8) hours.
- Keep oil level at FULL.

1. Place engine level and clean around oil fill area.
2. Remove dipstick and wipe clean with cloth.
3. Replace and tighten dipstick. Remove and check oil level. Oil level should be at FULL line on dipstick.
4. If needed, add oil slowly - recheck. Do not over fill.
5. Wipe dipstick clean, replace and tighten. Remove and check oil level. Oil level should be at FULL line on dipstick.

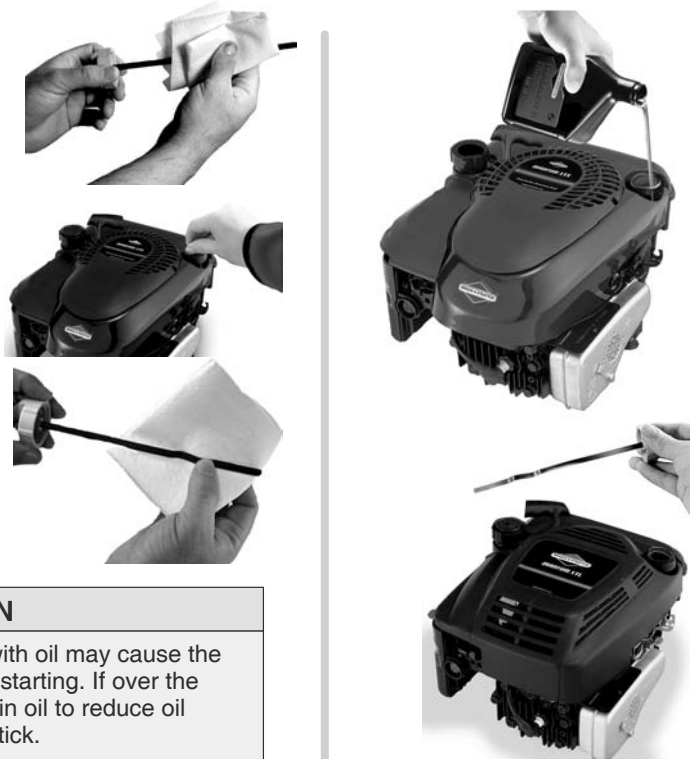

CAUTION

Do not overfill. Overfilling with oil may cause the engine to not start, or hard starting. If over the FULL mark on dipstick, drain oil to reduce oil level to FULL mark on dipstick.

Changing Oil

Change oil after first 5 to 8 hours of use, then every 50 hours or every season. Change oil every 25 hours when operating the engine under heavy load or in high temperatures.

1. Run engine until it runs out of fuel. Otherwise, fuel can leak out, creating a fire/explosion hazard, when you tip engine in Step 4.
2. Disconnect spark plug wire and keep it away from spark plug.
3. With engine OFF but still warm remove dipstick.
4. Top oil drain, keep spark plug side up. Bottom or side oil drain (if equipped), keep engine level. Drain oil into appropriate receptacle.

Note: Top oil drain is recommended method, however oil can drain from side (if equipped) or bottom as shown.

5. Place engine level. Add about (18 oz. or 0.5 liter) new oil. Fill to FULL line on dipstick. **Do not overfill.** Replace dipstick.
6. Replace spark plug wire before starting.

CAUTION

Used oil is a hazardous waste product. Dispose of used oil properly. Do not discard with household waste. Check with your local authorities, service center, or dealer for safe disposal/recycling facilities.

WARNING

On bottom oil drain, DO NOT rotate blade or any other parts unless spark plug wire is disconnected from spark plug.

DRAIN
PLUGS



PIPE



3/8"
SQUARE

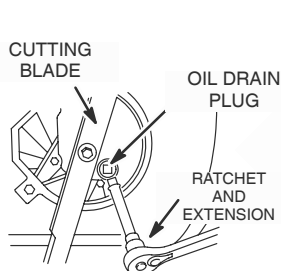

Bottom Oil Drain



Top Oil Drain

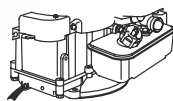

Side Oil Drain
(if equipped)



High Oil Fill
(if equipped)

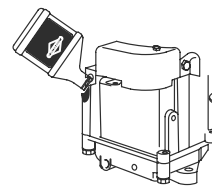

Low Oil Fill
(if equipped)

Fuel

Type to Use

- Use clean, fresh, regular unleaded gasoline with a minimum of 85 octane. Fresh fuel prevents gum from forming in the fuel system or on essential carburetor parts. Purchase fuel in quantity that can be used within 30 days.
- Do not use gasoline which contains Methanol.
- Do not mix oil with gasoline.
- For engine protection use Briggs & Stratton Gasoline Additive available from your Authorized Briggs & Stratton Dealer.
- This engine is certified to operate on gasoline. Exhaust Emission Control System: EM (Engine Modifications).

CAUTION

Some fuels, called oxygenated or reformulated gasoline, are gasoline blended with alcohols or ethers. Excessive amounts of these blends can damage the fuel system or cause performance problems. If any undesirable operating symptoms occur, use gasoline with a lower percentage of alcohol or ether.

Adding Fuel

1. Remove cap. Fill tank to approximately one inch below top of neck to allow for fuel expansion. Be careful not to overfill.
2. Replace cap before starting.



! WARNING



- Turn engine OFF and let engine cool at least 2 minutes before removing gas cap.
- Fill fuel tank outdoors or in well-ventilated area.
- Do not overfill fuel tank. Fill tank to approximately 1 inches below top of neck to allow for fuel expansion.
- If fuel spills, wait until it evaporates before starting engine.
- Keep gasoline away from sparks, open flames, pilot lights, heat, and other ignition sources.
- Check fuel lines, tank, cap, and fittings frequently for cracks or leaks. Replace if necessary.

Fresh Start™ Fuel Cap

Your engine may be equipped with a Fresh Start fuel cap.



Cartridge is shown with tab partially removed.

Fresh Start fuel cap is designed to hold a cartridge which contains fuel stabilizer.

1. Place silver foil seal end of cartridge into fuel cap.
2. Press to “snap” cartridge into place.
3. Remove the white tab to expose membrane.
4. Reinstall fuel cap on engine fuel tank.
5. Check periodically – if empty, remove and replace.

! DANGER



Contents are HARMFUL OR FATAL IF SWALLOWED. Avoid contact to eyes, skin, or clothing. Do not take internally. Avoid breathing the mist or vapor. Overexposure to eyes or skin can cause irritation. KEEP STABILIZER OUT OF THE REACH OF CHILDREN. Fuel stabilizer is a hazardous chemical.**

- IF SWALLOWED, call physician immediately. Do not induce vomiting. If inhaled, remove to fresh air. In case of eye or skin contact, flush with water for 15 minutes.
- Store unopened cartridges in a cool, dry, well-ventilated area. Keep open cartridge in fuel cap, and fuel cap closed on fuel tank when not in use.

** Fuel stabilizer contains: 2,6-di-tert-butylphenol (128-39-2) and aliphatic petroleum distillate (64742-47-8).

- *In case of emergency, contact a physician immediately and call 1-800-424-9300 for material safety information.*



Engine Specifications

This is a single cylinder, L-head, air-cooled engine. It is a low emissions engine.

In the state of California, model 120000 engine covered in this manual is certified by the California Air Resources Board to meet emissions standards for 125 hours. Such certification does not grant the purchaser, owner or operator of this engine any additional warranties with respect to the performance or operational life of this engine. This engine is warranted solely according to the product and emissions warranties stated elsewhere in this manual.

Model 120000

Bore 2-11/16 in. (68.26 mm)

Stroke 2-3/64 in. (51.99 mm)

Displacement 11.57 cu. in. (189.6cc)

Tune-up Specifications

Armature air gap .. 0.006 – 0.010 in. (0.15 – 0.25 mm)

Spark plug gap 0.030 in. (0.76 mm)

Valve clearance with valve springs installed and piston 1/4 in. (6 mm) past top dead center (check when engine is cold). See Repair Manual P/N 270962.

Intake 0.005 – 0.007 in. (0.13 – 0.18 mm)

Exhaust 0.007 – 0.009 in. (0.18 – 0.23 mm)

Note: For practical operation, the horsepower loading should not exceed 85% of rated horsepower. Engine power will decrease 3-1/2% for each 1,000 feet (300 meters) above sea level and 1% for each 10° F (5.6° C) above 77° F (25° C). It will operate satisfactorily at an angle up to 15°.

Model, Type and Code Number

To get replacement parts or technical assistance in the future write you engine Model, Type and Code number along with the date of purchase here. These numbers are located on your engine. For the location, see **Engine Features**.

Model

--	--	--	--	--	--	--	--

Type

--	--	--	--	--	--	--	--

Code

--	--	--	--	--	--	--	--	--	--

Month/Day/Year

--	--	--	--	--	--	--	--

Technical Information

Engine Power Rating Information

The gross power rating for individual gas engine models is labeled in accordance with SAE (Society of Automotive Engineers) code J1940 (Small Engine Power & Torque Rating Procedure), and rating performance has been obtained and corrected in accordance with SAE J1995 (Revision 2002-05). Actual gross engine power will be lower and is affected by, among other things, ambient operating conditions and engine-to-engine variability. Given both the wide array of products on which engines are placed and the variety of environmental issues applicable to operating the equipment, the gas engine will not develop the rated gross power when used in a given piece of power equipment (actual "on-site" or net horsepower). This difference is due to a variety of factors including, but not limited to, accessories (air cleaner, exhaust, charging, cooling, carburetor, fuel pump, etc.), application limitations, ambient operating conditions (temperature, humidity, altitude), and engine-to-engine variability. Due to manufacturing and capacity limitations, Briggs & Stratton may substitute an engine of higher rated power for this Series engine.

Emission Information

Engines that are certified to meet the California Air Resources Board (CARB) Tier 2 Emission Standards must display information regarding the Emissions Durability Period and the Air Index. Briggs & Stratton makes this information available to the consumer on our emission labels. The engine emission label will indicate certification information.

The **Emissions Durability Period** describes the number of hours of actual running time for which the engine is certified to be emissions compliant, assuming proper maintenance in accordance with the Operating & Maintenance Instructions. The following categories are used:

Moderate:

Engine is certified to be emission compliant for 125 hours of actual engine running time.

Intermediate:

Engine is certified to be emission compliant for 250 hours of actual engine running time.

Extended:

Engine is certified to be emission compliant for 500 hours of actual engine running time. For example, a typical walk-behind lawn mower is used 20 to 25 hours per year. Therefore, the **Emissions Durability Period** of an engine with an **intermediate** rating would equate to 10 to 12 years.

Certain Briggs & Stratton engines will be certified to meet the United States Environmental Protection Agency (USEPA) Phase 2 emission standards. For Phase 2 certified engines, the Emissions Compliance Period referred to on the Emissions Compliance label indicates the number of operating hours for which the engine has been shown to meet Federal emission requirements.

For engines less than 225 cc displacement.

Category C = 125 hours

Category B = 250 hours

Category A = 500 hours

For engines of 225 cc or more displacement.

Category C = 250 hours

Category B = 500 hours

Category A = 1000 hours.

Engine Maintenance

Regular maintenance will improve the performance and extend the life of the engine. See any Authorized Briggs & Stratton Dealer for service. **Use only genuine Briggs & Stratton parts. Other parts may not perform as well, may damage the engine, and may result in injury.** In addition, use of other parts may void your warranty.

Emission Control

Maintenance, replacement or repair of the emission control devices and systems may be performed by any nonroad engine repair establishment or individual. However, to obtain no charge repairs under the terms and provisions of the Briggs & Stratton warranty statement, any service or emission control part repair or replacement must be performed by a factory authorized dealer. See Emission Warranty section for details.

WARNING



Unintentional sparking can result in fire or electric shock.

Fire or explosion can cause severe burns or death.

Unintentional start-up can result in entanglement, traumatic amputation, or laceration.







Before performing maintenance:

- Disconnect spark plug wire and keep it away from spark plug.
- Disconnect battery at negative terminal (only engines with electric start).
- Do not strike the flywheel with a hammer or hard object because the flywheel may later shatter during operation.
- Do not tamper with governor spring, links or other parts to increase engine speed.
- Use only correct tools.

When testing for spark:

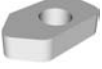
- Use approved spark plug tester.
- Do not check for spark with spark plug removed.

Follow the instructions and schedules indicated below.

Task <i>Perform task at hourly or calendar interval, whichever comes first.</i>	Every 8 Hours or Daily	25 Hours or Every Season	50 Hours or Every Season	100 Hours or Every Season	100-300 Hours
Check Oil Level					
Change Oil *					
Service foam air cleaner element **					
Replace spark plug					
Inspect spark arrester (if equipped)					
Clean air cooling system **					
Clean combustion chamber					

* **Change oil after first 5 to 8 hours of use**, then every 50 hours or every season. Change oil every 25 hours when operating the engine under heavy load or in high temperatures.

** Clean more often under dusty conditions or when airborne debris is present. Replace air cleaner parts, if very dirty.

*** On string trimmer applications:– clean debris at each refueling, sooner if needed (see **CLEANING DEBRIS** section);– have qualified technician clean air cooling system every 30 hours, every season, or sooner if needed, especially in high debris conditions (see **AIR COOLING SYSTEM** section).

Air Cleaner

All engines have an air cleaner cartridge. The cartridge is either flat or oval (see illustrations). In addition, some engines have a pre-cleaner.

Pre-cleaner

To clean pre-cleaner (if equipped), separate it from cartridge and wash in liquid detergent and water. Air dry thoroughly. Do not oil. Re-assemble dry pre-cleaner on clean cartridge.

Flat Air Cleaner

1. Loosen screw and tilt cover down.
2. Remove air filter.
3. Install new filter with the lip of pre-cleaner **1**, if equipped, at bottom of cartridge pleats. **2**
4. Insert cover's tabs into slots in bottom of base.
5. Tilt cover up into place and tighten screw.

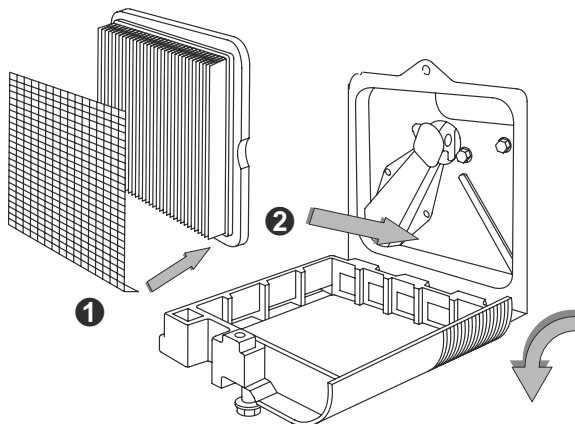
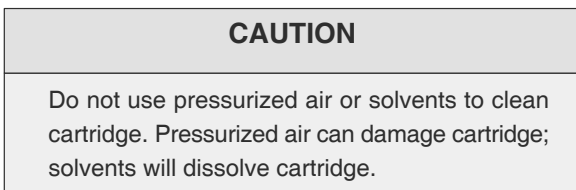

Oval Air Cleaner

1. Loosen two screws **1** and lift off cover.
2. Remove air cleaner cartridge **2** and pre-cleaner **3** if equipped, carefully from base to ensure no debris falls into engine.
3. Place new pre-cleaner on cartridge and re-install new cartridge assembly securely into base.
4. Place cover over air cleaner and tighten screws.

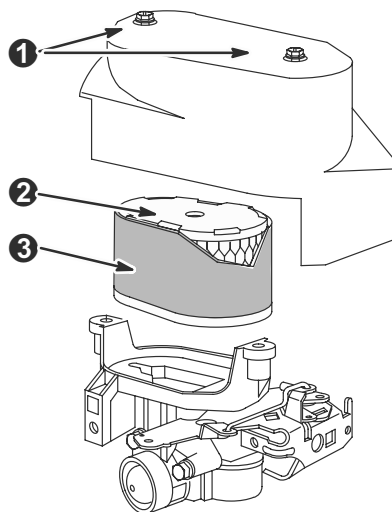

Spark Plug

Check the spark plug every 100 hours. Replace the spark plug if upon inspection the electrodes **1** are burned or worn. Ensure the spark plug is clean. Check the gap **2** with a feeler gage **3** and reset to .51 mm or 0.20 in. if necessary. Use only Briggs & Stratton Spark Tester (part number 19368) to check for spark.

Note: In some areas, local law requires using resistor spark plug to suppress ignition signals. If this engine was originally equipped with resistor spark plug, use same type for replacement.

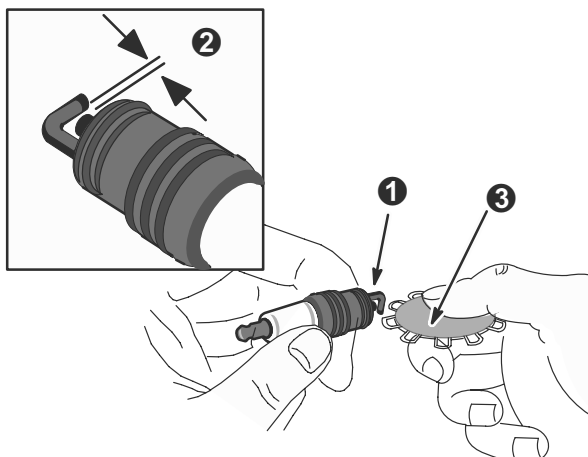

Combustion Deposits

We recommend that after every 100-300 hours you have an authorized Briggs & Stratton Service Dealer remove combustion deposits from the cylinder, cylinder head, top of piston, and around valves.

Muffler

Replacement parts for the muffler must be the same and installed in the same position as the original parts, otherwise fire can occur.



Fuel System

Drain fuel tank or close fuel shut-off valve before replacing fuel filter. Otherwise, fuel can leak out creating a fire/explosion hazard.

Replacement parts for fuel system (cap, hoses, tanks, filters, etc.) must be the same as original parts, otherwise fire can occur.



Air Cooling System

Over time debris may accumulate in cylinder cooling fins and cannot be observed without partial engine disassembly. For this reason, we recommend that you have an authorized Briggs & Stratton Service Dealer clean the air cooling system per recommended intervals. Equally important is to keep top of engine free from debris. See Cleaning Debris section.

Cleaning Debris

Daily or before every use, clean grass, chaff or accumulated debris from engine. Keep linkage, spring and controls clean. Keep area around and behind muffler free of any combustible debris. Keeping engine clean allows air movement around engine.

Engine parts should be kept clean to reduce the risk of overheating and ignition of accumulated debris. This is especially important if cutting tall grass.

On string trimmer applications clean accumulated debris at each refueling, sooner if needed.

Clean all areas shown below.

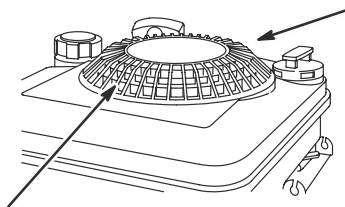
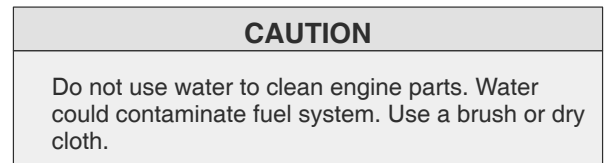

Finger Guard

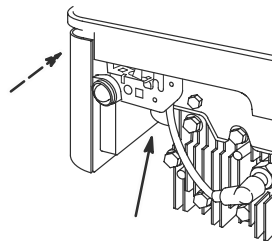

Linkage, Springs & Controls

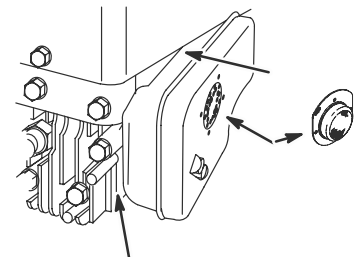

Muffler Area & Spark Arrester

Carburetor Adjustment

The carburetor on this engine is not adjustable.

Electric Start Engine

Follow equipment manufacturer's recommendation for charging battery.

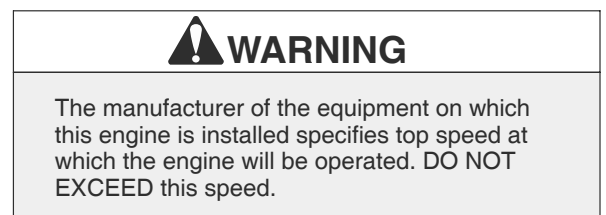

Storage

Engines stored over 30 days need special attention.

1. To prevent gum from forming in fuel system or on essential carburetor parts:
 - a) if fuel tank contains oxygenated or reformulated gasoline (gasoline blended with an alcohol or an ether), run engine until it stops from lack of fuel,
 - or b) if fuel tank contains gasoline, either run engine until it stops from lack of fuel, or add a gasoline additive to the gas in the tank. (See parts list. Single – use pouches of gas additive are available from your service dealer.) If you use a gas additive, run the engine for several minutes to circulate the additive through the carburetor. Then, engine and fuel can be stored up to 24 months.
2. While engine is still warm, change oil.
3. Remove spark plug and pour about 1/2 oz. (15 ml) of engine oil into cylinder. Replace spark plug and crank slowly to distribute oil.
4. Clean engine of surface debris, chaff or grass.
5. Store in a clean, dry area. Do not store in same area as a stove, furnace, water heater, or other appliance that uses a pilot light or has a device that can create a spark.

Service

See an Authorized Briggs & Stratton Service Dealer. Each one carries a stock of Genuine Briggs & Stratton Parts and is equipped with special service tools. Trained mechanics assure expert repair service on all Briggs & Stratton engines. Only dealers advertising as “Authorized Briggs & Stratton” are required to meet Briggs & Stratton standards. When you purchase equipment powered by a Briggs & Stratton engine, you are assured of highly skilled, reliable service at more than 30,000 Authorized Service Dealers worldwide, including more than 6,000 Master Service Technicians. Look for these signs wherever Briggs & Stratton service is offered.



You may locate your nearest Authorized Briggs & Stratton Service Dealer in our dealer locator map on our web site

www.briggsandstratton.com

or in the “Yellow Pages™” directory under “Engines, Gasoline” or “Gasoline Engines” or “Lawn Mowers” or similar category.



Note: Walking fingers logo and “Yellow Pages” are registered trademarks in various jurisdictions.

WARNING



When Transporting Equipment:

- Transport with fuel tank EMPTY or with fuel shut-off valve OFF.

When storing gasoline or equipment with fuel in tank:

- Store away from furnaces, stoves, water heaters, or other appliances that have a pilot light or other ignition source because they can ignite gasoline vapors.

PARTIAL LIST OF GENUINE BRIGGS & STRATTON PARTS

<u>PART</u>	<u>PART NO.</u>
Flat air cleaner cartridge	49158 –or– 5043
Flat air cleaner pre-cleaner	493537
Oval air cleaner cartridge	497725
Oval air pre-cleaner	273185
Oil	100005 –or– 100028
Fuel filter	298090 –or– 5018
Gas additive	5041
Resistor spark plug	802592
Standard spark plug	492167
Long life platinum spark plug	5062
(used on most L-head engines)	
Spark plug wrench	89838
Spark tester	19368
Oil pump kit	5056
(uses standard electric drill to remove oil from engine quickly)	

An illustrated shop manual includes common specifications and detailed information covering adjustment, tune-up and repair of Briggs & Stratton single cylinder, L-head, 4 cycle engines. It is available for purchase from an Authorized Briggs & Stratton Service Dealer or you can order it from

www.briggsandstratton.com

Warranty Information

Briggs & Stratton Corporation (B&S), the California Air Resources Board (CARB) and the United States Environmental Protection Agency (U.S. EPA) Emissions Control System Warranty Statement (Owner's Defect Warranty Rights and Obligations)

The California Air Resources Board (CARB), U.S. EPA and B&S are pleased to explain the Emissions Control System Warranty on your small off-road engine (SORE). In California, new small off-road engines model year 2006 and later must be designed, built and equipped to meet the State's stringent anti-smog standards.

Elsewhere in the United States, new non-road, spark-ignition engines certified for model year 1997 and later must meet similar standards set forth by the U.S. EPA. B&S must warrant the emissions control system on your engine for the

periods of time listed below, provided there has been no abuse, neglect or improper maintenance of your small off-road engine.

Your emissions control system includes parts such as the carburetor, air cleaner, ignition system, fuel line, muffler and catalytic converter. Also included may be connectors and other emissions related assemblies.

Where a warrantable condition exists, B&S will repair your small off-road engine at no cost to you including diagnosis, parts and labor.

Briggs & Stratton Emissions Control Defects Warranty Coverage

Small off-road engines are warranted relative to emissions control parts defects for a period of two years, subject to provisions set forth below. If any covered part on your engine is defective, the part will be repaired or replaced by B&S.

Owner's Warranty Responsibilities

As the small off-road engine owner, you are responsible for the performance of the required maintenance listed in your Operating and Maintenance Instructions. B&S recommends that you retain all your receipts covering maintenance on your small off-road engine, but B&S cannot deny warranty solely for the lack of receipts or for your failure to ensure the performance of all scheduled maintenance.

As the small off-road engine owner, you should however be aware that B&S may deny you warranty coverage if your small off-road engine or a part has failed due to abuse, neglect, improper maintenance or unapproved modifications.

You are responsible for presenting your small off-road engine to an Authorized B&S Service Dealer as soon as a problem exists.

The undisputed warranty repairs should be completed in a reasonable amount of time, not to exceed 30 days.

If you have any questions regarding your warranty rights and responsibilities, you should contact a B&S Service Representative at 1-414-259-5262.

The emissions warranty is a defects warranty. Defects are judged on normal engine performance. The warranty is not related to an in-use emissions test.

Briggs & Stratton Emissions Control Defects Warranty Provisions

The following are specific provisions relative to your Emissions Control Defects Warranty Coverage. It is in addition to the B&S engine warranty for non-regulated engines found in the Operating and Maintenance Instructions.

1. Warranted Parts

Coverage under this warranty extends only to the parts listed below (the emissions control systems parts) to the extent these parts were present on the engine purchased.

a. Fuel Metering System

- Cold start enrichment system
- Carburetor and internal parts
- Fuel Pump
- Fuel line, fuel line fittings, clamps
- Fuel tank, cap and tether
- Carbon canister

b. Air Induction System

- Air cleaner
- Intake manifold
- Purge and vent line

c. Ignition System

- Spark plug(s)
- Magneto ignition system

d. Catalyst System

- Catalytic converter
- Exhaust manifold
- Air injection system, Pulse valve

e. Miscellaneous Items

- Vacuum, temperature, position, time sensitive valves and switches
- Connectors and assemblies

2. Length of Coverage

B&S warrants to the initial owner and each subsequent purchaser that the Warranted Parts shall be free from defects in materials and workmanship which caused the failure of the Warranted Parts for a period of two years from the date the engine is delivered to a retail purchaser.

3. No Charge

Repair or replacement of any Warranted Part will be

performed at no charge to the owner, including diagnostic labor which leads to the determination that a Warranted Part is defective, if the diagnostic work is performed at an Authorized B&S Service Dealer. For emissions warranty service contact your nearest Authorized B&S Service Dealer as listed in the "Yellow Pages" under "Engines, Gasoline," "Gasoline Engines," "Lawn Mowers," or similar category.

4. Claims and Coverage Exclusions

Warranty claims shall be filed in accordance with the provisions of the B&S Engine Warranty Policy. Warranty coverage shall be excluded for failures of Warranted Parts which are not original B&S parts or because of abuse, neglect or improper maintenance as set forth in the B&S Engine Warranty Policy. B&S is not liable to cover failures of Warranted Parts caused by the use of add-on, non-original, or modified parts.

5. Maintenance

Any Warranted Part which is not scheduled for replacement as required maintenance or which is scheduled only for regular inspection to the effect of "repair or replace as necessary" shall be warranted as to defects for the warranty period. Any Warranted Part which is scheduled for replacement as required maintenance shall be warranted as to defects only for the period of time up to the first scheduled replacement for that part. Any replacement part that is equivalent in performance and durability may be used in the performance of any maintenance or repairs. The owner is responsible for the performance of all required maintenance, as defined in the B&S Operating and Maintenance Instructions.

6. Consequential Coverage

Coverage hereunder shall extend to the failure of any engine components caused by the failure of any Warranted Part still under warranty.

BRIGGS & STRATTON ENGINE OWNER WARRANTY POLICY

Effective September 1, 2006

LIMITED WARRANTY

Briggs & Stratton Corporation will repair or replace, free of charge, any part(s) of the engine that is defective in material or workmanship or both. Transportation charges on parts submitted for repair or replacement under this warranty must be borne by purchaser. This warranty is effective for and is subject to the time periods and conditions stated below. For warranty service, find the nearest Authorized Service Dealer in our dealer locator map at www.briggsandstratton.com, or by calling 1-800-233-3723, or as listed in the 'Yellow Pages™'.

THERE IS NO OTHER EXPRESS WARRANTY. IMPLIED WARRANTIES, INCLUDING THOSE OF MERCHANTABILITY AND FITNESS FOR A PARTICULAR PURPOSE, ARE LIMITED TO ONE YEAR FROM PURCHASE, OR TO THE EXTENT PERMITTED BY LAW ANY AND ALL IMPLIED WARRANTIES ARE EXCLUDED. LIABILITY FOR INCIDENTAL OR CONSEQUENTIAL DAMAGES ARE EXCLUDED TO THE EXTENT EXCLUSION IS PERMITTED BY LAW. Some states or countries do not allow limitations on how long an implied warranty lasts, and some states or countries do not allow the exclusion or limitation of incidental or consequential damages, so the above limitation and exclusion may not apply to you. This warranty gives you specific legal rights and you may also have other rights which vary from state to state and country to country.

WARRANTY TERMS **

Brand / Product Type	Consumer Use	Commercial Use
Vanguard™	2 years	2 years
Extended Life Series™	2 years	1 year
I/C®, Intek I/C®, Intek Pro™	2 years	180 days
Kerosene Fuel Operated Engines	1 year	90 days
All Other Briggs & Stratton Engines	2 years	90 days

** Engines used on Home Standby Generator applications are warranted under consumer use only. This warranty does not apply to engines on equipment used for prime power in place of a utility. **Engines used in competitive racing or on commercial or rental tracks are not warranted.**

The warranty period begins on the date of purchase by the first retail consumer or commercial end user, and continues for the period of time stated in the table above. "Consumer use" means personal residential household use by a retail consumer. "Commercial use" means all other uses, including use for commercial, income producing or rental purposes. Once an engine has experienced commercial use, it shall thereafter be considered as a commercial use engine for purposes of this warranty.

NO WARRANTY REGISTRATION IS NECESSARY TO OBTAIN WARRANTY ON BRIGGS & STRATTON PRODUCTS. SAVE YOUR PROOF OF PURCHASE RECEIPT. IF YOU DO NOT PROVIDE PROOF OF THE INITIAL PURCHASE DATE AT THE TIME WARRANTY SERVICE IS REQUESTED, THE MANUFACTURING DATE OF THE PRODUCT WILL BE USED TO DETERMINE THE WARRANTY PERIOD.

Briggs & Stratton Engines Are Made Under One Or More Of The Following Patents: Design D-247,177 (Other Patents Pending)

6,691,683	6,520,141	6,325,036	6,145,487	6,012,420	5,803,035	5,548,955	5,243,878	5,138,996	4,875,448	D 476,629
6,647,942	6,495,267	6,311,663	6,142,257	5,992,367	5,765,713	5,546,901	5,235,943	5,086,890	4,819,593	D 457,891
6,622,683	6,494,175	6,284,123	6,135,426	5,904,124	5,732,555	5,445,014	5,234,038	5,070,829	4,720,638	D 368,187
6,615,787	6,472,790	6,263,852	6,116,212	5,894,715	5,645,025	5,503,125	5,228,487	5,058,544	4,719,682	D 375,963
6,617,725	6,460,502	6,260,529	6,105,548	5,887,678	5,642,701	5,501,203	5,197,426	5,040,644	4,633,556	D 309,457
6,603,227	6,456,515	6,242,828	6,347,614	5,852,951	5,628,352	5,497,679	5,197,425	5,009,208	4,630,498	D 372,871
6,595,897	6,382,166	6,239,709	6,082,323	5,843,345	5,619,845	5,320,795	5,197,422	4,996,956	4,522,080	D 361,771
6,595,176	6,369,532	6,237,555	6,077,063	5,823,153	5,606,948	5,301,643	5,191,864	4,977,879	4,520,288	D 356,951
6,584,964	6,356,003	6,230,678	6,064,027	5,819,513	5,606,851	5,271,363	5,188,069	4,977,877	4,512,499	D 309,457
6,557,833	6,349,688	6,213,083	6,040,767	5,813,384	5,605,130	5,269,713	5,186,142	4,971,219	4,453,507	D 308,872
6,542,074	6,347,614	6,202,616	6,014,808	5,809,958	5,497,679	5,265,700	5,150,674	4,895,119	4,430,984	D 308,871

ABOUT YOUR ENGINE WARRANTY

Briggs & Stratton welcomes warranty repair and apologizes to you for being inconvenienced. Any Authorized Service Dealer may perform warranty repairs. Most warranty repairs are handled routinely, but sometimes requests for warranty service may not be appropriate. For example, warranty would not apply if engine damage occurred because of misuse, lack of routine maintenance, shipping, handling, warehousing or improper installation. Similarly, warranty is void if the serial number of the engine has been removed or the engine has been altered or modified.

If a customer differs with the decision of the Service Dealer, an investigation will be made to determine whether the warranty applies. Ask the Service Dealer to submit all supporting facts to his Distributor or the Factory for review. If the Distributor or the Factory decides that the claim is justified, the customer will be fully reimbursed for those items that are defective. To avoid misunderstanding which might occur between the customer and the Dealer, listed below are some of the causes of engine failure that the warranty does not cover.

Normal wear:

Engines, like all mechanical devices, need periodic parts service and replacement to perform well. Warranty will not cover repair when normal use has exhausted the life of a part or an engine.

Improper maintenance:

The life of an engine depends upon the conditions under which it operates, and the care it receives. Some applications, such as tillers, pumps and rotary mowers, are very often used in dusty or dirty conditions, which can cause what appears to be premature wear. Such wear, when caused by dirt, dust, spark plug cleaning grit, or other abrasive material that has entered the engine because of improper maintenance, is not covered by warranty.

This warranty covers engine related defective material and/or workmanship only, and not replacement or refund of the equipment to which the engine may be mounted. Nor does the warranty extend to repairs required because of:

1. PROBLEMS CAUSED BY PARTS THAT ARE NOT ORIGINAL BRIGGS & STRATTON PARTS.
2. Equipment controls or installations that prevent starting, cause unsatisfactory engine performance, or shorten engine life. (Contact equipment manufacturer.)
3. Leaking carburetors, clogged fuel pipes, sticking valves, or other damage, caused by using contaminated or stale fuel. (Use clean, fresh, lead-free gasoline and Briggs & Stratton Fuel Stabilizer, Part No. 5041.)
4. Parts which are scored or broken because an engine was operated with insufficient or contaminated lubricating oil, or an incorrect grade of lubricating oil (check oil level daily or after every 8 hours of operation. Refill when necessary and change at recommended intervals.) OIL GARD® may not shut down running engine. Engine damage may occur if oil level is not properly maintained. Read Operating & Maintenance Instructions.
5. Repair or adjustment of associated parts or assemblies such as clutches, transmissions, remote controls, etc., which are not manufactured by Briggs & Stratton.
6. Damage or wear to parts caused by dirt, which entered the engine because of improper air cleaner maintenance, re-assembly, or use of a non-original air cleaner element or cartridge. (At recommended intervals, clean and re-oil the Oil-Foam element or the foam pre-cleaner, and replace the cartridge.) Read Operating & Maintenance Instructions.
7. Parts damaged by over-speeding, or overheating caused by grass, debris, or dirt, which plugs or clogs the cooling fins, or flywheel area, or damage caused by operating the engine in a confined area without sufficient ventilation. (Clean fins on the cylinder, cylinder head and flywheel at recommended intervals.) Read Operating & Maintenance Instructions.
8. Engine or equipment parts broken by excessive vibration caused by a loose engine mounting, loose cutter blades, unbalanced blades or loose or unbalanced impellers, improper attachment of equipment to engine crankshaft, over-speeding or other abuse in operation.
9. A bent or broken crankshaft, caused by striking a solid object with the cutter blade of a rotary lawn mower, or excessive v-belt tightness.
10. Routine tune-up or adjustment of the engine.
11. Engine or engine component failure, i.e., combustion chamber, valves, valve seats, valve guides, or burned starter motor windings, caused by the use of alternate fuels such as, liquified petroleum, natural gas, altered gasolines, etc.

Warranty is available only through service dealers which have been authorized by Briggs & Stratton Corporation. your nearest Authorized Service Dealer is listed in the "Yellow Pages™" of your telephone directory under "Engines, Gasoline" or "Gasoline Engines," "Lawn Mowers," or similar category.