



Apple Multiple Scan 20 Display

Apple Multiple Scan 20 Display
Apple Multiple Scan 20 Display, Rev. B





Basics

Apple Multiple Scan 20 Display





Version Differences

Overview

The Apple Multiple Scan 20 Display and Apple Multiple Scan 20 Display Rev. B have the same overall appearance. However, the Rev. B version offers improved performance and better screen resolution.

To distinguish the two versions, check the last three digits of the serial number. The serial number for the Rev. B version ends in one of the following:

- 5B4
- 5J2
- 5JE
- 5JF





Multiple Scan 20 Display

Dot pitch 0.31 mm.

Multiple Scan 20 Display, Rev. B

Dot pitch 0.26 mm.

Requires Rev. B parts for Main Deflection Board, Microprocessor Controller Board, and Power Supply.

As you go through this manual, consider the information applicable to both versions unless specified otherwise.





Monitor Distortion

Overview

All large-screen monitors are susceptible to distortions caused by environmental conditions. These distortions are usually not visible on monitors with smaller screens.

Important: Even monitors set to factory specifications may appear distorted when set up in a new environment.

Common environmentally caused distortions are shown on this and the following cards. Always check first for environmental causes before attempting to exchange or adjust a monitor with a distorted raster.



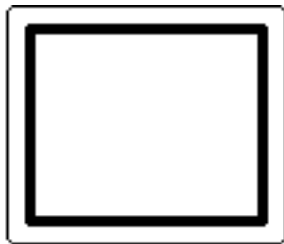

Ideal Raster



Raster Shifted Up and Left

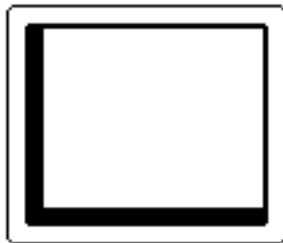

Raster Shifted Up and Right





Environmental Influences

The following environmental conditions may distort the raster:

- Proximity to metal objects, such as metal desks, file cabinets, and bookshelves. Metal objects affect the earth's magnetic field. Earth magnetism usually distorts only the edges of the screen.
- Fluorescent lights, other monitors, or electronic appliances such as coffee makers and copy machines. These objects cause dynamic raster distortion, that is, movement or jitter of the image.



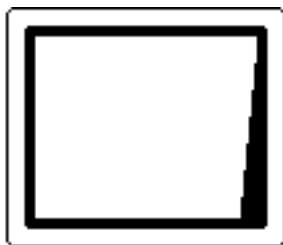

Right Edge Not Straight

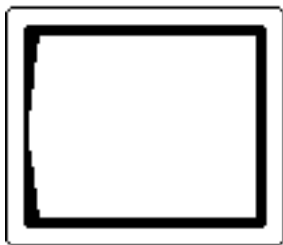

Left Side Bowed Out

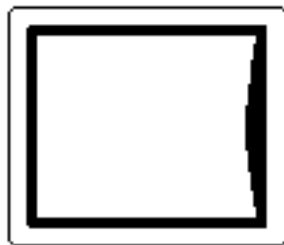

Right Side Bowed In





Troubleshooting

Important: Exchanging the monitor cannot correct environmental distortion problems.

Note: If the monitor has shifted up/down or right/left only, go ahead and adjust it using the user controls. However, keep in mind that if you then move the monitor you may need to readjust the centering controls.

Before adjusting a monitor with a distorted raster, try the following:

- Swivel or move the monitor, or
- Remove the monitor from the building and recheck it in another location.





If the display changes (for better or worse) when you move it to another location, the environment is the source of the problem. Relocate your monitor or remove the distortion-causing object.

If the display does not change when you move it to another location, continue troubleshooting the problem (refer to Troubleshooting).



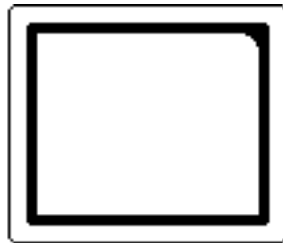

Upper-Right Corner Rounded

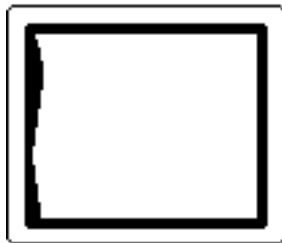

Left Edge S-Shaped



Raster Tilted Right





EEPROM Settings

Caution: To prevent data loss or corruption, always save EEPROM settings before you replace the microprocessor board.

See Troubleshooting for instructions on saving the EEPROM settings from the old microprocessor board and restoring the settings on the new microprocessor board.

If the settings are lost before they can be written to the new EEPROM, the display will be impossible to repair, and the whole display will need to be replaced.



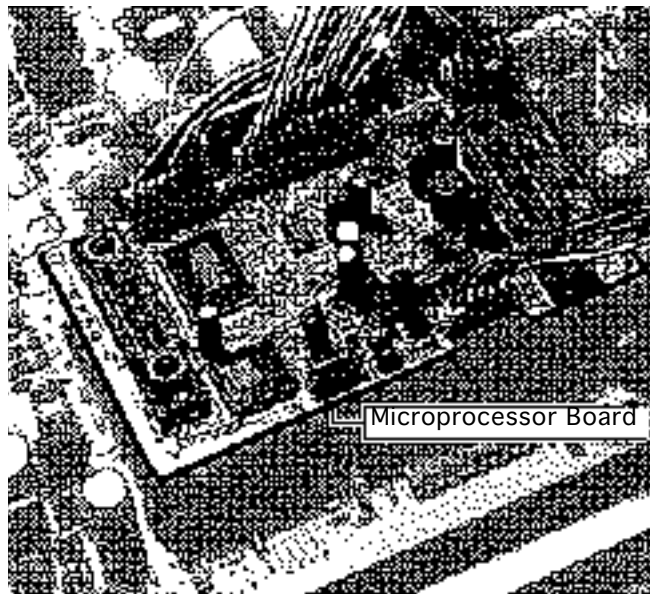



Specifications

Apple Multiple Scan 20 Display





Characteristics

Picture Tube

20-in. diagonal Trinitron CRT (19.1-in. viewable image)
Multiple scan
Bonded glass panel with antiglare/antistatic multilayer coating

Screen Resolution

640x480 to 1280x1024
0.31-mm stripe pitch
0.26-mm stripe pitch for Multiple Scan 20 Display, Rev. B

Scan Rates

Vertical refresh range: 50 to 150 Hz
Horizontal scan range: 29 to 82 kHz
Macintosh, VGA, SVGA, and VESA compatible

Cable Connector

15-pin miniature D-type





Video Input Signals

Video: red, green, and blue analog signals; RS-343A standard;.714 V peak to peak; positive going

Sync on green: RS-343A compatible level;.286 V \pm 10% negative-going during blanking intervals

Separate Sync: 1 to 5 V peak to peak; negative or positive going

Composite Sync: 1 to 5 V peak to peak; negative or positive going

System Requirements

Power Macintosh, Macintosh Centris, Macintosh Quadra, or any NuBus compatible Macintosh with a Macintosh Display Card 24AC.

Macintosh II family, PowerBooks, Duo and Mini Dock, Macintosh Performa, Macintosh LC, LC II, LC III, and Macintosh computers with Display Cards 4•8, 8•24, 8•24GC work in 640x480 mode. Other modes possible with additional adapters.
System software version 7.1 or later





Controls and Ports

User Controls

Front panel: power, reset, and control buttons; brightness and contrast controls

Additional controls available using the command button: horizontal and vertical shift, horizontal and vertical size, rotation, horizontal and vertical convergence, and color temperature

Automatic degauss at power on; manual degauss by turning power switch off, then on (capable of full degauss after monitor is turned off for 20 minutes or more)

I/O Ports

Two Apple Desktop Bus (ADB) ports and one ADB pass-through port





Physical and Electrical

Power Supply

Universal power supply

Voltage: 90–132 and 198–264 VAC, self-configuring

Frequency: 47–63 Hz

Power: 165 W maximum (less than 15 W in energy-saver mode)

Size and Weight

Height: 18.5 in. (474 mm)

Width: 18.5 in. (474 mm)

Depth: 19.6 in. (501.5 mm)

Monitor weight: 66 lb. (30 kg)

Fully boxed weight: 80 lb. (36 kg)





Monitor Stand

Built-in, tilt-and-swivel stand; tilt: -5 to $+15^{\circ}$; swivel range: $\pm 45^{\circ}$ minimum

Three ADB ports (two ADB ports are in the front of the stand and one ADB port is at the rear of the stand)





Environmental

Temperature

Operating: 50°F to 104°F (10°C to 40°C)

Storage: 32°F to 140°F (0°C to 60°C)

Shipping: -4°F to 140°F (-40°C to 60°C)

Altitude

Operating: to 10,000 ft. (1,067 m)

Shipping: to 35,000 ft. (3,048 m)

Humidity

Operating: 10-80% maximum, noncondensing

Storage: 5-90% maximum, noncondensing

Shipping: 5-95% maximum, noncondensing

Power Savings Feature

Conforms to the Energy Star Program of the United States
Environmental Protection Agency





Troubleshooting

Apple Multiple Scan 20 Display





General

The Symptom Charts included in this chapter will help you diagnose specific symptoms related to your product. Because cures are listed on the charts in the order of most likely solution, try the first cure first. Verify whether or not the product continues to exhibit the symptom. If the symptom persists, try the next cure. (Note: If you have replaced a module, reinstall the original module before you proceed to the next cure.)

If you are not sure what the problem is, or if the Symptom Charts do not resolve the problem, refer to the Flowchart for the product family.

For additional assistance, contact Apple Technical Support.





First Checklist

Important: Over 60% of the Apple Multiple Scan 20 Display modules returned for repair are found to be fully operational. Read this checklist before you return a module. Prevent needless module replacement and unnecessary time delays.



The Apple Multiple Scan 20 Display is not fully compatible with all Macintosh computers and PowerBooks.

If you suspect a loss of functionality, especially with the number of screen resolutions available (in Control Panels), check the Tech Info Library or contact Apple Technical Support.





- The CRT raster will not always resemble a perfect rectangle.**

CRT tolerances allow for some distortion. Additional distortion can be caused by magnetized metal objects (desks, file cabinets, etc.). Move the unit to a different location if you notice raster bowing or bent raster edges.

- Jitter, faint lines, or screen movement can be caused by external interference such as electronic devices and fluorescent lights.**

Move the unit to another room or building to help determine if external interference is the source of the problem.





- ✓ **A misadjusted screen can mimic the symptoms of deflection board or CRT failures.**

By performing the adjustment procedures, you might determine if one or more of the adjustments is the cause of the problem.

- ✓ **CRTs rarely fail.**

Needless CRT replacements can be prevented by checking display adjustments, checking the possibility of other defective modules, and accepting small imperfections in screen display.

If you have any doubts about whether a CRT is defective, contact Apple Technical Support.





Display Setting Restoration

Each Multiple Scan 20 Display has an EEPROM (located on the microprocessor controller board) that contains adjustment information specific to that monitor. Before you replace the microprocessor board, save this EEPROM information.

Use MacTest Pro Display Setting Restore Utility to preserve the monitor adjustment settings.

Connect the Hardware

There are two ways to connect the hardware to use the MacTest Pro Display Setting Restore Utility:

- 1 Connect a serial cable (MINI DIN-8) between the malfunctioning display and a separate computer running MacTest Pro. Use either the modem port or the printer port on the computer. (If you use the printer port, AppleTalk





must be turned off). Also connect a power cable to the display.

Advantage: You do not have to shut down the host computer or quit MacTest Pro to complete the repair.

Disadvantage: This method requires a separate host computer (with display).

- 2 Connect the display as usual, using a video cable and power cable. Also, connect a serial cable (MINI DIN-8) between the display and either the modem or printer port on the computer.

Advantage: This method lends itself to on-site repair; the display under repair is the only display required.

Disadvantage: Since the microprocessor board on the display needs to be replaced, the display may not be working well enough to view this utility in MacTest Pro.

Another disadvantage is that after creating the data file from





the old EEPROM, you must quit MacTest Pro and shut down the computer to install the new EEPROM.

Save the EEPROM Information

To save information from the old EEPROM, create a data file:

- 1 Start MacTest Pro.
- 2 Choose “Apple Multiple Scan 20 Display.”
- 3 Select “Test.”
- 4 Click “Create File.”

Install the Microprocessor Board

See Take Apart for instructions on installing the new microprocessor board.





After the new microprocessor board is installed, the new EEPROM will have default settings that allow you to read the display, but with difficulty. When the settings from the old EEPROM are transferred to the new EEPROM, the display should be clear and the last color temperature mode chosen restored.

Restore the EEPROM Information

To download the saved adjustment information to the new EEPROM,

- 1 Start MacTest Pro.
- 2 Choose “Apple Multiple Scan 20 Display.”
- 3 Select “Test.”
- 4 Click “Write File.”





Caution: Make certain that you are aware of the following important information about the EEPROM data file. If data is lost or corrupted, you will have to return the display to Apple for repair.

- Make sure that the data in the saved file is written back to the display used to create the file. Each display is unique, so writing the wrong data to a display may cause severe adjustment problems.
- Make sure that the data file is deleted after writing the data back to the display. This erasure ensures that data from one display is not accidentally written to another.
- Do not delete the new data file before it's written to the new EEPROM. If the file is lost before the data can be written to the new EEPROM, the repair will be impossible to complete and the whole display will need to be returned.





Symptom Charts

Raster

No raster; power indicator light on

- 1 Ensure monitor's video cable is properly connected to computer or video card in the computer.
- 2 Replace main deflection board.
- 3 Replace microprocessor board after downloading settings as described in "Display Setting Restoration" in this chapter.

Caution: To prevent data loss or corruption, always save EEPROM settings before you replace the microprocessor board.





Raster (Continued)

Raster jumps

Replace microprocessor board after downloading settings as described in “Display Setting Restoration” in this chapter.

Caution: To prevent data loss or corruption, always save EEPROM settings before you replace the microprocessor board.

Raster edges have color blotches when displaying an all-white screen

- 1 Degauss monitor with an external degaussing coil.
- 2 Move monitor to different location and repeat degaussing procedure.

Note: This symptom is caused by strong magnetic fields in the environment. Exchanging boards will not cure the symptom. Refer to “First Checklist” in this chapter.





Raster (Continued)

Raster distorted; no picture

- 1 Replace microprocessor board after downloading settings as described in “Display Setting Restoration” in this chapter.

Caution: To prevent data loss or corruption, always save EEPROM settings before you replace the microprocessor board.

- 2 Replace main deflection board.





Power

Monitor does not power up

- 1 Ensure monitor's video cable is properly connected to computer or video card in the computer, and check other cable connections.
- 2 Replace power supply.

Monitor shuts down

- 1 Ensure monitor's video cable is properly connected to computer or video card in the computer.
- 2 Replace main deflection board.
- 3 Replace CRT/video board.





Indicator Lights

Convergence
indicator light blinks
or stays on; power
indicator light might
also blink



Replace microprocessor board after downloading settings as described in “Display Setting Restoration” in this chapter.

Caution: To prevent data loss or corruption, always save EEPROM settings before you replace the microprocessor board.





Indicator Lights (Continued)

Rotation indicator
light blinks or stays
on; power indicator
light might also blink

Replace main deflection board.





Indicator Lights (Continued)

Size indicator light blinks or stays on; power indicator light might also blink

- 1 Replace main deflection board.
- 2 Replace CRT/video board.
- 3 Replace microprocessor board after downloading settings as described in “Display Setting Restoration” in this chapter.

Caution: To prevent data loss or corruption, always save EEPROM settings before you replace the microprocessor board.





Indicator Lights (Continued)

Centering indicator light blinks or stays on; power indicator light might also blink



- 1 Replace main deflection board.
- 2 Replace microprocessor board after downloading settings as described in “Display Setting Restoration” in this chapter.

Caution: To prevent data loss or corruption, always save EEPROM settings before you replace the microprocessor board.





Miscellaneous

Picture dim;
adjusting front panel
controls does not
increase brightness

- 1 Ensure that screen does not face a window or other source of ambient light. This type of environment gives screen a dim appearance.
- 2 Replace CRT/video board.

Picture has vertical
jitter

- 1 Move monitor to different location and see if symptom persists.

Note: This symptom is often caused by electromagnetic interference (electronic devices, fluorescent lights, power lines, etc.) Refer to “First Checklist” in this chapter.

- 2 Replace main deflection board.





Miscellaneous (Continued)

Monitor emits snapping sound; raster blinks for an instant

Note: This symptom, caused by foreign particles inside the CRT, normally occurs only in new monitors. If the symptom persists after 40 hours of operation, there is a hardware problem.

- 1 Replace power supply.
- 2 Check to see if arcing on main deflection board is cause. If so, replace main deflection board. If not, CRT is defective.

Picture color uneven

Adjust rotation and color uniformity. Refer to “Geometry” in the Adjustments chapter.

Focus blurry on one side of screen

- 1 Adjust focus. Refer to “Convergence” in the Adjustments chapter.
- 2 Replace main deflection board.





Miscellaneous (Continued)

Upon first use, monitor screen shows cloth-like pattern of black, dark gray, or white fine vertical lines

- 1 Select the all white display pattern, and adjust size and rotation controls on the monitor's front panel. Aim for reducing the visibility of the lines while minimizing discoloration.
- 2 At power-on, lightly tap the side of the monitor so you see the display image move. After the display has warmed up for 30 minutes, tap the monitor again.
- 3 Call Service Provider Support at 1-800-919-2775 (Option 6) to replace the display.





Take Apart

Apple Multiple Scan 20 Display



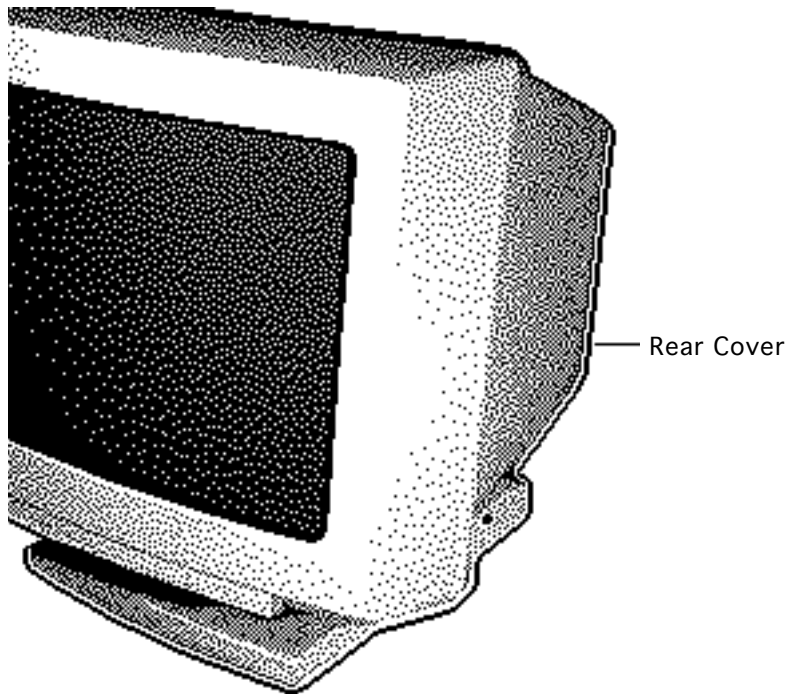

Rear Cover

No preliminary steps are required before you begin this procedure.

⚠ Warning: This product contains high voltage and a high-vacuum picture tube. To prevent serious injury, review CRT safety in Bulletins/Safety.



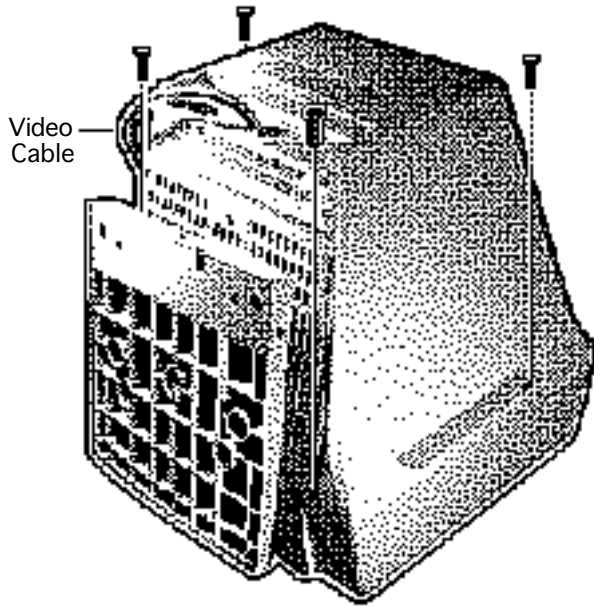

- 1 With the monitor face-down on a protective pad, remove the four case screws and pull the rear cover off the chassis.
- 2 Route the video cable through the cover.



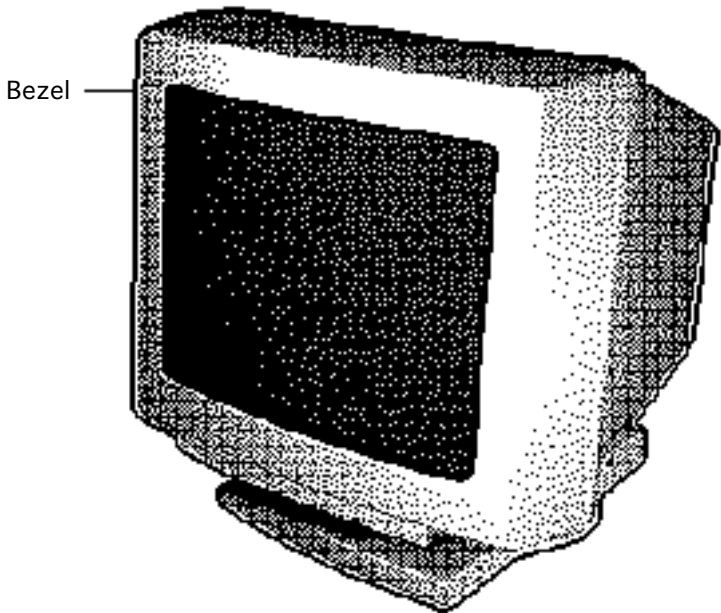

Bezel

Before you begin, remove the following:

- Rear cover
- EMI shield

⚠ Warning: This product contains high voltage and a high-vacuum picture tube. To prevent serious injury, review CRT safety in Bulletins/Safety.





- 1 Remove the grounding screw.

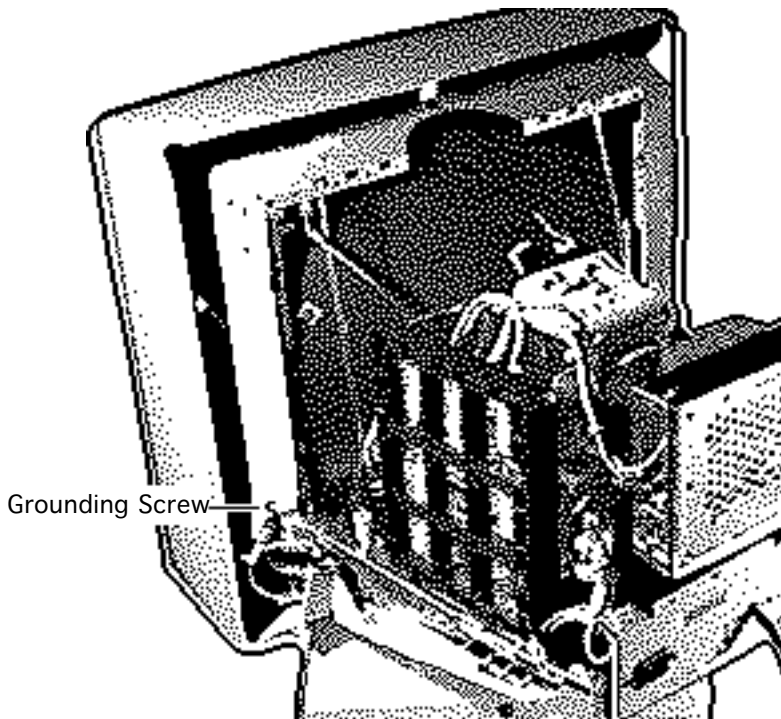

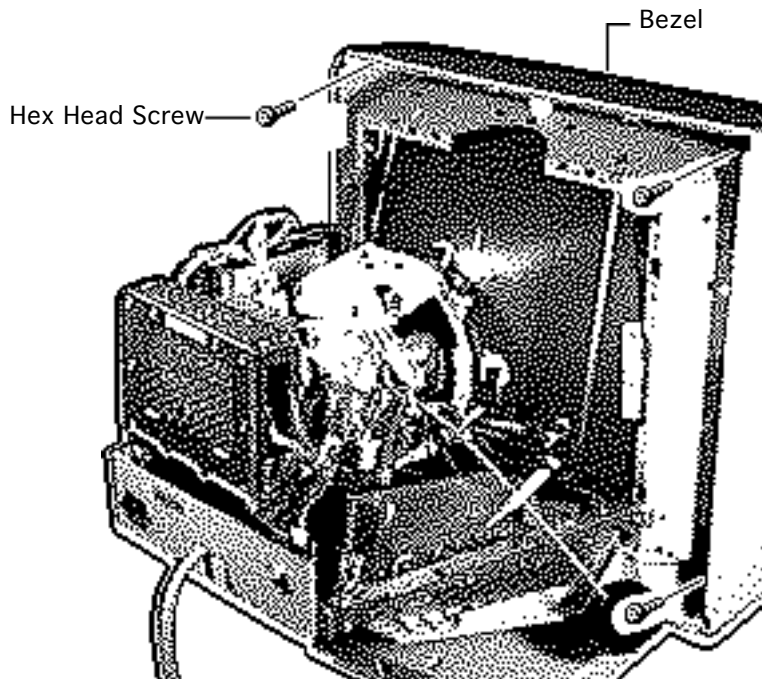

- 2 Remove the four large hex head screws and remove the bezel.



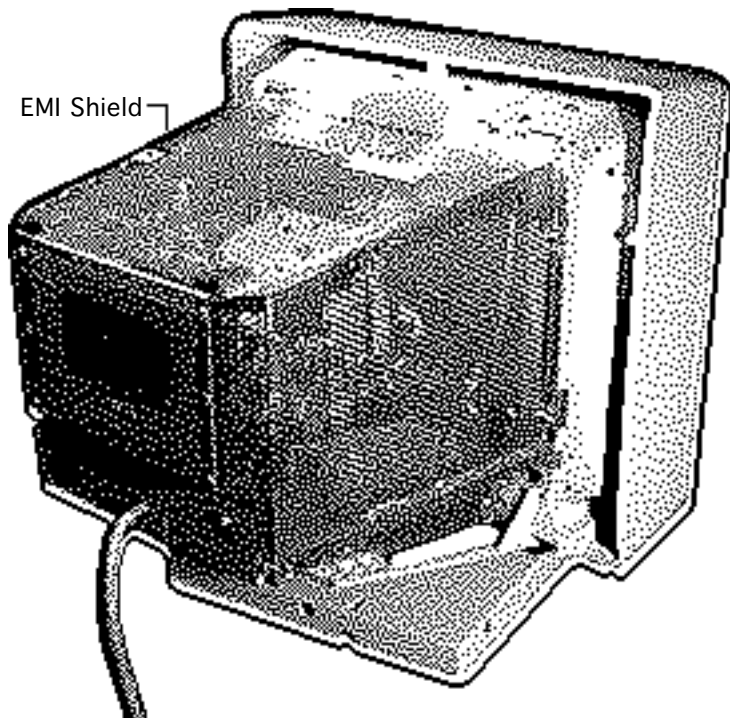

EMI Shield

Before you begin,

- Remove the rear cover
- Discharge the CRT

⚠ Warning: This product contains high voltage and a high-vacuum picture tube. To prevent serious injury, review CRT safety in Bulletins/Safety.

⚠ Warning: Never use a grounding wriststrap until after discharging the CRT.

Note: The EMI shield is not replaceable.



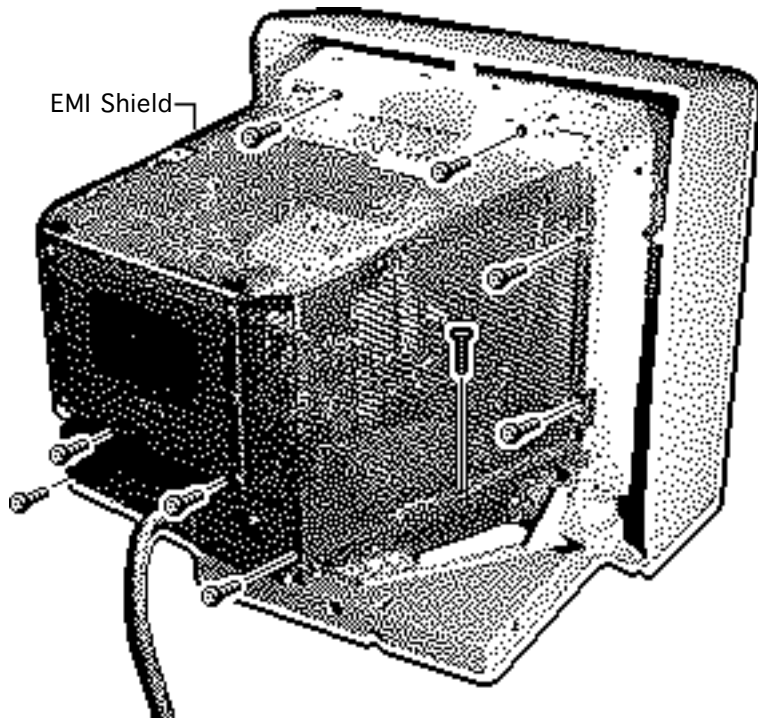

- 1 Remove the 12 screws from the shield. (Three screws are located on the left side of the EMI shield.)





EMI Shield

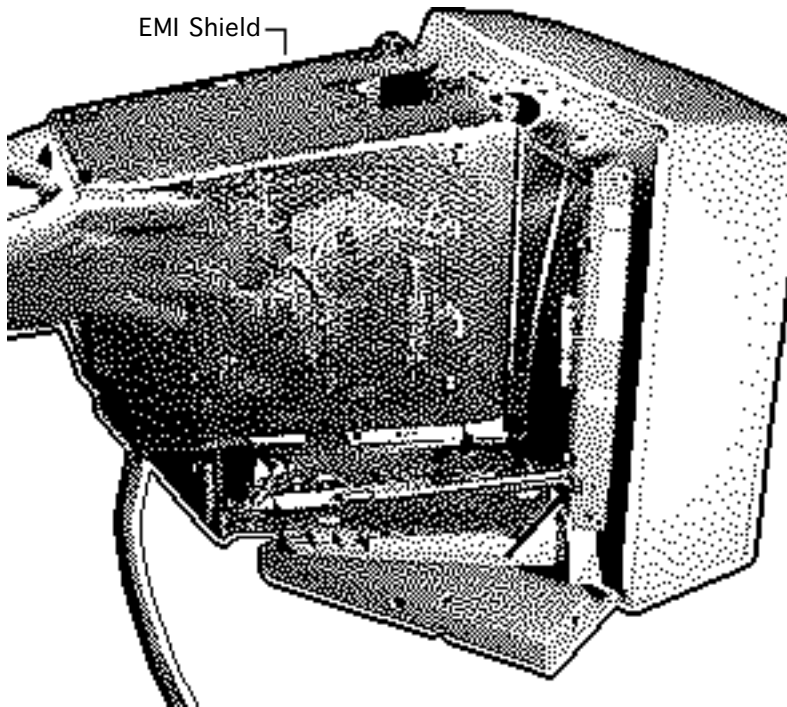

- 2 Slide the shield toward the back of the monitor and lift off the shield.



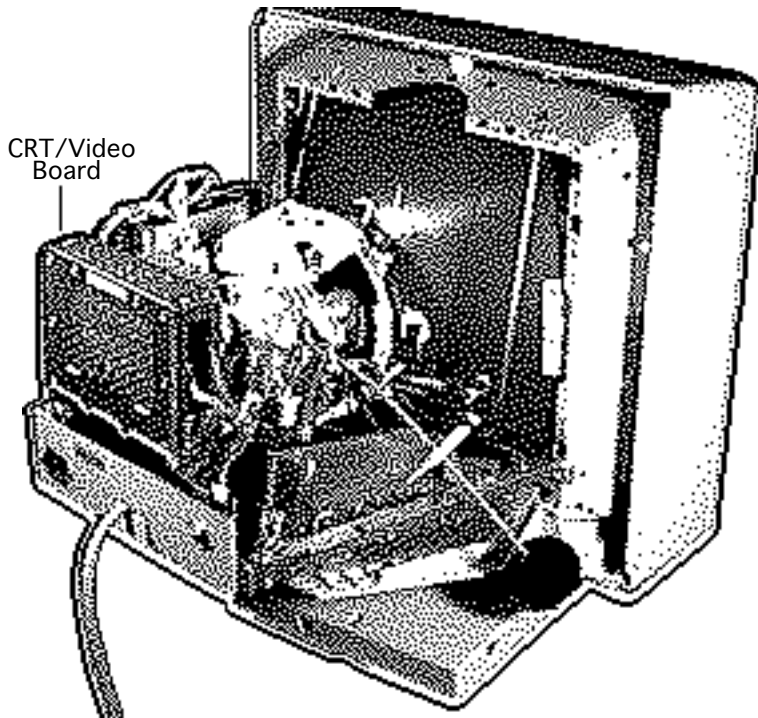

CRT/Video Board

Before you begin,

- Remove the rear cover
- Discharge the CRT
- Remove the EMI shield

⚠ Warning: This product contains high voltage and a high-vacuum picture tube. To prevent serious injury, review CRT safety in Bulletins/Safety.



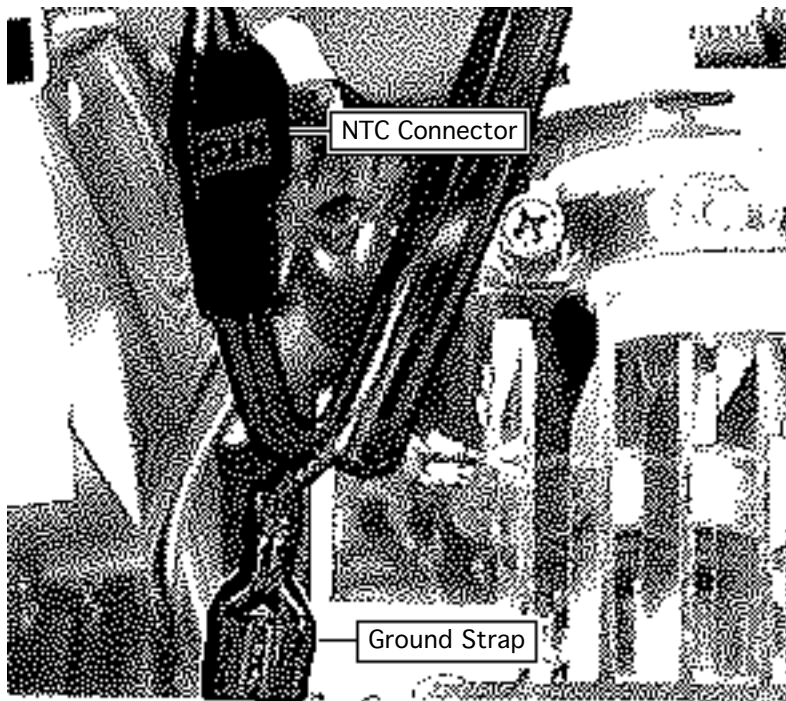

⚠ Warning: Never use a grounding wriststrap until after discharging the CRT.

- 1 **Caution:** When removing the ground strap from the CRT/video board, be careful not to apply excessive pressure to the neck of the CRT.

Disconnect the ground strap from the terminal on the front of the CRT/video board shield.

- 2 Disconnect the NTC connector.



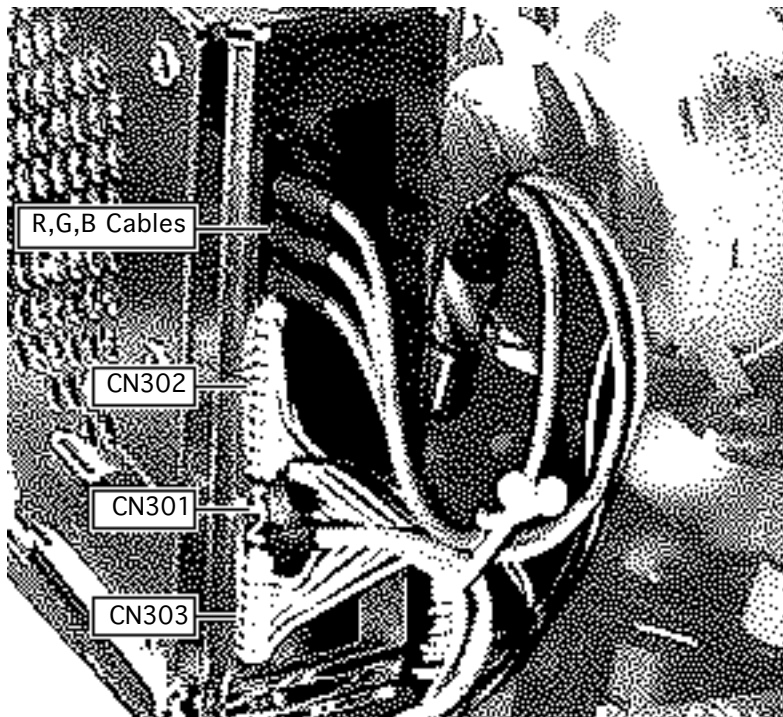

Caution: When disconnecting the following cables from the CRT/video board, be careful not to apply excessive pressure to the neck of the CRT.

3 Disconnect these cables from the CRT/video board:

- 11-wire cable (CN302)
- 7-wire cable (CN303)
- 3-wire cable (CN301)
- R, G, and B video cables



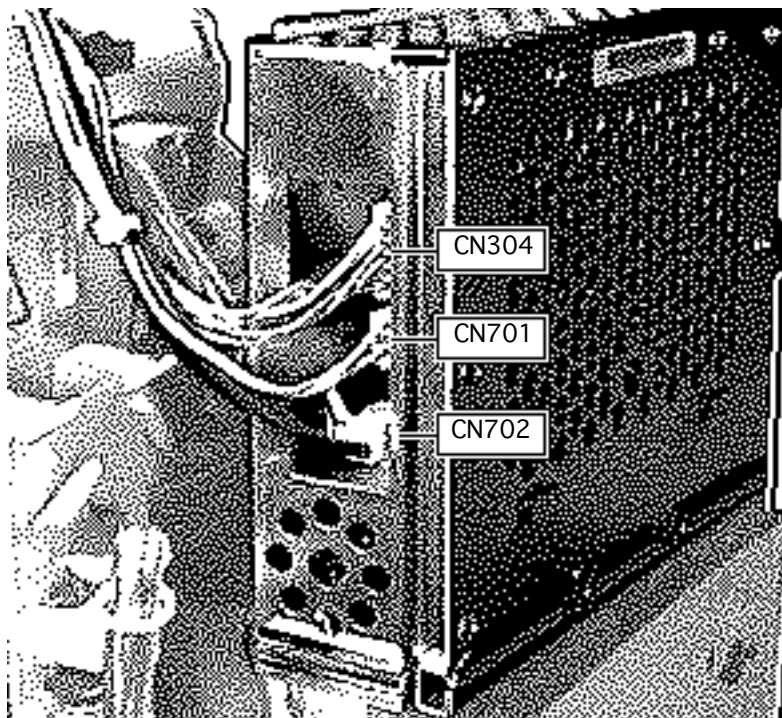

Caution: When disconnecting the following cables from the CRT/video board, be careful not to apply excessive pressure to the neck of the CRT.

4 Disconnect these cables from the CRT/video board:

- 1-wire cable (CN702)
- 6-wire cable (CN304)
- 3-wire cable (CN701)



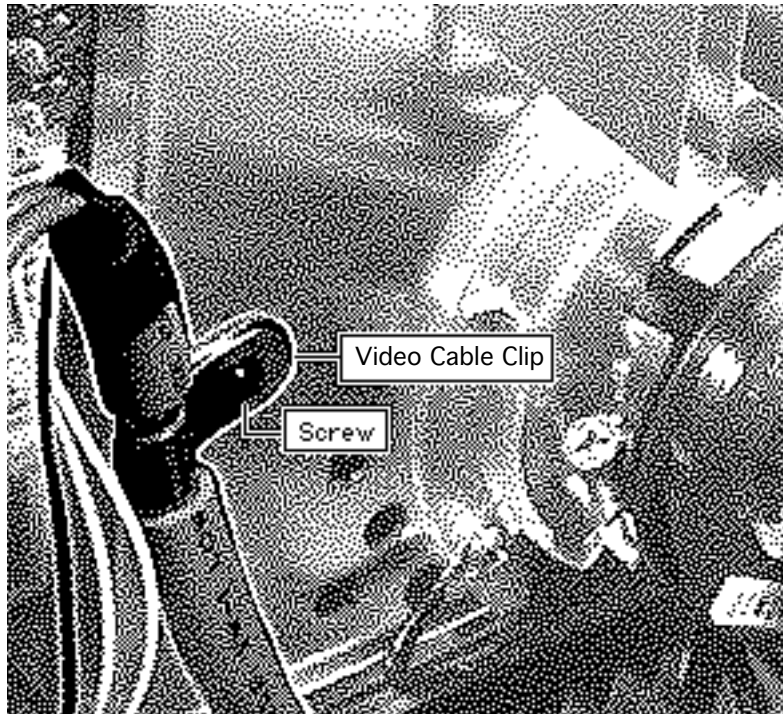

Caution: When removing the video cable from the CRT/video board, be careful not to apply excessive pressure to the neck of the CRT.

- 5 Remove the screw securing the video cable clip to the CRT/video board shield.



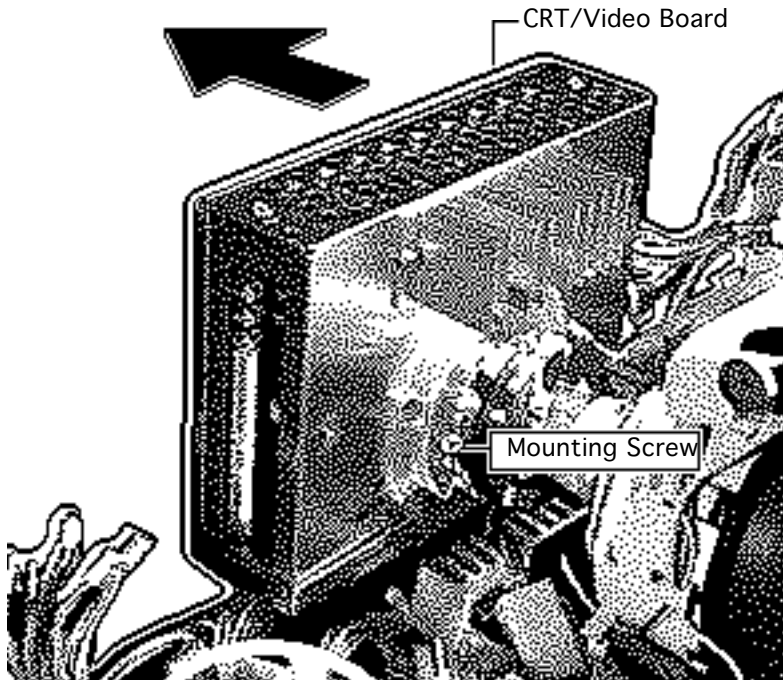

Caution: Twisting, bending, or applying force to the CRT/video board could damage the neck of the CRT. Be sure to pull the CRT/video board straight off the CRT.

- 6 Loosen the mounting screw and pull the CRT/video board straight off the neck of the CRT.



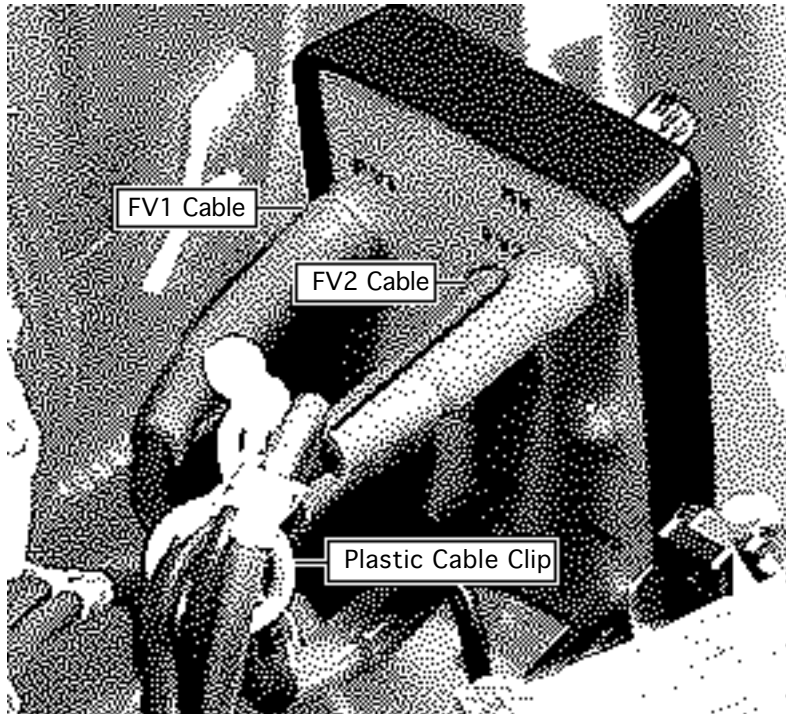

- 7 Remove the two plastic cable clips on the focus VR control cables.
- 8 Disconnect the FV1 and FV2 cables from the focus control board.





Power Supply

Before you begin,

- Remove the rear cover
- Discharge the CRT
- Remove the EMI shield

⚠ Warning: This product contains high voltage and a high-vacuum picture tube. To prevent serious injury, review CRT safety in Bulletins/Safety.

⚠ Warning: Never use a grounding wriststrap until after discharging the CRT.

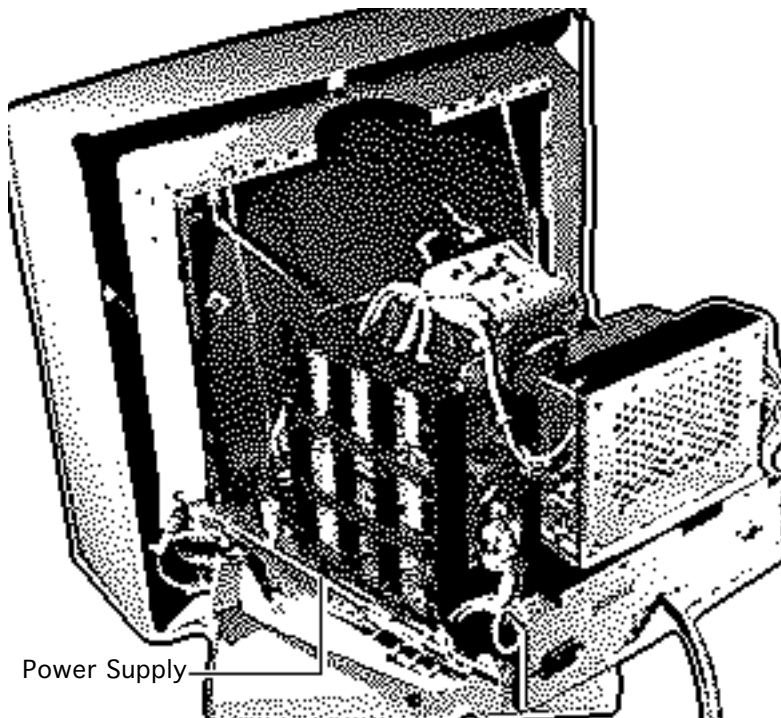

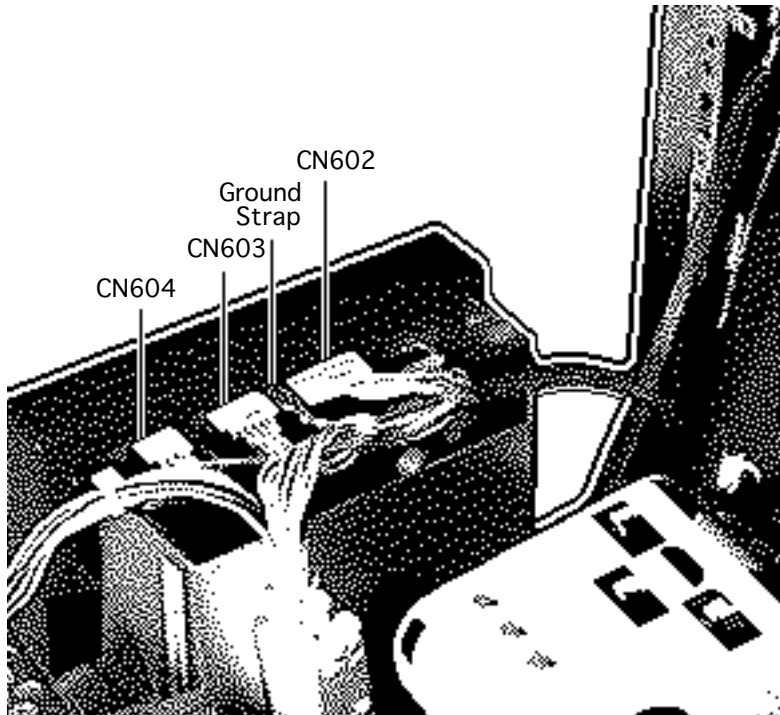

- 1 Disconnect these cables from the power supply:
 - 8-wire cable (CN602)
 - 5-wire cable (CN603)
 - 2-wire cable (CN604)
 - Ground strap
- 2 Remove the wiring harness from the plastic cable clip.



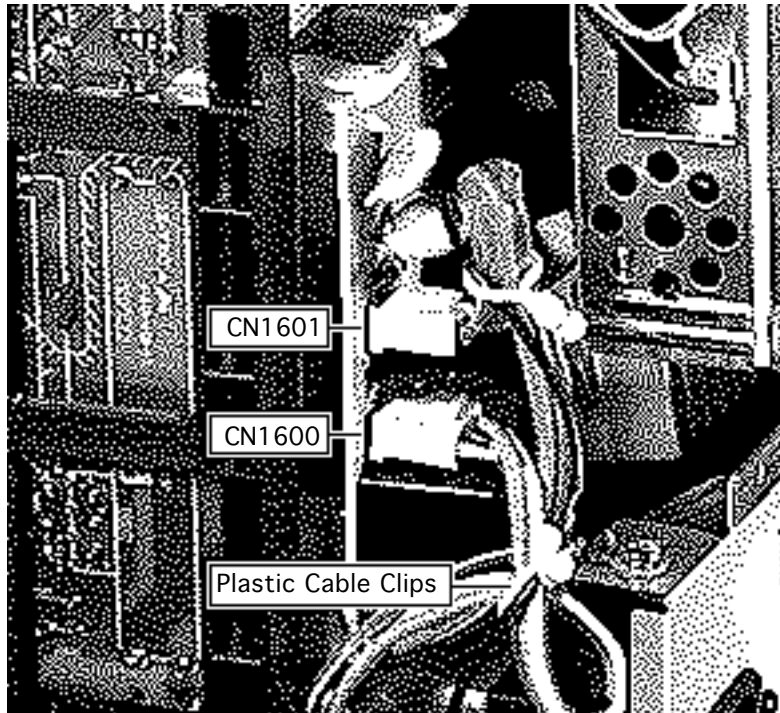

- 3 Disconnect these cables from the AC interconnect board:
 - CN1600
 - CN1601
- 4 Remove plastic cable clips.



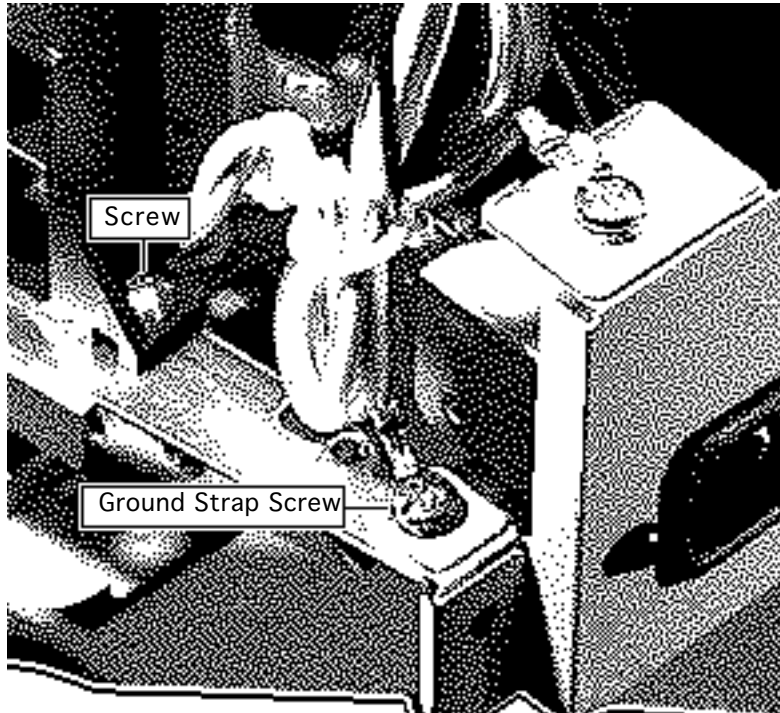

- 5 Remove the screw securing the ground strap to the chassis.
- 6 Remove the screw securing the power supply to the chassis.
- 7 Slide the power supply toward the rear of the monitor and lift out the power supply.



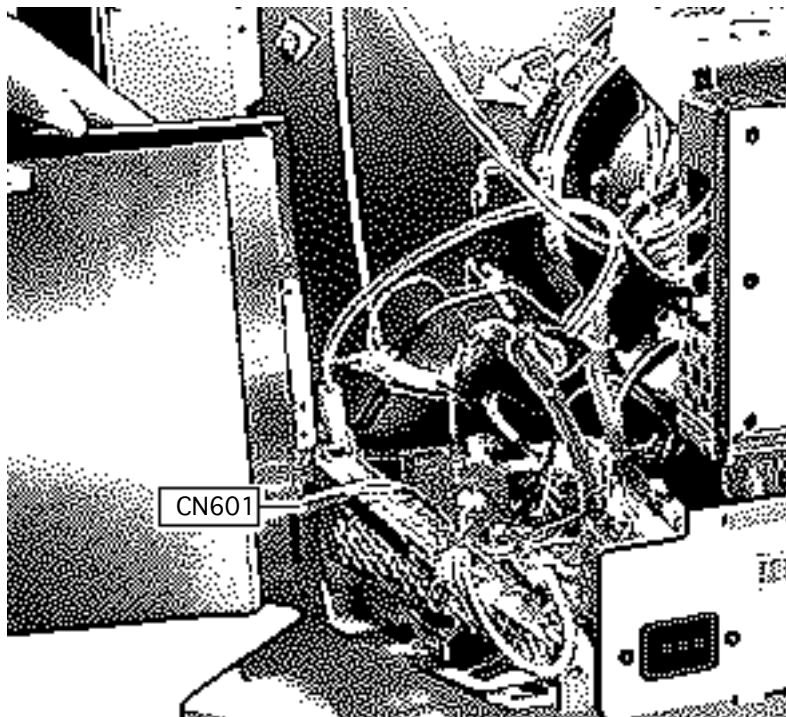

- 8 Disconnect connector CN601.



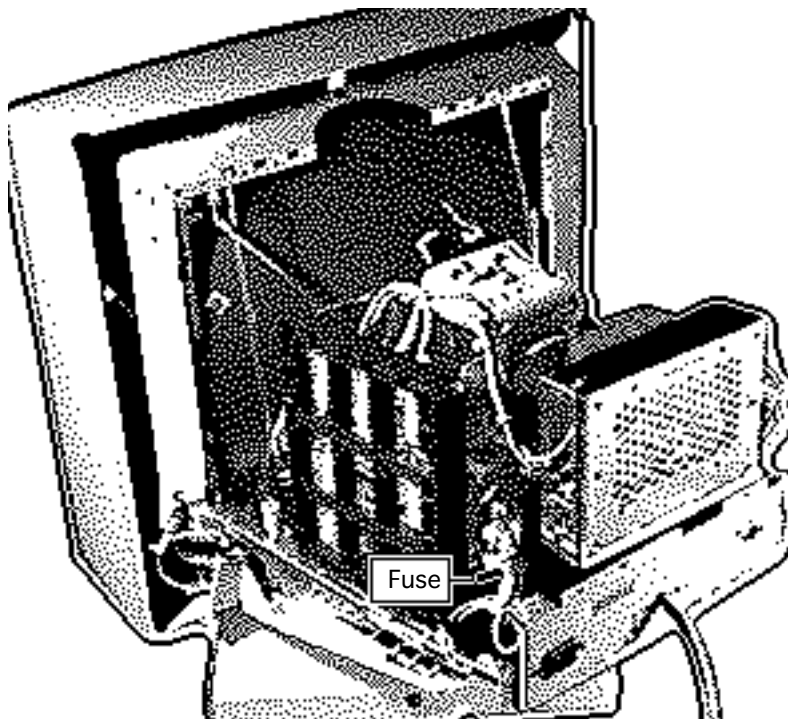

Fuse

Before you begin,

- Remove the rear cover
- Discharge the CRT
- Remove the EMI shield
- Remove the power supply

⚠ Warning: This product contains high voltage and a high-vacuum picture tube. To prevent serious injury, review CRT safety in Bulletins/Safety.



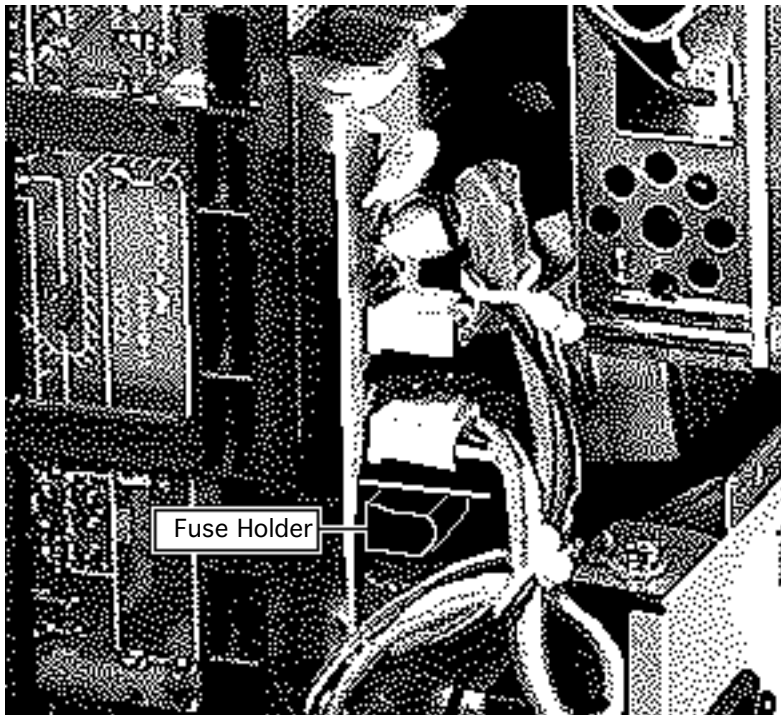

⚠ Warning: Never use a grounding wriststrap until after discharging the CRT.

- 1 Remove the plastic cover from the fuse holder.
- 2 Pry the fuse from the fuse holder using a jeweler's screwdriver.

Replacement Note: Be sure to replace the fuse with another fuse of the same amperage and voltage rating.





Focus VR Control

Before you begin,

- Remove the rear cover
- Discharge the CRT
- Remove the EMI shield

⚠ Warning: This product contains high voltage and a high-vacuum picture tube. To prevent serious injury, review CRT safety in Bulletins/Safety.

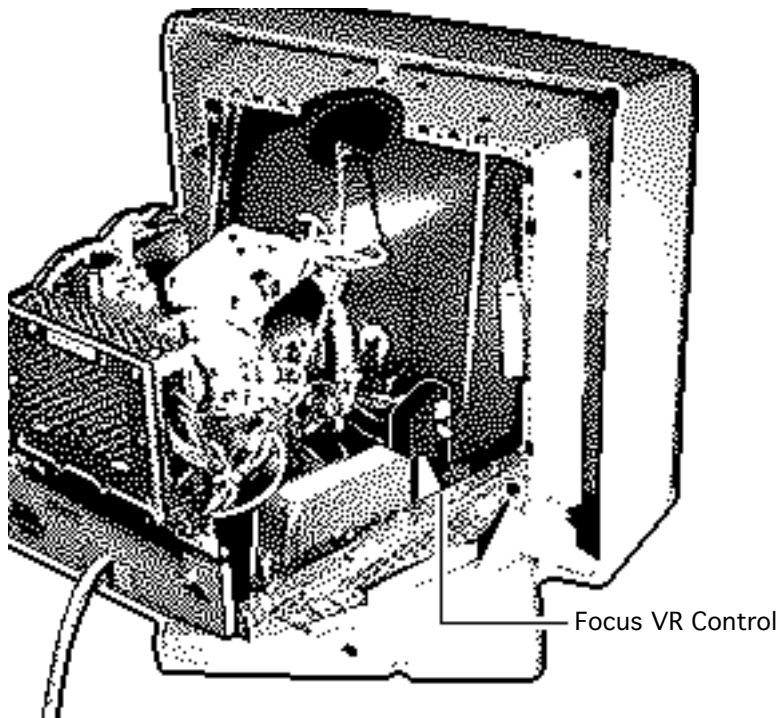

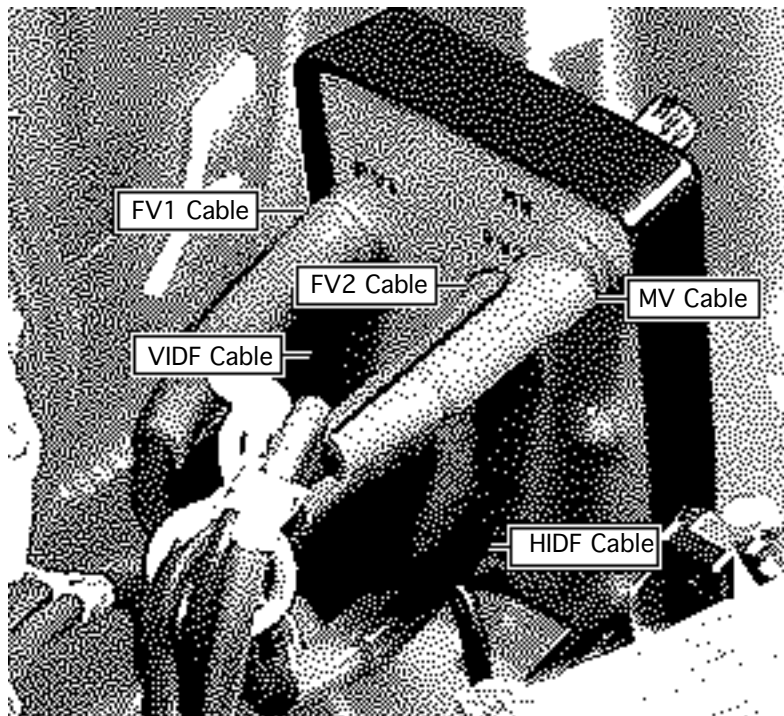

⚠ Warning: Never use a grounding wriststrap until after discharging the CRT.

- 1 Disconnect these cables from the focus control:
 - MV
 - FV1
 - FV2
 - VIDF
 - HIDF



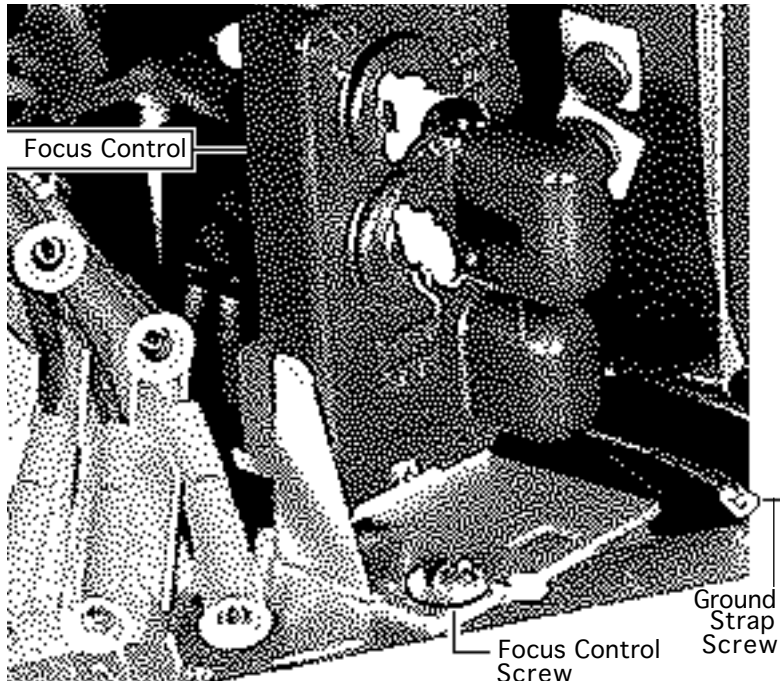

- 2 Remove the screw securing the ground strap to the chassis.
- 3 Remove the screw securing the focus control to the chassis.
- 4 Lift out the focus control.





AC Inlet Assembly

Before you begin,

- Remove the rear cover
- Discharge the CRT
- Remove the EMI shield
- Remove the power supply

⚠ Warning: This product contains high voltage and a high-vacuum picture tube. To prevent serious injury, review CRT safety in Bulletins/Safety.

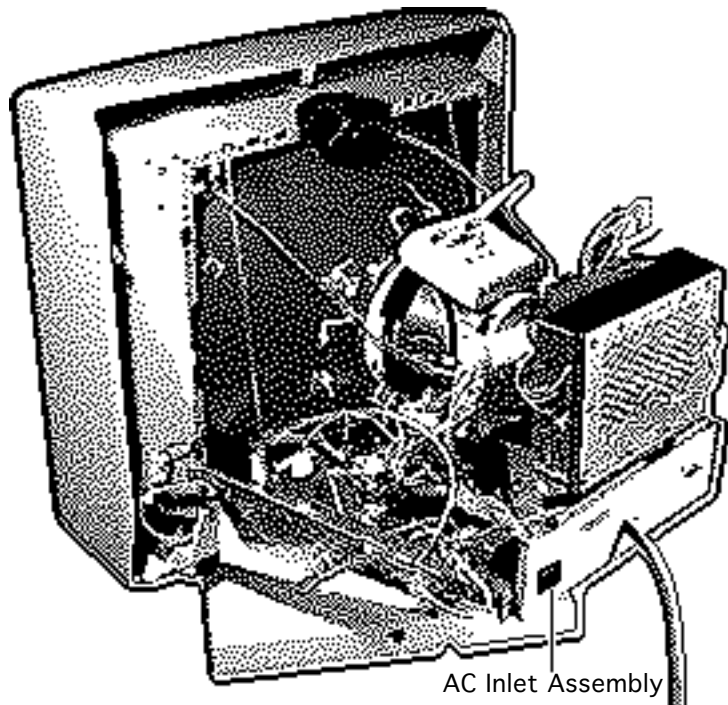

AC Inlet Assembly



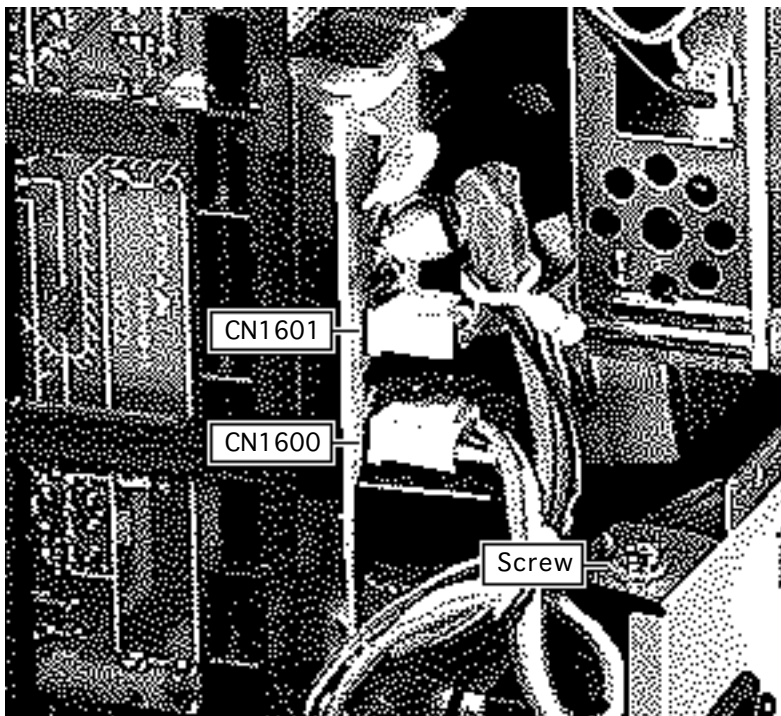

⚠ Warning: Never use a grounding wriststrap until after discharging the CRT.

- 1 Disconnect these cables from the AC interconnect board:
 - CN1600
 - CN1601
- 2 Remove the screw securing the AC inlet ground strap to the chassis.



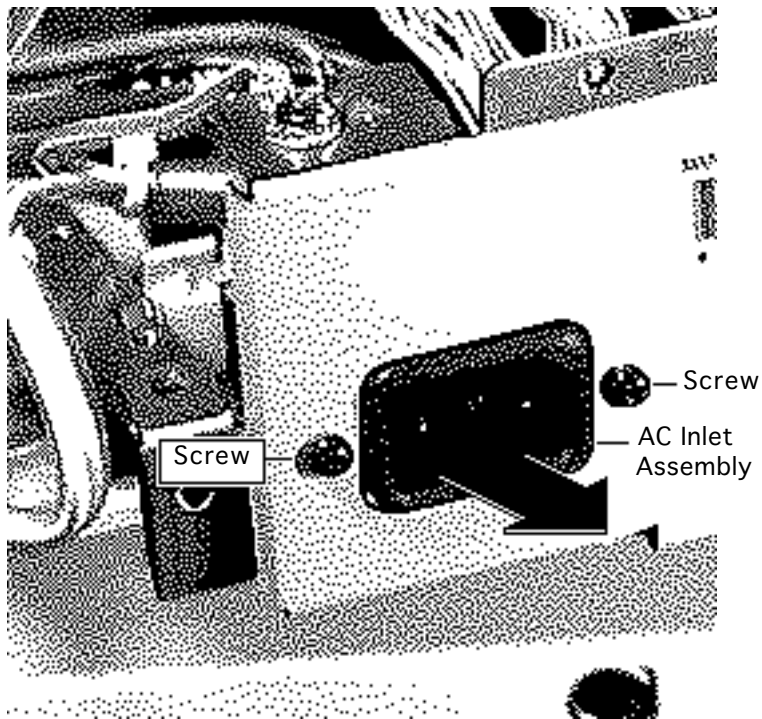

- 3 Remove the two screws securing the AC inlet assembly to the chassis.
- 4 Lift out the AC inlet assembly.



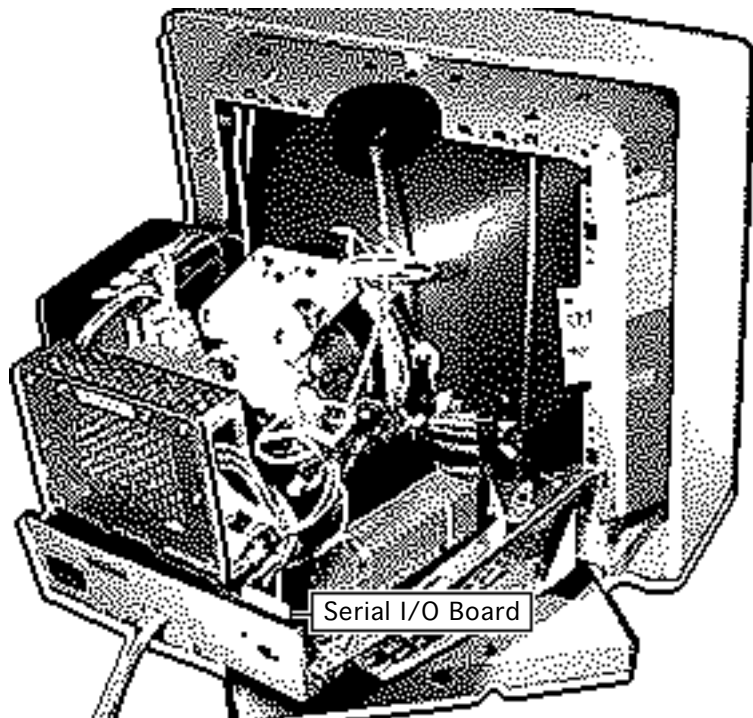

Serial I/O Board

Before you begin,

- Remove the rear cover
- Discharge the CRT
- Remove the EMI shield

⚠ Warning: This product contains high voltage and a high-vacuum picture tube. To prevent serious injury, review CRT safety in Bulletins/Safety.

⚠ Warning: Never use a grounding wriststrap until after discharging the CRT.



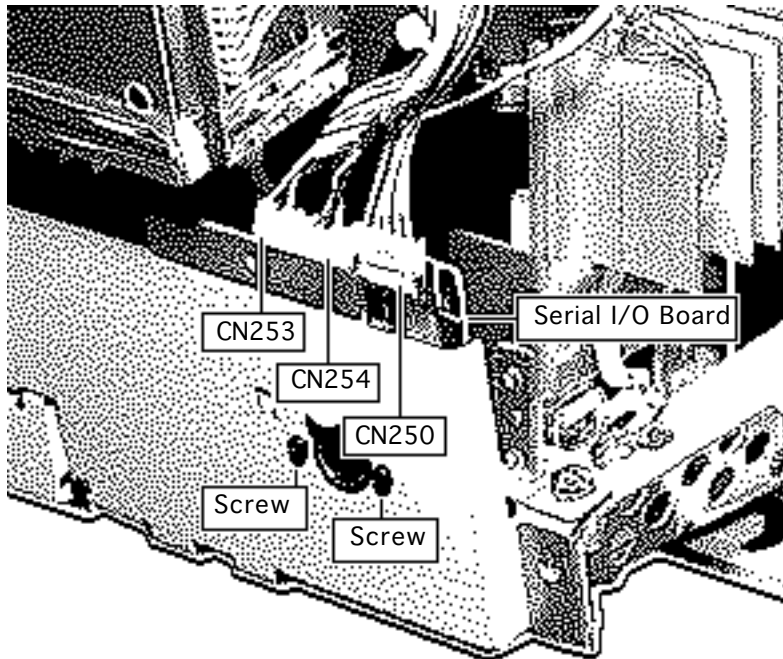

- 1 Disconnect these cables from the serial I/O board:
 - CN250
 - CN253 (from video cable)
 - CN254 (from CRT/video board)
- 2 Remove the two screws securing the serial I/O board to the rear panel.
- 3 Lift out the serial I/O board.





Replacement Note: The 3-pin connector from the video cable connects to connector CN253 and the 3-pin connector from the CRT/video board connects to connector CN254.



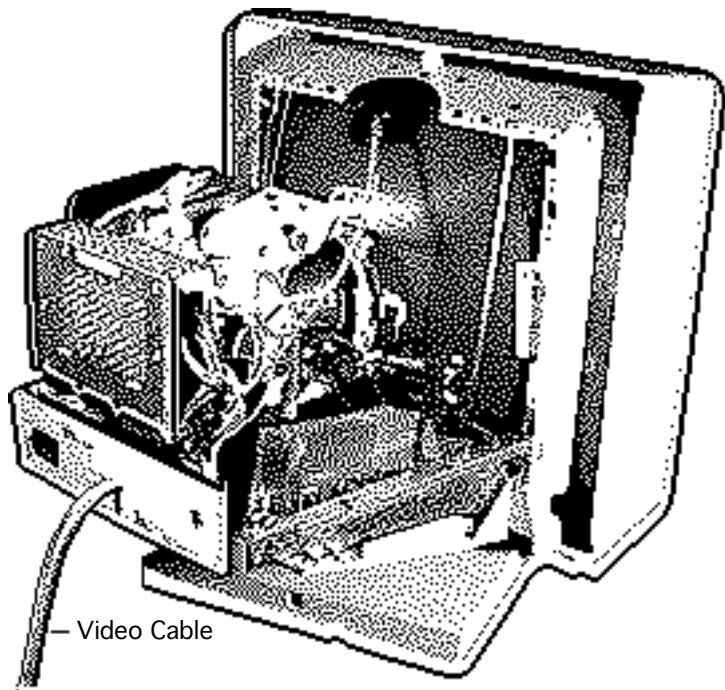

Video Cable

Before you begin,

- Remove the rear cover
- Discharge the CRT
- Remove the EMI shield

⚠ Warning: This product contains high voltage and a high-vacuum picture tube. To prevent serious injury, review CRT safety in Bulletins/Safety.

⚠ Warning: Never use a grounding wriststrap until after discharging the CRT.



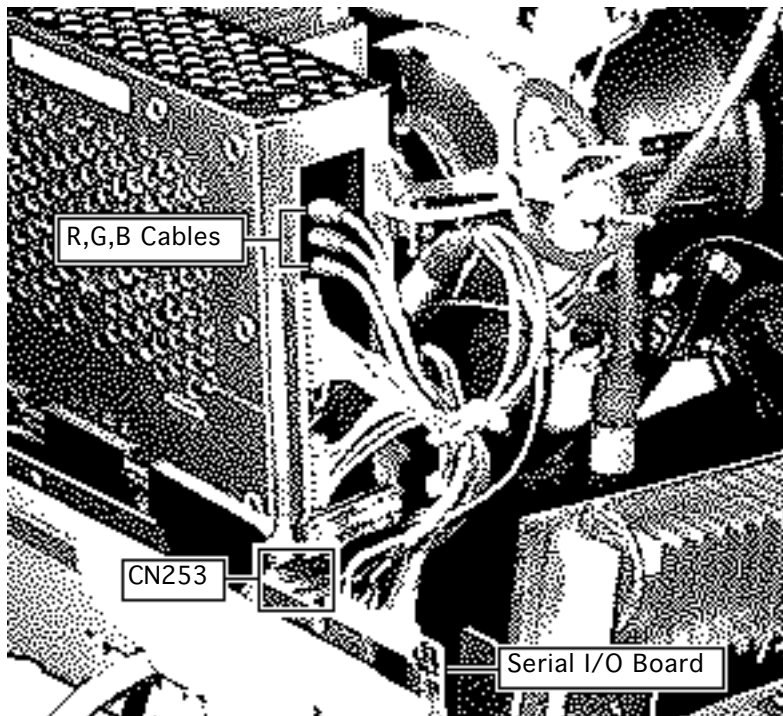

- 1 Disconnect connector CN253 from the serial I/O board.
- 2 Disconnect the R, G, and B cables from the CRT/ video board.



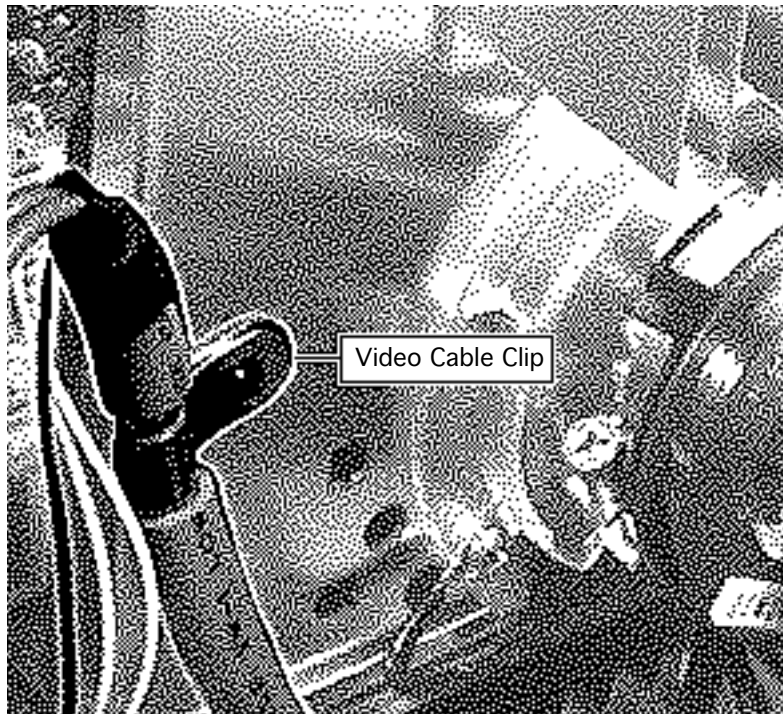

- 3 **Caution:** When removing the video cable from the CRT/video board, be careful not to apply excessive pressure to the neck of the CRT.

Remove the screw securing the video cable clip to the CRT/video board shield.

- 4 Remove the plastic cable clip.



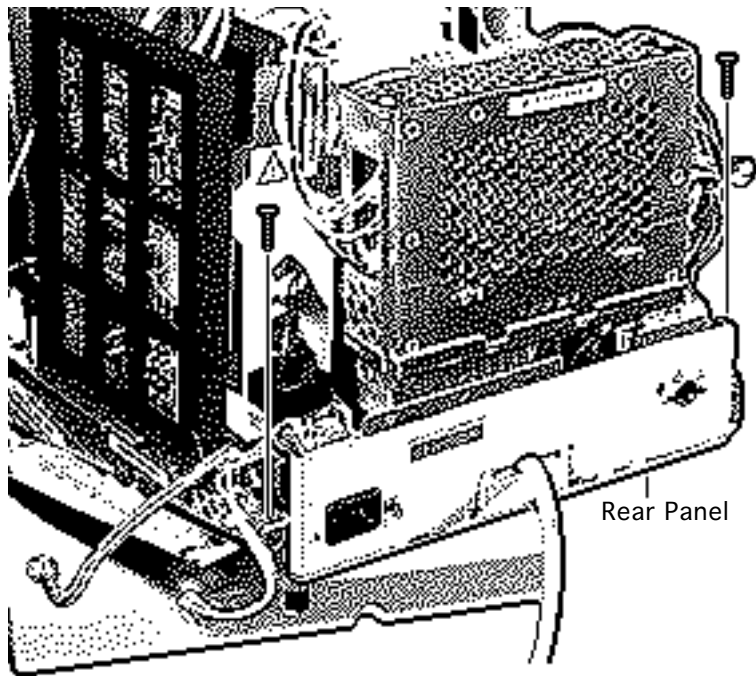

- 5 Remove the two screws securing the rear panel to the chassis.
- 6 Rotate the rear panel away from the chassis.
- 7 Remove the rear panel from the chassis.



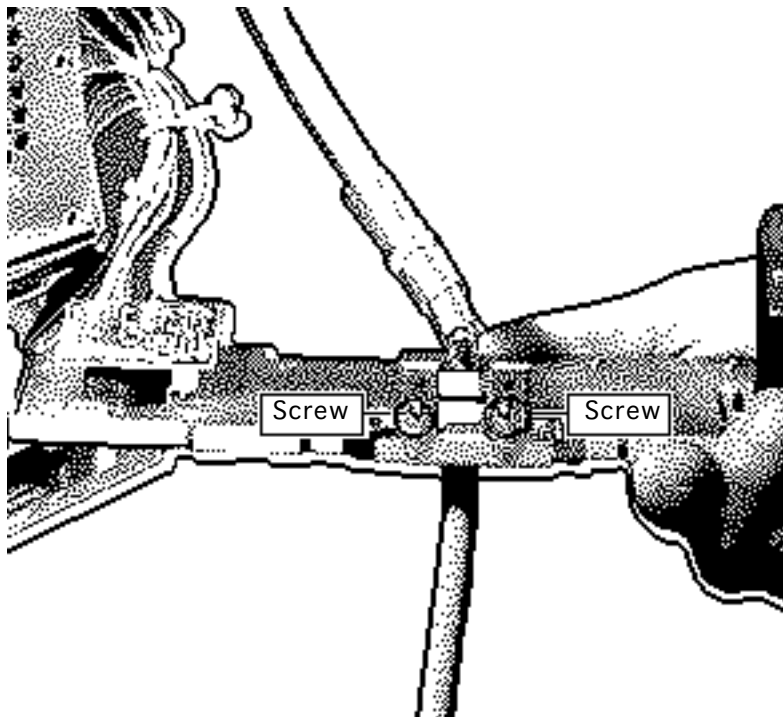

- 8 Remove the two screws securing the cable clamp to the rear panel.
- 9 Remove the video cable.





Main Deflection Board

Before you begin,

- Remove the rear cover
- Discharge the CRT
- Remove the EMI shield
- Remove the power supply

⚠ Warning: This product contains high voltage and a high-vacuum picture tube. To prevent serious injury, review CRT safety in Bulletins/Safety.

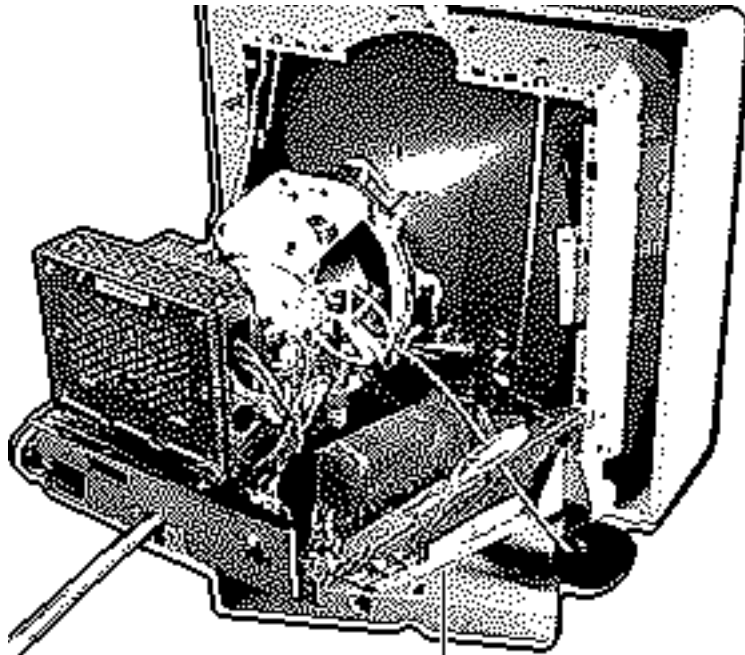

Main Deflection Board



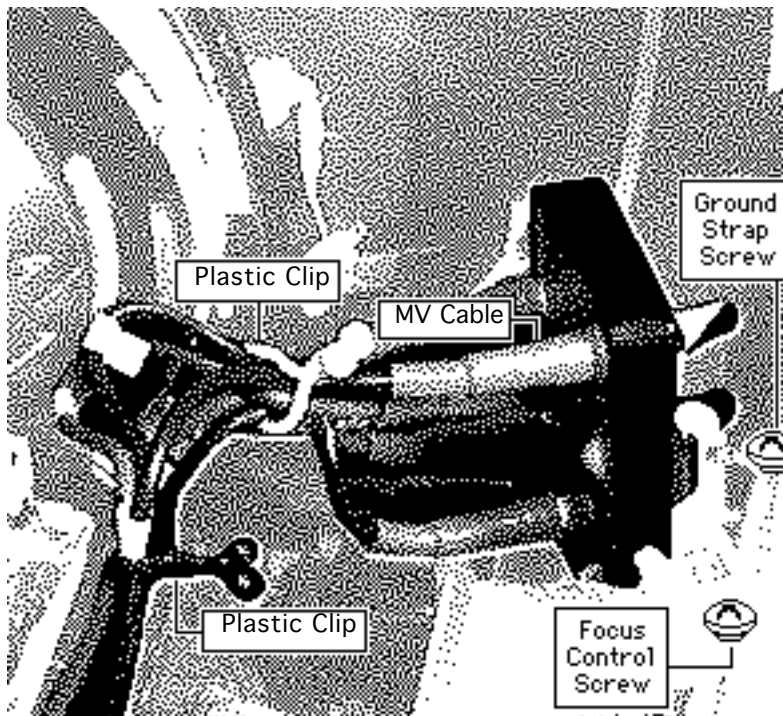

- 1 Disconnect the MV cable from the focus VR control.
- 2 Remove the two plastic cable clips on the focus VR control cables.
- 3 Remove the screw securing the ground strap to the chassis.
- 4 Remove the screw securing the focus control to the chassis.
- 5 Lift out the focus control and let it hang outside the chassis.



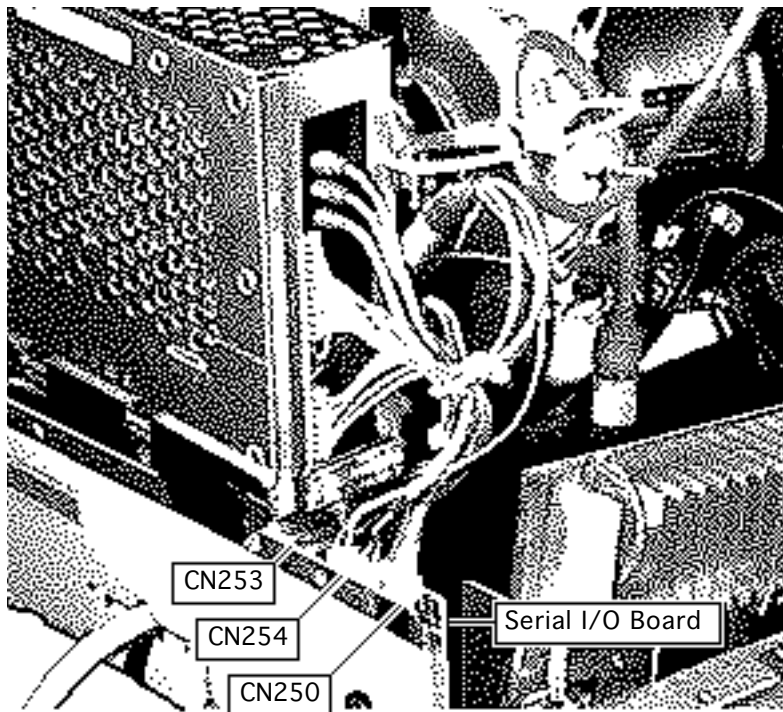

- 6 Disconnect these cables from the serial I/O board:
- CN250
 - CN253 (from video cable)
 - CN254 (from CRT/video board)

Replacement Note: The 3-pin connector from the video cable connects to connector CN253 and the 3-pin connector from the CRT/video board connects to connector CN254.



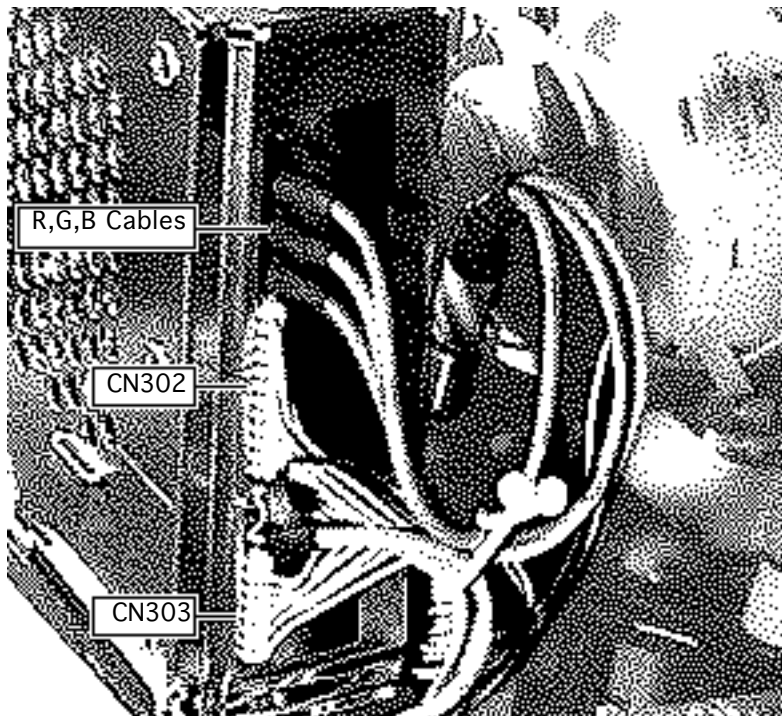

- 7 **Caution:** When disconnecting the following cables from the CRT/video board, be careful not to apply excessive pressure to the neck of the CRT.

Disconnect these cables from the CRT/video board:

- 11-wire cable (CN302)
- 7-wire cable (CN303)
- R, G, and B video cables



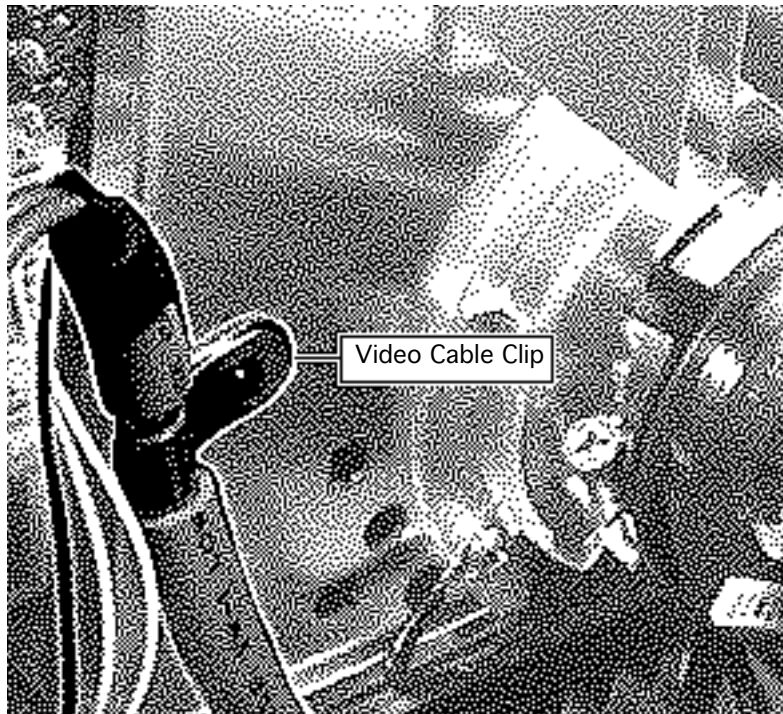

- 8 **Caution:** When removing the video cable from the CRT/video board, be careful not to apply excessive pressure to the neck of the CRT.

Remove the screw securing the video cable clip to the CRT/video board shield.



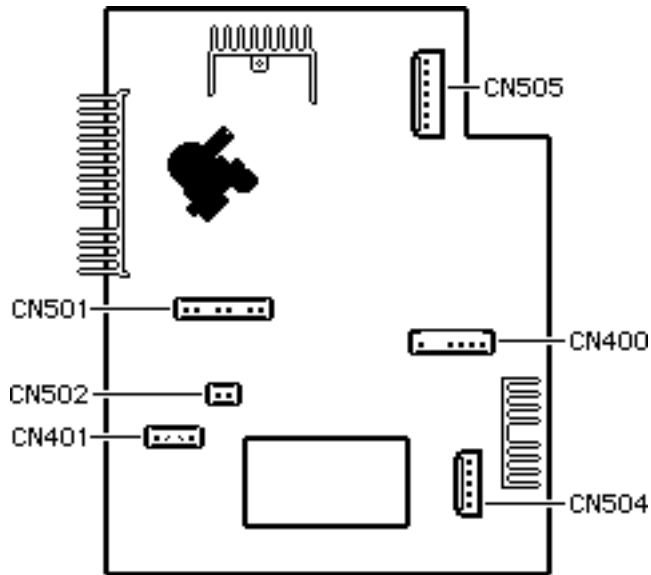

9 Disconnect these cables from the main deflection board:

- 2-wire cable (CN401)
- 2-wire cable (CN502)
- 2-wire cable (CN1604)
- 6-wire cable (CN505)
- 5-wire cable (CN504)
- 5-wire cable (CN400)





- 6-wire cable (CN501)
- gold-colored connector (CN502)
- 6-pin connector (control panel) (CN401)

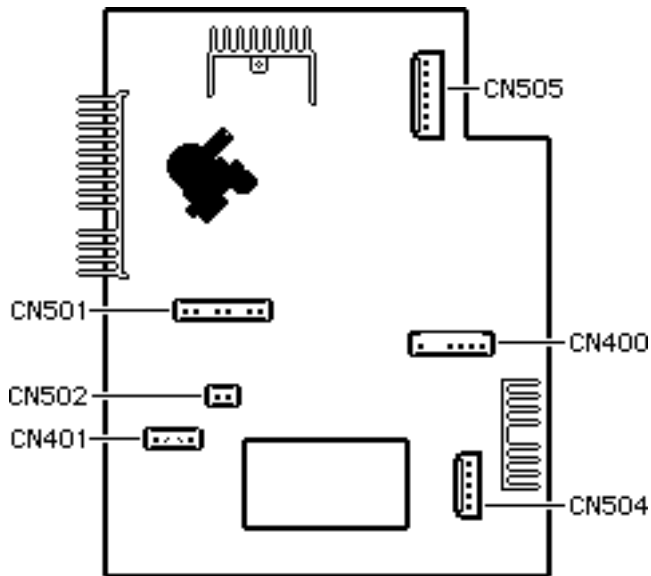

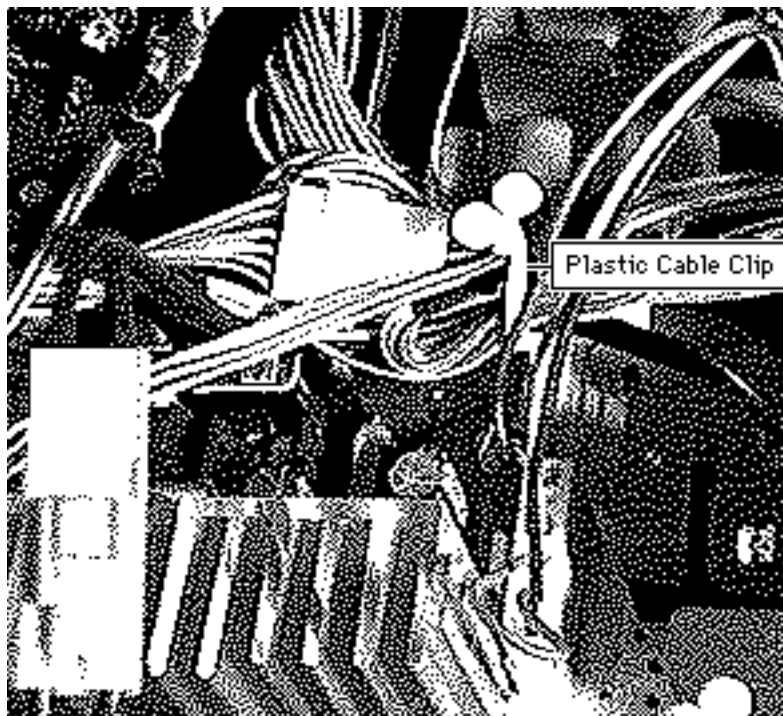

- 10 Remove the cables from the plastic cable clip.



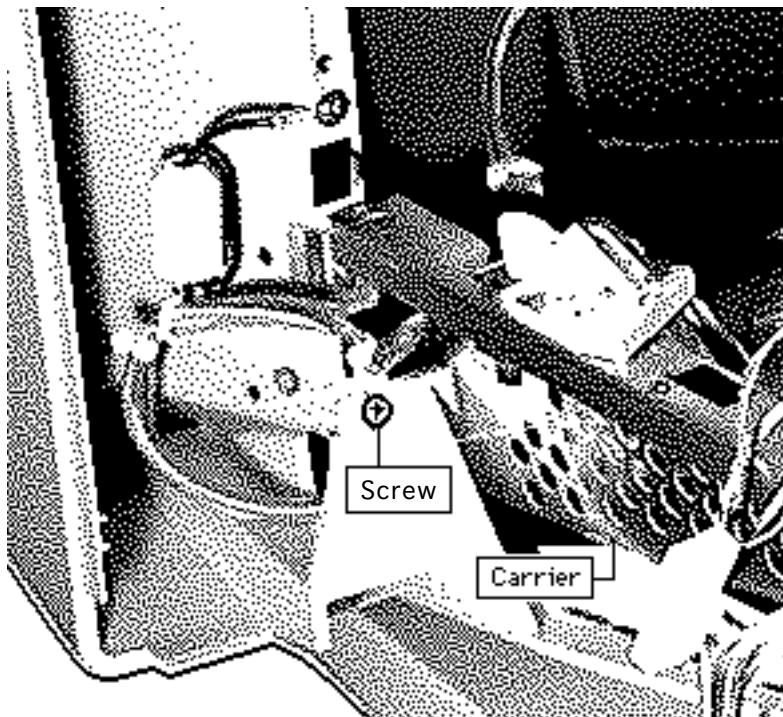

- 11 Remove the two screws securing the main deflection board carrier to the chassis. (Only one screw is shown in the illustration. The other screw is on the opposite side of the carrier.)
- 12 Slide back the carrier.
- 13 Remove the main deflection board.





Microprocessor Board

Before you begin,

- Save EEPROM settings
- Remove the rear cover
- Discharge the CRT
- Remove the EMI shield
- Remove the power supply
- Remove the main deflection board

Important: Before you replace the microprocessor board, save the EEPROM settings. See Troubleshooting for instructions.

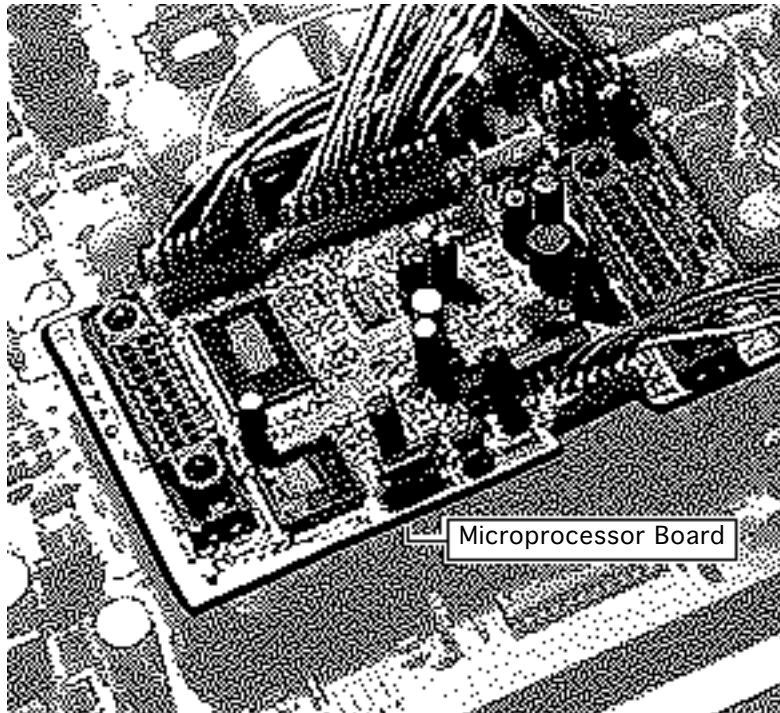



⚠ Warning: This product contains high voltage and a high-vacuum picture tube. To prevent serious injury, review CRT safety in Bulletins/Safety.

⚠ Warning: Never use a grounding wriststrap until after discharging the CRT.



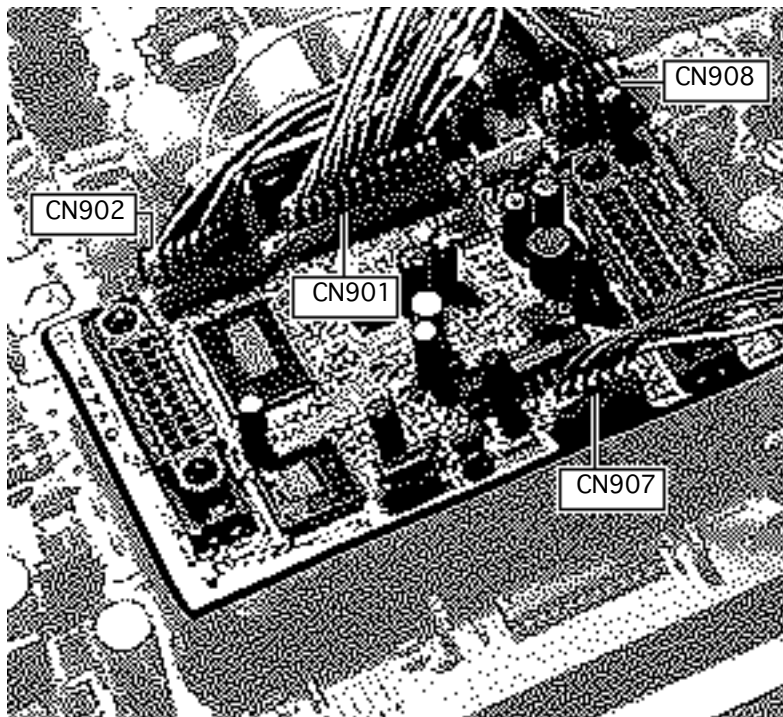

Important: Make sure you save the EEPROM settings before replacing the microprocessor board.

- 1 Disconnect these cables from the microprocessor board:
 - 11-wire cable (CN901)
 - 7-wire cable (CN902)
 - 6-wire cable (CN907)
 - 5-wire cable (CN908)
- 2 Remove the microprocessor board.



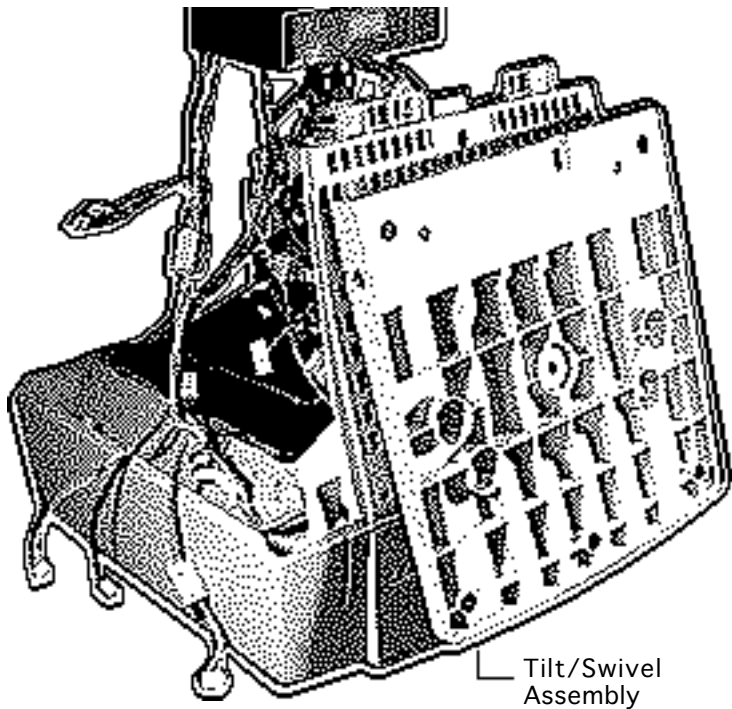

Tilt/Swivel Assembly

Before you begin,

- Remove the rear cover
- Discharge the CRT
- Remove the EMI shield
- Remove the power supply
- Remove the main deflection board

⚠ Warning: This product contains high voltage and a high-vacuum picture tube. To prevent serious injury, review CRT safety in Bulletins/Safety.



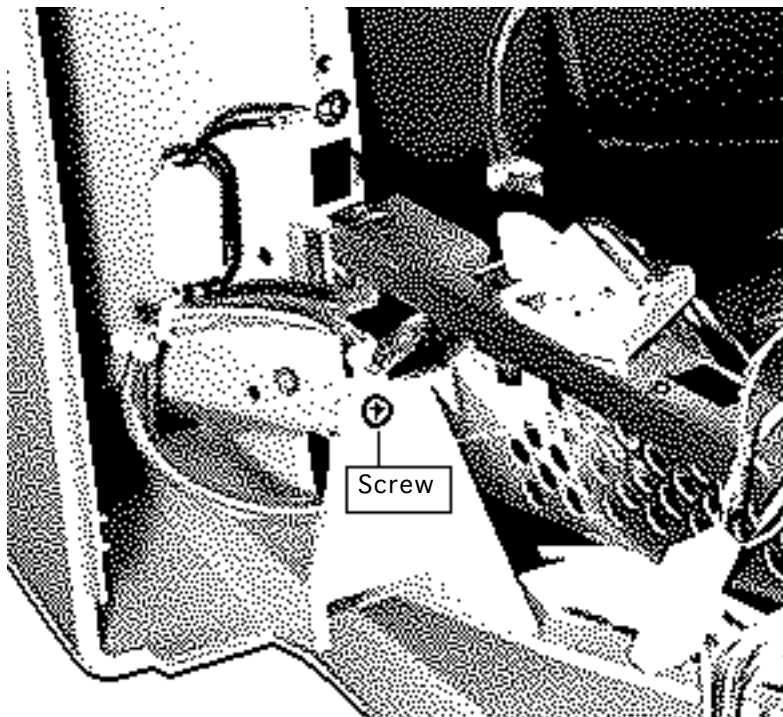

⚠ Warning: Never use a grounding wriststrap until after discharging the CRT.

- 1 With the monitor face-down on a protective pad, remove the two screws securing the tilt/swivel assembly to the chassis. (Only one screw is shown in the illustration. The other screw is on the opposite side of the tilt/swivel assembly.)
- 2 Lift and remove the tilt/swivel assembly.



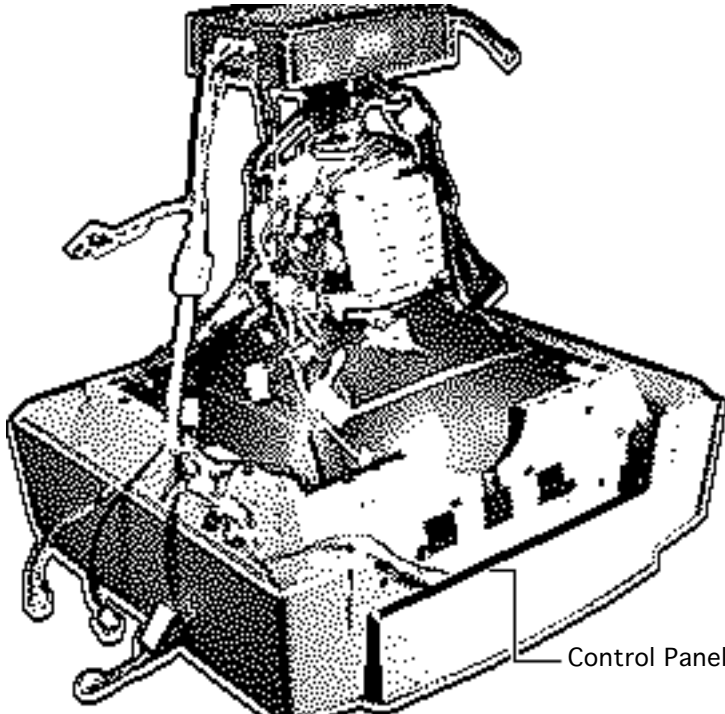

Control Panel

Control Panel

Before you begin,

- Remove the cover
- Discharge the CRT
- Remove the anode cap
- Remove the EMI shield
- Remove the power supply
- Remove the main deflection board
- Remove the tilt/swivel assembly





⚠ Warning: This product contains high voltage and a high-vacuum picture tube. To prevent serious injury, review CRT safety in Bulletins/Safety.

⚠ Warning: Never use a grounding wriststrap until after discharging the CRT.



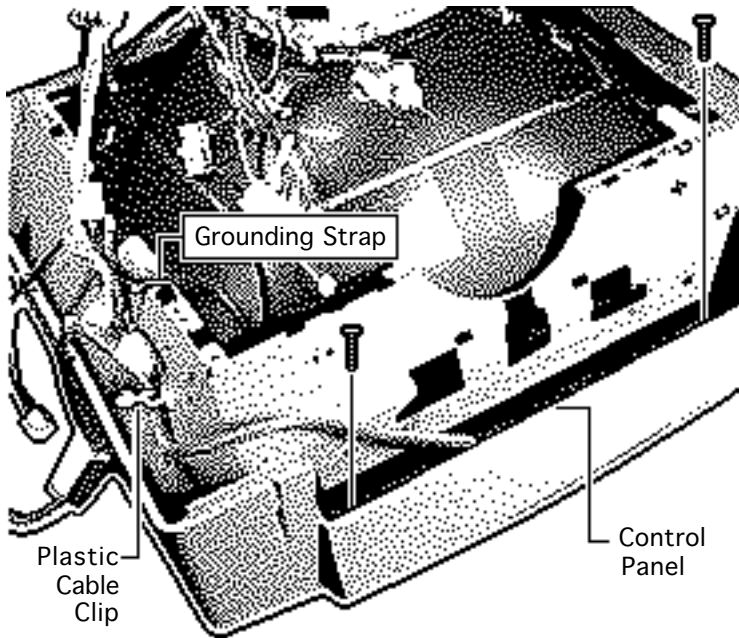

- 1 Remove the screw securing the control panel ground strap to the chassis.
- 2 Remove the ground wire from the plastic cable clip.
- 3 Remove the two screws securing the control panel board support to the front bezel.
- 4 Lift out the control panel board and support.





ADB Board

No preliminary steps are required before you begin this procedure.

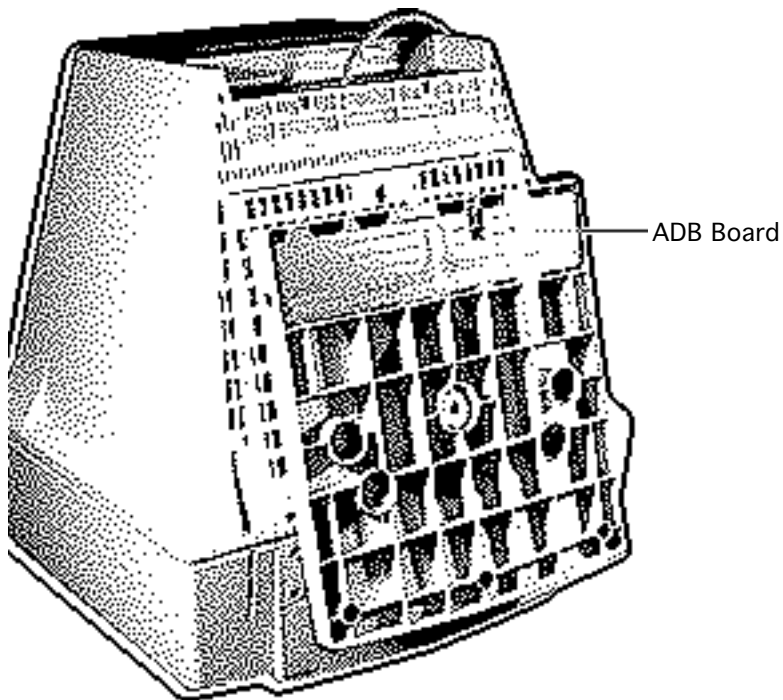

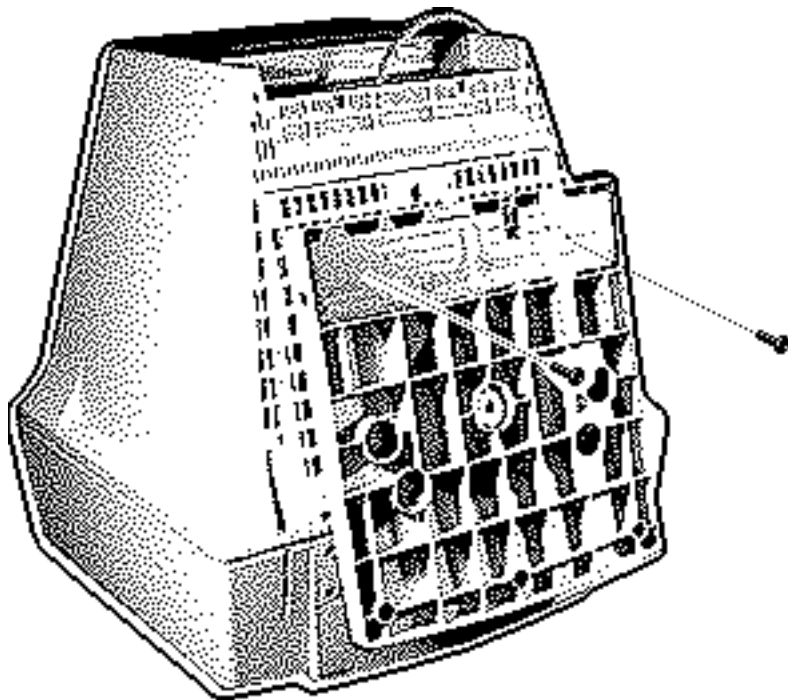

- 1 With the monitor face-down on a protective pad, remove the two screws securing the ADB board cover and remove the cover.
- 2 Lift out the ADB board.





Adjustments

Apple Multiple Scan 20 Display





Brightness and Contrast

No preliminary steps are required before you begin this procedure.

Adjustment controls are located on the front panel.

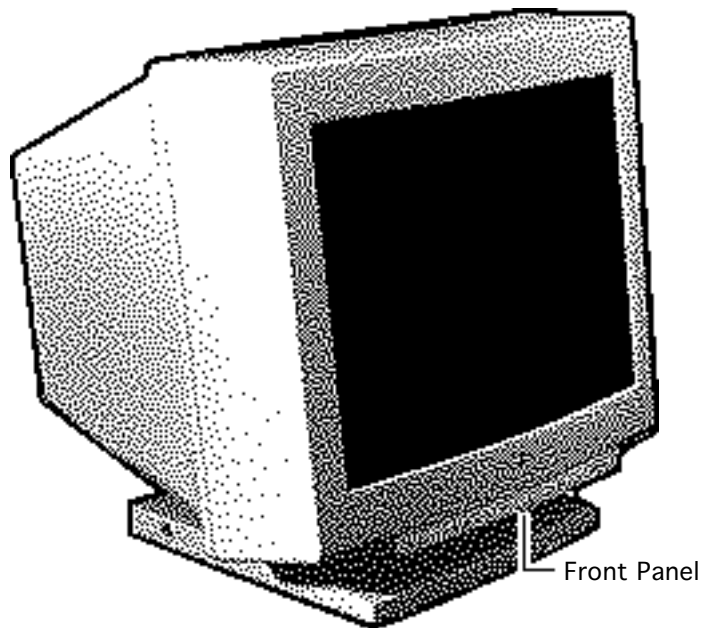



Brightness

- 1 Press the + button to increase the brightness.
- 2 Press the - button to decrease the brightness.

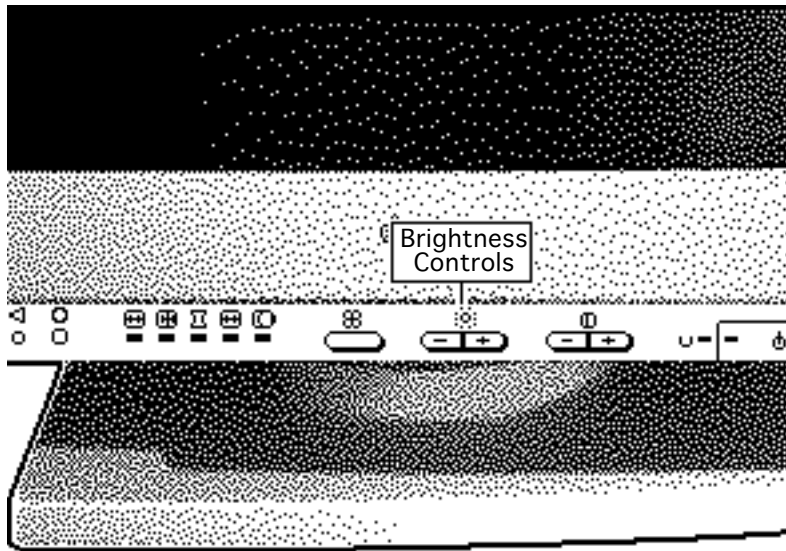



Contrast

- 1 Press the + button to increase the contrast.
- 2 Press the - button to decrease the contrast.

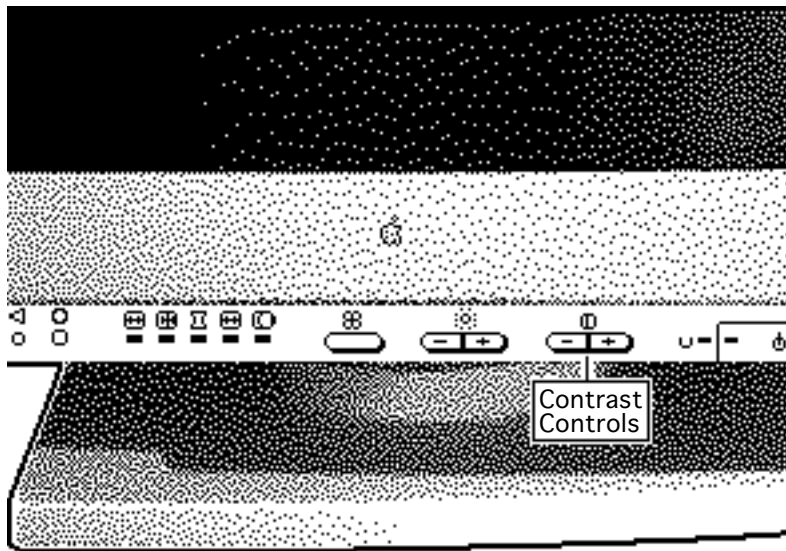



Geometry

No preliminary steps are required before you begin this procedure.

Adjustment controls are located on the front panel.

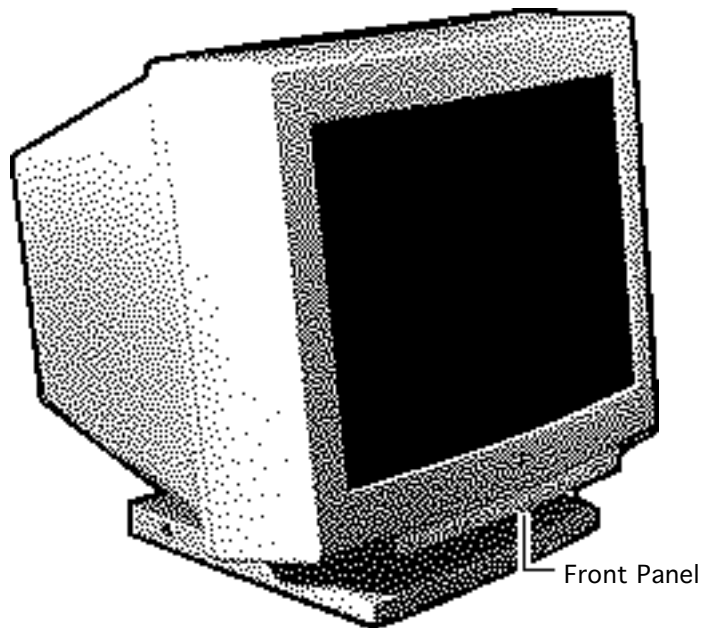

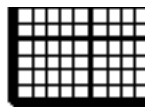

Crosshatch

Vertical Center

- 1 Press the select button to turn on the centering indicator light.
- 2 Press the + or - button on the brightness controls to move the center of the picture up or down.

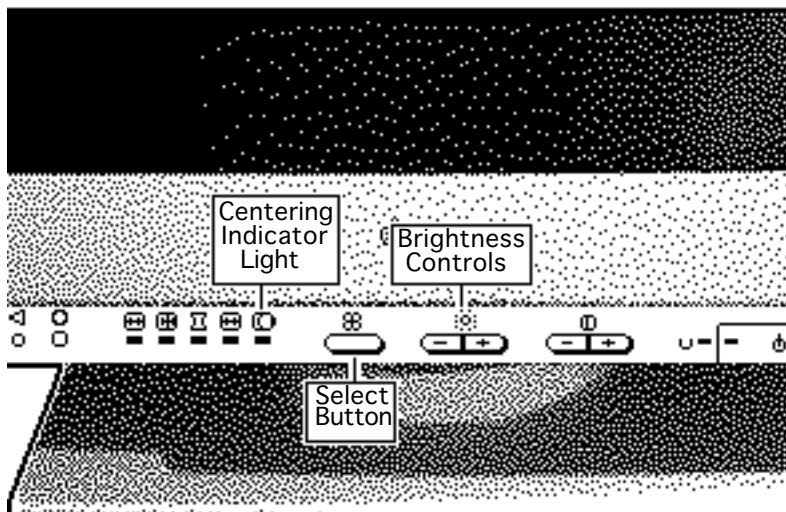

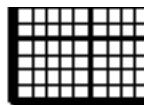

Crosshatch

Horizontal Center

- 1 Press the select button to turn on the centering indicator light.
- 2 Press the + or - button on the contrast controls to move the center of the picture right or left.

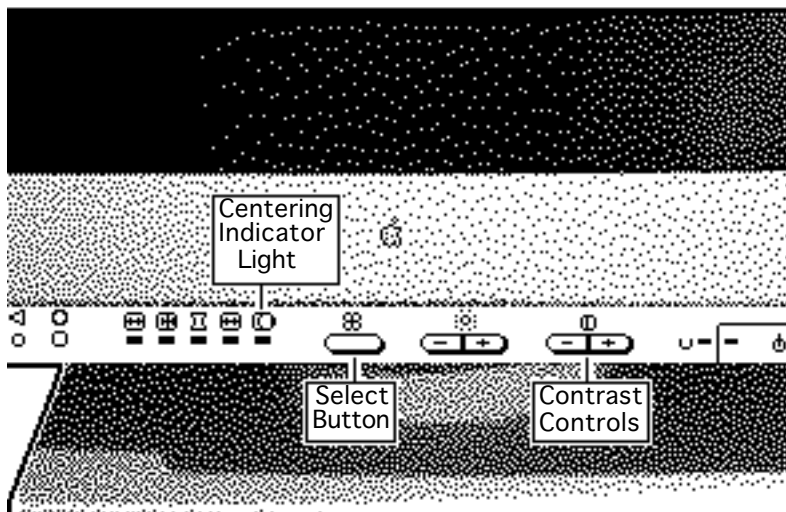

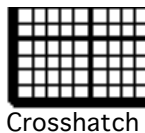

Crosshatch

Vertical Size

- 1 Press the select button repeatedly until the size indicator light goes on.
- 2 Press the + or - button on the brightness controls to increase or decrease the size of the picture.

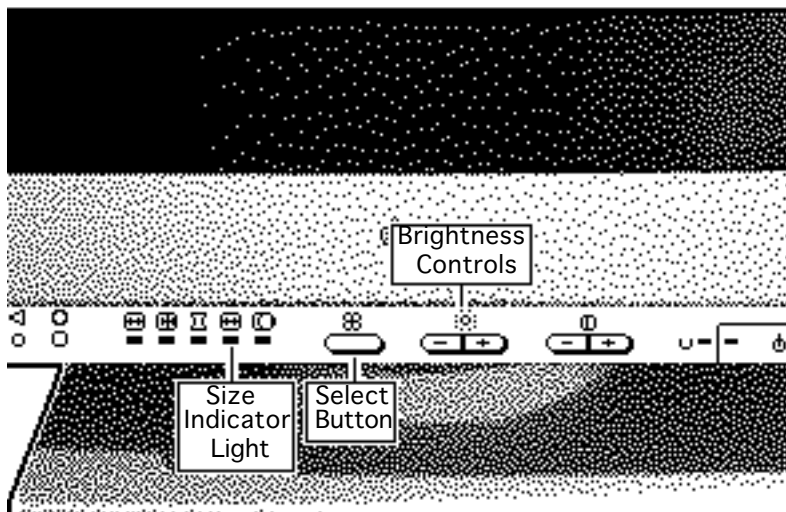

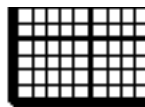

Crosshatch

Horizontal Size

- 1 Press the select button repeatedly until the size indicator light goes on.
- 2 Press the + or - button on the contrast controls to increase or decrease the size of the picture.

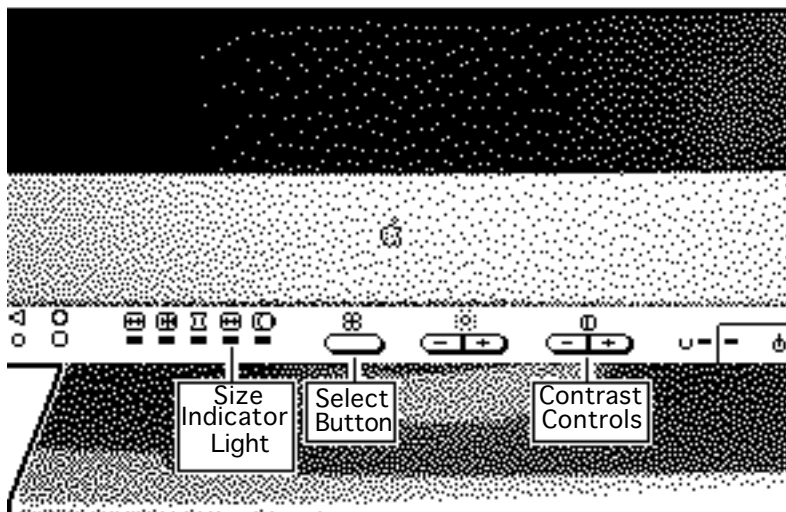

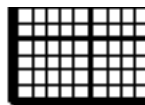

Crosshatch

Rotation and Color Uniformity

- 1 Press the select button repeatedly until the rotation indicator light goes on.
- 2 Press the + button on the brightness controls to tilt the picture clockwise.
- 3 Press the - button on the brightness controls to tilt the picture counterclockwise.

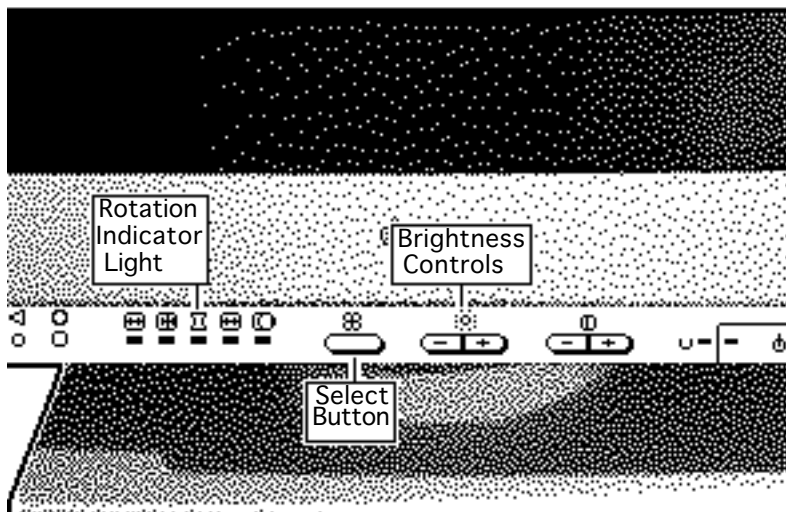



Note: When the picture rotates, the color uniformity also changes. Rotating the picture clockwise causes colors to darken on the lower right of the screen; rotating the picture counterclockwise causes colors to darken on the lower left. When rotation and color uniformity are set properly, the picture is rectangular and all four corners of the picture have consistent color.



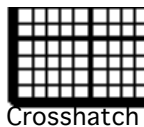

Shape

- 1 Press the select button repeatedly until the rotation indicator light goes on.
- 2 Press the + button on the contrast controls to expand the sides of the picture.
- 3 Press the - button on the contrast controls to bring in the sides of the picture.

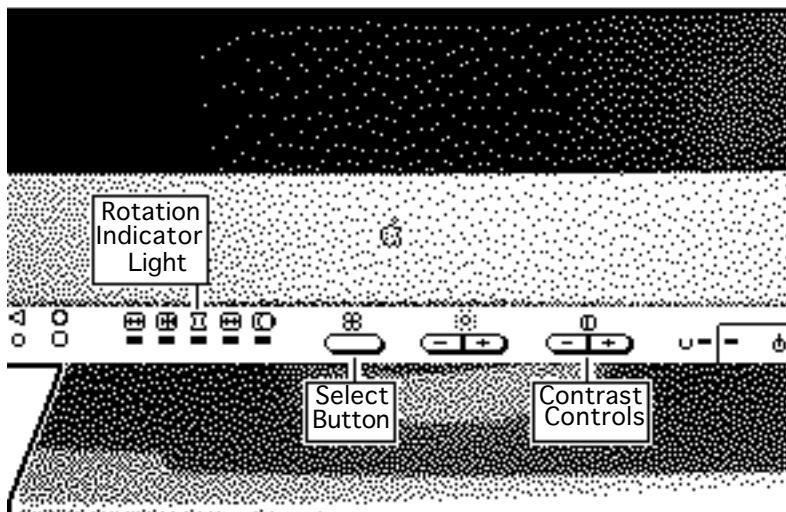



Convergence

No preliminary steps are required before you begin this procedure.

Adjustment controls are located on the front panel.

Note: When the convergence is set properly, the picture is crisp and clear.

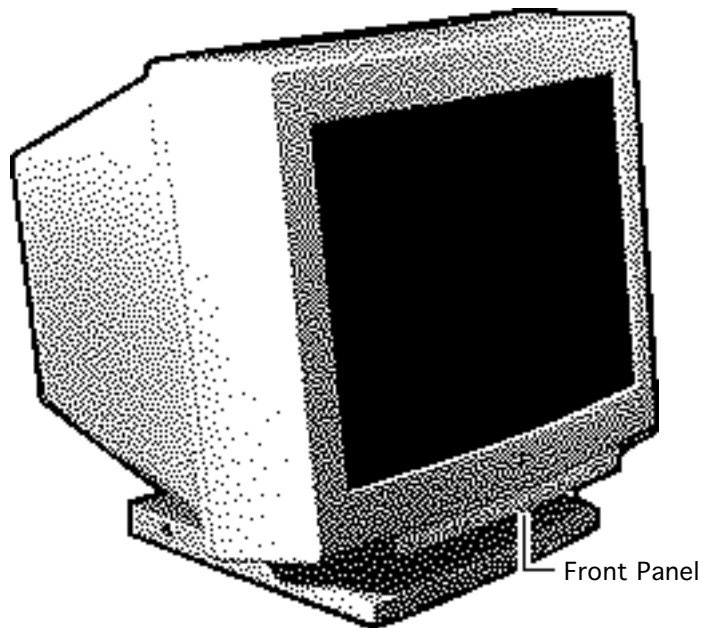

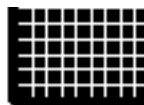

Crosshatch

Vertical Convergence

- 1 Press the select button repeatedly until the convergence indicator light goes on.
- 2 Press the + button on the brightness controls to move the red signal up and the blue signal down.
- 3 Press the - button on the brightness controls to move the red signal down and the blue signal up.

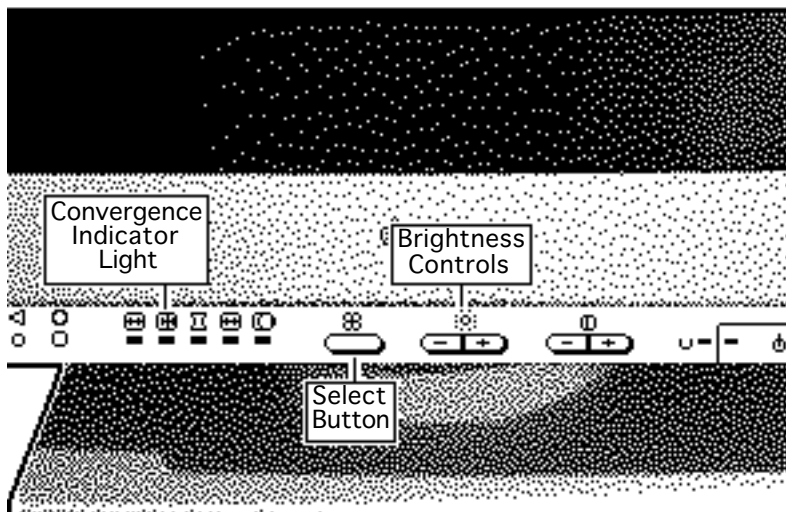

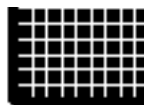

Crosshatch

Horizontal Convergence

- 1 Press the select button repeatedly until the convergence indicator light goes on.
- 2 Press the + button on the contrast controls to move the red signal to the right and the blue signal to the left.
- 3 Press the - button on the contrast controls to move the red signal to the left and the blue signal to the right.

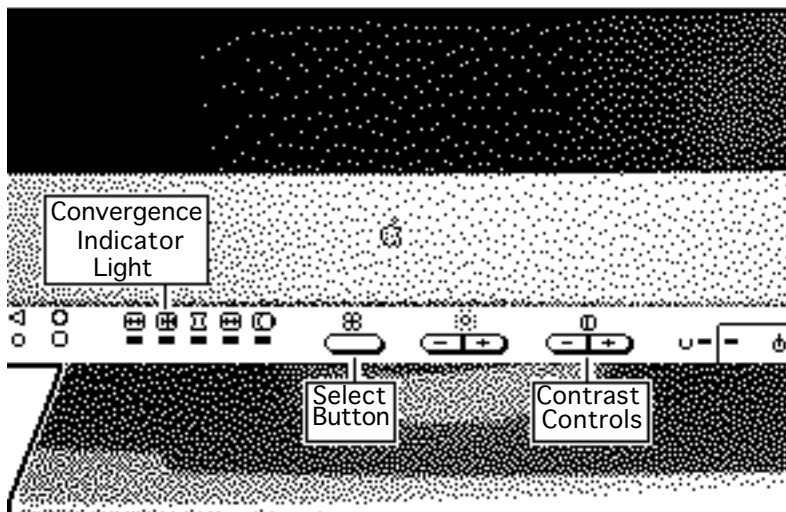



Color Temperature

No preliminary steps are required before you begin this procedure.

Color temperature refers to the intensity of the red/green/blue signals sent to the monitor. The color temperature settings are

- 9300 K: white appears bluish (default)
- 6500 K: white appears page white
- 5000 K: white appears reddish

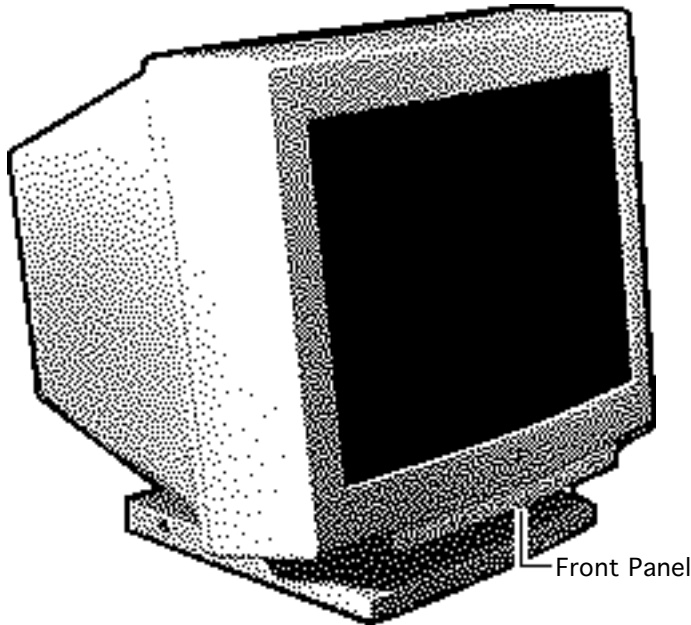



Color temperature can be changed to accommodate preference or application specifications.

Adjustment controls are located on the front panel.





- 1 Press the select button repeatedly until the color temperature indicator light goes on.

Note: The indicator may or may not blink, depending on the color temperature selected. A steady light indicates 9300 K, a slow blinking light indicates 6500 K, and a fast blinking light indicates 5000 K.

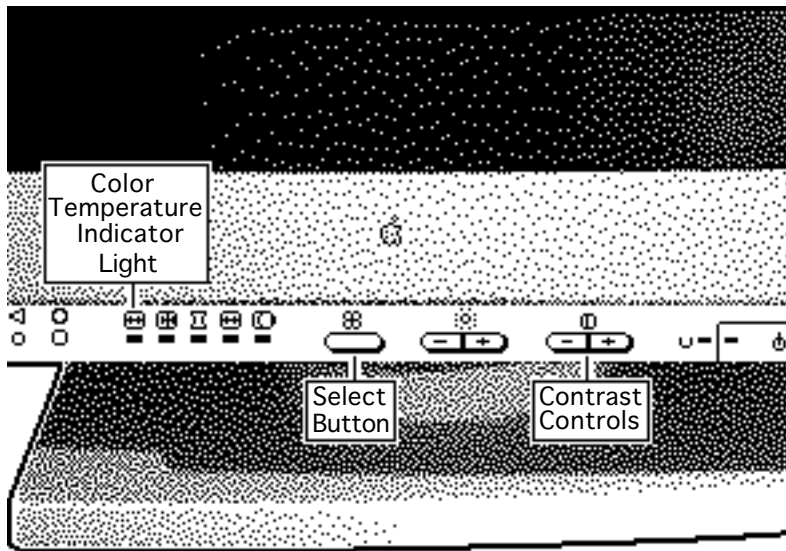

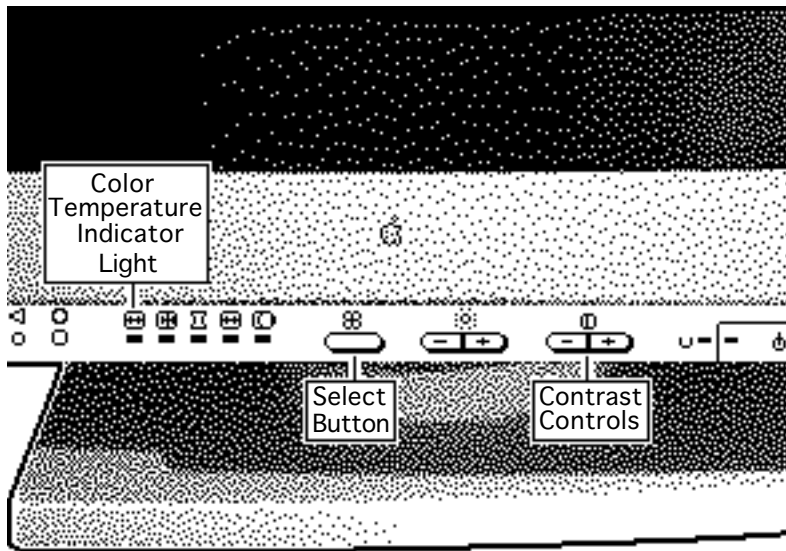

- 2 Press the + button on the contrast controls to increase the color temperature.
- 3 Press the - button on the contrast controls to decrease the color temperature.





Factory Settings

No preliminary steps are required before you begin this procedure.

Important: The monitor controls are set at the factory. To fine-tune and adjust the picture, use the front panel controls. The monitor will use your settings each time the computer is turned on. Use the recall function to return to factory settings.

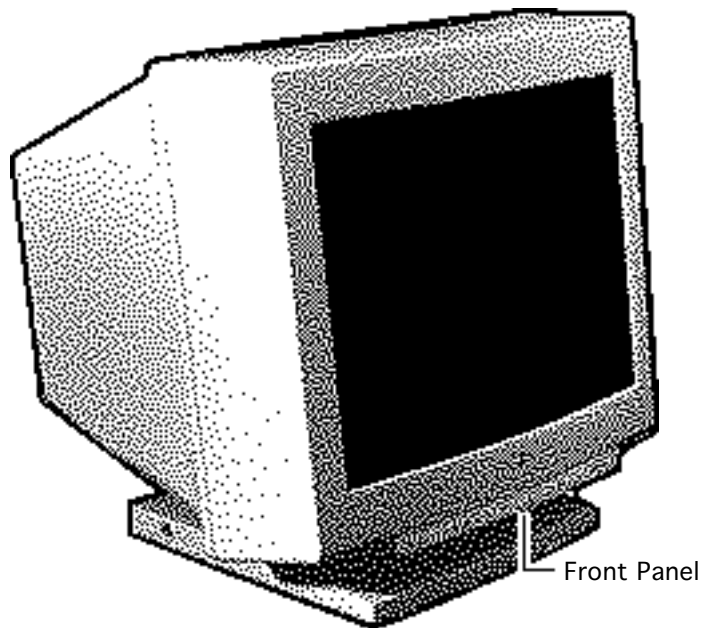



Recall

Note: You can reset brightness and contrast to their factory levels; however, you cannot reset one or the other. You must reset both controls.

Use a straightened paper clip to push in the reset button.

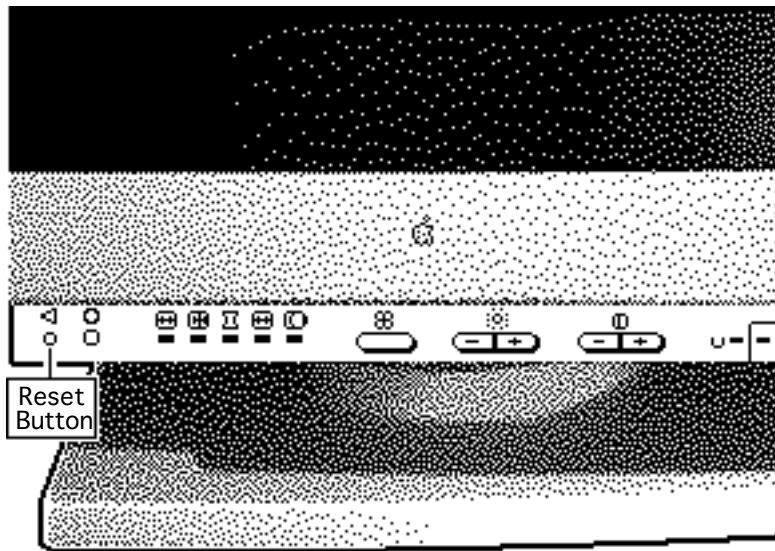

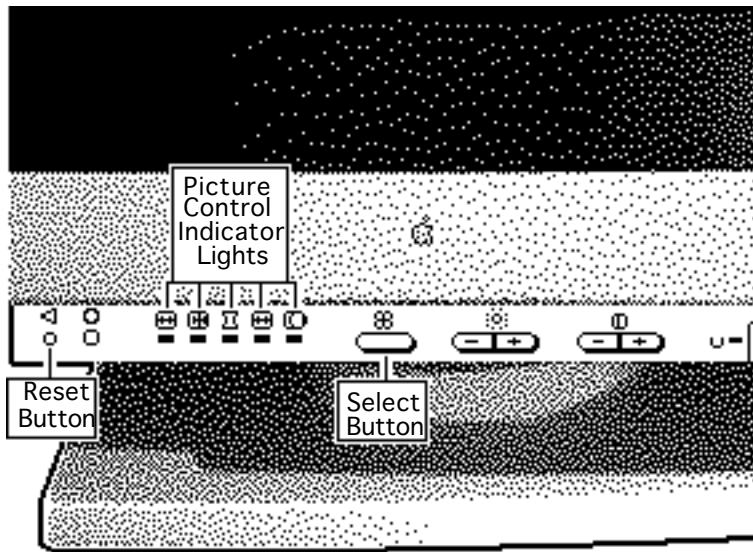

Reset a Specific Control

- 1 Press the select button repeatedly until the indicator light of the picture control you want to reset (vertical or horizontal center, convergence, or color temperature) goes on.
- 2 Use a straightened paper clip to push in the reset button.

The selected picture control is reset to its original level.





Reset All Controls

While holding down the control button, push in the reset button with a straightened paper clip.

All picture controls are reset to their factory levels.

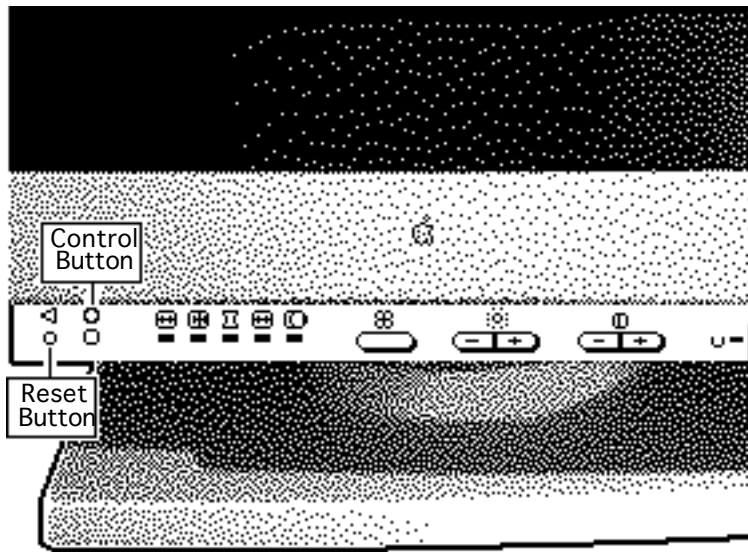



Exploded View

Apple Multiple Scan 20 Display



