



**Speco Internet Protocol (SIP)H.264
Series Camera Instruction Manual
(Version 1.0.0)**

SIP H.264 Megapixel Cameras
SIPMPBVFH & SIPMPDVFH

Table of Contents

1. FEATURES.....	1-1
1.1 Package.....	1-1
1.2 Dimension and Connector Description.....	1-2
1.2.1 Dimensions	1-2
1.2.2 Connector Description	1-4
2. INSTALLATION.....	2-5
2.1 Recommended PC Specification	2-5
2.2 Preparation before setup	2-6
2.2.1 Setup your PC network.....	2-6
2.3 Configuring the IP device.....	2-11
2.3.1 Video Display.....	2-13
2.3.2 Date & Time	2-16
2.3.3 Network Section	2-18
Host.....	2-19
IP Address Filtering	2-20
Port Mapping	2-22
ToS.....	2-24
UPnP™	2-25
SNMP Setting	2-26
RTP	2-26
Speed & Duplex	2-28
2.3.4 IP Settings.....	2-29
Connection Type.....	2-29
DNS	2-31
DDNS	2-32
2.3.5 Video & Audio	2-33
Video.....	2-33
2.3.6 System	2-51
User Account	2-51
System Info	2-52
Factory Default	2-53
Firmware Upload	2-54

Profile Upload.....	2-55
Save & Reboot.....	2-56
Logout.....	2-56
APPENDIX.....	2-57
3.1 Specification.....	2-57
3.1.1 SIP H.264Camera Series	2-57

1 FEATURES

1.1 Package



SIPMPBVFH Camera



SIPMPDVFH Camera



Software CD



Quick Install Guide



Cross LAN Cable



Accessory Pack



Power Lead Cable

Package of Products is composed of the main body of the camera, Software CD (NVR Program, Product Manual, NVR Manual), Quick Install Guide, Cross LAN Cable, Accessory Pack, Power Lead Cable.

Please check before starting installation.

1.2 Dimension and Connector Description

1.2.1 Dimensions

1. SIPMPBVFH

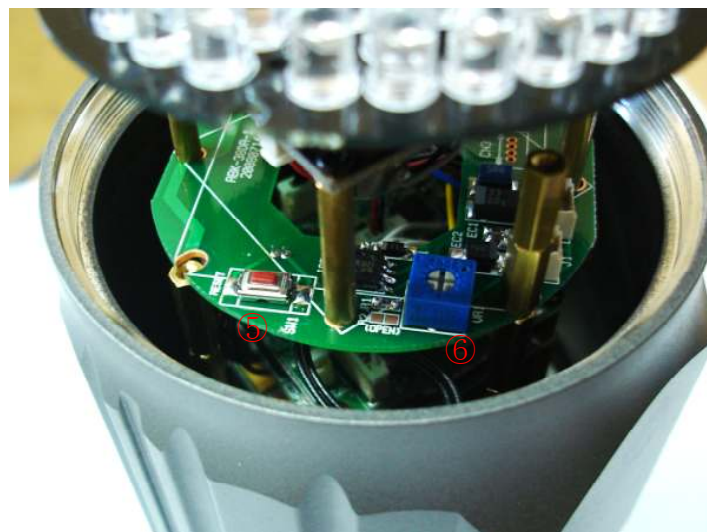
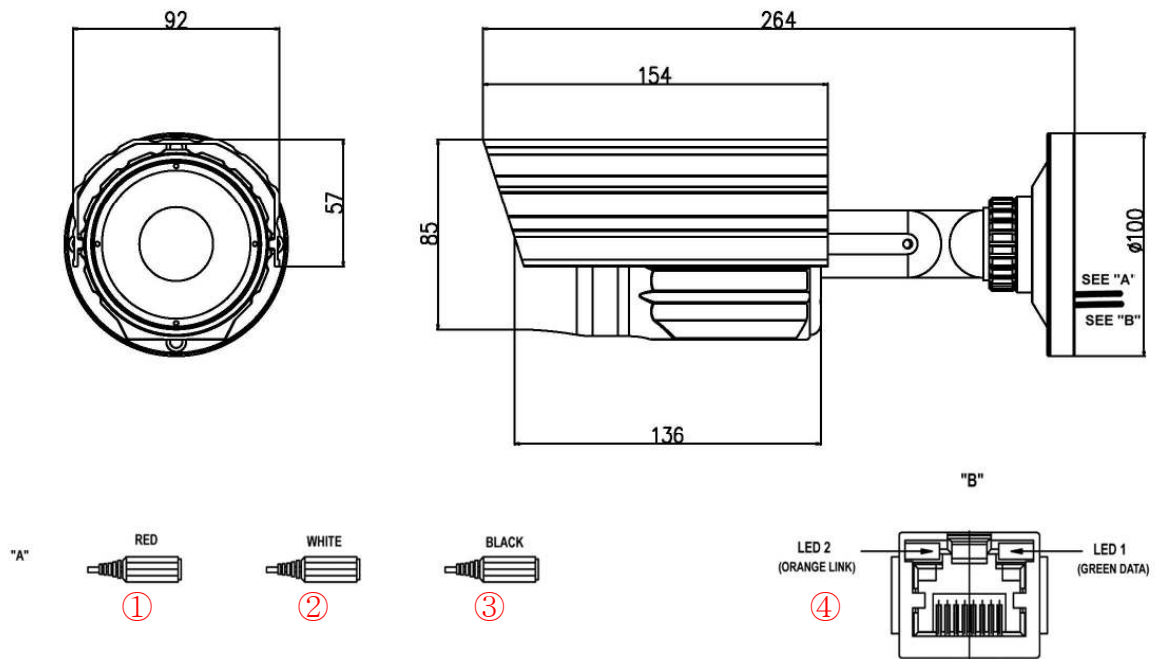

2. SIPMPDVFH

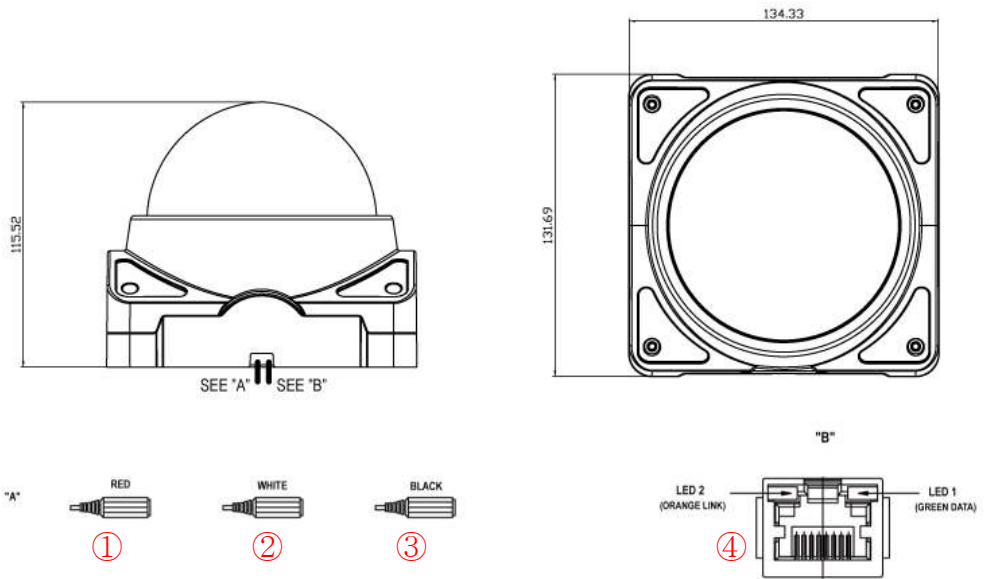

1.2.2 Connector Description

① **12 Volts DC Power Input**

② **Audio Output**

③ **Audio Input** : The SIP Camera supports one audio input and output

④ **Ethernet Port** : Standard RJ45 connector. Supporting POE.

⑤ **Reset Button** (** Please open the case for the Bullet / Dome type camera)

Step 1 : Switch off SIP Camera by disconnecting the power cable.

Step 2 : Using a suitable pointed object, press and continue to hold the Reset Button. While continuing to hold the reset button, reconnect the power cable.

Step 3 : Keep holding the reset button for 6 seconds, release the reset button.

The unit will start up with factory default settings.

⑥ **LED Light level controller**

2 INSTALLATION

2.1 Recommended PC Specification

CPU	Core2Duo 2.13GHz and above
Memory	2 GB or above
Operating System	Windows XP with SP2 or above. Windows Vista / Windows 2003 / Windows 7
Video Resolution	Internet Explorer 6.0 SP2 and above. SVGA or XGA with 1024x768 resolution
CPU	Core2Duo 2.13GHz and above

2.2 Preparation before setup

To configure your IP device, you have to use Internet Explorer to log in. Before that, your PC's network settings and the IP device's IP address must be set up. Make sure all the connections are connected correctly, and then follow the procedures below.

1. Setup your PC network

You have to match your PC's TCP/IP setting with the IP device's default settings before you can use IE browser to login it. This section tells you how to setup your PC's TCP/IP settings.

2. Setup IP device's IP address

This IP device's IP address can be setup manually or automatically by network service (DHCP). If it acquires the IP address by using the DHCP service, please use the IP utility software bundled in the product CD to search all the IP devices' IP address.

2.2.1 Setup your PC network

To set up the network of IP device via a PC, you have to change the TCP/IP settings of the PC.

The following are the default network settings of IP device.

IP Address: 192.168.0.100

Subnet Mask: 255.255.255.0

To access the IP device, the IP address of the PC should match the address below.

IP Address: 192.168.0.xxx

Subnet Mask: 255.255.255.0



NOTE: xxx should be a number from 1 to 254, but 100 is excepted.

The procedure below is the setup procedure of a PC using Windows XP as its OS. When running an OS other than Windows XP, please refer to the manual included with the OS.

- **STEP 1**
Start up your PC.
- **STEP 2**
Click the [Start] and select the "Control Panel"

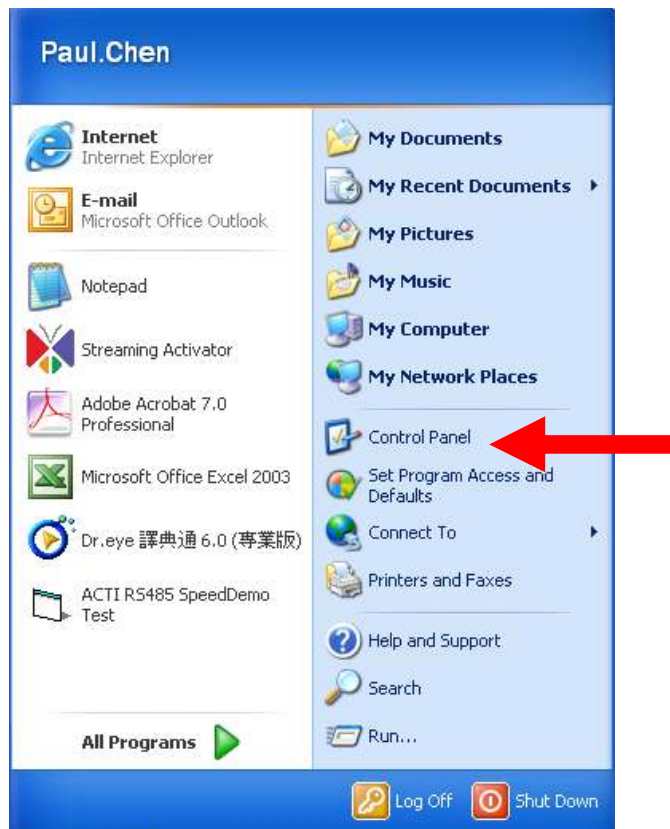

- **STEP 3**

Double-click the "Network and Internet connections" icon.

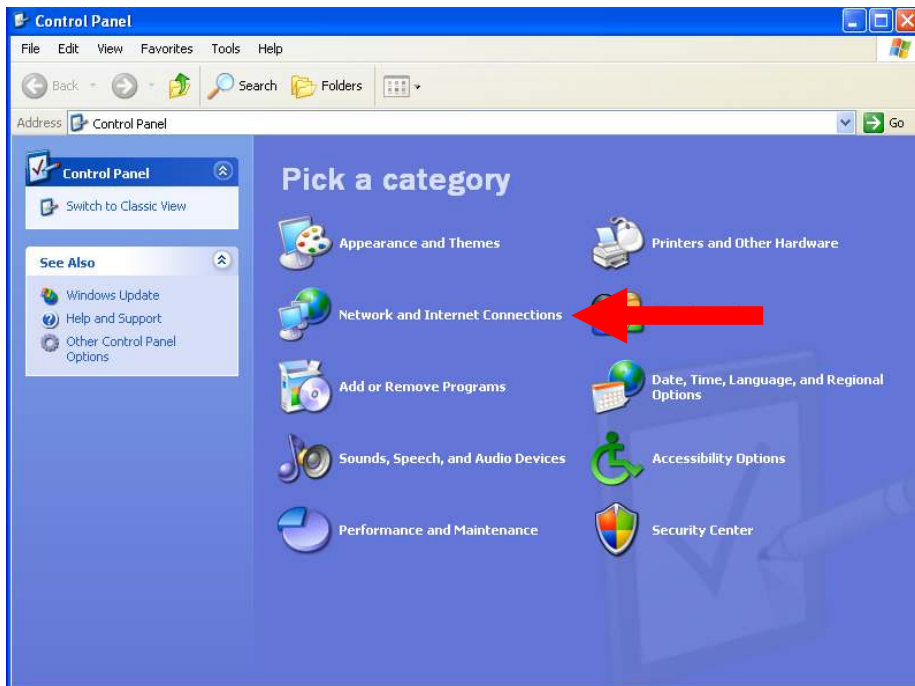

- **STEP 4**

Double-click the "Network connections" icon

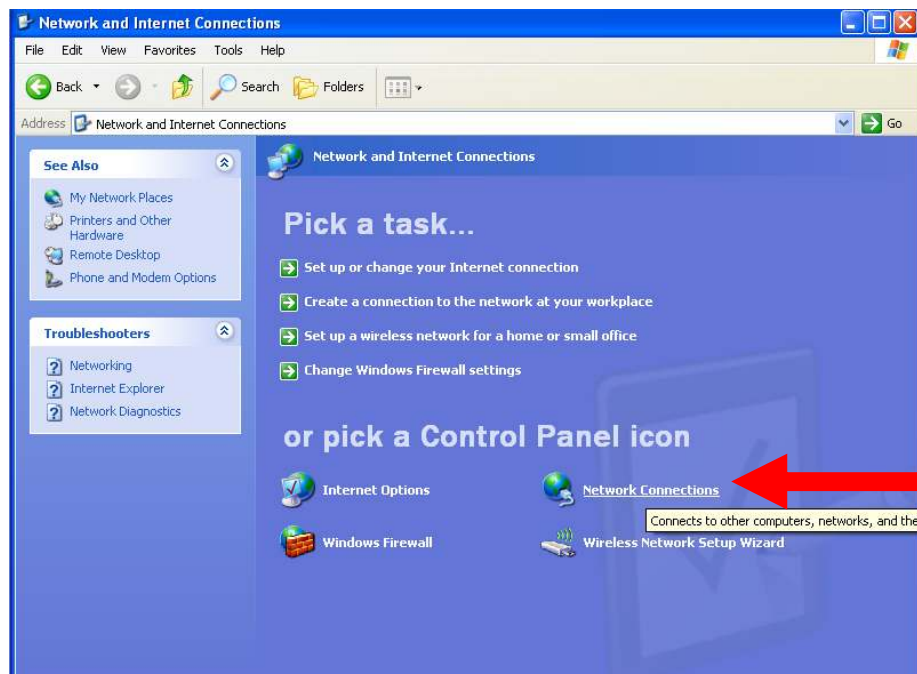

- **STEP 5**

Click “Local Area Connections”, and then click “Change settings of this connection” in the network Task menu.

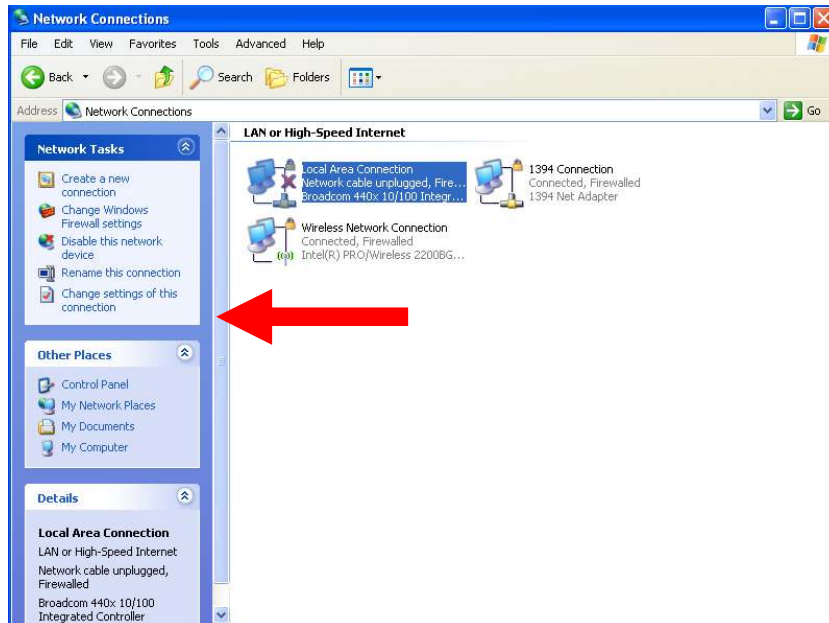

- **STEP 6**

Click “Internet Protocol (TCP/IP)”, and then click the [Properties] button.

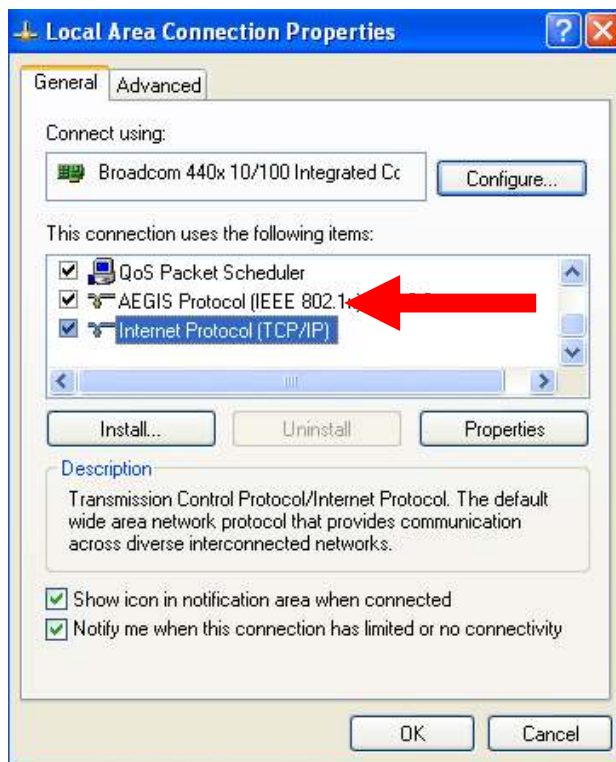

- **STEP 7**

Click the “Use the following IP address” radio button and enter the IP address and the subnet mask.

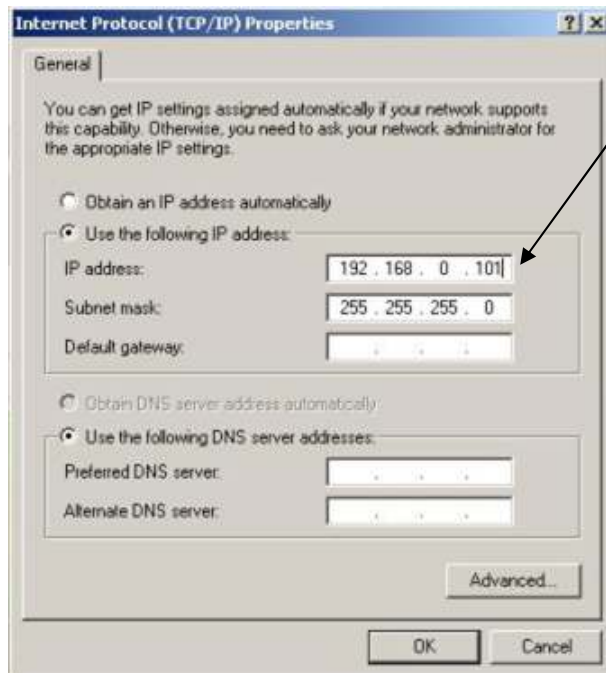

Please set the settings as below.

IP address: 192.168. 0.xxx
Subnet mask: 255.255.255. 0

(NOTE: xxx should be a number from 1 to 254, but 100 is excepted.)

- **STEP 8**

Click the [OK] button and the window dialog box closes.

2.3 Configuring the IP device

This section describes how to configure the IP device. The product administrator has unlimited access to all setup windows and normal users can only watch the live image. The IP device is configured under a standard browser (Microsoft Internet Explorer 6.0 or above).

Follow the procedures below to configure the IP device.

- **STEP 1:** Open a browser
- **STEP 2:** Enter the IP address of the IP device.

The default IP address is “192.168.0.100”

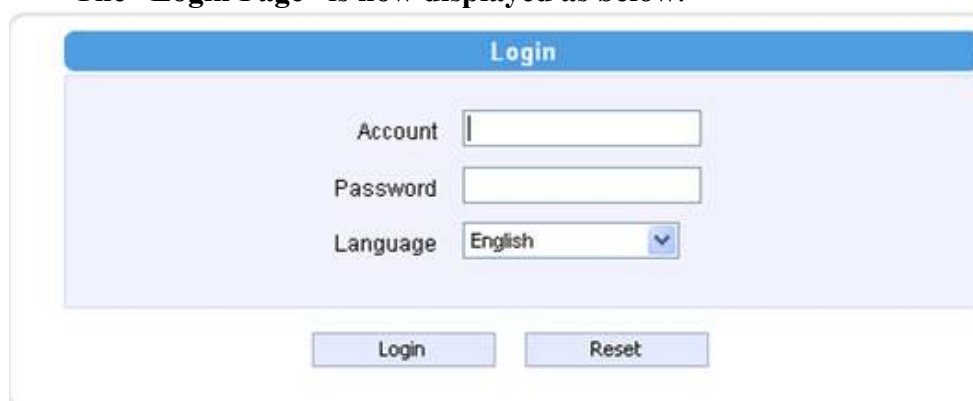

The “Login Page” is now displayed as below.



- **STEP 3:** Enter the Account name (factory default: Admin) and the Password (factory default: 123456).



NOTE: Internet Explorer of 6.0 or above is highly recommended. If you don't have the it, please download it from <http://www.microsoft.com/windows/ie/downloads/default.msp>

- **STEP 4:** Select the language of the IP device user interface. You can select from English, Traditional Chinese, Simplified Chinese, Japanese, Spanish, Italian, German, Portuguese, Czech and French. This user interface setting will disappear once you log out, if you want to change the default user interface language, please change the setting of [Host setting] after login success.
- **STEP 5:** Click the  button to login or click the  button to re-enter again.

Once successfully login, the “Video Display page” will be displayed as below.

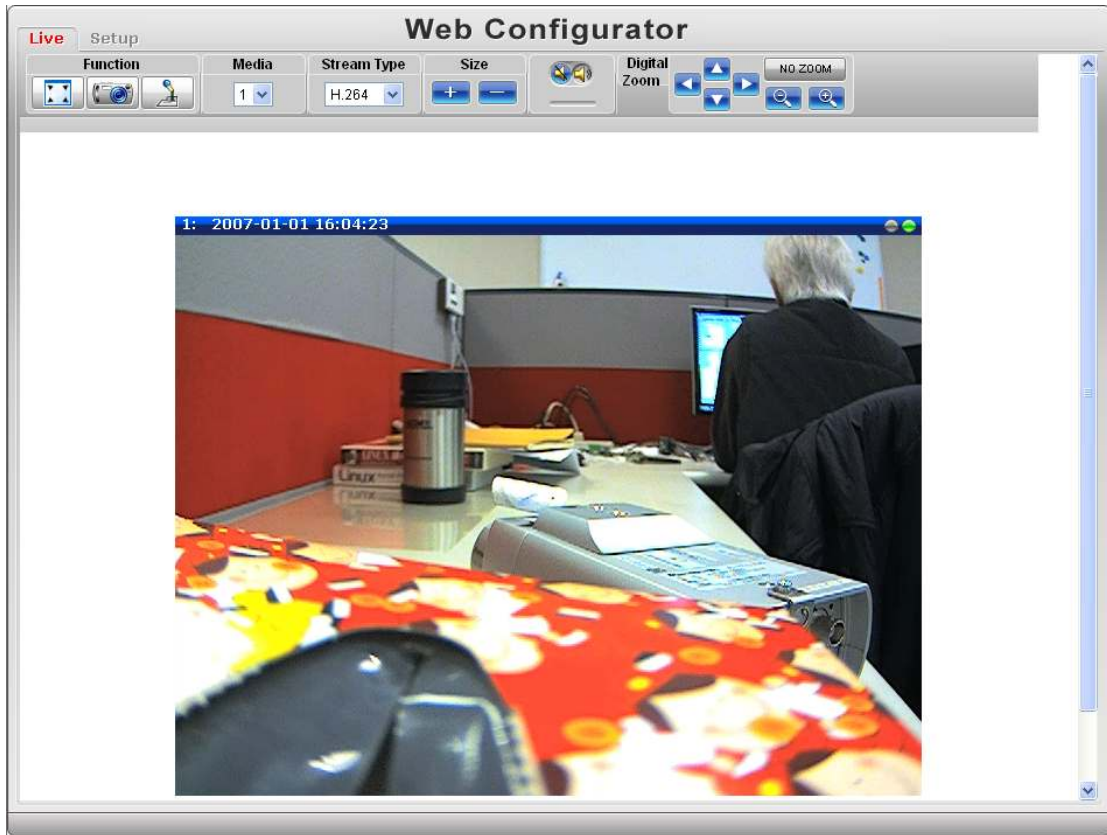



2.3.1 Video Display











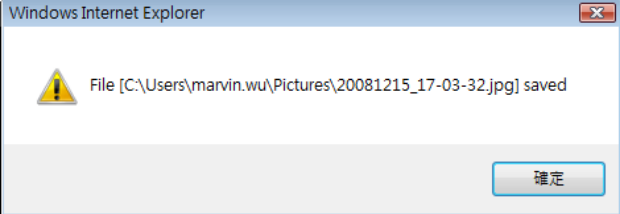

This section tells you how to view live images via Internet Explorer.





Click the **1** [Live] tab to show [Live page]. Refer to the table below for how to configure each setting.



Function List

Function	Description
2 Full Screen	Click the icon  to stretch the preview to full screen. You can click “Esc” button on the keyboard to return to previous display.
3 Snapshot	Click the icon “  <p>2-13</p>

	
<p>4 Audio out</p>	<p>Click the icon  to enable the audio out from PC to IP camera or video server. When it is enabled, your voice will be transferred to the audio out of the IP camera or video server.</p> <p>NOTE: you will need to have a microphone connected to your PC to do that.</p>
<p>5 Media</p>	<p>If dual stream mode is enabled, click 5 to select which stream to display (Media 1 or 2). The default is single stream only. To change to dual stream mode, please refer to “Media 1” section under “Setup” tab</p>
<p>6 Encoder Type</p>	<p>Click 6 to select the compression codec used in video encoding. The Encoder type option includes MPEG-4, MJPEG and H.264. Once selected, the video server/IP camera will start to send video in new stream type.</p>
<p>7 Display size</p>	<p>Click  or  of 7 to adjust 16 display screen size</p>
<p>10 Audio in</p>	<p>Click the icon  8 to mute or the icon  9 to receive audio in from the video server/IP camera. Drag the volume bar  10 to adjust the volume.</p>
<p>11 Digital Zoom</p>	<p></p> <p>Digital zoom enables you to zoom into the image. You can click 13  to zoom in and click 12  to zoom out. You can click the  14 “no zoom” button to cancel all zoom-in and go back to original status (no zoom status).</p> <p>When you digitally zoom in the video, you can click  to pan/tilt the video up, down, left and right.</p> <p>NOTE: This pan/tilt function does not work if the video is</p>

	not zoomed-in (no zoom status).
17 Network status	 Indicates the network state. If the light on the right is green, it means the network is ok. If the light is gray, it means the network is broken. The light on the left is not used
DO Setting	 Click  to set DO output level to High. Click  to set DO output level to Low. If your device has more than one DO available, each DO is controlled separately.

If you want to setup this IP camera/video server, please click the  [Setup] tab to switch to “Setup Page”

2.3.2 Date & Time

This section tells you how to setup IP device's date and time settings.

- **STEP 1:** Click the [Date & Time] on the “Main Setup page”.

The “Date setting page” is displayed as below

- **STEP 2:** Configure these settings with reference to the table below. If you are still unsure what to set, contact your system administrator.

Date Setting

Parameters	Description
1 SNTP/NTP server	Click this to enable IP device's SNTP/NTP function. This enables this IP device to synchronize its time settings with a SNTP/NTP server. You can use this function to make sure all your IP devices' time is the same. Additionally, with our embedded digital-time-code in the streaming, you can tell the event sequence accurately. 2 IP address: Enter the IP address of the SNTP/NTP server. 3 Sync time: Select the time interval for this IP device to synchronize its time.
4 Set	Click this to manually setup the date & time.

manually	<p>5 Date : Select the date</p> <p>6 Time: Select the time</p>
7 Time zone	Select the time zone offset for local settings
8 Day Light Saving	<p>Select Type 1 9 to specify daylight saving time by week number in a month; select Type 2 to specify daylight saving time by date.</p> <p>10 Start Time: Select the daylight savings start time.</p> <p>11 End Time: Select the daylight savings end time.</p>

Click the **12** [Apply] button to confirm the settings or click the **13** [Reset] button to re-enter the parameters.

2.3.3 Network Section

Click the [Network] item on the “Setup Page”.



Host

Click the [Host] to enter Host settings page. Refer to the table below for how to configure each setting.

Host

1 Host Name ACTi

2 Language English

3 Camera Name Camera-1

4 Apply Reset 5

Parameters	Description
1 Host name	Enter a host name, and this host name will be shown when you use the IP utility or the SDK to search for the IP device.
2 Language	Select the language of default user-interface. Each user login will see the default user-interface first.
3 Camera name	The camera name is reserved for customer use.

Click the 4 [Apply] button to confirm the settings or click the 5 [Reset] button to re-enter the parameters.

IP Address Filtering

WARNING: Please be very careful when using this function, as you may lose access to your camera if you make mistakes in setup. You may either accidentally deny yourself access, or forgot to include your own IP address in the allowed address list. You will need to perform hard reset to be able to

Click the [IP Address Filter] item to display the “IP Address Filtering Page”. Refer to the table below for how to configure each setting.

IP Address Filtering

1 IP address filter enable

Set IP address -----

2 Blocked ▾ IP Address/Netmasks

NO.	IP address	Netmask	Enabled
3 1	0 . 0 . 0 . 0	4 0 . 0 . 0 . 0	5 <input type="checkbox"/>
2	0 . 0 . 0 . 0	0 . 0 . 0 . 0	<input type="checkbox"/>
3	0 . 0 . 0 . 0	0 . 0 . 0 . 0	<input type="checkbox"/>
4	0 . 0 . 0 . 0	0 . 0 . 0 . 0	<input type="checkbox"/>
5	0 . 0 . 0 . 0	0 . 0 . 0 . 0	<input type="checkbox"/>
6	0 . 0 . 0 . 0	0 . 0 . 0 . 0	<input type="checkbox"/>
7	0 . 0 . 0 . 0	0 . 0 . 0 . 0	<input type="checkbox"/>
8	0 . 0 . 0 . 0	0 . 0 . 0 . 0	<input type="checkbox"/>
9	0 . 0 . 0 . 0	0 . 0 . 0 . 0	<input type="checkbox"/>
10	0 . 0 . 0 . 0	0 . 0 . 0 . 0	<input type="checkbox"/>
11	0 . 0 . 0 . 0	0 . 0 . 0 . 0	<input type="checkbox"/>
12	0 . 0 . 0 . 0	0 . 0 . 0 . 0	<input type="checkbox"/>
13	0 . 0 . 0 . 0	0 . 0 . 0 . 0	<input type="checkbox"/>
14	0 . 0 . 0 . 0	0 . 0 . 0 . 0	<input type="checkbox"/>
15	0 . 0 . 0 . 0	0 . 0 . 0 . 0	<input type="checkbox"/>
16	0 . 0 . 0 . 0	0 . 0 . 0 . 0	<input type="checkbox"/>

6 Apply 7 Reset

Parameters	Description
1 IP address filter enable	Check this box to enable IP Address Filtering.
2 Filter Method	The filter can be set in either “Allow” mode or “Block” mode. 1. “Allow” mode will refuse access to all IP addresses except the ones listed below. 2. “Block” mode will accept all incoming access except the IP addresses listed below. Make sure you include the Netmask in your consideration.
3 IP Address	The IP address you wish to allow or block. Please note that the actual range is modified by the Netmask.
4 Netmask	Using Netmask allows you to set filtering for a whole range of IP address at once, without the need to enter all of them individually. If you are not sure about the function of netmask, then you should use 255.255.255.255, and it will affect only a single IP address per line of entry, or use 255.255.255.0 to use the same setting for all IP addresses starting with the same three numbers. .
5 Enable	For each entry, you must check this box for it to be effective. For an entry that you no longer need but does not wish to delete, you can uncheck it, and the system will remember it for future use. If a new entry that has never been used before does not have Enable checked, then it will not be stored in memory.
6 Apply	Click this to use the current displayed info to do IP Address filtering. If you setup correctly, it will change into a grayed out “Success” in a few seconds.
7 Reset	Click this button to re-enter the parameters.

Click the **6** [Apply] button to confirm the settings or click the **7** [Reset] button to re-enter the parameters.

Port Mapping

Click the [Port Mapping] item to display the “Port Mapping Page”. Refer to the table below for how to configure each setting.

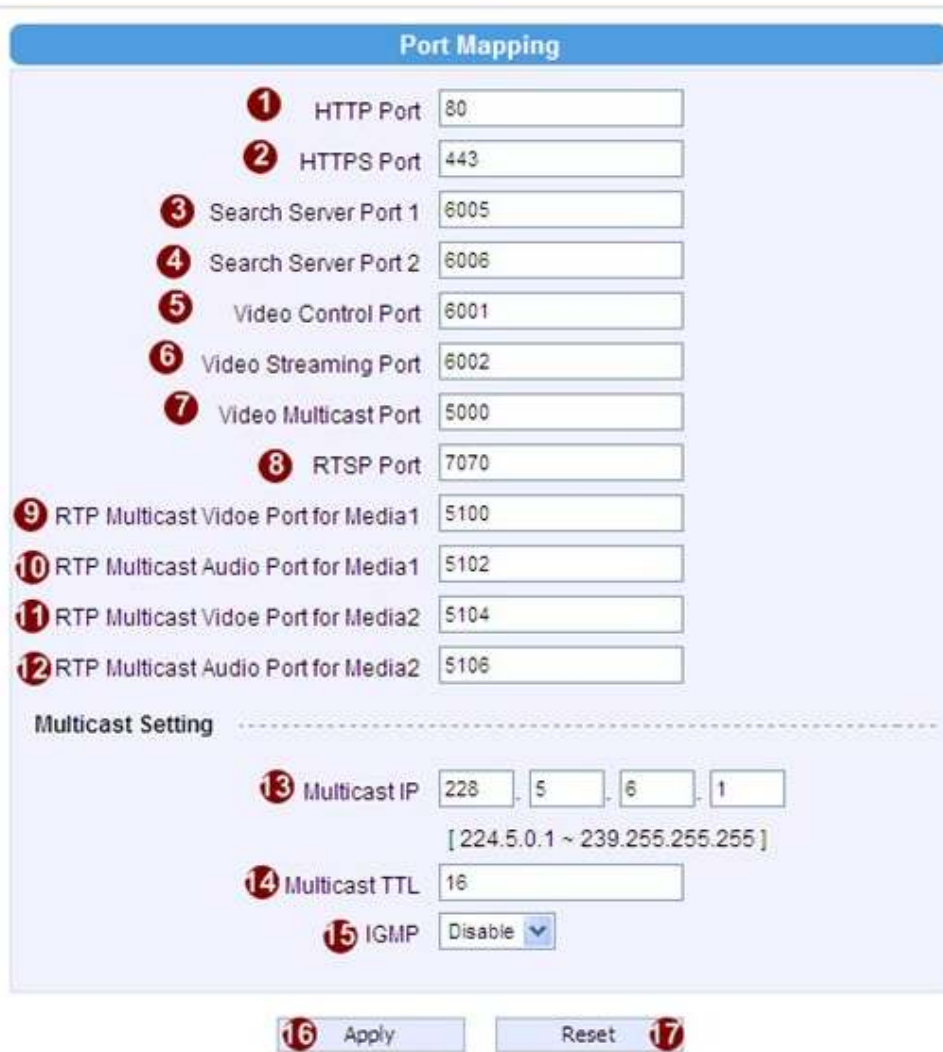

Parameters	Description
1 HTTP port	Select the port assigned for HTTP protocol access
2 HTTPS	Select the port assigned for HTTPS protocol access
3 Search server port1	Select the first port used by server search applications to detect this IP device. (e.g. IP utility)
4 Search server port2	Select the first port used by server search applications to detect this IP device. (e.g. IP utility)
5 Video control port	Select the port used to support video control function by application programs. (e.g. NVR)

6 Video streaming port (TCP Only)	Select the port used by this IP device for Video Streaming.
7 Video Multicast Port	Enable/disable multicast audio streaming
8 RTSP port	Select the port assigned for RTSP protocol access
9 RTP Multicast Video Port for Media1	Select the port for the multicast video streaming of media1 via RTP protocol
10 RTP Multicast Audio Port for Media1	Select the port for the multicast audio streaming of media1 via RTP protocol
11 RTP Multicast Video Port for Media2	Select the port for the multicast video streaming of media2 via RTP protocol
12 RTP Multicast Audio Port for Media2	Select the port for the multicast audio streaming of media2 via RTP protocol
13 Multicast IP	Select the multicast IP. Default settings is 228.5.6.1
14 Multicast TTL	Select the multicast TTL. Default setting is 255.
15 IGMP	Select video type connected to the video-in of this IP device. If you use an incorrect video type, some images might be lost.

Click the **16** [Apply] button to confirm the settings or click the **17** [Reset] button to re-enter the parameters.

ToS

Click the [ToS] (Type of Service) item to display the “ToS Page”. Refer to the table below for how to configure each setting.

The screenshot shows a configuration window titled "Type of Service". It contains two dropdown menus. The first dropdown, labeled "Type of Service", is currently set to "Disabled" and is marked with a red circle containing the number 1. The second dropdown, labeled "ToS Priority", is currently set to "Normal Service" and is marked with a red circle containing the number 2. Below these dropdowns are two buttons: "Apply" (marked with a red circle containing the number 3) and "Reset" (marked with a red circle containing the number 4).

Parameters	Description
1 TOS (type of service)	Select whether to add the TOS tag onto the streaming data. Streaming data with a higher priority TOS tag will be transmitted first when compared with other data.
2 TOS priority	Select the TOS tag's priority to be added onto the streaming. You can select between 1. Minimize-Delay 2. Maximize-throughout 3. Maximize-Reliability 4. Normal-Service

Click the **3** [Apply] button to confirm the settings or click the **4** [Reset] button to re-enter the parameters.

UPnP™

Click the [UPnP™] item to display the “UPnP™ Setting Page”.

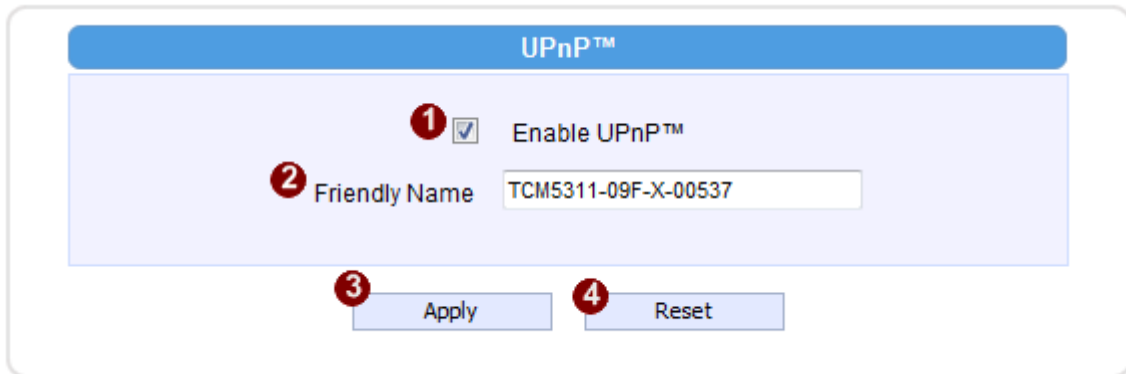

The screenshot shows the UPnP™ Setting Page. It features a blue header with the text "UPnP™". Below the header, there is a checkbox labeled "Enable UPnP™" with a red circle "1" next to it. Below that is a text field labeled "Friendly Name" with a red circle "2" next to it, containing the text "TCM5311-09F-X-00537". At the bottom, there are two buttons: "Apply" with a red circle "3" and "Reset" with a red circle "4".

Click checkbox **1** to enable or disable the UPnP™ function. Edit the UPnP Friendly Name in text field. **2**

Click the [Apply] button **3** to confirm the settings or click the [Reset] button **4** to re-enter the parameters.

SNMP Setting

Click the SNMP Setting item to display the SNMP setting Page

The screenshot shows the 'SNMP Setting' configuration page. It includes the following elements:

- 1** Enabled
- 2** SNMP V1 / V2
- 3** SNMP V3
- 4** Trap Enabled
- 5** Destination IP address: [] . [] . [] . [] (IPv4 Address)
- 6** Trap Community: public
- 7** Available Traps:
 - Cold Start
 - Warm Start
 - Authentication Failure
- 8** Apply button
- 9** Reset button

Click **1** to enable SNMP function.

Select **2** to use SNMP V1/V2 or **3** to use SNMP V3

Check the check box **4** to enable traps

Enter the Destination IP address in **5**

Enter the Trap Community used in **6**

Select the Available trap in **7**

Click the [Apply] button **8** to confirm the settings or click the [Reset] button **9** to re-enter the parameters.

RTP

Click RTP Item to configure RTP Settings

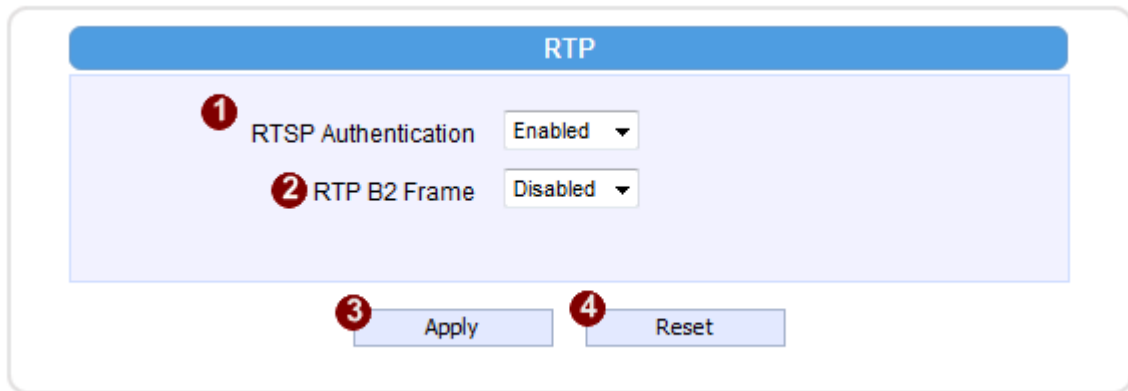

1 RTSP Authen Enable	Check box to enable RTP streaming's Account/Password authentication.
2 RTP B2 Frame Enable	Check box to enable the B2 frame in RTP streaming

Click the [Apply] button **3** to confirm the settings or click the [Reset] button **4** to re-enter the parameters.

Speed & Duplex

Click the [Speed & Duplex] item in the network section to display the "Speed and Duplex" Page. Refer to the table below for how to configure each setting.

The screenshot shows a configuration interface for 'Speed & Duplex'. At the top, there is a blue header with the text 'Speed & Duplex'. Below the header, there is a light blue box containing a dropdown menu labeled 'Network Speed' with 'Auto Detect' selected. A red circle with the number '1' is next to the dropdown. Below the dropdown, there are two buttons: 'Apply' and 'Reset'. A red circle with the number '2' is next to the 'Apply' button, and a red circle with the number '3' is next to the 'Reset' button.

Parameters	Description
1 Network speed	This item lets you select the network transmission speed. You can select from <ol style="list-style-type: none">1. Auto detect (default setting)2. 100Mbps / Full duplex3. 100Mbps / Half duplex4. 10Mbps / Full duplex5. 10Mbps / Half duplex

Click the **2** [Apply] button to confirm the settings or click the **3** [Reset] button to re-enter the parameters.

2.3.4 IP Settings

Connection Type

Click the [Connection Type] item to display the “Connection Type Page”. Refer to the table below for how to configure each setting.

Parameters	Description
1 Dynamic IP address	Click this to enable IP device’s DHCP function. It will acquire its WAN port IP address from a DHCP server within the same network. (You must have a DHCP server in order to enable this function.)
2 Static IP address	Click this to manually enter the IP address. 3 IP address: Enter the WAN port IP address. 4 Subnet mask: Enter the subnet mask of WAN port. If IP address is changed, adjust the subnet mask accordingly. 5 ISP gateway: Enter the IP address of the gateway (the router).
6 PPPoE	Click this when you connect IP device directly to the xDSL router. 7 User name: Enter the user name of your xDSL account. 8 Password: Enter the password of your xDSL account. Note: You have to click the [Save Reboot] after you click the [Apply button] to let this IP device start xDSL connections.

9 IPV6	Click the check box to support IPV6 protocol
--------	--

Click the 10 [Apply] button to confirm the settings or click the 11 [Reset] button to re-enter the parameters.

DNS

Click the [DNS] item to display the “DNS Server Settings Page”. Refer to the table below for how to configure each setting.

The screenshot shows a web interface for configuring DNS settings. At the top, there is a blue header with the text "DNS". Below the header, there are two rows of input fields. The first row is labeled "1 Primary DNS Server" and contains four input boxes, each with the number "0". The second row is labeled "2 Secondary DNS Server" and also contains four input boxes, each with the number "0". Below these input fields, there are two buttons: "3 Apply" and "4 Reset".

Parameters	Description
1 Primary DNS server	Defines the IP address of the primary DNS server. This is used for identifying this computer by name instead of IP address.
2 Secondary DNS server	The IP address of the secondary DNS server. It will be used once the primary DNS server fails.

Click the 3 [Apply] button to confirm the settings or click the 4 [Reset] button to re-enter the parameters.

DDNS

Click the [DDNS] item to display the “DDNS Server Setting Page”. Refer to the table below for how to configure each setting.

The screenshot shows the DDNS configuration interface. It includes a dropdown for status (1), a dropdown for service reference (2), and three text input fields for host name (3), user name (4), and password (5). Action buttons for 'Apply' (6) and 'Reset' (7) are located at the bottom.

Parameters	Description
1 DDNS type	Click this to enable IP device’s DDNS function. DDNS function enables user to connect to this IP device by domain name even if its IP address is not static.
2 Protocol / Service Reference	Click one of the DDNS service providers. You can visit their website to get a DDNS service account for this IP device.
3 Host name	Enter the host name of your DDNS service account. (ex: xxxx.dyndns.org)
4 User name	Enter the user name to login your DDNS service account.
5 Password	Enter the password to login your DDNS service account.

Click the **6** [Apply] button to confirm the settings or click the **7** [Reset] button to re-enter the parameters.

2.3.5 Video & Audio

Click the  [Video & Audio] item on the “Setup Page”.

Please note that some elements may not appear on all models.

Video

Click the [Video] item to display the “Video Page”. The functions here are grouped under different tabs. Starting from firmware version 4.07, there are two sets of all settings in the Video section, one for day time and one for nighttime. The camera will automatically load different profile based upon the current Day/Night status. This function allows for tailored configuration so that the camera may perform optimally under all lighting conditions.

Image (CMOS Models)

This tab concerns the general video settings. Please refer to the table below for functions.

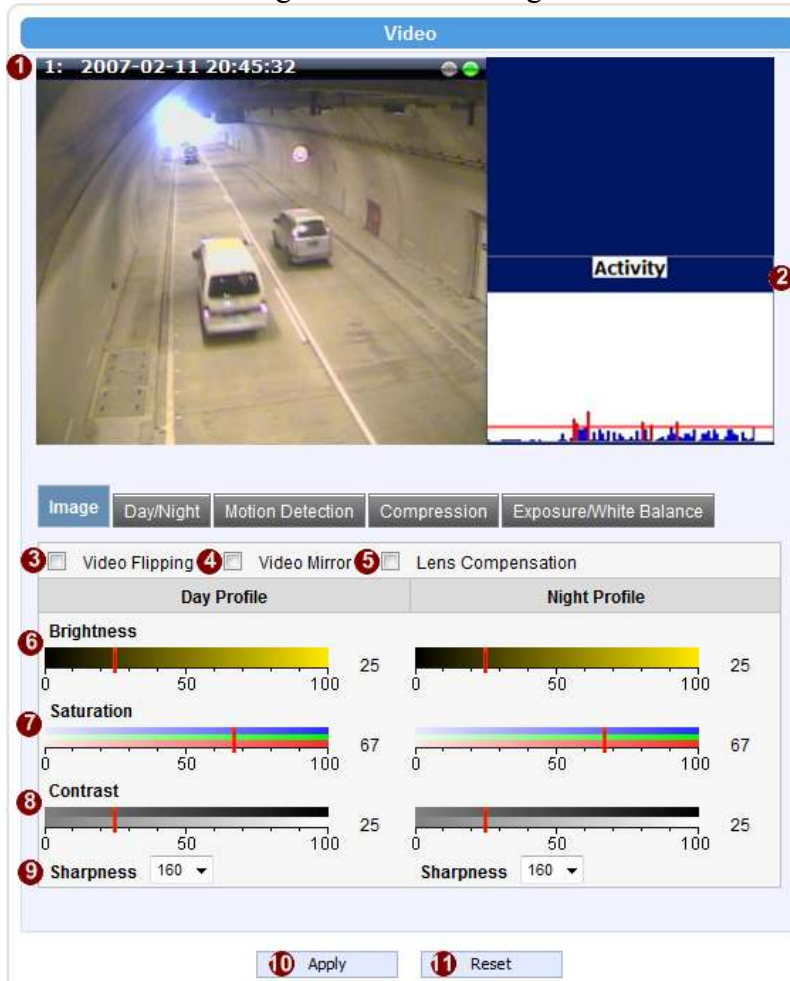

The screenshot displays the 'Video' configuration page. At the top, a blue header bar contains the word 'Video'. Below this, a live video feed shows a tunnel with two cars. A timestamp '1: 2007-02-11 20:45:32' is visible in the top left of the video. To the right of the video is an 'Activity' histogram. Below the video and histogram are five tabs: 'Image', 'Day/Night', 'Motion Detection', 'Compression', and 'Exposure/White Balance'. The 'Image' tab is selected. Underneath, there are three checkboxes: 'Video Flipping', 'Video Mirror', and 'Lens Compensation'. Below these are two columns of sliders for 'Day Profile' and 'Night Profile'. The 'Day Profile' sliders are: Brightness (set to 25), Saturation (set to 67), Contrast (set to 25), and Sharpness (set to 160). The 'Night Profile' sliders are: Brightness (set to 25), Saturation (set to 67), Contrast (set to 25), and Sharpness (set to 160). At the bottom, there are 'Apply' and 'Reset' buttons.

Parameters	Description
1 Live View	Live view of the camera
2 Activity	Motion activity status
3 Video Flipping	Check this box to flip the video up-down
4 Video Mirror	Check this box to mirror the video left-right
5 Lens Compensation	Check this box to use best pre-set settings for bundled lens
6 Brightness (Day Profile)	Select the brightness value
7 Saturation (Day Profile)	Select the saturation value
8 Contrast (Day Profile)	Select the contrast value
9 Brightness (Night Profile)	Select the brightness value
10 Saturation (Night Profile)	Select the saturation value
11 Contrast (Night Profile)	Select the contrast value
12 Sharpness (Day Profile)	Select the sharpness value
13 Sharpness (Night Profile)	Select the sharpness value

Click the **14** [Apply] button to confirm the settings or click the **15** [Reset] button to re-enter the parameters.

Image (CCD Models)

This tab concerns the general video settings. Please refer to the table below for functions.

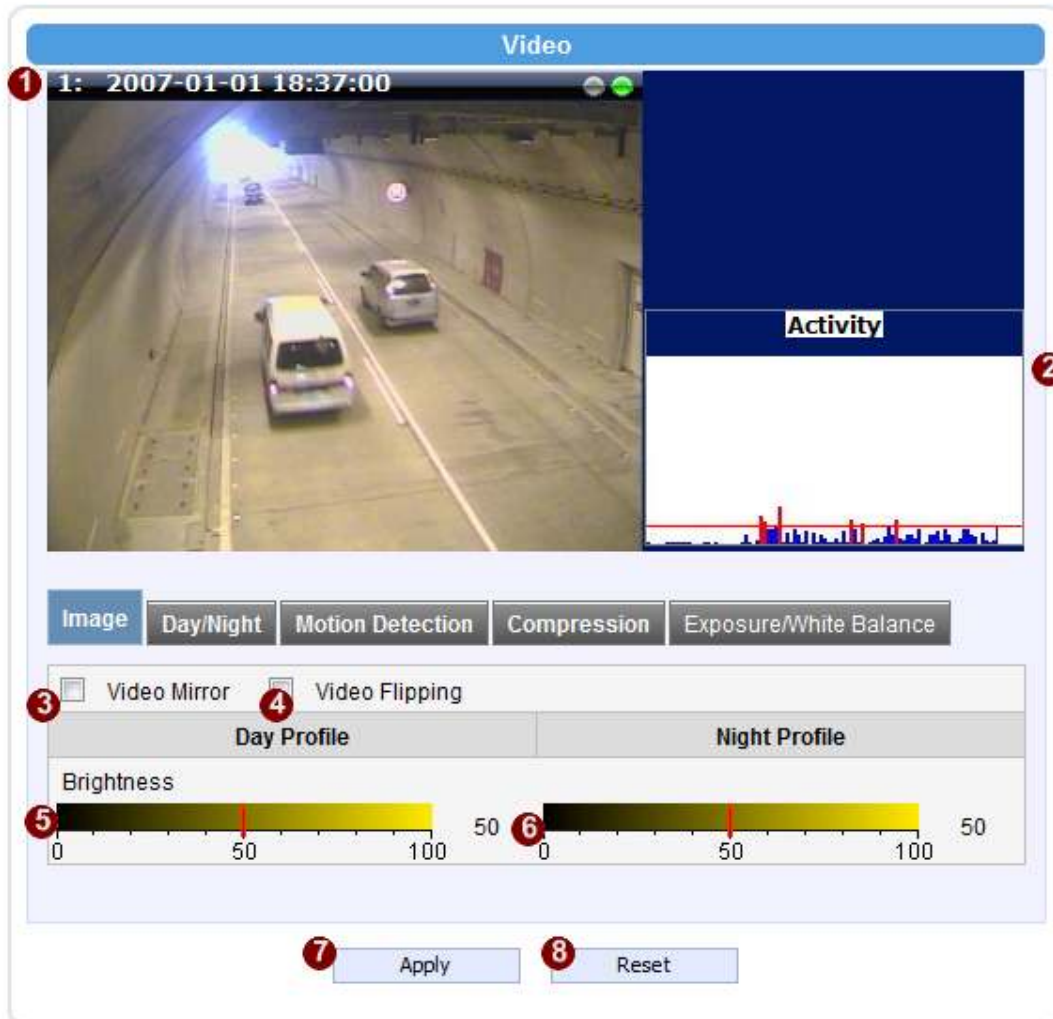

Parameters	Description
1 Live View	Live view of the camera
2 Activity	Motion activity status
3 Video Flipping	Check this box to flip the video up-down
4 Video Mirror	Check this box to mirror the video left-right
5 Brightness (Day Profile)	Select the daytime brightness value
6 Brightness (Night Profile)	Select the nighttime brightness value

Click the **7** [Apply] button to confirm the settings or click the **8** [Reset] button to re-enter the parameters.

Day/Night (CMOS Non-D/N Models)

The screenshot shows a camera web interface with a blue header labeled 'Video'. Below the header is a video feed of a hallway with a person walking. To the right of the video is an 'Activity' log. Below the video and activity log are several tabs: 'Image', 'Day/Night', 'Motion Detection', 'Compression', and 'Exposure/White Balance'. The 'Day/Night' tab is selected and contains the following controls:

- A 'Blue' label followed by the text 'Switch from Day mode to Night mode' and a dropdown menu set to '74' (marked with a red circle 1).
- The text 'Switch if lasts more than' followed by a text input field containing '10' and the word 'Seconds' (marked with a red circle 2).
- A horizontal bar representing a brightness meter, with a sun icon on the left (marked with a red circle 3) and a moon icon on the right. A blue vertical line indicates the current level.
- A 'Green' label followed by the text 'Current Exposure Level' and a text input field containing '0' (marked with a red circle 4), and a 'Get' button.
- At the bottom of the interface are two buttons: 'Apply' (marked with a red circle 5) and 'Reset' (marked with a red circle 6).

This tab concerns the day and night switch timing for your camera. Please refer to the table below.

Parameters	Description
1 Switch from Day mode to Night mode	This value controls the level of light where camera switches into night mode. Increasing it will make camera switch to night mode at a darker illumination level.
2 Switch if lasts more than X seconds	The camera will only switch day/night status if the illumination level stays either above or below the boundary for this much time. This is to prevent a temporary brightness change from triggering unnecessary day/night changes.
3 Brightness Meter	This bar shows the illumination level at which cameras go

Bar	to night or day mode (Blue bars), and shows the current detected illumination level (Green bars). Use this bar to fine tune the day/Night switch timing.
4 Get Current Exposure Level	Clicking this button will refresh the illumination level reading from the camera sensor. The larger the number, the darker the environment.

Click the **5** [Apply] button to confirm the settings or click the **6** [Reset] button to re-enter the parameters.

The screenshot shows a video control interface with the following components:

- Video Feed:** Shows a hallway with a person walking. A timestamp reads "1: 2007-02-11 20:46:31".
- Activity Panel:** A blue header labeled "Activity" above a white area.
- Settings Menu:**
 - Image** (selected), Day/Night, Motion Detection, Compression, Exposure/White Balance.
 - Day/Night Mode:** Set to "AUTO" (1).
 - Day/Night Type:** Set to "CDS" (2).
 - Blue:** "Switch from Day mode to Night mode" set to 89 (3). "Switch if lasts more than" set to 10 Seconds (4).
 - Red:** "Switch from Night mode to Day mode" set to 77 (5). "Switch if lasts more than" set to 10 Seconds (6).
 - Day/Night IR Led:** Set to "AUTO" (7).
 - Visual Bar (8):** A horizontal bar with a sun icon on the left and a moon icon on the right, with green, red, and blue vertical markers.
 - Green:** "Current Exposure Level" set to 72, with a "Get" button (9).
- Buttons:** "Apply" (10) and "Reset" (11) buttons at the bottom.

Parameters	Description
1 Day/Night Mode	Select the day/night mode. Auto: The camera would switch between day and night mode automatically. It will follow Day to Night and Night to Day threshold defined by user below. Day: The camera will stay in day (Color) mode. Night: The camera will stay in night (black & white) mode.
2 Day/Night Type	Select the method used by Camera to determine illumination level. It can be either CDS light sensor or through image analysis by DSP. Not every model will allow selection for this.
3 Switch from Day mode to Night mode	Check box to enable the B2 frame in RTP streaming
4 Switch if lasts more than X seconds	The camera will only switch day/night status if the illumination level stays either above or below the boundary for this much time. This is to prevent a temporary brightness change from triggering unnecessary day/night changes.
5 Switch from Night mode into Day Mode	This value controls the level of light where camera switches into Day mode. Increasing it will make camera switch to night mode at a darker illumination level.
6 Switch if lasts more than X seconds	The camera will only switch day/night status if the illumination level stays either above or below the boundary for this much time. This is to prevent a temporary brightness change from triggering unnecessary day/night changes.
7 Day/Night IR LED	IR LED may be configured as AUTO or Disabled here. If it is set as AUTO, LED will turn on in night mode and turn off in day mode. If set to Disabled, LED will stay off when camera switches into night mode.
8 Brightness Meter Bar	This bar shows the illumination level at which cameras go to night or day mode (Blue / Red bars), and shows the current detected illumination level (Green bars). Use this bar to fine tune the day/Night switch timing.
9 Get Current Exposure Level	Clicking this button will refresh the illumination level reading from the camera sensor. The larger the number, the darker the environment.

Click the 10 [Apply] button to confirm the settings or click the [Reset] button to re-enter the parameters.

Day/Night (CCD D/N Models)



This tab concerns the day and night switch timing for your camera. Please refer to the table below.

Parameters	Description
1 Day/Night Mode	Select the day/night mode. Auto: The camera would switch between day and night mode automatically. It will follow Day to Night and Night to Day threshold defined by user below. Day: The camera will stay in day (Color) mode. Night: The camera will stay in night (black & white) mode.
2 Switch from Day	This value controls the level of light where camera

	mode to Night mode	switches into night mode. Increasing it will make camera switch to night mode at a darker illumination level.
3	Switch from Night mode into Day Mode	This value controls the level of light where camera switches into Day mode. Increasing it will make camera switch to night mode at a darker illumination level.
4	Brightness Meter Bar	This bar shows the illumination level at which cameras go to night or day mode (Blue / Red bars), and shows the current detected illumination level (Green bars). Use this bar to fine tune the day/Night switch timing.
5	Get Current Exposure Level	Clicking this button will refresh the illumination level reading from the camera sensor. The larger the number, the darker the environment.

Click the **6** [Apply] button to confirm the settings or click the **7** [Reset] button to re-enter the parameters.

How it works

An important feature in this screen is that user may now customize the illumination level to perform day/night mode switches.

On the horizontal brightness meter shown here, there are three colored bars. The bar represents light amplifying levels 0 to 100, where 0 is Brightest and 100 is darkest. 0 means no digital amplification of incoming light signals, which means that the environment is bright enough for the camera to get good quality images.

When the environment gets darker, as when the sun is setting over the horizon, the environmental gets darker. To maintain proper image brightness level, the camera will attempt to digitally amplify the light signals received by the sensor. The Blue one is the level at which camera will go into night mode, and remove Mechanical IR cut filter and open IR LED if available. The red one indicates the illumination level at which the camera will consider bright enough to go back to day (Color) mode.

The Red bar should always be to the left of the blue bar. As camera go from day to night mode, more lights are allowed inside (the IR filter is removed), so the detected light signal level will increase. If the night-to-day illumination level is too close to the day-to-night level, the camera will immediately consider it bright enough to go back to day mode, which will result in continuous day/night switching.

Motion Detection

1: 2007-02-11 20:32:16

Adjust Column

Adjust Square

Activity

Image Day/Night **Motion Detection** Compression Exposure/White Balance

[-] Motion Detection (Only for Media 1)

3 Motion Enable

Region	Motion Enable	Sensitivity [0-100]	Trigger Interval [1-300 Secs]	Trigger Threshold [0-100%]
1	4 <input checked="" type="checkbox"/>	70	1	10
2	<input checked="" type="checkbox"/>	70	1	10
3	<input checked="" type="checkbox"/>	70	1	10

PIR Motion Sensor Enable

Enable	Sensitivity [0-100]	Trigger Interval [1-300 Secs]
8 <input checked="" type="checkbox"/>	80	1

9 Apply 10 Reset

Click the 9 [Apply] button to confirm the settings or click the 10 [Reset] button to re-enter the parameters.

Video Motion Detection:

STEP1: Click the Plus sign 3 to expand the Motion Detection settings then Click the Motion Enable checkbox to enable motion detection.

STEP2: Click the **4** checkbox to enable motion detection for each individual region.

STEP3: Click one region to start to edit its size and location. You can click the “Adjust Column” to drag motion region to your desired location. You can click the “Adjust Square” and drag to adjust motion region size. You can click the upper right button to cancel this motion region. Repeat above procedure to adjust the motion region.

STEP4: Set the **5** sensitivity of motion detection region.

STEP5: Set the **6** interval time of motion detection. After a motion event is triggered, no more events will be triggered within this time in the same region

STEP6: Set the **7** trigger threshold of motion detection region. The larger this value, the larger the object size needed to trigger motion detection.

STEP7: In motion activity **2** window, the bar shows the motion activity status. You can also see the trigger threshold (Red line). When the motion activity exceeds the trigger threshold, the bar would become red to indicate that a motion event has been triggered.

While viewing the motion activity window, you can adjust the motion sensitivity (the higher, the easier camera considers video change to be an activity) and the threshold (the higher, the larger the activity needed to trigger a motion event). If the default settings are not satisfactory for your scene, you may try our alternative recommendations of:

Sensitivity: 80, Threshold: 2~5 (for normal environment)

Sensitivity: 80, Threshold: 5~10 (for very noisy environment)

PIR (Passive Infra Red motion sensors) (Not available to all models)

PIR sensors are available for some models. For the models with PIR, there will be a PIR Motion Sensor section below the video motion detection.

You may enable PIR sensors by the checkbox **8** and modify the sensitivity/ trigger interval.

When motion is detected via PIR sensor, a red border will show around the whole view area.

Please note that PIR sensors have a shorter range of detection than Video motion detection.

Compression

The screenshot displays a web-based configuration interface for a video camera. At the top, a blue header bar contains the word "Video". Below the header, a video feed window shows a tunnel with a truck. The timestamp "1: 2007-01-01 00:16:45" is visible in the top left of the video feed. To the right of the video feed is a dark blue panel with the word "Activity" in white text. Below the video feed, there are five tabs: "Image", "Day/Night", "Motion Detection", "Compression" (which is selected and highlighted in blue), and "Exposure/White Balance".

Under the "Compression" tab, there are two sections for stream configuration:

- Stream 1** (expanded):
 - Encoder Type: H264 (1)
 - Resolution: 1280x720 (2)
 - Day Profile:
 - Frame Rate: 30 (3)
 - Video Bit Rate Mode: Variable Bit Rate (4)
 - Quality: High (5)
 - GOP 1 I-frame /: Second (6)
 - Night Profile:
 - Frame Rate: 15 (7)
 - Video Bit Rate Mode: Constant Bit Rate (8)
 - Video Max Bit Rate: UNLIMITED (9)
 - Video Bit Rate: 1.5M (10)
- Stream 2** (checked as Enabled):
 - Encoder Type: MJPEG
 - Resolution: 640x480
 - Day Profile:
 - Frame Rate: 15 (11)
 - Quality: 60 (12)
 - Night Profile:
 - Frame Rate: 7
 - Quality: 50

At the bottom of the configuration area, there are two buttons: "Apply" (13) and "Reset" (14).

There are two streams output available for this network device. Click the [Stream 1] or

[Stream 2] item to display the content page, Contents for both stream are identical. Refer to the table below for how to configure each setting.

Parameters	Description
① Encoder Type	Select the encoder's compression type. MPEG-4 / MJPEG / H.264
② Resolution	Select the video resolution of the IP device.
③ Frame rate	Select the available frame rate from the drop down menu.
④ Video Bit Rate Mode	Select the video bit rate mode. Constant Bit Rate: The bit rate remains constant at all conditions. Variable Bit Rate: The video bit rate will vary based upon scene complexity and amount of movement. The quality will remain the same.
⑤ Quality	When encoder type is MPEG4 or H.264, and video bitrate mode is "Variable Bit Rate" Select the quality value from High / Medium / Low
⑥ GOP Length	When encoder type is MPEG4 or H.264. and video bitrate mode is "Variable Bit Rate". Select the Interval between two I-frames. This is also called GOP Length. (Group of Picture) . Default value is one I frame per second. The maximum length of GOP is limited to 60.
⑦ Frame rate	Select the available frame rate from the drop down menu. This puts a hard cap on the maximum bit rate allowed in any given second of video streaming. Assigning a limited bit rate may result in a few dropped frames rate when the stream data overflows the allowed bit rate. Doing so will also disable Bit Rate setting below.
⑧ Video Bit Rate Mode	Select the video bit rate mode. Constant Bit Rate: The video bit rate remains constant at all conditions. Variable Bit Rate: The video bit rate will vary based upon scene complexity and amount of movement. The quality will remain the same.
⑨ Video Max Bitrate	This puts a hard cap on the maximum bit rate allowed in any given second of video streaming. Assigning a limited bit rate may result in a few dropped frames rate when the stream data overflows the allowed bit rate. Doing so will also disable Bit Rate setting below.
⑩ Video Bitrate	This is the target bitrate that the camera will attempt to provide when using Constant Bitrate mode. The actual value will fluctuate slightly based on scene changes.
⑪ Frame rate	Select the frame rate for each profile by choosing from the drop

(Stream2)	down list. Frame rates available for stream 2 may be less than stream 1, depending upon the setting.
12 Quality	When encoder type is MJPEG: Select the quality value of MJPEG encoder type from 1 to 100.

Click the **13** [Apply] button to confirm the settings or click the **14** [Reset] button to re-enter the parameters.

Exposure / White balance

1	Line Frequency	Change settings between 60Hz or 50Hz, depending on the AC power type of your region..
2	WDR Mode	This determines if the WDR processing is turned on or off. Turn this on only when you have very large brightness differences in a single scene. Otherwise leave it off.
3	WDR Level	The strength of image modification by WDR algorithm. Increasing this will increase the effect of WDR processor.

4	Exposure Mode	<p>Select exposure mode to auto or manual.</p> <ol style="list-style-type: none"> 1. Auto: The IP camera will adjust the exposure automatically. 2. Manual: Manually select the 8 Exposure Gain and 9 Shutter Speed below. Day and night mode change will not operate as normal under manual Exposure.
5	White Balance	<p>Select the white balance mode. After you set the parameter, you need to wait for 5~10seconds to see the final result.</p> <ol style="list-style-type: none"> 1. AUTO : Auto white balance (default) 2. INDOOR1: Select the indoor white balance profile 1. 3. INDOOR2: Select the indoor white balance profile 2. 4. OUTDOOR1: Select the outdoor white balance profile 1. 5. OUTDOOR2: Select the outdoor white balance profile 2 6. HOLD: Select this to let the IP camera automatically obtain a best white balance setting according to current environment. The IP camera will use this setting to adjust color. NOTE: This setting will be lost after you reboot the camera. 7. MANUAL: Select this to enable manual setting of the white balance. You will need to enter the 6 R Gain and 7 B Gain setting below.
6	R Gain (Manual White balance mode only)	Add or decrease redness to the video when under Manual White Balance mode. (This function is only available in Manual White balance mode.)
7	B Gain (Manual White balance mode only)	Add or decrease blueness to the video when under Manual White Balance mode. (This function is only available in Manual White balance mode.)
8	Exposure Gain (In Manual Exposure Mode only)	Select the exposure Gain of the IP camera. The higher the value = brighter images. (1 ~ 255)
9	Shutter Speed (In manually shutter mode only)	Increase or decrease the shutter speed. The closer the number is to 1, the better nighttime performance is, although this also causes motion blur to the video.

10	Exposure Mode	<p>Select exposure mode to auto or manual.</p> <ol style="list-style-type: none"> 1. Auto: The IP camera will adjust the exposure automatically. <p>Manual: Manually select the 8 Exposure Gain and 9 Shutter Speed below..</p>
11	White Balance (In Indoor/Outdoor/Auto/Hold profiles only)	<p>Select the white balance mode. After you set the parameter, you need to wait for 5~10seconds to see the final result.</p> <ol style="list-style-type: none"> 1. AUTO : Auto white balance (default) 2. INDOOR1: Select the indoor white balance profile 1. 3. INDOOR2: Select the indoor white balance profile 2. 4. OUTDOOR1: Select the outdoor white balance profile 1. 5. OUTDOOR2: Select the outdoor white balance profile 2 6. HOLD: Select this to let the IP camera automatically obtain a best white balance setting according to current environment. The IP camera will use this setting to adjust color. NOTE: This setting will be lost after you reboot the camera. <p>For all the settings above, you will need to setup the value for 12 AE Reference Target and Maximum auto shutter speed.</p> <ol style="list-style-type: none"> 7. MANUAL: Select this to enable manual setting of the white balance. You will need to enter the 6 R Gain and 7 B Gain setting below.
12	AE Reference Target	<p>This is the desired image brightness output level. The camera will attempt to change the exposure levels or digital amplification levels to achieve this level of brightness. Increasing this may provide a brighter image, but if there are extremely dark areas, this may also create slightly more noise in the underexposed areas.</p>
13	Maximum auto shutter speed	<p>The maximum allowed time for the camera to take a single image.</p>

Click the 14 [Apply] button to confirm the settings or click the 15 [Reset] button to re-enter the parameters.

Audio

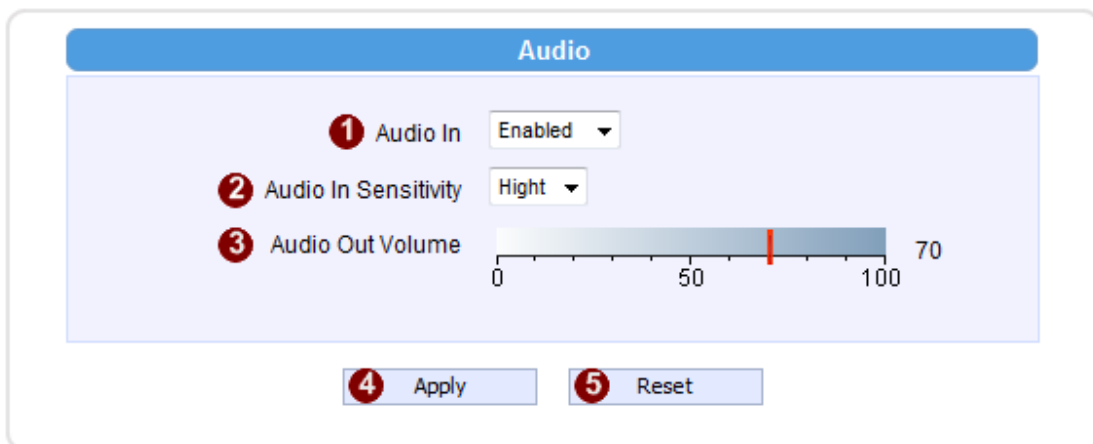

1	Audio In	Select to enable or disable the audio in function.
2	Audio In sensitivity	Select the sensitivity of audio microphone.
3	Audio Out Volume	Adjust the Audio Out volume.

Click the **4** [Apply] button to confirm the settings or click the **5** [Reset] button to re-enter the parameters.

OSD/Privacy Mask

OSD (On Screen Display) and Privacy masks are configured in this section. There are four regions available. Each may be used either as a Privacy mask or an OSD text.

The screenshot displays the 'OSD/Privacy Mask' configuration interface. At the top, a preview window shows a video feed with a black privacy mask and a red OSD text box. The text in the OSD box reads '1: 2010-04-28 11:45:20'. Below the preview, there are four configuration sections for different regions:

- Region 1:** Enable Type: Privacy Mask. Color: Black. Setup: .
- Region 2:** Enable Type: Privacy Mask.
- Region 3:** Enable Type: OSD. Color: Red. Transparent: 100. Position: Top. String: USER DEFINED. Format: %U%YYYY%MM%DD%N. < Format Notice >
- Region 4:** Enable Type: OSD.

At the bottom of the window are two buttons: 'Apply' and 'Reset'.

Parameters	Description
① Enable	Check this box to enable each OSD / Privacy mask region
② OSD / Privacy mask	Each region can be in one of two types. OSD (On Screen Display) or Privacy mask
③ Color (Privacy mask)	This determines the color of the Privacy Mask Area. You may choose between Black, Green, Red and Blue.
④ Setup	Click this checkbox to enable Privacy mask area setup. Click and drag the adjust square at the lower right to change dimensions, click and drag the adjust column at the top to move. (Similar to Motion Detection Region)
⑤ Color(OSD)	This determines the color of the OSD Text. You may choose between Black, Green, Red and Blue.
⑥ Transparent	This number determines the level of transparency for this OSD Text. 1 means that the background between the texts will not be visible, while 100 means the background will show through the OSD text.
⑦ Position	Select the location where the text will appear in the image.
⑧ String	This is where you enter the user defined string (%U) as described in the next section
⑨ Format	This controls what is shown in the OSD text. You can click the Format Notice to the corner for a full list of available parameters. The OSD text is primarily based upon this field.
⑩ Format Notice	Click here to see the syntax list of how to configure the OSD text.

Click the ⑪ [Apply] button to confirm the settings or click the ⑫ [Reset] button to re-enter the parameters.

2.3.6 System

Click the  [System] item on the “Setup Page”.



User Account

Click the [User Account Setting] item to display the “User Account Setting Page”.

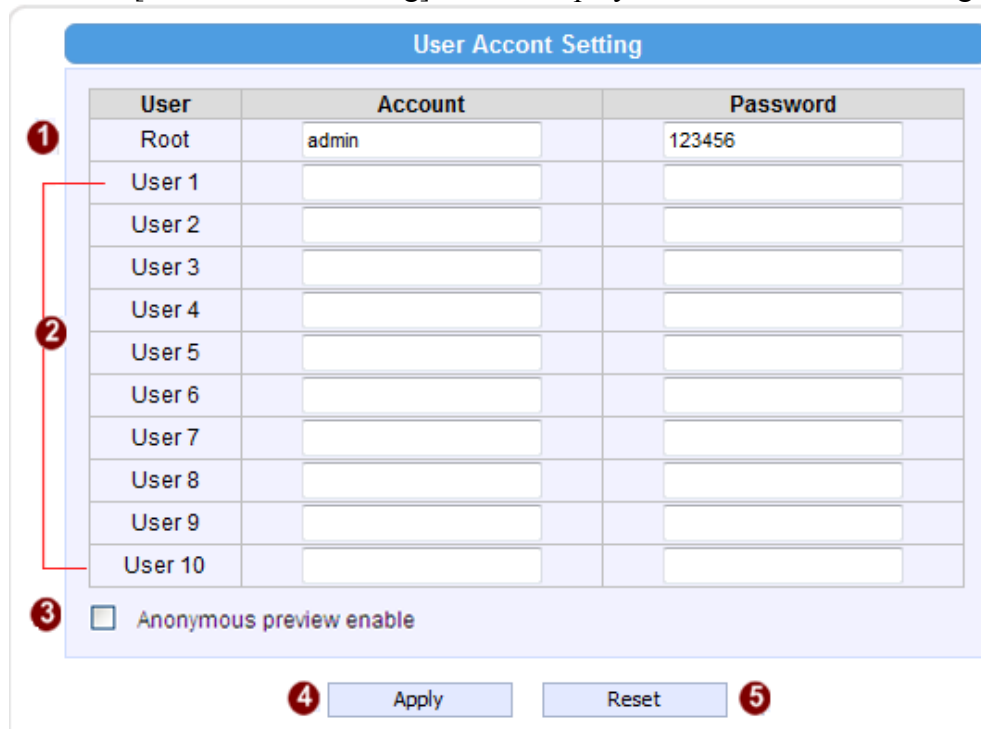

A screenshot of the 'User Account Setting' page. The page has a blue header with the title 'User Account Setting'. Below the header is a table with three columns: 'User', 'Account', and 'Password'. The table contains 11 rows: 'Root' with 'admin' and '123456', and 'User 1' through 'User 10' with empty input fields. To the left of the table, there are red circles with numbers 1, 2, and 3. A red bracket connects circles 1 and 2 to the first and second rows of the table. Below the table is a checkbox labeled 'Anonymous preview enable' with a red circle and number 3 next to it. At the bottom of the page, there are two buttons: 'Apply' and 'Reset', with red circles and numbers 4 and 5 next to them respectively.

User	Account	Password
Root	admin	123456
User 1		
User 2		
User 3		
User 4		
User 5		
User 6		
User 7		
User 8		
User 9		
User 10		

Anonymous preview enable

Apply Reset

Setup the account names and their respective passwords. There are 1 root (administrator) **1** account and 10 common user accounts **2**. Administrator account allows the user to watch the live view and setup everything; but common user account allows user only to watch the live image.

Click the check box **3** to enable “Anonymous preview”. When it is enabled, user can

login this camera to view video without input account and password. But user will be required to input account and password if they want to change any setting

Click the **4** [Apply] button to confirm the settings or click the **5** [Reset] button to re-enter the parameters.

System Info

Click the [System Info] item to display the “System Information Page”. This shows details about this IP device including system information, WAN status and system log. Refer to the table below for how to configure each setting.

View the information at the 3 textboxes. This information is very useful to understand the IP device status and to resolve any problem that might occur.

The screenshot displays the 'System Information' page with three main sections, each marked with a red circle and a number:

- 1 System Information:**
 - Firmware Version = A1D-310-V4.07.10
 - MAC Address = 00:0F:7C:56:56:56
 - Production ID =
 - Factory Default Type = Two Ways Audio (0x71)
 - Company Name =
 - Web Site =
 - Profile ID =
 - Sensor Board = MT9M131
- 2 WAN Status:**
 - IP Address : 10.0.3.69
 - Netmask : 255.255.240.0
 - Gateway : 10.0.0.254
 - DNS Server : 0.0.0.0 0.0.0.0
 - DDNS Host :
 - WAN Connect Status : Disconnect
 - DNS Connect Status : Disconnect
 - DDNS Connect Status : Disconnect
- 3 System Log:**
 - BootLoader Version BOOTLOADER-310-V01.12
 - Starting Modules Manager
 - Devcap Version 0x0002
 - Start loading Profile File ...
 - Initiating factory button ...
 - Starting loading SYS File...
 - Starting Streaming Core ...
 - Starting DNS Manager

At the bottom, there is a 'Config file:' section with three buttons:

- Parameter List
- Server Report
- Show Licenses

Column	Description
① System info	It shows the firmware version, MAC address, production ID, and factory default type of IP device.
② WAN status	It shows the WAN port's IP address, netmask, gateway, DNS server, DDNS host and connection status.
③ System log	It shows the system event. This column is very useful to as a diagnostic tool.

Click ④ [Parameter List] where you may see all configurations of the IP device.

Click ⑤ [Server Report] to export related information of the IP device while reporting a support to your support channel.

Factory Default

Click the [Factory Default] item to display the “Factory Default Page”.

The screenshot shows a web interface titled "Factory Default". It contains two radio button options:

- ① Preserve WAN port and HTTP/HTTPS port numbers setting.
- ② Reset parameters to the original factory settings.

At the bottom, there are two buttons: ③ Apply and ④ Reset.

If you want to keep network settings and restore other settings to factory default, please click radio box ① . If you click ② instead , all the settings would be lost. You will have to use factory default IP setting to connect to this camera. Please refer to previous login section.

If you want to reset all setting to default, click to select this radio box ② .

Click the [Apply] button to show a warning dialog that reminds you again before restoring the device to factory default.

Firmware Upload

Click the [Firmware Upload] item to display the “Firmware Upgrade Page”. Upgrade the IP device’s firmware through this page with the following instructions.

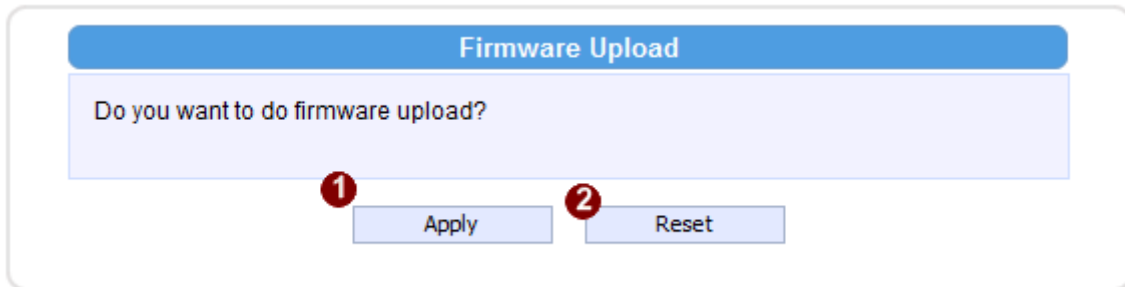

Click **1** [Apply] button. The “Firmware Upgrade Page-2” will be displayed as below.

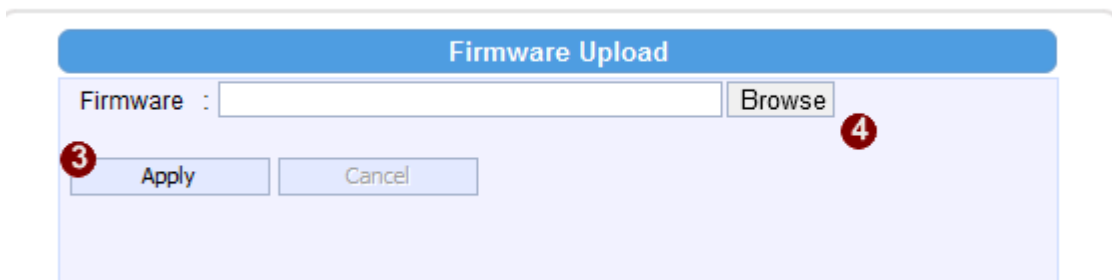

Click the **4** [Browse] to select the upgrade image file and click the [enter]. You can always get the latest version at our website.

Click the **3** [Apply] button to start upgrading

The upgrade process window will show a progress bar indicating upgrade status. You can click the **5** [Cancel] button to stop the firmware upgrade.

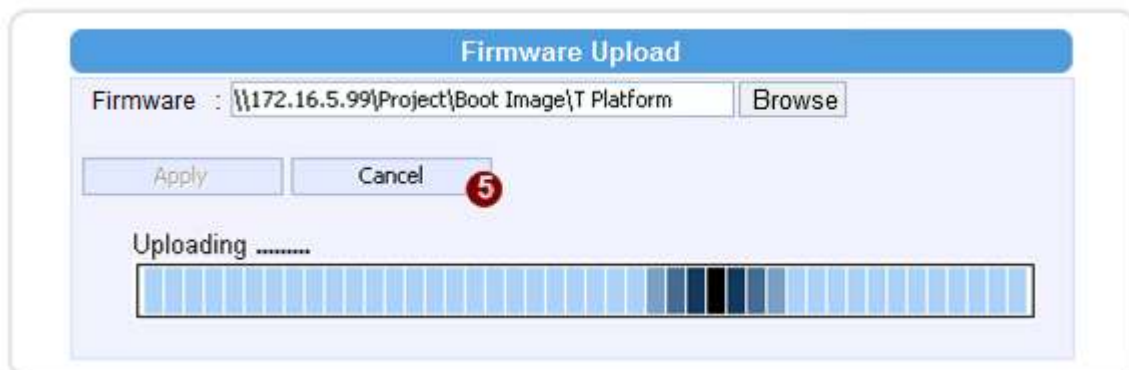

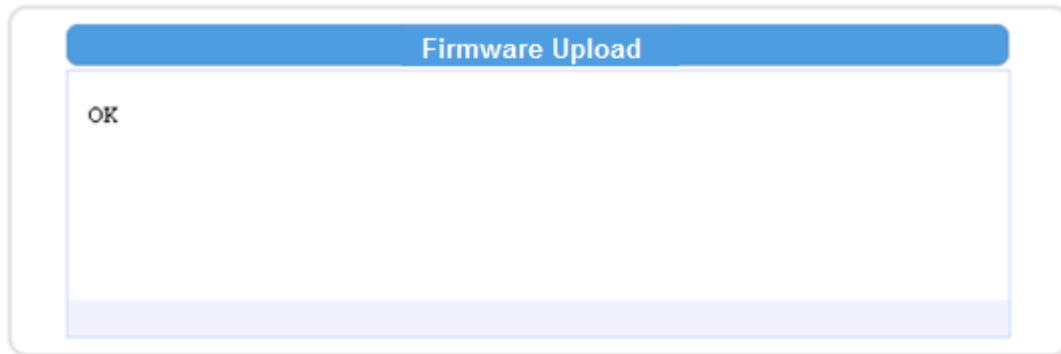

Once the process is finished, the progress bar will show the upgrading as OK, and reboot the IP device system.

NOTE: If you cancel the firmware upgrade during upgrade process, the browser window will be closed

Profile Upload

Profiles are sets of parameters that control how the image sensor behaves. Sometimes profiles are fine-tuned again to suit a specific environment, or for generally better image. They are not updated as frequently as firmware, and a good profile can stay in use for a very long time. Occasionally, you may wish to load a new profile pack into your camera. This section tells you how to upgrade IP Camera's Profile Pack.

Click the [Profile Upload] item to display the "Profile Upload Page".

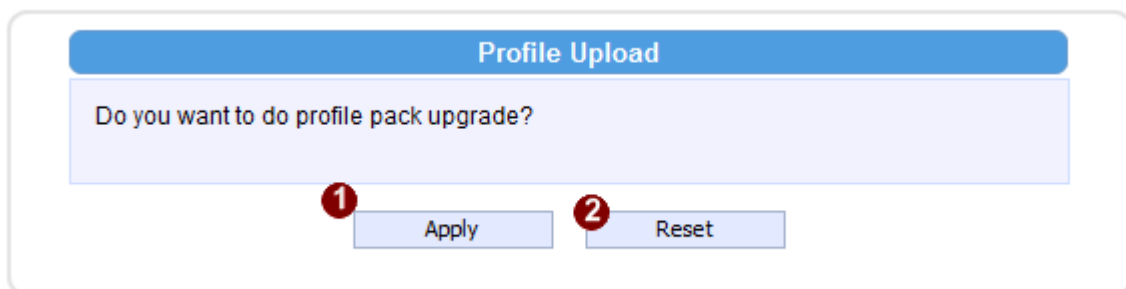

STEP1: Click **1** [Apply] button. The "Profile Pack Page-2" will be displayed as below.

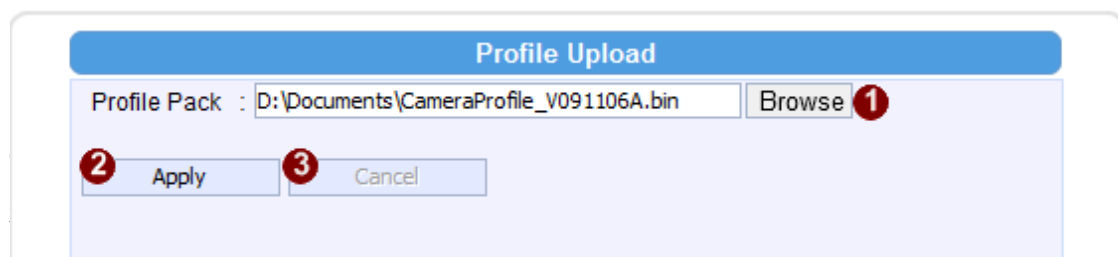

STEP3: Click the **2** [Apply] button to start upgrading

STEP5: The upgrade process window shows a progress bar indicating upgrade status.

STEP6: The system will reboot after profile upload.

Save & Reboot

This section tells you how to save all the settings and reboot this IP device. This is critical because some settings might not take effect before save and reboot. Click the [Save & Reboot] item to display the “Reboot Page”.

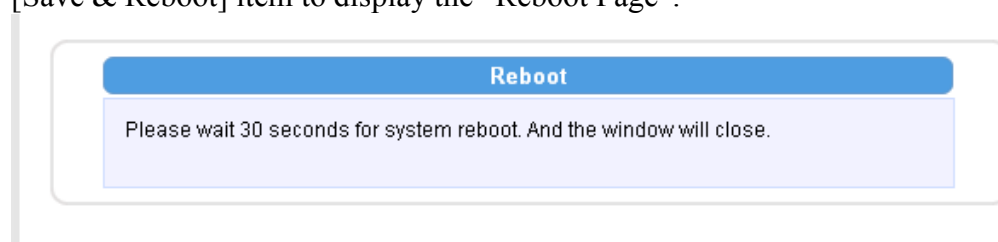

The Action LED indicator will go dark to indicate that the IP device is rebooting. After around 30 seconds, the Action LED will light up again to indicate that the reboot is completed.

Logout

Clicking this item allows you to log out of the IP device. Be sure to logout this IP device once your setting is completed.

3

APPENDIX

3.1 Specification

3.1.1 SIPMPH Camera Series

*** Network Spec.**

Video Compression	
Compression	H.264 Baseline / MPEG-4 SP / M-JPEG
Resolution	SXGA (1280x1024) at 18 fps HD720 (1280x720) at 26fps VGA (640x480) at 30 fps
Image Frame Rate	Up to 18 fps at SXGA resolution; Up to 26 fps at HD720 resolution; Up to 30 fps at VGA resolution
Audio Input	
Compression	8kHz, Mono, PCM
Audio Line Input	Unbalanced, 1.4 Vp-p 1Vrms, terminal Block
Audio Output	
Compression	8kHz, Mono, PCM
Audio Line Output	Unbalanced, 1.4 Vp-p 1Vrms, terminal Block
External I/O	
Reset Button	Factory default
Alarm(SIPMPT Only)	
Digital Input	1, terminal bloc
Transistor Output	1, terminal block
Network	
Ethernet	Ethernet(10/100 Base-T),RJ-45 connector
Protocol	TCP, UDP ,IP, HTTP, DHCP, PPPoE, RTP, RTSP, FTP, SMTP, DNS, DDNS, NTP, ICMP, IGMP, ARP, #GPP
Software	
Web Browser	MS Internet Explorer 6.0 or above
Security	Password protection: configured by the administrator
Compatibility	Most major 3 rd party software suites
NVR Software	Included at no additional charge

*** Camera Spec.**

SIPMPBVFH

Image Sensor	1/3" Micron Progressive Scan CCD
Effective Pixels	1280 x 1024
Electric Shutter	1/10 ~ 1/2,000sec (60Hz) 1/10 ~ 1/2,000sec (50Hz)
Lens	Varifocal Lens f=3.3~12mm
Min. scene Illumination	0.5 Lux at F1.0 (2400K, 30IRE)
Synchronization	Internal
S/N Ratio	Better than 44 dB
Flickerless	1/120 sec(60Hz), 1/100 sec(50Hz)
Day/Night	Mechanical IR Cut Filter
White Balance	6Mode(AUTO,INDOOR1/2,OUTDOOR1/2,HOLD CURRENT,MANUAL) Configurable
AGC	Automatic (User defened)
BLC	YES
Motion Detection	Yes (3 Windows)
Power Source	DC12V (300mA)
	PoE (IEEE802.3af) with Class 3
Operational Temperature	-29℃ ~ +50℃ (- 20°F ~122°F)
Operational Humidity	30% ~90% RH
Dimensions(WxHxD)	92 x 85 x 264 mm
Weight	1.3kg

SIPMPDVFH

Image Sensor	1/3" Micron Progressive Scan CCD
Effective Pixels	1280 x 1024
Electric Shutter	1/10 ~ 1/2,000sec (60Hz) 1/10 ~ 1/2,000sec (50Hz)
Lens	Varifocal Lens f=3.3~12mm
Min. scene Illumination	0.5 Lux at F1.0 (2400K, 30IRE)
Synchronization	Internal
S/N Ratio	Better than 44 dB
Flickerless	1/120 sec(60Hz), 1/100 sec(50Hz)
Day/Night	Mechanical IR Cut Filter
White Balance	6Mode(AUTO,INDOOR1/2,OUTDOOR1/2,HOLD CURRENT,MANUAL) Configurable
AGC	Automatic (User defened)
BLC	YES
Motion Detection	Yes (3 Windows)
Power Source	DC12V (300mA)
	PoE (IEEE802.3af) with Class 3
Operational Temperature	-29℃ ~ +50℃ (- 20°F ~122°F)
Operational Humidity	30% ~90% RH
Dimensions(HxD)	132 ø x 120.85 mm
Weight	1.4kg



**200 New Highway
Amityville, NY 11701
631-957-8700
www.specotech.com**

Rev.100518

Speco Technologies is constantly developing product improvements.
We reserve the right to modify product design and specifications without notice
and without incurring any obligation.