

SSA-P400  
SSA-P400T  
SSA-P401  
SSA-P401T

# Access Control Panel



## user manual

imagine the possibilities

Thank you for purchasing this Samsung product.  
To receive more complete service,  
please visit our website.  
[www.samsungsecurity.com](http://www.samsungsecurity.com)

**SAMSUNG**

# safety information

	<b>CAUTION</b> RISK OF ELECTRIC SHOCK. DO NOT OPEN	
<b>CAUTION:</b> TO REDUCE THE RISK OF ELECTRIC SHOCK, DO NOT REMOVE COVER (OR BACK) NO USER SERVICEABLE PARTS INSIDE. REFER SERVICING TO QUALIFIED SERVICE PERSONNEL.		



This symbol indicates that dangerous voltage consisting a risk of electric shock is present within this unit.



This exclamation point symbol is intended to alert the user to the presence of important operating and maintenance (servicing) instructions in the literature accompanying the appliance.

## WARNING

- To reduce the risk of fire or electric shock, do not expose this appliance to rain or moisture.

## WARNING

1. Be sure to use only the standard adapter that is specified in the specification sheet. Using any other adapter could cause fire, electrical shock, or damage to the product.
2. Incorrectly connecting the power supply or replacing battery may cause explosion, fire, electric shock, or damage to the product.
3. Do not connect multiple controllers to a single adapter. Exceeding the capacity may cause abnormal heat generation or fire.
4. Securely plug the power cord into the power receptacle. Insecure connection may cause fire.
5. When installing the controller, fasten it securely and firmly. The fall of controller may cause personal injury.
6. Do not place conductive objects (e.g. screwdrivers, coins, metal parts, etc.) or containers filled with water on top of the controller. Doing so may cause personal injury due to fire, electric shock, or falling objects.
7. Do not install the unit in humid, dusty, or sooty locations. Doing so may cause fire or electric shock.
8. If any unusual smells or smoke come from the unit, stop using the product. In such case, immediately disconnect the power source and contact the service center. Continued use in such a condition may cause fire or electric shock.
9. If this product fails to operate normally, contact the nearest service center. Never disassemble or modify this product in any way. (SAMSUNG is not liable for problems caused by unauthorized modifications or attempted repair.)
10. When cleaning, do not spray water directly onto parts of the product. Doing so may cause fire or electric shock.

## CAUTION

1. Do not drop objects on the product or apply strong blows to it. Keep away from a location subject to excessive vibration or magnetic interference.
2. Do not install in a location subject to high temperature (over 50°C), low temperature (below 0°C), or high humidity. Doing so may cause fire or electric shock.
3. If you want to relocate the already installed product, be sure to turn off the power and then move or reinstall it.
4. Remove the power plug from the outlet when there is a lightning storm. Neglecting to do so may cause fire or damage to the product.

5. Keep out of direct sunlight and heat radiation sources. It may cause fire.
6. Install it in a place with good ventilation.
7. Avoid aiming the controller directly towards extremely bright objects such as sun.
8. Apparatus shall not be exposed to dripping or splashing and no objects filled with liquids, such as vases, shall be placed on the apparatus.
9. The Mains plug is used as a disconnect device and shall stay readily operable at any time.

#### FCC Statement

This device complies with part 15 of the FCC Rules. Operation is subject to the following two conditions :

- 1) This device may not cause harmful interference, and
- 2) This device must accept any interference received including interference that may cause undesired operation.

#### Caution

This equipment has been tested and found to comply with the limits for a Class A digital device, pursuant to part 15 of FCC Rules. These limits are designed to provide reasonable protection against harmful interference when the equipment is operated in a commercial environment.

This equipment generates, uses, and can radiate radio frequency energy and, if not installed and used in accordance with the instruction manual, may cause harmful interference to radio communications. Operation of this equipment in a residential area is likely to cause harmful interference in which case the user will be required to correct the interference at his own expense.

## IMPORTANT SAFETY INSTRUCTIONS

1. Read these instructions.
2. Keep these instructions.
3. Heed all warnings.
4. Follow all instructions.
5. Do not use this apparatus near water.
6. Clean only with dry cloth.
7. Do not block any ventilation openings. Install in accordance with the manufacturer's instructions.
8. Do not install near any heat sources such as radiators, heat registers, or other apparatus (including amplifiers) that produce heat.
9. Do not defeat the safety purpose of the polarized or grounding-type plug. A polarized plug has two blades with one wider than the other. A grounding type plug has two blades and a third grounding prong. The wide blade or the third prong is provided for your safety. If the provided plug does not fit into your outlet, consult an electrician for replacement of the obsolete outlet.
10. Protect the power cord from being walked on or pinched particularly at plugs, convenience receptacles, and the point where they exit from the apparatus.
11. Only use attachments/accessories specified by the manufacturer.
12. Use only with cart, stand, tripod, bracket, or table specified by the manufacturer, or sold with the apparatus.
13. Unplug this apparatus when a card is used. Use caution when moving the cart/ apparatus combination to avoid injury from tip-over.
14. Refer all servicing to qualified service personnel. Servicing is required when the apparatus has been damaged in any way, such as powersupply cord or plug is damaged, liquid has been spilled or objects have fallen into the apparatus, the apparatus has been exposed to rain or moisture, does not operate normally, or has been dropped.



# contents

---

## **PRODUCT INTRODUCTION**

5

- 5 Features
- 7 What's included
- 12 Cable Selection

## **INSTALLATION AND EXTERNAL CONNECTION**

13

- 13 Connecting the termination resistor and diode
- 14 Earth-grounding the communication cables
- 15 Power, Reader, and I/O Connection
- 18 Communication Line Connection

## **INITIALIZATION**

22

- 22 System Initialization
- 23 Board ID Setting

## **TROUBLESHOOTING**

24

- 24 Troubleshooting

## **PRODUCT SPECIFICATIONS**

26

- 26 Product Specifications

# product introduction

---

## FEATURES

---

### State-of-the-art Access Controller

---

SSA-P400(T)/SSA-P401(T) is a state-of-the-art door access controller device that provides a high level security system in an affordable price, meeting the needs in the security industry.

SSA-P400(T)/SSA-P401(T) can control access of 2-4 doors with simple manipulation and high level stability as well as its affordable cost.

You can specify up to 1000 ~ 20,000(30,000/ 40,000/50,000) instances of card registration to your preference, which you can delete or change as necessary. The built-in event memory can save up to 20,000 ~ 29,500(14,000/ 8,000/3,000) instances of entires and alerts according to the number of registered cards.

You can connect a wide range of readers via the 4 reader ports, and operate the reader in either RF Card or RF Card + PW mode.

15 independent input ports can be used to connect to various devices such as Exit Button, Door Contact Sensors, PIR Sensors, and Window Breakage Sensors to reinforce security.

You can use the keypad (optional) to configure your settings with easy.

You can establish the independent or network connection via RS-232 or RS-422 communications. SSA-P400(T)/SSA-P401(T) is equipped with a built-in TCP/IP module, which enables you to establish LAN communications. All settings including card registration information, I/O settings, Real Time Clock, Time Schedules and all Event Transaction Reports can be downloaded /uploaded from/to the host computer with software supporting a variety of reporting formats.

Installed and managed inside the security zone for preventing the risk of damage, SSA-P400 (P401) can implement a high level security access control system with multiple control options, best fit for access control and time & attendance management.

### Standalone Operation

---

By connecting to 4 card readers, you can use this product to control the access of the maximum of 4 doors. This controller determines to allow access by reading data from the card reader, and controls the open/close of the door relay and enables you to change other output settings. Upon receipt of an incoming external input signal (sensor or Exit button), it launches an output device such as the relay. This controller has an independent control system, assuring a normal operation regardless of problems on any other systems and, not affecting them in the reverse situation.

### Anti-Pass Back

---

A door has two card readers installed: one for the entrance, and the other for the exit, so anyone who enters should recognize his/her card on the reader at the entrance time before he can exit normally. If a person does not go under the card recognition process and just follows another person's way inside the door, the person is not allowed to exit when he/she recognizes the access card on exit card reader, and the anti-pass-back error (APB error) occurs which will be saved into the internal memory. And you can configure to output a certain signal through a specific port if such an error occurs. (Make your setting using the Application program (controlled access, time and attendance management, etc) – I/O Setup – APB Error) You can use Anti-Pass Back for controlling two doors independently or in synchronization with each other.

### Computer-based Management

---

All records of authorized or unauthorized accesses and any external signal will be saved in the internal memory. You can download such data onto your computer according to the specified communications protocol. With the downloaded data, you can store, process, and create a report based on your query (access and alert details, etc) on the central computer.

### Door Count Setup (2/3/4 doors)

---

As it is equipped with 4 card readers, you can use this product to control the access on a maximum of 4 doors. For controlling 2 doors, install reader 1 and reader 2 on door 1 while installing reader 3 and reader 4 on door 2. For controlling 3 doors, install reader 1 and reader 2 on door 1 while installing reader 3 on door 2, and reader 4 on door 3. For controlling 4 doors, install one reader on each door, totalling 4.

# product introduction

---

## Input Port Format Setup

---

15 input ports are provided by default. For these ports, you can specify if the format of the incoming signal is blocked (NO) or connected (NC) in normal operation. This setting will make all ports operate same regardless of the output status of the input device.

## Time Scheduling

---

You can specify a time range during which a specific operation is performed. You can specify a specific time range for a schedule code, which will be transferred to the applicable device. You can specify up to 5 different time intervals for a day, ranging from Monday to Sunday including holidays. Each time schedule code can produce a single different (or same) holiday code.

## Door Open Alarm and Forced Door Open Alarm

---

The Door Open Alarm function notifies the administrator that the door is still open if a door stays open after the normal door open time and the standby time. (The output signal can be transferred via the output port, data on any abnormal state will be stored in memory, which will be transferred upon request from the PC software. The Forced Door Open Alarm function produces an alert when the door is forced to open and makes an alert again if the door is still open after the timeout.

## I/O Settings

---

This product is equipped with 15 input ports, 12 relay output ports, and 3 TTL output ports. You can use the input ports to receive signals from the Exit button and the fire sensor, and utilize this product to meet various situations such as attaching the door lock to any of the 12 relays. You can also set the output time for these output ports.

## Holiday Setup

---

You can specify a holiday (legal holiday or bi-weekly holiday) excluding Sunday. You can specify up to 100 holidays for a single holiday code. (Access can be permitted only for an allowable time range according to your time schedule setting) A holiday code can be assigned to the time schedule code.

## ARM/DISARM

---

In the condition where the ARM/DISARM code is specified, if you enter the ARM/DISARM code and present the card of the administrator (with master permissions) to the reader, the device triggers the alarm mode where you can control the output signal in sync with the security system. In this mode, all connected readers will not take the card input any further.

## Duress Mode

---

This is used in a situation where you should open the door inevitably by a robber insisting to do so. Open the door by entering the two-digit duress alarm password and pressing the **[ENT]** button before presenting the registered card (or recognizing the card number), in the meantime this forcibly duress situation will be notified to the PC application.

## Two Men Operation Mode

---

This will allow access by visitors only under the control of the visitor guide. Access will be permitted only if two cards are presented within a specified time (10 seconds).

## Dual Door Time Control

---

This allows you to specify two different settings for the entrance door control time according to the passers-by. However, this can not be enabled with the ARM/DISARM function at the same time.

## Data Maintenance

---





In the event of power failure, the controller retains all card information and the access/alert history (event data) until it is damaged on the memory.

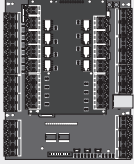

- You can use the application program (SAMS Basic) to configure all these settings to your preference.

## WHAT'S INCLUDED

Check if the following items are included in the product package.

	
Main Unit	Quick Guide
	
CD Manual	Diode (x12) (UF4004, 1N4001~4007)

# product introduction

## Main Board

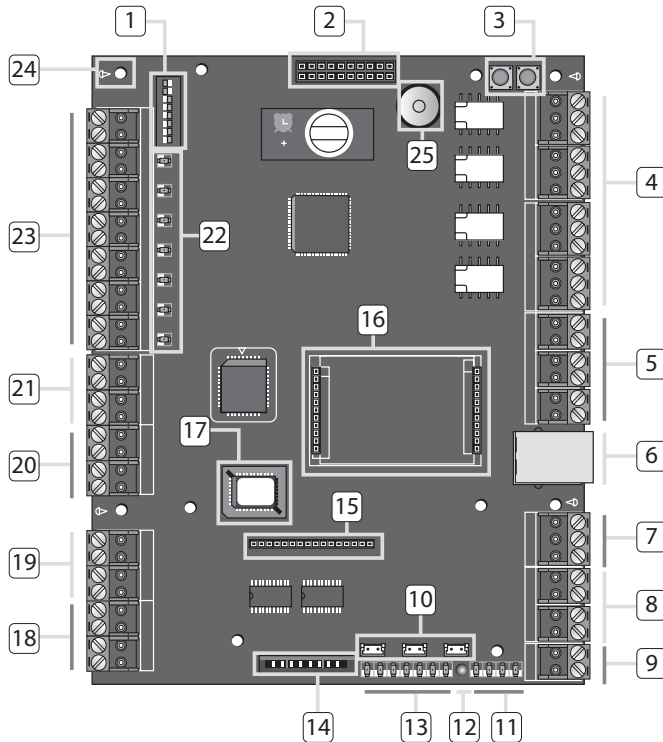

<b>1</b>	<b>Board ID Setup Switch</b>	The address number specified by the address setup switch should match that of the host computer as it is used for communications with the host computer.
<b>2</b>	<b>I/O Board Connection Port</b>	Communication ports to connect to the I/O board, which include Input #8 through Input #15 and Output #8 through Output #15.
<b>3</b>	<b>System Initialization Switch</b>	Pressing both of the switches at the same time for about 2 seconds will sound initialization ready beep. Releasing both switches will stop the beep, and restarts the system after the initialization.
<b>4</b>	<b>Output (Relay #1 ~ Relay #4) Ports</b>	4 relay outputs (FORM-C(COM, NO, NC)) are provided. (DC12~18V, Max Current 2A)
<b>5</b>	<b>Output (TTL #1 ~ TTL #3) Ports Address Setup Switch</b>	3 TTL output ports are provided. The voltage depends on the output occurrence, DC 0V for no output occurrence, and DC 5V for any output occurrence.



<b>6</b>	<b>RJ-45</b>	Connect the LAN cable for TCP/IP communications.
<b>7</b>	<b>RS-232 Communication Port</b>	One RS-232 communication port is provided. Used to exclusively connect to a PC in a local area.
<b>8</b>	<b>RS-422 Communication Port</b>	One RS-422 communication port is provided. You can establish up to 32 multi-drop communications.
<b>9</b>	<b>Power Connection Port</b>	DC +12V is used for the power source.
<b>10</b>	<b>LED Extension Port</b>	Port used to extend the power and communication indicators so that they can display in an external device.
<b>11</b>	<b>TCP/IP Module LED Indicator</b>	For TCP/IP module communications, the status of the TCP/IP module will be provided additionally.
<b>12</b>	<b>Power LED Indicator</b>	Power connection status indicator. It always stays ON while the power is applied.
<b>13</b>	<b>Output LED Indicator</b>	Output status indicator for the output port. A flashing indicator denotes the occurrence of any output.
<b>14</b>	<b>Keypad Connection Port</b>	Optional item.
<b>15</b>	<b>LCD Connection Port</b>	Optional item.
<b>16</b>	<b>TCP/IP Module Connection Port</b>	The TCP/IP module is optional so it is not provided by default. Communication can be established using the built-in TCP/IP module. Communication with the PC can be established using the built-in TCP/IP module.
<b>17</b>	<b>Firmware ROM</b>	This must be replaced before the firmware update; you can check the current firmware version.
<b>18</b>	<b>Reader #1 Port</b>	The first reader connection port.
<b>19</b>	<b>Reader #2 Port</b>	The second reader connection port.
<b>20</b>	<b>Reader #3 Port</b>	The third reader connection port.
<b>21</b>	<b>Reader #4 Port</b>	The fourth reader connection port.
<b>22</b>	<b>Input LED Indicator</b>	Indicates the status of the incoming signal to the input port. A flashing indicator denotes the occurrence of any signal to the input port (NC-type input device). In the NO-type connection, the LED indicator turns on if no sensor signal occurs while it turns off if any signal occurs.
<b>23</b>	<b>Input Ports (Input #1 ~ #7)</b>	Input ports #1 ~ #7.
<b>24</b>	<b>Fixing Hole</b>	Fixing hole used to install the product through the bezel, using screws.
<b>25</b>	<b>Buzzer</b>	It will sound beeps on system initialization to the configured output depending on the buzzer control settings.

# product introduction

## I/O Board

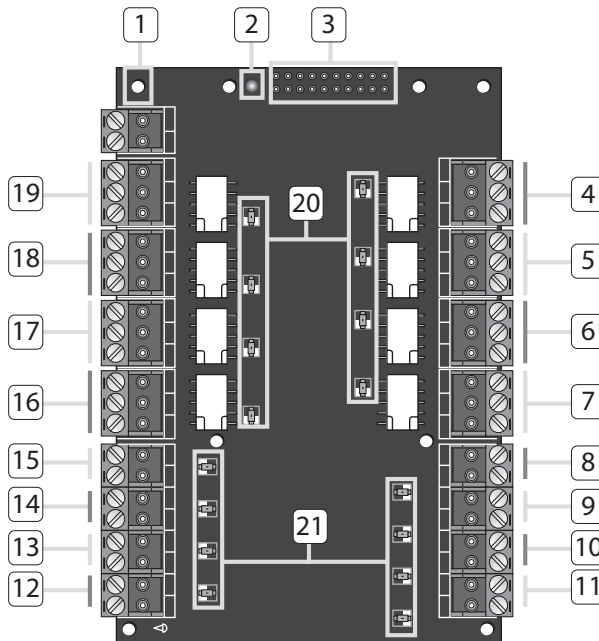

<b>1</b> Fixing Hole	Used to fix the main board to the I/O board using screws.
<b>2</b> Power LED Indicator	The red indicator turns on in the normal power supply condition.
<b>3</b> Main Board Connection Port	Connector used to connect to the main board.
<b>4</b> Output (Relay #5) Port	Output port #5.
<b>5</b> Output (Relay #6) Port	Output port #6 (FORM-C).
<b>6</b> Output (Relay #7) Port	Output port #7 (FORM-C).
<b>7</b> Output (Relay #8) Port	Output port #8 (FORM-C).

<b>8</b>	<b>INPUT #8</b>	Input port #8.
<b>9</b>	<b>INPUT #9</b>	Input port #9.
<b>10</b>	<b>INPUT #10</b>	Input port #10.
<b>11</b>	<b>INPUT #11</b>	Input port #11.
<b>12</b>	<b>INPUT #12</b>	Input port #12.
<b>13</b>	<b>INPUT #13</b>	Input port #13.
<b>14</b>	<b>INPUT #14</b>	Input port #14.
<b>15</b>	<b>INPUT #15</b>	Input port #15.
<b>16</b>	<b>Output (Relay #9) Port</b>	Output port #9 (FORM-C).
<b>17</b>	<b>Output (Relay #10) Port</b>	Output port #10 (FORM-C).
<b>18</b>	<b>Output (Relay #11) Port</b>	Output port #11 (FORM-C).
<b>19</b>	<b>Output (Relay #12) Port</b>	Output port #12 (FORM-C).
<b>20</b>	<b>Output LED Indicator</b>	LED Indicator that indicates the output status.
<b>21</b>	<b>Input LED Indicator</b>	LED Indicator that indicates the input status.

# product introduction

## CABLE SELECTION

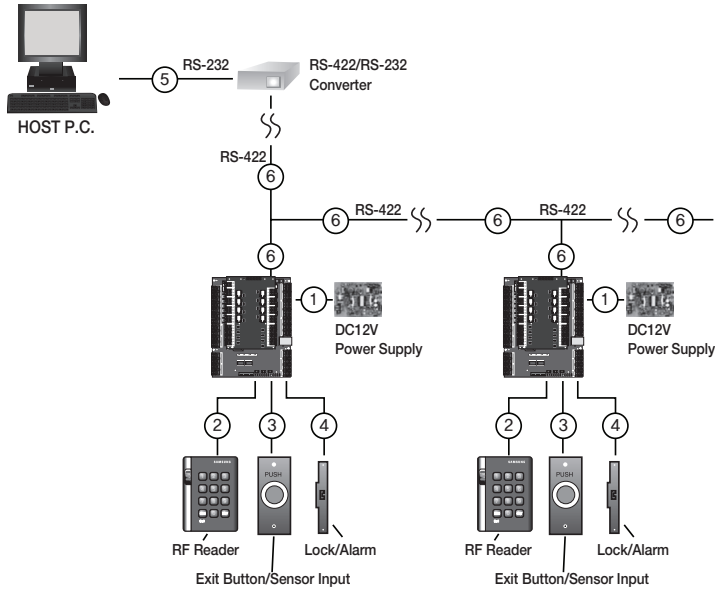

Item	Cable Type
<b>1</b> Power (DC12V) DC Power → Device	Belden #9409, 18 AWG 2 Conductor, Unshielded
<b>2</b> Reader (power and data) External reader → Device	Belden #9512, 22 AWG 4 Conductor, Shielded Belden #9514, 22 AWG 8 Conductor, Shielded
<b>3</b> Door Contact Sensor Exit Button Sensor Input Input → Device	Belden #9512, 22 AWG 4 Conductor, Shielded Belden #9514, 22 AWG 8 Conductor, Shielded
<b>4</b> Door Lock Alarm Device Lock (Alarm) → Device	Belden #9409, 18AWG 2 Conductor, Unshielded
<b>5</b> RS-232 Cable Converter → Host P.C.	Belden #9829, 24 AWG 2-twisted pair, Shielded
<b>6</b> RS-485 Cable Device → Device Device → Converter	Belden #9829, 24 AWG 2-twisted pair, Shielded
RS-422 Cable Device → Device Device → Converter	Belden #9830, 24 AWG 3-twisted pair, Shielded



\* The cables should be thick enough to allow the maximum current consumed by the reader.

# installation and external connection

## CONNECTING THE TERMININATION RESISTOR AND DIODE

### Termination Resistor

A resistor is inserted for matching the line's impedance to prevent distortion and reduction in RS-422 or RS-485 long distance data communications, which is referred to as termination resistor.

Note that termination resistors of lower than 90Ω are not allowed, neither more than one termination resistor is accepted for the communications system.

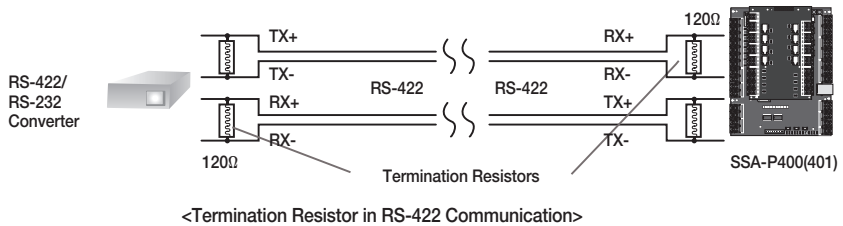
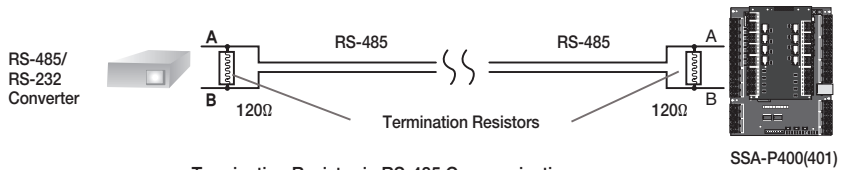

● INSTALLATION AND EXTERNAL CONNECTION

### Bypass Diode Connection

If you connected an inductor (door lock or alarm device) to the output relay, there should occur a voltage surge while the inductor was between turning on and turning off. If you do not connect a bypass diode to the relay, the voltage surge will cause damage to the electric circuit of the controller. To reduce this surge, it is recommended to connect a bypass diode to the relay.

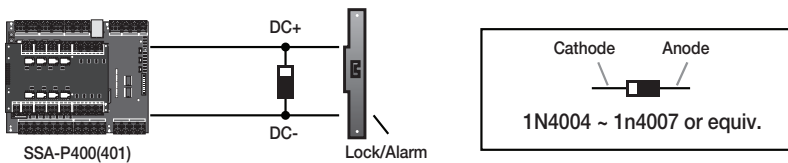

# installation and external connection

## EARTH-GROUNDING THE COMMUNICATION CABLES

We recommend you to use a proper grounding system for the communication cables.

The best grounding method is to earth-ground the shield wire of the communication cable. However, the earth-grounding of the communication cable is not easy at all, and it also causes an increased installation cost. There are three grounding points available for installation:

1. Earth Ground
2. Chassis Ground
3. Power Ground

The most important thing about the earth-grounding lies in connecting neither end of the shield wire to the grounding system simultaneously. This will cause a current flow through the shield wire when the voltage level of both ends of the shield wire is not equal and this current flow will introduce some noise and interference to communications.

It is recommended to connect **ONLY** one end of the shield wire of the communication cable to the grounding system. If you can locate an earth grounding point nearby, connect one end of the shield wire to that point. If you could hardly locate an earth grounding point nearby, connect one end of the shield wire to the chassis ground point. If you could locate neither of an earth or chassis grounding point nearby, connect one end of the shield wire to the power ground point (GND). Note that if the chassis is not properly earthed and floated from the ground level, then grounding communication cable to the chassis will produce the worst communication. If this is the case, use the power ground point rather than the chassis ground.

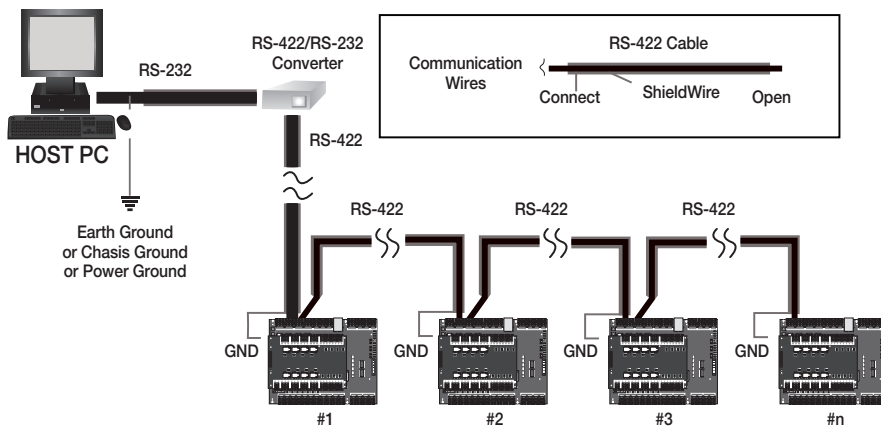

# POWER, READER, AND I/O CONNECTION

## Power Connection

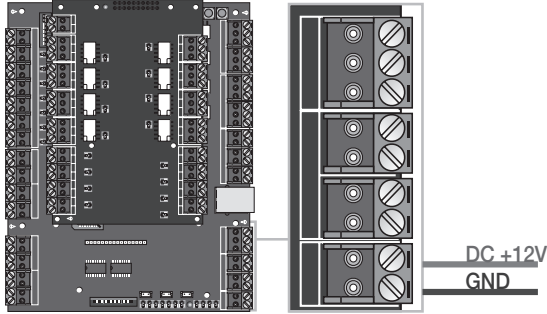

- Connect the plus (+) line of DC 12V to the corresponding port (+12V).
- Connect the GND (-) line of DC 12V to the GND (-) port.

## Reader Connection

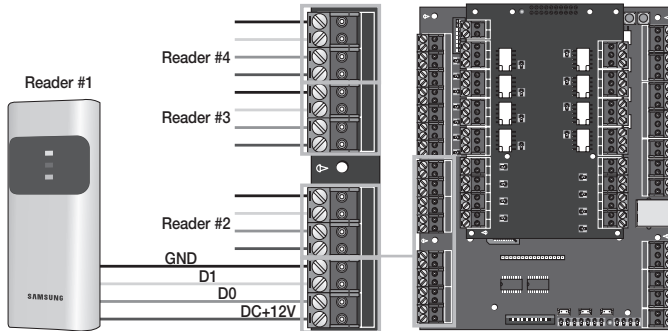

- Connect the plus (+) line of the reader to the corresponding port (DC +12V).
- Connect the minus (-) line of the reader to the GND (-) port.
- Connect the data 0 line of the reader to its port data 0 (D0).
- Connect the data 1 line of the reader to its port data 1 (D1).

	Door Number	External Reader	Internal Reader	Exit Button
Two Door Control	1	Reader #1	Reader #2	None
	2	Reader #3	Reader #4	None
Three Door Control	1	Reader #1	Reader #2	None
	2	Reader #3	None	Internal Exit Button
Four Door Control	3	Reader #4	None	Internal Exit Button
	1	Reader #1	None	Internal Exit Button
	2	Reader #2	None	Internal Exit Button
	3	Reader #3	None	Internal Exit Button
	4	Reader #4	None	Internal Exit Button

- Refer to the list of compatible readers.
  - SSA-P400(T) : 26Bit Wiegand Reader
  - SSA-P401(T) : 34Bit Wiegand Reader

# installation and external connection

## Input Connection

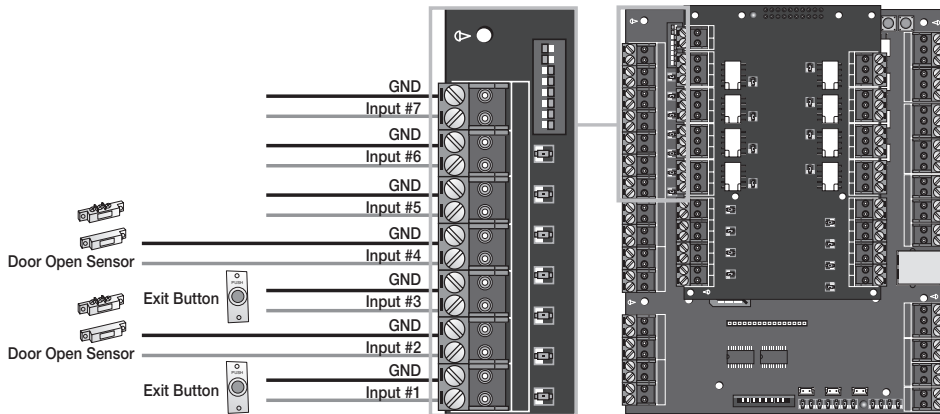

### - Exit Button Connection (Input #1, Input #3)

1. Connect one line of the Exit button to an input port (Door 1: Input #1, Door 2: Input #3) of the Exit button.
2. Connect the other line of the Exit button to GND (-).

### - Door Sensor Connection (Input #2, Input #4)

1. Connect one line (COM) of the door open/close sensor to the input port (Door 1: Input #2, Door 2: Input #4) of the door sensor.
2. Connect the other line (NC) of the door sensor to GND (-).

	Door Number	Exit Button	Door Open Sensor	Note
Two Door Control	1	Input #1	Input #2	
	2	Input #3	Input #4	
Three Door Control	1	Input #1	Input #2	
	2	Input #8	Input #9	I/O Board
	3	Input #10	Input #11	I/O Board
Four Door Control	1	Input #1	Input #2	
	2	Input #3	Input #4	
	3	Input #8	Input #9	I/O Board
	4	Input #10	Input #11	I/O Board



## Output Connection

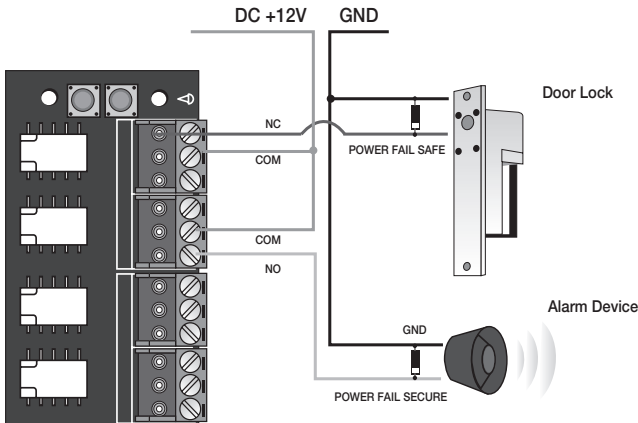

### - If the door lock is in POWER FAIL SAFE mode: (Door 1: Relay #1, Door 2: Relay #3)

1. Connect the COM line of the Door Lock relay to DC +12V.
2. Connect the plus (+) line of the Door Lock to the Normal Close (NC) line of the Door Lock relay.
3. Connect the minus (-) line of the Door Lock to GND (-).

### - If the Door Lock is in POWER FAIL SECURE mode: (Door 1: Relay #1, Door 2: Relay #3)

1. Connect the COM line of the relay to DC +12V.
2. Connect the plus (+) line of the Door Lock to the Normal Open (NO) line of the Door Lock relay.
3. Connect the minus (-) line of the Door Lock to GND (-).

### Alarm Device Connection (Door 1 Alarm: Relay #2, Door 2 Alarm: Relay #4)

1. Connect the COM line of the alarm device relay to DC +12V.
2. Connect the plus (+) line of the alarm device to the NO line of the alarm device relay.
3. Connect the minus (-) line of the alarm device to GND (-).

	Door Number	Door Lock	Alarm Device	Note
Two Door Control	1	Relay Output #1	Relay Output #2	
	2	Relay Output #3	Relay Output #4	
Three Door Control	1	Relay Output #1	Relay Output #2	
	2	Relay Output #8	Relay Output #9	I/O Board
	3	Relay Output #10	Relay Output #11	I/O Board
Four Door Control	1	Relay Output #1	Relay Output #2	
	2	Relay Output #3	Relay Output #4	
	3	Relay Output #8	Relay Output #9	I/O Board
	4	Relay Output #10	Relay Output #11	I/O Board

# installation and external connection

## COMMUNICATION LINE CONNECTION

### RS-232 Communication Port Connection

A 9-pin connector for serial communication is required to make connection to the PC.

Connect the 9 pin connector for RS-232 communications as follows:



9-Pin Female Connector

1. Connect RS-232 TX to pin #2 of the 9-pin connector.
2. Connect RS-232 RX to pin #3 of the 9-pin connector.
3. Connect RS-232 GND to pin #5 of the 9-pin connector.
4. Connect the serial communication connector to the serial COM port of the computer.
5. Install and launch the application (SAMS).

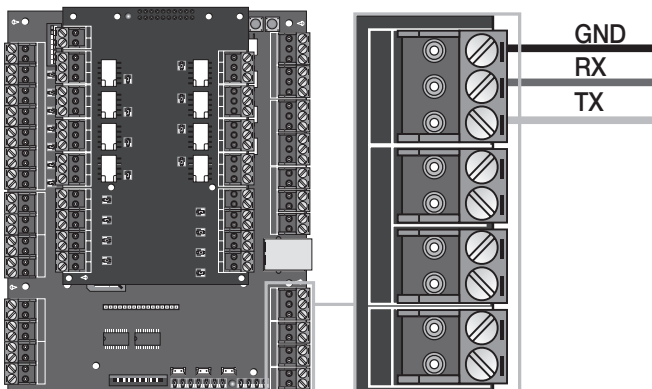

- Check the location of the communication port.

## RS-422 Communication Port Connection (Standalone)

The RS-422/RS-232 converter is required to establish RS-422 communications. Connect the 9-pin connector of the RS-422/RS-232 converter as follows:

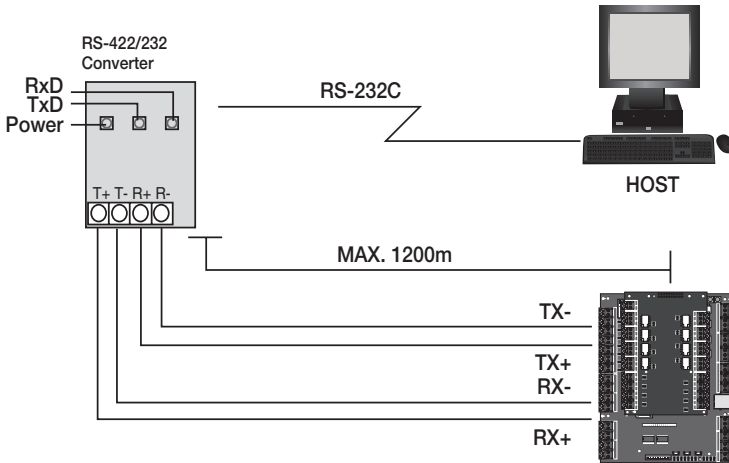

1. Connect RS-422 TX(-) to the RX(-) port of the converter.
2. Connect RS-422 TX(+) to the RX(+) port of the converter.
3. Connect RS-422 RX(-) to the TX(-) port of the converter.
4. Connect RS-422 RX(+) to the TX(+) port of the converter.
5. Connect the 9-pin connector of the RS-422/RS-232 converter to the serial COM port of the computer.
6. Install and launch the application (SAMS).

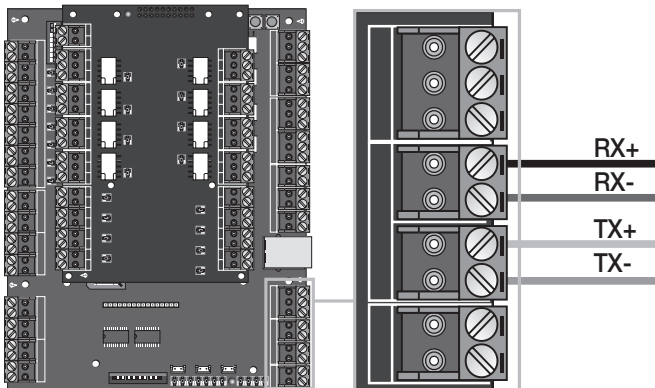

- Check the location of the communication port.

# installation and external connection

## RS-422 Communication Port Connection (Multiple Units)

The RS-422/RS-232 converter is required to establish RS-422 communications.

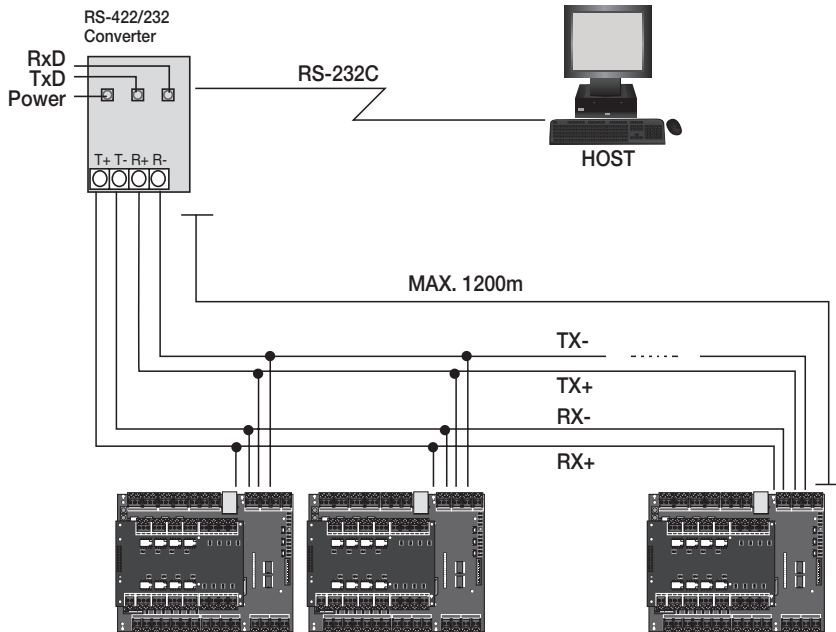

- Follow the guidelines below to make connection between devices.

1. Connect TX(-) of one device to TX(-) of other one.
2. Connect TX(+) of one device to TX(+) of other one.
3. Connect RX(-) of one device to RX(-) of other one.
4. Connect RX(+) of one device to RX(+) of other one
5. Set a unique board ID for each product.

- Follow the guidelines below to make connection between the terminal device and the RS-422 9-pin connector of the RS-422/RS-232 converter.

1. Connect RS-422 TX(-) to the RX(-) port of the converter.
2. Connect RS-422 TX(+) to the RX(+) port of the converter.
3. Connect RS-422 RX(-) to the TX(-) port of the converter.
4. Connect RS-422 RX(+) to the TX(+) port of the converter.
5. Connect the 9-pin connector of the RS-422/RS-232 converter to the COM port of the computer.
6. Install and launch the application (SAMS).

## TCP/IP Communication Port Connection

### 1) TCP/IP Communication Configuration

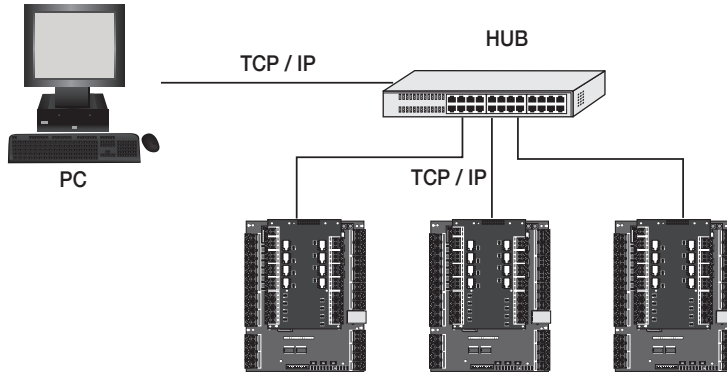

### 2) TCP/IP Connection

Connect the LAN cable to the TCP/IP RJ-45 jack as shown.  
(applicable only to SSA-P400T / SSA-P401T)

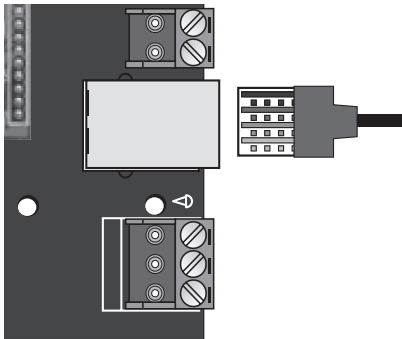

1. Connect the RJ45 jack of the unit to the RJ45 plug, the LAN cable of the network system.
2. Set a unique communication address (COMM ADDR) for each unit
3. Install and launch the application (SAMS).

# initialization

---

## SYSTEM INITIALIZATION

---

### Initializing the system using the Initialize switch

---

Apply the power and initialize the system by using the initialization switch.

1. Locate the Initialize switch (  ) on the upper right corner and press both switches simultaneously.
  - Pressing both of the switches at the same time for about 2 seconds will sound initialization ready beep. Releasing both switches will stop the beep, and restarts the system after the initialization.

Initialize Switch

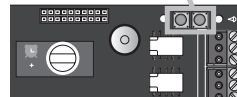

-  ■ Initializing the system restores all your settings to the default, consequently all ID data will be lost.

## BOARD ID SETTING

Each device in the multi-serial communication connection is assigned a unique number to identify each other.

1. The initial value of the switch is "0", and all of the 8 switches are defaulted to OFF.
2. Each switch has a unique value, and the board ID is the sum of the values of the switches.
  - You can specify between 0 and 255 for the board ID.

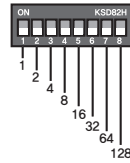
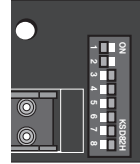

❖ Refer to the example below for the board ID.

Example 1	Example 2	Example 3
$1+2 = 3$ (Board ID = 3)	$4+32 = 36$ (Board ID = 36)	$1+2+4+8+16+32+64+128 = 255$ (Board ID = 255)

The board ID is the unique address of the device so it should not be duplicated.

# troubleshooting

## TROUBLESHOOTING

If the product does not work properly, please check the followings before contacting us. If the trouble persists, please contact the SAMSUNG Customer Service near you.

Problem	Action
<p><b>Can I specify RF only or RF+P/W mode differently according to the card?</b></p>	<ol style="list-style-type: none"> <li>1) It is not available.</li> <li>2) The mode is defined for each reader device, not the card. Thus, you can not specify the mode for each card differently.</li> </ol>
<p><b>Ever since I mass-transferred data using the PC application, some cards are not allowed for access.</b></p>	<ol style="list-style-type: none"> <li>1) You might have not saved card information to the PC, but just to the device when registering card using the PC application.</li> <li>2) Check if there is a registered, but disallowed card in the PC.</li> <li>3) For an unregistered card, try to enter it again and save to the PC before transferring to the device.</li> <li>4) The Mass Transfer/Group Transfer function of the PC application will delete all card data in the device before transferring the PC data to the device. As such, if you usually register one card on a daily basis, you may not save it to the PC but transfer to the device, which causes unsaved card numbers not to be registered with the device in the operation of a mass-transfer.</li> <li>5) If this is not the case, the problem may be caused by the defective of an internal circuit. Contact the nearest customer service for technical assistance.</li> </ol>
<p><b>The RF card works normally, but the key input (for the card number) using the keypad does not work properly.</b></p>	<p>Use the provided software program to check the use of the keypad while the reader is operating in a certain mode. Enable the use of the keypad before downloading data to the device.</p>
<p><b>The reader reads a card normally but no reaction is made by the device or an irrelevant card number is displayed.</b></p>	<ol style="list-style-type: none"> <li>1) Check the power source of the reader. (Check if the LED indicator of the reader is blinking when it has read a card.)</li> <li>2) Check if the reader works properly. (Disconnect the reader from the system and use a measuring device such as an oscilloscope to measure the output port of the reader.)</li> <li>3) Check if the reader is properly connected to the system (device).             <ul style="list-style-type: none"> <li>- Check if the Wiegand communication lines between the reader and the system are properly established. (D0, D1)</li> <li>- The Wiegand communication line should be connected to GND. (A different power source may be fine but the earth-grounding point should be connected to GND of the device.)</li> </ul> </li> <li>4) If you find the output signal from the device but with severe noise when using a measuring device to measure the Wiegand communication line, please check the followings:             <ul style="list-style-type: none"> <li>- Connect the shield wire and the spare wire of the cable to GND.</li> <li>- Use the repeater.</li> </ul> </li> <li>5) If the problem persists after performing all the checkpoints above, contact the customer service for technical help.</li> </ol>



Problem	Action																																																
<p><b>No communication is available when the system is in sync with the PC.</b></p>	<p>1) Check the communication settings between the PC application and the device.</p> <ul style="list-style-type: none"> <li>- Check the board ID (COMM address) and match it with that of the PC application.</li> <li>- Specify a unique board ID (COMM address) for each of the multiple devices.</li> <li>- Check the baud rate if it matches with the PC application.</li> <li>- If you initialize the device, it will be defaulted to 9,600bps.</li> <li>- Check if the communication port of the PC matches that of the PC application.</li> <li>- Check the communication settings of the PC application.</li> </ul> <p>Parity Bit : NONE, Data Bit: 8bit, Stop Bit: 1bit</p> <p>2) Check the connection status of RS-232 and RS-422.</p> <table border="1" data-bbox="568 699 1091 892"> <thead> <tr> <th colspan="2">RS-232</th> <th colspan="3">RS-422 (Independent Communication)</th> </tr> </thead> <tbody> <tr> <td>SSA-P400</td> <td>PC</td> <td>SSA-P400</td> <td>RS-232/RS-422 Converter</td> <td>PC</td> </tr> <tr> <td>TX Port</td> <td>RX</td> <td>RX(-)</td> <td>TX(-)</td> <td rowspan="4">Connected to the RS-232 cable of the converter</td> </tr> <tr> <td>RX Port</td> <td>TX</td> <td>RX(+)</td> <td>TX(+)</td> </tr> <tr> <td>GND</td> <td>GND</td> <td>TX(-)</td> <td>RX(-)</td> </tr> <tr> <td></td> <td></td> <td>TX(+)</td> <td>RX(+)</td> </tr> </tbody> </table> <table border="1" data-bbox="568 904 1091 1078"> <thead> <tr> <th colspan="4">Rs-422 (Multi-Unit Communication)</th> </tr> </thead> <tbody> <tr> <td>SSA-P400</td> <td>SSA-P400</td> <td>RS-232/RS-422</td> <td>PC</td> </tr> <tr> <td>RX(-)</td> <td>RX(-)</td> <td>TX(-)</td> <td rowspan="4">Connected to the RS-232 cable of the converter</td> </tr> <tr> <td>RX(+)</td> <td>RX(+)</td> <td>TX(+)</td> </tr> <tr> <td>TX(-)</td> <td>TX(-)</td> <td>RX(-)</td> </tr> <tr> <td>TX(+)</td> <td>TX(+)</td> <td>RX(+)</td> </tr> </tbody> </table> <p>For RS-422 communications, install a termination resistor at the point where the system is connected to the RS-422/RS-232 converter of the PC.          (Install a 120Ω termination resistor between the RX+ and the RX- terminals on the device side, another 120Ω between the TX+ and the TX- terminals; the same should be done to the converter. If you are not sure about the wiring, contact the customer service for your help.)          If the problem persists after you followed the instructions above, this may be caused by the defective of an internal circuit. Contact the customer service.</p> <p>* If no communication is established after you tried to do so with multiple devices, pick just one device and connect it to the RS-232/RS-422 converter, and to the PC. Then, check if there is any communication available.</p>	RS-232		RS-422 (Independent Communication)			SSA-P400	PC	SSA-P400	RS-232/RS-422 Converter	PC	TX Port	RX	RX(-)	TX(-)	Connected to the RS-232 cable of the converter	RX Port	TX	RX(+)	TX(+)	GND	GND	TX(-)	RX(-)			TX(+)	RX(+)	Rs-422 (Multi-Unit Communication)				SSA-P400	SSA-P400	RS-232/RS-422	PC	RX(-)	RX(-)	TX(-)	Connected to the RS-232 cable of the converter	RX(+)	RX(+)	TX(+)	TX(-)	TX(-)	RX(-)	TX(+)	TX(+)	RX(+)
RS-232		RS-422 (Independent Communication)																																															
SSA-P400	PC	SSA-P400	RS-232/RS-422 Converter	PC																																													
TX Port	RX	RX(-)	TX(-)	Connected to the RS-232 cable of the converter																																													
RX Port	TX	RX(+)	TX(+)																																														
GND	GND	TX(-)	RX(-)																																														
		TX(+)	RX(+)																																														
Rs-422 (Multi-Unit Communication)																																																	
SSA-P400	SSA-P400	RS-232/RS-422	PC																																														
RX(-)	RX(-)	TX(-)	Connected to the RS-232 cable of the converter																																														
RX(+)	RX(+)	TX(+)																																															
TX(-)	TX(-)	RX(-)																																															
TX(+)	TX(+)	RX(+)																																															

# product specifications

## PRODUCT SPECIFICATIONS

Item	SSA-P400	SSA-P400T	SSA-P401	SSA-P401T
Users	1,000 ~ 20,000 / 30,000 / 40,000 / 50,000 Users (Default :20,000)			
Event Buffer	20,000 ~ 29,500 / 3,000 / 8,000 / 14,000 (Default : 29,500)			
Power / Current	DC 12V, MAX. 380mA	DC 12V, MAX.430mA	DC 12V, MAX. 380mA	DC 12V, MAX.430mA
Reader Port	4ea: 26bit Wiegand, 4 / 8bit Burst for PIN		4ea: 34bit Wiegand, 4 / 8bit Burst for PIN	
Door Open Time	00~99 Sec. (Default 3Sec.)			
Communication	RS232 / RS422 / RS485	RS232 / RS422 / RS485, TCP/IP	RS232 / RS422 / RS485	RS232 / RS422 / RS485, TCP/IP
Baud Rate(bps)	9,600bps			
Input Port	15ea			
Output Port	12ea : 2 FORM-C Relay Output (COM, NO, NC) / DC12V~18V, Rating Max.2A			
	3ea: TTL Output / DC5V, Rating Max.20mA			
LED Indicator	38ea : 21 LED Indicators (Red, Green and Yellow) 17 LED Indicators (Red, Yellow)			
Beeper	Piezo Buzzer			
Operating Temperature	0°C to +50°C			
Operating Humidity	10% to 90% relative humidity non-condensing			
Color / Material	Black/ PCB			
Dimension (W x H x D(mm))	145 x 185 x 18			
Weight	340g	350g	340g	350g



## **Correct Disposal of This Product (Waste Electrical & Electronic Equipment)**

(Applicable in the European Union and other European countries with separate collection systems)



This marking on the product, accessories or literature indicates that the product and its electronic accessories (e.g. charger, headset, USB cable) should not be disposed of with other household waste at the end of their working life. To prevent possible harm to the environment or human health from uncontrolled waste disposal, please separate these items from other types of waste and recycle them responsibly to promote the sustainable reuse of material resources.

Household users should contact either the retailer where they purchased this product, or their local government office, for details of where and how they can take these items for environmentally safe recycling.

Business users should contact their supplier and check the terms and conditions of the purchase contract.

This product and its electronic accessories should not be mixed with other commercial wastes for disposal.

## **Correct disposal of batteries in this product**

(Applicable in the European Union and other European countries with separate battery return systems.)



This marking on the battery, manual or packaging indicates that the batteries in this product should not be disposed of with other household waste at the end of their working life. Where marked, the chemical symbols Hg, Cd or Pb indicate that the battery contains mercury, cadmium or lead above the reference levels in EC Directive 2006/66. If batteries are not properly disposed of, these substances can cause harm to human health or the environment.

To protect natural resources and to promote material reuse, please separate batteries from other types of waste and recycle them through your local, free battery return system.