



Cisco Video Surveillance 4300E and 4500E High-Definition IP Camera User Guide

Americas Headquarters

Cisco Systems, Inc.
170 West Tasman Drive
San Jose, CA 95134-1706
USA
<http://www.cisco.com>
Tel: 408 526-4000
800 553-NETS (6387)
Fax: 408 527-0883

NOTICE. ALL STATEMENTS, INFORMATION, AND RECOMMENDATIONS IN THIS MANUAL ARE BELIEVED TO BE ACCURATE BUT ARE PRESENTED WITHOUT WARRANTY OF ANY KIND, EXPRESS OR IMPLIED. USERS MUST TAKE FULL RESPONSIBILITY FOR THEIR APPLICATION OF ANY PRODUCTS.

THE SOFTWARE LICENSE AND LIMITED WARRANTY FOR THE ACCOMPANYING PRODUCT ARE SET FORTH IN THE INFORMATION PACKET THAT SHIPPED WITH THE PRODUCT AND ARE INCORPORATED HEREIN BY THIS REFERENCE. IF YOU ARE UNABLE TO LOCATE THE SOFTWARE LICENSE OR LIMITED WARRANTY, CONTACT YOUR CISCO REPRESENTATIVE FOR A COPY.

The Cisco implementation of TCP header compression is an adaptation of a program developed by the University of California, Berkeley (UCB) as part of UCB's public domain version of the UNIX operating system. All rights reserved. Copyright © 1981, Regents of the University of California.

NOTWITHSTANDING ANY OTHER WARRANTY HEREIN, ALL DOCUMENT FILES AND SOFTWARE OF THESE SUPPLIERS ARE PROVIDED "AS IS" WITH ALL FAULTS. CISCO AND THE ABOVE-NAMED SUPPLIERS DISCLAIM ALL WARRANTIES, EXPRESSED OR IMPLIED, INCLUDING, WITHOUT LIMITATION, THOSE OF MERCHANTABILITY, FITNESS FOR A PARTICULAR PURPOSE AND NON-INFRINGEMENT OR ARISING FROM A COURSE OF DEALING, USAGE, OR TRADE PRACTICE.

IN NO EVENT SHALL CISCO OR ITS SUPPLIERS BE LIABLE FOR ANY INDIRECT, SPECIAL, CONSEQUENTIAL, OR INCIDENTAL DAMAGES, INCLUDING, WITHOUT LIMITATION, LOST PROFITS OR LOSS OR DAMAGE TO DATA ARISING OUT OF THE USE OR INABILITY TO USE THIS MANUAL, EVEN IF CISCO OR ITS SUPPLIERS HAVE BEEN ADVISED OF THE POSSIBILITY OF SUCH DAMAGES.

Cisco and the Cisco Logo are trademarks of Cisco Systems, Inc. and/or its affiliates in the U.S. and other countries. A listing of Cisco's trademarks can be found at www.cisco.com/go/trademarks. Third party trademarks mentioned are the property of their respective owners. The use of the word partner does not imply a partnership relationship between Cisco and any other company. (1005R)

Cisco Video Surveillance 4300E and 4500E High-Definition IP Camera User Guide
Copyright © 2009–2011 Cisco Systems, Inc. All rights reserved.



CONTENTS

Preface v

Overview v

Organization v

Obtaining Documentation, Obtaining Support, and Security Guidelines v

CHAPTER 1

Overview 1-1

IP Camera Features 1-1

IP Camera Physical Details 1-3

DC Auto Iris Lens Connector Pinouts 1-6

Package Contents 1-6

CHAPTER 2

Getting Started 2-1

Installing the IP Camera 2-1

Performing the Initial Setup of the IP Camera 2-5

Accessing the IP Camera 2-6

Understanding the IP Camera User Interface 2-8

IP Camera Window Links 2-8

IP Camera Windows 2-9

Adjusting Back Focus on the IP Camera 2-10

Powering the IP Camera On or Off 2-11

Resetting the IP Camera 2-11

Managing the Local Storage 2-11

Downloading and Installing the USB Download Decryption Utility 2-12

Formatting the USB Flash Drive 2-12

Downloading Encrypted Video Files from the USB Flash Drive 2-13

Deleting Encrypted Video Files from the USB Flash Drive 2-13

Decrypting Encrypted Video Files 2-14

CHAPTER 3

Configuring and Managing the IP Camera 3-1

Accessing Navigating the Configuration Windows 3-1

Feature Setup Windows 3-2

Streaming Settings Window 3-3

Camera Settings Window 3-6

- Video Overlay Settings Window 3-8
- IO Ports Settings Window 3-9
- Pan Tilt Settings Window 3-10
- Event Notification Window 3-11
- Patrol Sequence Window 3-16
- Analytics Windows 3-18
- Network Setup Windows 3-18
 - Basic Settings Window 3-18
 - IP Addressing Window 3-19
 - Time Settings Window 3-20
 - Discovery Settings Window 3-22
 - SNMP Settings Window 3-23
 - 802.1x Settings Window 3-25
 - IP Filter Settings Window 3-26
 - QoS Settings Window 3-27
- Administration Windows 3-28
 - Account Initialization Window 3-28
 - User Settings Window 3-30
 - Maintenance Settings Window 3-31
 - Firmware Settings Window 3-33
 - Device Processes Window 3-34
 - Password Complexity Window 3-35
- Log Windows 3-35
 - Log Setup Settings Window 3-36
 - Local Log Window 3-38

CHAPTER 4 **Viewing Live Video** 4-1

CHAPTER 5 **Troubleshooting** 5-1

INDEX



Preface

Overview

This document, *Cisco Video Surveillance 4300E and 4500E High-Definition IP Camera User Guide*, provides information about installing, configuring, using, managing, and troubleshooting the Cisco 4300E and 4500E Video Surveillance High-Definition IP Cameras.

Organization

This manual is organized as follows:

Chapter 1, “Overview”	Provides an overview of the IP camera and its features
Chapter 2, “Getting Started”	Provides instructions for installing and performing the initial setup of the IP camera, accessing and understanding the IP camera user interface, adjusting its back focus, powering the IP camera on and off, resetting the IP camera, and managing the local storage.
Chapter 3, “Configuring and Managing the IP Camera”	Explains how to configure, manage, and administer the IP camera through the web-based configuration pages
Chapter 4, “Viewing Live Video”	Explains how to view live video from the IP camera
Chapter 5, “Troubleshooting”	Provides basic troubleshooting information

Obtaining Documentation, Obtaining Support, and Security Guidelines

For information about obtaining documentation, submitting a service request, and gathering additional information, see the monthly *What’s New in Cisco Product Documentation*, which also lists all new and revised Cisco technical documentation, at:

<http://www.cisco.com/en/US/docs/general/whatsnew/whatsnew.html>

Subscribe to the *What’s New in Cisco Product Documentation* as a Really Simple Syndication (RSS) feed and set content to be delivered directly to your desktop using a reader application. The RSS feeds are a free service and Cisco currently supports RSS version 2.0.



CHAPTER 1

Overview

This chapter provides an overview of the Cisco 4000E Series Video Surveillance High-Definition IP Cameras and their features. These IP cameras include:

- CIVS-IPC-4300E—High-definition digital camera that is suitable for a wide range of video surveillance applications
- CIVS-IPC-4500E—Identical features to the CIVS-IPC-4300E model with the addition of digital signal processor (DSP) capabilities that are used for the Cisco video analytics feature



Note

The CIVS-IPC-4300E model is not designed to be upgraded with a DSP.

This chapter includes these topics:

- [IP Camera Features, page 1-1](#)
- [IP Camera Physical Details, page 1-3](#)
- [DC Auto Iris Lens Connector Pinouts, page 1-6](#)
- [Package Contents, page 1-6](#)

IP Camera Features

The Cisco Video Surveillance IP Camera offers a feature-rich digital camera solution for a video surveillance system. The camera provides high-definition (HD) video and simultaneous H.264 and MJPEG compression, streaming up to 30 frames per second (fps) at 1080p (1920 x 1080) resolution, and 60 fps at 720p (1280 x 720) resolution. Contact closures and two-way audio allow integration with microphones, speakers, and access control systems.

In addition, the IP camera provides networking and security capabilities, including multicast support, hardware-based Advanced Encryption Standard (AES), and hardware-based Data Encryption Standard/Triple Data Encryption Standard (DES/3DES) encryption. The camera can be powered through an external power supply or by integrated Power over Ethernet (PoE).

The IP camera includes the following key features:

- **H.264 and MJPEG compression**—The IP camera can generate H.264 and MJPEG streams simultaneously.
- **Progressive scan video**—The IP camera captures each frame at its entire resolution using progressive scan rather than interlaced video capture, which captures each field of video.
- **Analog video output**—Supports analog video at 720p or lower resolution for installation purposes.

- **Video analytics** (CIVS-IPC-4500E only)—Provides an intuitive interface and tools for video analysis.
- **Medianet**—The IP camera supports the Auto Smartports feature of the Media Services Interface (MSI). MSI enables a camera to participate as an endpoint in the Cisco medianet architecture when connected to a medianet enabled switch.
- **Local Storage**—Supports up to 8 GB of USB flash storage of video data when the camera loses network connectivity.
- **Day/night switch support**—An IR-cut filter provides increased sensitivity in low-light conditions.
- **Two-way audio communication**—Audio can be encoded with the video. With the internal or optional external microphone and optional external speaker, you can communicate with people at the IP camera location while you are in a remote location and viewing images from the IP camera.
- **Multi-protocol support**—Supports these protocols: DHCP, FTP, HTTP, HTTPS, NTP, RTP, RTSP, SMTP, SNMP v2 and v3, SSL/TLS, and TCP/IP.
- **Web-based management**—You perform ongoing administration and management of the IP camera through web-based configuration menus.
- **Motion detection**—The IP camera can detect motion in user-designated fields of view by analyzing changes in pixels and generate an alert if motion is detected.
- **Flexible scheduling**—You can configure the IP camera to respond to events that occur within a designated schedule.
- **Syslog support**—The IP camera can send log data to a Syslog server.
- **IP address filter**—You can designate IP addresses that can access the IP camera and IP addresses that cannot access the IP camera.
- **User-definable HTTP/HTTPS port number**—Allows you to define the port that is used to connect to the camera through the Internet.
- **DHCP support**—The IP camera can automatically obtain its IP addresses in a network in which DHCP is enabled.
- **Network Time Protocol (NTP) support**—Allows the IP camera to calibrate its internal clock with a local or Internet time server.
- **Support for C and CS mount lenses**—The IP camera supports a variety of C and CS mount lenses.
- **PTZ support**—The IP camera supports Pelco D protocol, which enables PTZ functions when used with a supported motorized zoom lens, external pan/tilt mount, and control device.
- **Power options**—The IP camera can be powered with 12 volts DC or 24 volts AC, which is provided through an optional external power adapter, or through PoE (802.3af), which is provided through a supported switch.
- **Camera access control**—You can control access to IP camera configuration windows and live video by configuring various user types and log in credentials.

IP Camera Physical Details

The IP camera includes a reset button, built-in microphone, status LEDs, several ports for connecting external devices, and two threaded mounting holes, one on the bottom and one on the top.

Note

The IP camera casing serves as a heatsink for the internal electronics and may be warm to the touch. This is normal and indicates that the heatsink property of the casing is working as designed.

Figure 1-1 and the table that follows describe the items on the front of the IP camera.

Figure 1-1 Front of IP Camera

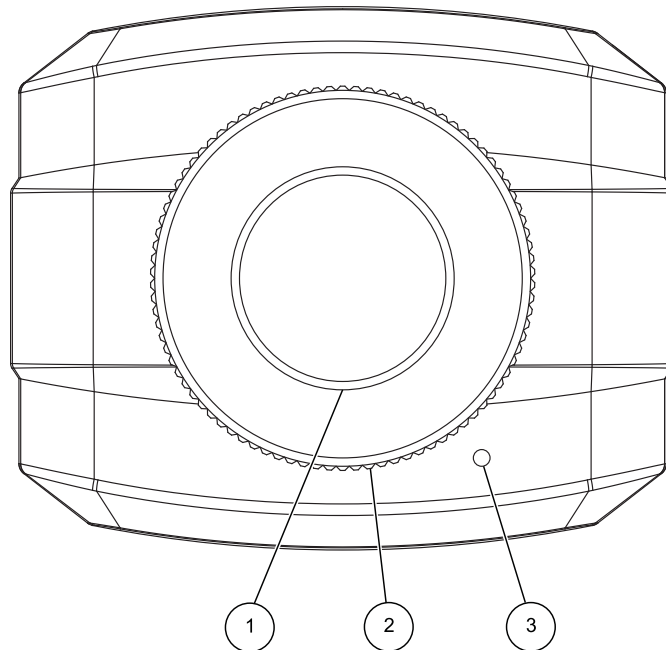

1	Lens opening	The IP camera supports a variety of C and CS mount lenses, which attach here. For best performance, Cisco recommends that you use a DC auto iris lens.
2	Focus ring	Allows you to adjust the back focus of the IP camera. You must loosen the focus ring hex screw on the bottom of the IP camera before you can rotate the focus ring. For instructions, see the “Adjusting Back Focus on the IP Camera” section on page 2-10.
3	Microphone	Captures audio. There also is a connection for an optional external microphone on the rear of the IP camera.

Figure 1-2 and the table that follows describe the items on the rear of the IP camera.

Figure 1-2 Rear of IP Camera

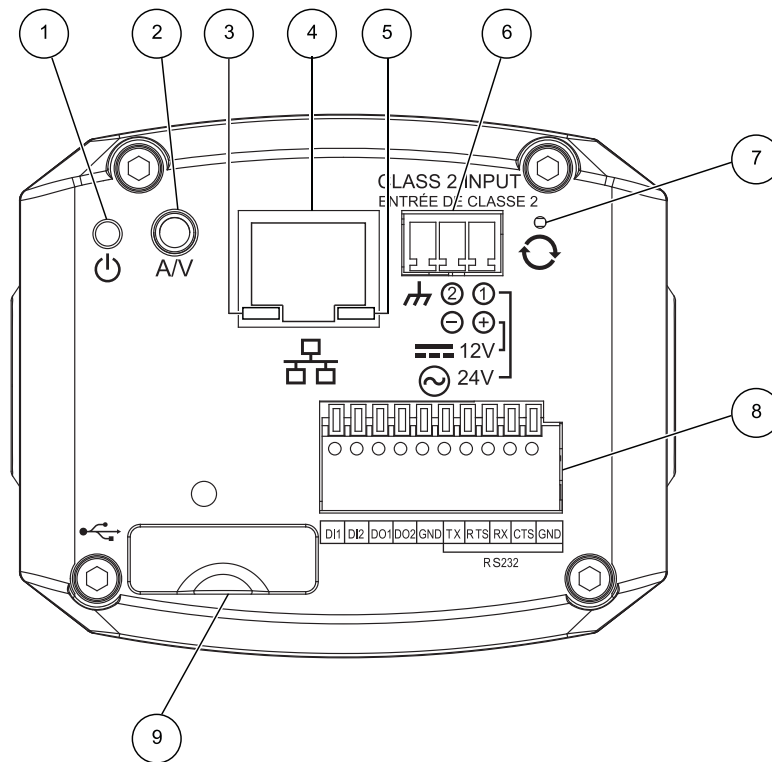

1	Power LED	Lights bright when the IP camera is powering up. Lights dim when the camera is IP operating
2	Analog Audio/Video Port	Allows the connection of an optional Y cable or mini cable with BNC connector. You can connect an optional external speaker or microphone to the Y cable, or an optional video monitor to the mini cable with BNC connector. Both cables are included in the optional audio/video cables accessory kit can be purchased from Cisco (Cisco part number CIVS-IPCA-1021=).
3	PoE LED	Indicates information about PoE as follows: <ul style="list-style-type: none"> • Lit green—PoE connection is detected • Off—PoE connection is not detected
4	LAN port	Accepts a standard LAN cable to connect the IP camera to a 10/100BaseT router or switch.
5	Network Activity LED	Indicates information about the network connections as follows: <ul style="list-style-type: none"> • Lit amber—LAN connection is detected • Off—LAN connection is not detected • Blinking—Data is being transmitted or received via the LAN connection

6	Power input	Provides for the connection of an optional 12 V, 1 amp DC power adapter or 24 VAC power adapter.
		 Caution Use only the Cisco specified power supply adapter.
7	Reset button	Recessed button that reboots the IP camera or resets it to a default state. You can use a pin or paper clip to depress it. It can be used any time that the IP camera is on and can have various effects, as described in the “Resetting the IP Camera” section on page 2-11.
8	GPIO ports	General purpose input/output (GPIO) terminal block that includes 2 input ports (labeled DI1, DI2), 2 output ports (labeled DO1, DO2), a grounding port (labeled GND), and a 5-pin RS-232 port.
9	USB port	Supports up to 8 GB of USB flash storage of video data when the camera loses network connectivity.

Figure 1-3 and the table that follows describe the item on the side of the IP camera.

Figure 1-3 Side of IP Camera

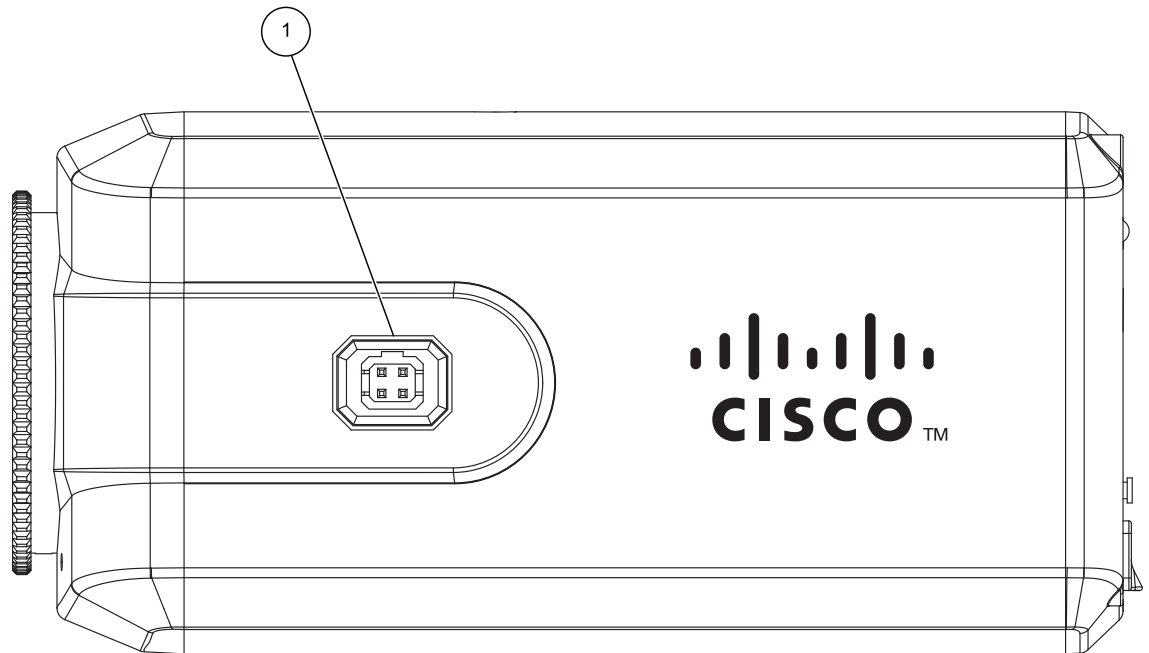

1	DC auto iris lens connector	Connection for cable from DC auto iris lens
---	-----------------------------	---

DC Auto Iris Lens Connector Pinouts

Figure 1-4 describes the pinouts of the DC auto iris lens connector on the IP camera.

Figure 1-4 DC Auto Iris Lens Connector Pinouts

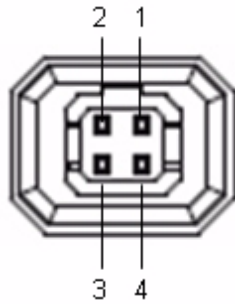

Pin	Function
1	Damp –
2	Damp +
3	Drive +
4	Drive –

Package Contents

The the Cisco Video Surveillance IP Camera package includes these items:

- Camera
- Lens opening dust cap
- USB port cover
- Terminal block for power connection
- C mount lens adaptor ring
- 0.9 mm Allen wrench for unlocking and locking the focus ring
- Quick Start Guide



CHAPTER 2

Getting Started

This chapter provides instructions for installing and performing the initial setup of the Cisco Video Surveillance IP Camera. It also describes how to access the IP camera through a web browser so that you can configure it or view video from it, and how to perform other important tasks.

This chapter includes these topics:

- [Installing the IP Camera, page 2-1](#)
- [Performing the Initial Setup of the IP Camera, page 2-5](#)
- [Accessing the IP Camera, page 2-6](#)
- [Understanding the IP Camera User Interface, page 2-8](#)
- [Adjusting Back Focus on the IP Camera, page 2-10](#)
- [Powering the IP Camera On or Off, page 2-11](#)
- [Resetting the IP Camera, page 2-11](#)
- [Managing the Local Storage, page 2-11](#)

Installing the IP Camera

This section describes how to install the IP camera. Before installing, review these guidelines:

- The IP camera requires a network cable and a connection to a standard 10/100BaseT router or switch. To power the IP camera with Power over Ethernet (PoE), a switch must be 802.3af compliant.
- If you are using the IP camera on a network connection that does not provide PoE, you must use a Cisco 12 VDC power adapter (Cisco part number CIVS-PWRPAC-12V) or a third-party 24 VAC power adapter.
- If you are using an external speaker, microphone, input device, output device, or pan/tilt control device, you must configure additional settings after installing and performing the initial set up of the IP camera before the external device can fully operate. For detailed information about these settings, see [Chapter 3, “Configuring and Managing the IP Camera.”](#)
- If you do not connect an external device (speaker, microphone, input, output, or pan/tilt control) when you perform the following installation procedure, you can install any of these devices later.
- The 4300E and 4500E IP cameras can be placed in a housing that makes the back focus hex screw inaccessible. If you are placing the camera in a housing and adjusting the back focus is required, you must complete the procedure in the [“Adjusting Back Focus on the IP Camera”](#) section on [page 2-10](#) before you install the camera using the procedure in this section.

**Warning**

Installation of the equipment must comply with local and national electrical codes. Statement 1074

**Warning**

The power supply must be placed indoors. Statement 331

**Note**

If you use the IP camera outdoors, place the camera and the power supply in a suitable NEMA enclosure.

**Warning**

This product must be connected to a power-over-ethernet (PoE) IEEE 802.3af compliant power source or an IEC60950 compliant limited power source. Statement 353

**Caution**

Inline power circuits provide current through the communication cable. Use the Cisco provided cable or a minimum 24AWG communication cable.

**Note**

The power adapter that you use with the IP camera must provide power that is within +/-10% of the required power.

**Note**

The equipment is to be connected to a Listed class 2, limited power source.

To install the IP camera, follow the steps in [Table 2-1](#). For illustrations of the connectors and ports that the steps refer to, see the [“IP Camera Physical Details”](#) section on page 1-3.

Table 2-1 *Installing the IP Camera*

	Action	Explanation
Step 1	Attach a lens to the lens opening on the IP camera.	<ul style="list-style-type: none"> If you are using a CS mount lens, screw the lens into the lens opening. The IP camera accepts CS-mount lenses with a lens protrusion of up to 5 mm. If you are using a C mount lens, screw the C mount lens adapter that is supplied with the IP camera into the lens opening, then screw the lens into the adapter. <p>Ensure that the lens is clean because any dirt may degrade the quality of video images.</p> <p>Note Save the lens opening dust cap and replace the dust cap if you remove the lens.</p>
Step 2	If you are using a DC auto iris lens, connect its cable to the DC auto iris lens connector on the IP camera.	For best performance, Cisco recommends that you use a DC auto iris lens.

Table 2-1 Installing the IP Camera (continued)

	Action	Explanation
Step 3	<i>Optional.</i> Use the audio Y cable to connect a speaker, microphone, or both devices to the audio port on the rear of the IP camera.	<p>Each device connects to the audio Y cable through a standard 3.5 mm mini phone jack. A speaker connects to the red jack (speaker out) and a microphone connects to the black jack (mic in). The Y cable that is included in the optional audio/video cables accessory kit can be purchased from Cisco (Cisco part number CIVS-IPCA-1021=).</p> <p>A speaker plays audio that is captured by a microphone that is attached to the PC on which you view video from the camera.</p> <p>Place the external microphone in a location that allows it to capture the audio that you want.</p> <p>Note By default, the IP camera does not transmit or receive audio. To enable and configure audio, see the “Streaming Settings Window” procedure on page 3-3.</p>
Step 4	<i>Optional.</i> Use the mini cable with BNC connector to temporarily attach an NTSC or PAL compliant analog video display device to the analog video out port on the rear of the IP camera for installation purposes.	<p>The analog video device displays video from the IP camera. The display does not include the time stamp or text that are configured for the camera.</p> <p>Connect the monitor BNC connector to the mini cable with BNC adapter, then plug the cable into the analog video out port. The mini cable with BNC adapter is included in the audio/video cables accessory kit, which you can purchase from Cisco (Cisco part number CIVS-IPCA-1021=).</p> <p>Analog video is enabled by default to allow you to adjust the camera field of view during installation. However, it is not supported as a normal camera feed and is automatically disabled when any of the following camera settings are made:</p> <ul style="list-style-type: none"> • Audio is enabled • Resolution is set to 1080p • Framerate is set to 60 fps • Mjpeg is enabled • H.264 and mjpeg are both enabled <p>Note We recommend that you disable analog video after installation. To disable analog video, see the “Streaming Settings Window” procedure on page 3-3.</p>

Table 2-1 Installing the IP Camera (continued)

	Action	Explanation
Step 5	<i>Optional.</i> Use the GPIO ports on the rear of the IP camera to connect external devices that trigger alarms (connect through input ports) or respond to alarms (connect through output ports).	<p>You can connect up to two input devices and two output devices to these ports:</p> <p>DI1—Alarm input 1</p> <p>DI2—Alarm input 2</p> <p>DO1—Alarm output 1</p> <p>DO2—Alarm output 2</p> <p>GND—Ground (for use if needed)</p>
Step 6	<i>Optional.</i> Use the RS-232 ports on the rear of the IP camera to connect a control device (motorized housing) that supports the Pelco D protocol.	A RS-232 cable fits into the ports in one way. Make sure to insert it properly.
Step 7	Connect an STP (shielded twisted pair) Category 5 or higher network cable to the LAN port on the back of the camera and to a 10/100/BaseT router or switch.	If your network provides PoE, the IP camera powers on. Skip to Step 9 .
Step 8	If you are using the IP camera on a network connection that does not provide PoE, connect the optional 12 VDC or 24 VAC power adapter.	<p>First, connect the bare wires at the end of the power adapter to the terminal block that is provided with the IP camera:</p> <ul style="list-style-type: none"> • With the screws on the terminal block facing down, take either of these actions: <ul style="list-style-type: none"> – For a 12 VDC power adapter—Put the positive wire into the slot at the right rear of the terminal block, put the negative wire into the middle slot and put the ground wire in the left slot. (On the Cisco power adapters, the positive wire has a white stripe and the negative wire has no stripe.) – For a 24 VAC power adapter—Put one wire into the into the slot at the right rear of the terminal block and put the other wire into the middle slot. There is polarity, so either wire can go into either slot. • Use a small flat-head screwdriver to tighten the screws on the bottom of the terminal block so that the power adapter wires are attached securely. <p>Note The power adapter may include an attached terminal block that does not fit the IP camera. If so, remove that terminal block and replace it with the one that is provided with the IP camera.</p> <p>Next, plug the terminal block into the power input port on back of the IP camera. The terminal block fits into the input port in one way. Make sure that the tabs on the terminal block face the bottom of the IP camera.</p> <p>Finally, plug the power adapter into an electrical outlet. The IP camera powers up.</p>

Table 2-1 Installing the IP Camera (continued)

	Action	Explanation
Step 9	Check the LEDs on the IP camera.	<ul style="list-style-type: none"> The Ready LED lights brightly while the IP camera starts up. After a few minutes, the Ready LED flashes briefly then dims. The Network LED should be on.
Step 10	Mount the IP camera in the desired location.	Connect the mounting device to the threaded mounting hole on the bottom or top of the IP camera, depending on your installation requirement.

After you install the IP camera, follow the instructions in the [“Performing the Initial Setup of the IP Camera”](#) section on page 2-5 to access and configure the camera.

Performing the Initial Setup of the IP Camera

After you install IP camera as described in the [“Installing the IP Camera”](#) section on page 2-1, or after you perform a factory reset procedure, you must access the IP camera and make initial configuration settings. These settings include administrator and root passwords, and whether the IP camera can be accessed through an HTTP connection in addition to the default HTTPS (HTTP secure) connection.

To make these configuration settings, you connect to the IP camera from any PC that is on the same network as the IP camera. The PC must meet these requirements:

- Operating system—Microsoft Windows XP with Service Pack 2 or higher, or Microsoft Windows 7 Enterprise x64
- Browser—Internet Explorer 8.0 (32-bit only)

In addition, you must know the IP address of the IP camera. By default, when the IP camera powers on, it attempts to obtain an IP address from a DHCP server in your network. If the camera cannot obtain an IP address through DHCP within 90 seconds, it uses a default IP address of 192.168.0.100.

To connect to the IP camera for the first time and make initial configuration settings, perform the following steps. You can change these configuration settings in the future as described in [Chapter 3, “Configuring and Managing the IP Camera.”](#)

Before you Begin

The Microsoft .NET Framework version 2.0 or later must be installed on the PC that you use to connect to the IP camera. You can download the .NET Framework from the Microsoft website.

Procedure

-
- Step 1** Start Internet Explorer, enter **HTTPS://ip_address** in the address field, and press **Enter**.
Replace *ip_address* with the IP address that the IP camera obtained through DHCP or, if the camera was unable to obtain this IP address, enter **192.168.0.100**.
The Account window appears.

- Step 2** In the Set Password and Verify Password fields in the Admin column, enter a password for the IP camera administrator.
- You must enter the same password in both fields. The password is case sensitive and must contain at least eight characters, which can be letters, numbers, and special characters, but no spaces. Special characters are: ! " # \$ % & ' () * + , - . : ; < = > ? @ [\] ^ _ ` { | } ~.
- Step 3** In the Set Password and Verify Password fields in the Root column, enter a password that is used when accessing the IP camera through a Secure Shell (SSH) connection.
- You must enter the same password in both fields. The password is case sensitive and must contain at least eight characters, which can be letters, numbers, and special characters, but no spaces. Special characters are: ! " # \$ % & ' () * + , - . : ; < = > ? @ [\] ^ _ ` { | } ~.
- You use the root password if you need to troubleshoot the IP camera through a SSH connection with the assistance of the Cisco Technical Assistance Center.
- Step 4** In the HTTP area, click the **HTTP** radio button if you want to allow both HTTP and HTTPS connections to the IP camera.
- The default setting is HTTPS, which allows only HTTPS (secure) connections to the IP camera.
- Step 5** Click **Apply**.
- The IP camera reboots.
- Step 6** After the IP camera reboots, start Internet Explorer and, in the Address field, enter the following:
protocol://ip_address
where:
- *protocol* is **HTTPS** or **HTTP**. (You can use HTTP only if you enabled it in [Step 4](#).)
 - *ip_address* is the IP address that you used in [Step 1](#).
- Step 7** If you are prompted to install ActiveX controls, which are required to view video from the IP camera, follow the on-screen prompts to do so.
- The Home window for the IP Camera appears. For information about this window, see the [“Understanding the IP Camera User Interface” procedure on page 2-8](#).

Accessing the IP Camera

After you perform the initial configuration as described in the [“Performing the Initial Setup of the IP Camera” section on page 2-5](#), follow the steps in this section each time that you want to access the IP camera windows to make configuration settings, view live video, or perform other activities.

You access these windows by connecting to the IP camera from any PC that is on the same network as the IP camera and that meets these requirements:

- Operating system—Microsoft Windows XP with Service Pack 2 or higher, or Microsoft Windows 7 Enterprise x64
- Browser—Internet Explorer 8.0 (32-bit only)

You need this information to access the IP camera windows:

- IP address of the IP camera. By default, the IP camera attempts to obtain an IP address from a DHCP server in your network. If the IP camera cannot obtain an IP address through DHCP within 90 seconds of powering up or resetting, it uses the default IP address of 192.168.0.100.

- Port number, if other than the default value. Default port numbers for the IP camera are 443 for HTTPS and 80 for HTTP. The IP camera administrator can configure an HTTPS port and an HTTP port as described in the “[Account Initialization Window](#)” section on page 3-28.
- Your user name and password for the IP camera. The IP camera administrator configures user names and passwords as described in the “[User Settings Window](#)” section on page 3-30.

To access the IP camera windows, perform the following these steps.

Before you Begin

The Microsoft .NET Framework version 2.0 or later must be installed on the PC that you use to connect to the IP camera. You can download the .NET Framework from the Microsoft website.

Procedure

Step 1 Start Internet Explorer and enter the following in the address field:

protocol://ip_address:port_number

where:

- *protocol* is **HTTPS** for a secure connection or **HTTP** for a non-secure connection. You can use HTTP only if you configure the camera to accept non-secure HTTP connections as described in the “[Performing the Initial Setup of the IP Camera](#)” section on page 2-5.
- *ip_address* is the IP address of the IP camera. The default IP address is 192.168.0.100.
- *port_number* is the port number that is used for HTTPS or HTTP connections to the IP camera. You do not need to enter a port number if you are connecting through the default HTTPS port 443 or the default HTTP port 80.

For example,

- Enter the following for a secure connection if the IP address is 192.168.0.100 and the HTTPS port number is 443:

https://192.168.0.100

- Enter the following for a secure connection if the IP address is 203.70.212.52 and the HTTPS port number is 1024:

https://203.70.212.52:1024

- Enter the following for a non-secure connection if the IP address is 203.70.212.52 and the HTTP port number is 80:

http://203.70.212.52

- Enter the following for a non-secure connection if the IP address is 203.70.212.52 and the HTTP port number is 1024:

http://203.70.212.52:1024

Step 2 Enter your IP camera user name and password in the Username and Password fields, then click **Login**.

To log in as the IP camera administrator, enter the user name **admin** (which is case sensitive) and the password that is configured for the administrator. To log in as a user, enter the user name and password that are configured for the user.

The Home window for the IP Camera appears.

Understanding the IP Camera User Interface

After you log in to the IP camera as described in the “[Accessing the IP Camera](#)” section on page 2-6, you can access the IP camera windows and perform a variety of administrative and user procedures.

The links and activities that you can see and access in the IP camera windows depend on your IP camera privilege level. Privilege levels are configured as described in the “[User Settings Window](#)” section on page 3-30 and include the following:

- Administrator—Can access all IP camera windows, features, and functions.
- Viewer—Can access the Camera Video/Control window with limited controls, and can access the **Refresh**, **Logout**, **About**, and **Help** links from that window.

IP Camera Window Links

The IP Camera user interface includes links that you use to access various windows and perform other activities. [Table 2-2](#) describes each link and lists the IP camera privilege level that you must have to access the link.

Table 2-2 *Links in the IP Camera Windows*

Link	Description	Privilege Level
Refresh	Updates the information in the window that is currently displayed.	Administrator User
Home	Displays the Home window.	Administrator
View Video	Displays the Camera Video/Control window. You may be prompted to install ActiveX controls when trying to access this window for the first time. ActiveX controls are required to view video from the IP camera. Follow the on-screen prompts to install ActiveX controls.	Administrator User
Setup	Provides access to the configuration menus for the IP camera.	Administrator
Logout	Logs you out from the IP camera.	Administrator User
About	Displays a pop-up window with model, version, and copyright information for the IP camera.	Administrator User
Help	Displays reference information for the window that is currently displayed.	Administrator User

IP Camera Windows

The IP camera user interface includes these main windows:

- Home window—Displays the information that is described in [Table 2-3](#).
- Setup window—Provides access to the IP camera configuration windows. For detailed information, see [Chapter 3, “Configuring and Managing the IP Camera.”](#)
- Camera Video/Control window—Displays live video from the camera and lets you control a variety of camera and display functions. For detailed information, see [Chapter 4, “Viewing Live Video.”](#)

Table 2-3 Home Window Information

Field	Description
General Information	
ID	Identifier of the IP camera. To configure the ID, see the “Basic Settings Window” section on page 3-18 .
Name	Name of the IP camera. To configure the name, see the “Basic Settings Window” section on page 3-18 .
Current Time	Current date and time of the IP camera. To set the date and time, see the “Time Settings Window” section on page 3-20 .
S/N	Serial number of the IP camera.
Firmware	Version of the firmware that is installed on the IP camera.
Codec	Version of the codec that is running on the IP camera.
Part Number	Cisco manufacturing part number of the IP camera.
Top Assembly Revision	Cisco assembly revision number.
Network Status	
MAC Address	MAC address of the IP camera.
Configuration Type	Method by which the IP camera obtains its IP address. To configure this method, see the “IP Addressing Window” section on page 3-19 .
LAN IP	IP address of the LAN to which the IP camera is connected. To configure this IP address, see the “IP Addressing Window” section on page 3-19 .
Subnet Mask	Subnet mask of the LAN to which the IP camera is connected. To configure the subnet mask, see the “IP Addressing Window” section on page 3-19 .
Gateway Address	IP address of the gateway through which the IP camera is connected. To configure this IP address, see the “IP Addressing Window” section on page 3-19 .
Primary DNS	IP address of the primary DNS server, if configured for the IP camera. To configure a primary DNS server, see the “IP Addressing Window” section on page 3-19 .
Secondary DNS	IP address of the secondary DNS server, if configured for the IP camera. To configure a secondary DNS server, see the “IP Addressing Window” section on page 3-19 .
IO Port Status	
Input Port 1	Current state of input port 1 on the IP camera.
Input Port 2	Current state of input port 2 on the IP camera.

Table 2-3 Home Window Information (continued)

Field	Description
Output Port 1	Current state of output port 1 on the IP camera.
Output Port 2	Current state of output port 2 on the IP camera.
Channel 1 and Channel 2	
User	IP camera user name of each user who is accessing the primary video stream (Channel 1) or the secondary video stream (Channel 2) through a client PC or a third-party device. By default, users appear in order of start time. To display users in ascending order of any information in any corresponding column, click the column heading. Click a column heading again to reverse the display order.
IP Address	IP address of the client device.
Start Time	Time and date that the client accessed the video stream for this session.
Elapsed Time	Length of time that the client has been accessing the video stream.

Adjusting Back Focus on the IP Camera

To obtain the sharpest image from the camera, you may need to adjust its back focus. This adjustment is useful if the focus control on a lens does not allow you to obtain a sharp enough image.



Note

The 4300E and 4500E IP cameras can be placed in a housing that makes the back focus hex screw inaccessible. If you are placing the camera in a housing and adjusting the back focus is required, you must complete the procedure in this section before completing the procedure in the [“Installing the IP Camera” section on page 2-1](#).

To adjust the back focus, perform the following steps while viewing video from the camera. For information about viewing video, see [Chapter 4, “Viewing Live Video.”](#)

Procedure

-
- Step 1** With a lens attached to the IP camera, use the 0.9mm Allen wrench that is supplied with the IP camera to loosen the focus ring hex screw.
- This screw is on the bottom of the camera just behind the focus ring.
- Step 2** Adjust the back focus by aiming the IP camera at an object that is at least 15 feet (4.5 meters) away and rotating the focus ring to obtain a clear image as follows:
- For a variable-focus lens, obtain a sharp picture in both wide-angle and telephoto positions.
 - For a zoom lens, ensure that the object of interest remains in focus throughout the entire zoom range of the lens.
- Step 3** Use the Allen wrench to tighten the focus ring hex screw.
-

Powering the IP Camera On or Off

The IP camera does not include an on/off switch. You power it on or off by connecting it to or disconnecting it from a power source. When you power off the IP camera, configuration settings are retained.

To power on the IP camera, take either of these actions:

- Use an STP (shielded twisted pair) Category 5 or higher network cable to connect the IP camera to a network switch that provides 802.3af compliant PoE
- Use an optional 12 VDC or 24VAC power adapter to connect the IP camera to a wall outlet

To power off the IP camera, take either of these actions:

- If the IP camera is receiving PoE, disconnect the network cable
- If the IP camera is receiving power through the power adapter, unplug the adapter from the wall or disconnect it from the camera

Resetting the IP Camera

You reset the IP camera by pressing the Reset button on the rear of the device (see [Figure 1-3 on page 1-5](#)). There are various reset types, as described in [Table 2-4](#).

You also can also perform these reset operations from the Maintenance Settings window as described in the [“Maintenance Settings Window” section on page 3-31](#).

Table 2-4 *Resetting the IP Camera*

Reset Type	Procedure	Remarks
Reboot.	Press and immediately release the Reset button.	This action is equivalent to powering the IP camera down and then powering it up. Settings that are configured for the IP camera are retained.
Factory reset.	Press and hold the button for at least 15 seconds.	Sets all IP camera options to their default values. After you perform this procedure, follow the steps in the “Performing the Initial Setup of the IP Camera” section on page 2-5 .

Managing the Local Storage

The 4000E Series IP cameras have a USB port that can support an optional USB flash drive (up to 8 GB) for local storage purposes. If local storage is available on an IP camera and the camera loses network connectivity, video data storage switches to the local USB flash drive.

For security purposes, video data stored on the USB flash drive is encrypted. To view the encrypted video, you must decrypt it to H.264 format. Encrypted files cannot be decrypted directly from a USB flash drive on an IP camera; before they can be decrypted, they must either be downloaded to your PC, or the USB flash drive must be moved from the IP camera to your PC.

The USB Download Decryption Utility allows you to manage the USB flash drive and to decrypt the encrypted video data on the flash drive. The utility can be downloaded from Cisco.com and installed on your PC. For more information see the “[Downloading and Installing the USB Download Decryption Utility](#)” section on page 2-12

**Note**

You cannot manage a USB flash drive using the camera firmware or Cisco Video Surveillance Manager (VSM); you must use the USB Download Decryption utility.

This section includes the following local storage management topics:

- [Downloading and Installing the USB Download Decryption Utility, page 2-12](#)
- [Formatting the USB Flash Drive, page 2-12](#)
- [Downloading Encrypted Video Files from the USB Flash Drive, page 2-13](#)
- [Deleting Encrypted Video Files from the USB Flash Drive, page 2-13](#)
- [Decrypting Encrypted Video Files, page 2-14](#)

Downloading and Installing the USB Download Decryption Utility

Procedure

-
- Step 1** Perform the following steps to obtain the USB Download Decryption Utility:
- a. Go to this URL:
<http://www.cisco.com/cisco/software/type.html?mdfid=282582478&flowid=7145>
 - b. Click the **Video Surveillance IP Camera Utility** link.
 - c. Locate and choose the USB download decryption utility file, which is named USBDownloadandDecryptionUtility2.4.0.msi, and click **Download Now**.
 - d. Log in and follow the on-screen prompts to download the file to your PC.
 - e. Close Internet Explorer.
- Step 2** Double-click the **USBDownloadandDecryptionUtility2.4.0.msi** file that you downloaded in Step 1 and follow the on-screen prompts to install the utility on your PC.
- During the installation process, the installer adds the USB Download Decryption Utility icon to your desktop.
-

Formatting the USB Flash Drive

Before you begin

Obtain and insert a USB flash drive into the USB port on the back of the IP camera. USB flash drives up to 8 GB in size are supported.

**Note**

You can purchase an 8 GB USB flash drive for the IP camera from Cisco using part number CIVS-IPC-USB-8GB.

Procedure

- Step 1** Double-click the **USB Download Decryption Utility** icon to open the utility.
- Step 2** Enter the IP address and root password for the IP camera and click **Connect**.
- Step 3** Click **Format USB**.
- Step 4** Click **Yes** twice to verify that you are sure that you want to format the USB flash drive.

The USB flash drive is formatted using a FAT32 partition. If the USB flash drive was previously formatted using a different partition type, such as NTFS, you are prompted to verify that you want to format the USB flash drive using the FAT32 partition.

Downloading Encrypted Video Files from the USB Flash Drive

Procedure

- Step 1** Double-click the **USB Download Decryption Utility** icon to open the utility.
- Step 2** Enter the IP address and root password for the IP camera and click **Connect**.
- When the utility successfully connects to the IP camera, USB flash drive capacity information and a list of the encrypted video files are displayed.
- Step 3** Do one of the following to choose the encrypted files that are to be downloaded to your PC:
- To choose all encrypted video files on the USB flash drive, click **Select all**.
 - To choose some of the encrypted video files on the USB flash drive, click on the ones you want to download from the file list.
- Step 4** Click **Save**.
- The selected files are copied to the specified directory, leaving the original files on the USB flash drive.
-

What to Do Next

To view the encrypted video files that have been downloaded, you must decrypt them. For more information, see the [“Decrypting Encrypted Video Files” section on page 2-14](#)

Deleting Encrypted Video Files from the USB Flash Drive

Procedure

- Step 1** Double-click the **USB Download Decryption Utility** icon to open the utility.
- Step 2** Enter the IP address and root password for the IP camera and click **Connect**.
- When the utility successfully connects to the IP camera, USB flash drive capacity information and a list of the encrypted video files are displayed.

- Step 3** Do one of the following to choose the encrypted files that are to be deleted from the USB flash drive:
- To choose all encrypted video files on the USB flash drive, click **Select all**.
 - To choose some of the encrypted video files on the USB flash drive, click on the ones you want to delete from the file list.

- Step 4** Click **Delete**.

The selected files are deleted from the USB flash drive.

Decrypting Encrypted Video Files

Before you begin

- Download the encrypted video files to your PC, or move the USB flash drive containing the encrypted video files from the IP camera to your PC. For more information about downloading the encrypted video files, see the [“Downloading Encrypted Video Files from the USB Flash Drive” section on page 2-13](#).
- Note the root password of the IP camera that created the encrypted video files.

Procedure

- Step 1** Double-click the **USB Download Decryption Utility** icon to open the utility.

- Step 2** Click the **Decrypt** tab.

- Step 3** Do one of the following to specify the encrypted files that are to be decrypted:

- In the Input files(s) text box, enter the full path and filename for each file to be encrypted. Separate multiple entries with a semicolon.
- Click the **Browse** button for the Input files(s) field, navigate to and choose the files to be encrypted, and click **Open**.

- Step 4** Do one of the following to specify the output directory where the decrypted files are to be saved:

- In the Output directory text box, enter the full path for the output directory.
- Click the **Browse** button for the Output directory field, navigate to and choose the output directory, and click **Open**.

- Step 5** In the password text box, enter the root password for the IP camera that created the encrypted files.

The selected files are decrypted, and for each file, the Status text box indicates whether the decryption process failed or succeeded.



CHAPTER 3

Configuring and Managing the IP Camera

The Cisco Video Surveillance IP Camera provides configuration windows that you use to configure and manage the IP camera. This chapter explains how to access the configuration windows, describes each window, and provides detailed information about the options that are available in each window.

When configuring the IP camera, be aware of these guidelines:

- You must install and set up the Cisco Video Surveillance IP camera as described in [Chapter 2, “Getting Started,”](#) before you can access the configuration menus.
- You must be an IP camera user with administrator privileges to access the configuration windows.
- For security, the configuration windows time out after 30 minutes of no activity. If a time out occurs, you are prompted to log back in by entering your user name and password when you next press a key or click an item. When you log back in, the home window appears.

This chapter includes these topics:

- [Accessing Navigating the Configuration Windows, page 3-1](#)
- [Feature Setup Windows, page 3-2](#)
- [Network Setup Windows, page 3-18](#)
- [Administration Windows, page 3-28](#)
- [Log Windows, page 3-35](#)

Accessing Navigating the Configuration Windows

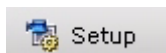

When you are logged in to the IP camera as a user with administrator privileges, you can access the configuration windows at any time by clicking the **Setup** link at the top of an IP camera window. (For information about logging in to the IP camera, see the [“Accessing the IP Camera”](#) section on page 2-6).

When you click **Setup**, a window appears that includes these components:

- Navigation tree—Appears at the left of the window and provides links to each configuration window
- Configuration area—Appears to the right of the navigation tree

The navigation tree always appears. The right area varies depending on the configuration window that you choose from the navigation tree. Use the Navigation Tree to access each configuration window. To do so, click the link or right arrow next to the link for the group of configuration windows that you want. The name of each associated window appears as a link. Then click the link for the desired window.

To collapse a set of links, click the down-arrow next to the top-level link.

The configuration windows are organized as follows:

- Feature Setup
 - Streaming
 - Camera
 - Video Overlay
 - IO Ports
 - Pan/Tilt
 - Event
 - Patrol Sequence
 - Analytics (available for the CIVS-IPC-4500E model only)
- Network Setup
 - Basic
 - IP Addressing
 - Time
 - Discovery
 - SNMP
 - 802.1x
 - IP Filtering
 - QoS
- Administration
 - Initialization
 - Users
 - Maintenance
 - Firmware
 - Device Processes
 - Password Complexity
- Log
 - Setup
 - Local Log

Feature Setup Windows

The Feature Setup windows let you configure a variety of IP camera features and functions. The following sections describe the Feature Setup windows in detail:

- [Streaming Settings Window, page 3-3](#)
- [Camera Settings Window, page 3-6](#)
- [Video Overlay Settings Window, page 3-8](#)
- [IO Ports Settings Window, page 3-9](#)

- [Pan Tilt Settings Window, page 3-10](#)
- [Event Notification Window, page 3-11](#)
- [Patrol Sequence Window, page 3-16](#)
- [Analytics Windows, page 3-18](#)

Streaming Settings Window

The Streaming Settings window provides options for configuring audio and video streams from the IP camera. You can configure settings for the primary and an optional secondary video stream.

Configuring a secondary stream is useful for providing a video stream that is at a lower resolution than the primary stream to third-party devices or software.

The primary stream supports H.264 for video and G.711 A-law, G.711 u-law, and AAC for audio. The secondary stream supports MJPEG for video and does not support audio.

When configuring video streams, be aware of the following guidelines:

- You cannot configure a secondary stream (channel 2) if you configure the resolution for the primary stream (channel 1) to 1920 x 1080
- You cannot configure the resolution for the primary stream to 1920 x 1080 if a secondary stream is enabled
- The resolution of the primary stream must be higher than the resolution of the secondary stream
- You cannot configure a maximum frame rate of 60 for the primary stream if the secondary stream is enabled.
- Multiple secondary frame rates are now supported for MJPEG. [Table 3-1](#) shows the frame rate combinations of primary (H.264) and secondary (MJPEG) streams. If a secondary frame rate that is not shown in this table is selected in Cisco Video Surveillance Manager, the IP camera uses the closest available frame rate.

Table 3-1 Stream Support for Cisco Video Surveillance 4000 Series IP Camera Video

Resolution	Primary (fps)	Secondary (fps)					
1080p	30 or lower	Not supported					
720p or lower	60	Not supported					
	30	30	15	10	5	3	1
	25	25	13	5	1	—	—
	20	20	10	5	1	—	—
	15	15	8	5	3	1	—
	10	10	5	1	—	—	—
	8	8	—	—	—	—	—
	6	6	—	—	—	—	—

To display the Streaming Settings window, access the configuration windows as described in the [“Performing the Initial Setup of the IP Camera”](#) section on page 2-5, click **Feature Setup**, then click **Streaming**.

If you change any options in this window, you must click the **Save Settings** button to save the changes. If you do not click this button, changes are not retained when you exit the window. **Save Settings** appears at the bottom of the window. You may need to scroll down to it.

Table 3-2 describes the options in the Streaming Settings window.

Table 3-2 Streaming Settings Window Options

Option	Description
Current Channel Area	
Channel	Choose the video stream (Channel 1 or Channel 2) to which the configuration settings in the Streaming Settings window apply. Channel 1 is the primary stream and Channel 2 is the secondary stream.
Enable Channel	Check this check box to cause the IP camera to send audio/video data on the selected stream. Note Channel 2 can be enabled only if Channel 1 is set to a video resolution lower than 1920 x 1080.
Channel Name	Name of the video stream. The name can contain up to 16 characters, which can be letters, numbers, and special characters, but no spaces. Special characters are: ! % () + , - : = @ _ ~
Streaming Setup Area	
Note Each video stream uses its own set of streaming options. The settings shown in the Streaming Setup Area apply to the currently selected stream only.	
Enable SRTP	Check this check box to enable Secure Real-time Transport Protocol (SRTP), which provides encryption for the audio/video stream from the IP camera.
RTSP Port	Transmission Control Protocol (TCP) port on which the IP camera receives Real-Time Streaming Protocol (RTSP) commands. You must configure this port if you want to allow third-party devices or software to access video streams from the IP camera. RTSP is a standard for connecting a client to control streaming data over the web. Valid values are 554 and 1024 through 65535. The default port is 554.
Video Source Port	Universal Datagram Protocol (UDP) port on which the IP camera transmits Video Real-Time Transport Protocol (RTP) data. Valid values are even numbers 1024 through 65534. The default port is 1024.
Audio Source Port	UDP port on which the IP camera transmits audio RTP data Valid values even numbers 1024 through 65534. The default value is 1026.
Max RTP Packet Size	Maximum number of bytes per data packets that are sent in each RTP request. Configure a lower number if you are streaming video to a cell phone that requires smaller data packets. Valid values are 400 through 1400. The default value is 1400.

Table 3-2 Streaming Settings Window Options (continued)

Option	Description
Enable Multicast	Check this check box to send video and audio data as a multicast stream. When multicast is enabled, the IP camera sends video and audio to the multicast addresses that you designate. Multicast enables several devices to receive the video signal from the IP camera simultaneously.
Multicast Address	Enter the multicast IP address on which the IP camera sends a multicast audio/video stream.
Multicast Video Port	Enter the port on which the IP camera sends a multicast video stream. Valid values are even numbers 1024 through 65532.
Multicast Audio Port	Enter the port on which the IP camera sends a multicast audio stream. Valid values are even numbers 1024 through 65532.
Time to Live	Enter the number of hops, which specifies the number of network devices that an audio/video stream can pass before arriving at its destination or being dropped. Valid values are 1 through 255.
Video Area	
Note Each video stream uses its own set of video options. The settings shown in the Video Area apply to the currently selected stream only.	
Video Standard	Choose the system for video transmission: NTSC or PAL. The setting that you make affects each channel that is enabled.
Video Codec	<i>Display only:</i> Shows the codec for video transmission: H.264 for the primary stream and MJPEG for the secondary stream.
Video Resolution	Choose the resolution for video transmission. The resolutions in this drop-down list depend on the video standard that you selected. You can also change the resolution for video transmission by using the Video Resolution drop-down list in the Camera Video/Control window, as described in Table 4-1 .
Maximum Frame Rate	Choose the maximum frame rate of the video stream.
Video Quality	Choose an option for the video quality of the video stream from the IP camera: <ul style="list-style-type: none"> • Constant Bit Rate—Available for the primary stream only. Specifies that the video stream is output at or close to the constant bit rate that you choose. The default value is 4 Mbps. A higher bit rate provides better video quality but consumes more bandwidth. • Fixed Quality—Specifies that video is output at a fixed quality, which ranges from Very High to Low. The bit rate may vary to maintain this quality. The default fixed quality is Normal. A higher fixed quality provides better video quality but consumes more bandwidth. <p>You can use these options to help manage bandwidth use in your network. For example, if the IP camera is focused on an area with little movement, such as an emergency exit, you can configure it with a low fixed quality.</p>

Table 3-2 Streaming Settings Window Options (continued)

Option	Description
Analog Video Area	
Note This option applies to the primary stream only.	
Enable Analog Video Port	Check this check box if you if you want the IP camera to enable analog video for installation purposes. To enable analog video, the following settings are required: <ul style="list-style-type: none"> • The primary video stream resolution must be set to 720p or lower. • The primary video stream frame rate must be set to 30 fps or lower. • The secondary video stream must be disabled. • Audio output must be disabled.
Audio Area	
Note These options apply to the primary stream only.	
Enable Audio	Check this check box if you if you want the IP camera to transmit and receive audio.
Audio Codec	Choose the codec (G.711 A-Law, G.711 u-Law, or AAC) for audio that is transmitted from the IP camera. AAC provides highest quality audio and consumes the least bandwidth. The default value is G.711 A-law.
Audio Sampling Rate	<i>Display only.</i> Displays the sampling rate for audio from the IP camera.
Audio Resolution	<i>Display only.</i> Displays the resolution for audio from the IP camera.

Camera Settings Window

The Camera Settings window provides options for selecting a microphone, making certain video adjustments, and configuring the operation of the IP camera day and night filters.

A microphone captures audio at the camera location. This audio is sent to the PC that you use to view video from the IP camera. You can listen to the audio when viewing video in the Camera Video/Control window.

The IP camera day and night filters allow the IP camera to optimize its video image for various lighting conditions. When the IP camera uses its day filter, it is operating in *day mode*. In this mode, the camera displays video images in color. When the IP camera uses its night filter, it is in *night mode*. In this mode, the camera displays video images in black and white.

To display the Camera Settings window, access the configuration windows as described in the [“Performing the Initial Setup of the IP Camera”](#) section on page 2-5, click **Feature Setup**, then click **Camera**.

If you change any options in this window, you must click the **Save Settings** button to save the changes. If you do not click this button, changes are not retained when you exit the window. **Save Settings** appears at the bottom of the window. You may need to scroll down to it.

Table 3-3 describes the options in the Camera Settings window.

Table 3-3 Camera Settings Window Options

Option	Description
Microphone Area	
Microphone Type	<p>Choose the type of microphone that you are using.</p> <ul style="list-style-type: none"> • Internal Microphone—Audio is captured by the internal microphone on the IP camera. • External Microphone—Audio is captured by an optional external microphone, available from third-parties. Choosing this option disables the internal microphone.
Video Adjustments Area	
Auto Iris Mode	<p>Choose whether auto iris mode is enabled or disabled:</p> <ul style="list-style-type: none"> • On—Auto iris mode is enabled. With this setting, the iris opening in the IP camera lens adjusts automatically based on light conditions. This setting is the default and recommended choice. • Off - Auto iris mode is disabled. With this setting, the iris opening in the IP camera lens remains fully open.
Sensitivity	<p>Designates how the iris opening in the IP camera lens adjusts when auto iris mode is enabled. As sensitivity increases, the auto iris closes more to reduce the light level and increase the depth of field in bright environments. However, a high sensitivity may cause the image to oscillate between bright and dim. In this situation, reduce the sensitivity to improve the image quality.</p>
White Balance Mode	<p>Choose one the following white balance modes from the drop-down list:</p> <ul style="list-style-type: none"> • Manual—Choose this option if you want to set the white balance by using the White Balance slider in the Camera Video/Control window as described in Chapter 4, “Viewing Live Video.” • Auto—Suitable for most conditions that do not have special lighting • Indoor (incandescent)—Suitable for indoor conditions • Fluorescent (white light)—Suitable for indoor conditions with fluorescent white lighting • Fluorescent (yellow light)—Suitable for indoor conditions with fluorescent yellow lighting • Outdoor—Suitable for outdoor conditions. <p>The default setting is Auto.</p>
Day Night Filter Area	
Filter Type	<p>Choose the day/night mode for the IP camera:</p> <ul style="list-style-type: none"> • Day—IP camera always remains in day mode. • Night—IP camera always remains in night mode. • Auto—IP camera automatically switches between day and night mode based on the lighting condition threshold that you specify.

Table 3-3 Camera Settings Window Options (continued)

Option	Description
Day to Night Threshold	If the Switch Mode option is set to Auto, choose the value that specifies the relative light threshold at which the IP camera switches from day to night mode. A lower value designates that the IP camera switches from day to night mode in brighter conditions. A higher value designated that the IP camera switches modes in darker conditions. The default value is 10.
Night to Day Threshold	If the Switch Mode option is set to Auto, choose the value that specifies the relative light threshold at which the IP camera switches from night to day mode. A lower value designates that the IP camera switches from night to day mode in darker conditions. A higher value designated that the IP camera switches modes in lighter conditions. The default value is 15.
Enable Night Vision Schedule	Check this check box if you want to configure the times that the camera switches to and from night mode. Enabling this schedule disables the Filter Type option. Note If you configure a schedule, make sure that the time on the IP camera is set correctly.
Start Time	Enter the time, in 24 hour format, that the camera enables its night filter.
End Time	Enter the time, in 24 hour format, that the camera disables its night filter.

Video Overlay Settings Window

The Video Overlay Settings window provides options for configuring overlay information that appears on the video image in the Camera Video/Control window.

To display the Video Overlay Settings window, access the configuration windows as described in the “Performing the Initial Setup of the IP Camera” section on page 2-5, click **Feature Setup**, then click **Video Overlay**.

If you change any options in this window, you must click the **Save Settings** button to save the change. If you do not click this button, changes are not retained when you exit the window. **Save Settings** appears at the bottom of the window. You may need to scroll down to it.

Table 3-4 describes the option in the Video Overlay Settings window.

Table 3-4 Video Overlay Settings Window Options

Option	Description
Text Overlay Area	
Enable Time Stamp	Check this check box to display the time from the internal clock of the IP camera as an overlay on the video image from the IP camera.
Enable Text Display	Check this check box to display the text that you enter in the Display Text field as an overlay on the video image from the IP camera. This option can be useful for identifying this IP camera in an installation with several IP cameras.

Table 3-4 Video Overlay Settings Window Options (continued)

Option	Description
Display Text	If you check the Enable Text Display check box, the text that you enter in this field appears as an overlay on the video image from the IP camera. The text can contain up to 26 characters, which can include letters, numbers, spaces, and these characters: ! \$ % () + , - . / : = @ ^ _ ` { } ~

IO Ports Settings Window

The IO Ports Settings window lets you configure various options for the two input and two output ports on the IP camera. A state change of an input ports triggers a camera to take configured actions. Output ports send signals that can control external devices, such as alarms or door switches.

The IP camera can trigger an action only when the input that is received on an input port comes from a contact that is in a normally closed condition. The camera triggers the action when the contact changes to an open condition.

To display the IO Ports Settings window, access the configuration windows as described in the “Performing the Initial Setup of the IP Camera” section on page 2-5, click **Feature Setup**, then click **IO Ports**.

If you change the option in this window, you must click the **Save Settings** button to save the change. If you do not click this button, changes are not retained when you exit the window. **Save Settings** appears at the bottom of the window. You may need to scroll down to it.

Table 3-5 describes the option in the IO Ports Settings window.

Table 3-5 IO Ports Settings Window Options

Option	Description
Input Ports Area	
Port #	<i>Display only.</i> Indicates input port 1 and input port 2.
Current State	<i>Display only.</i> Indicates the current state (high or low) of the corresponding port.
Event Trigger	Choose the state (Rising or Falling) that triggers designated camera actions. When an input port changes to the configured state, the camera determines that an event has occurred and takes the actions that you have configured.
Output Ports	
Port #	<i>Display only.</i> Indicates output port 1 and output port 2.
Current State	<i>Display only.</i> Indicates the current state (high or low) of the corresponding port.
Default State	Choose the state (low or high) that the corresponding port is set to when the IP camera powers on or resets. The port changes to this state when you click Save Settings . The default setting is High.
Event Action	<i>Display only.</i> Indicates the current state (high or low) that the output port changes to when an event occurs.

Table 3-5 IO Ports Settings Window Options (continued)

Option	Description
Automatic Reset	Check this check box if you want the corresponding output port to go back to its default state after an event occurs.
Duration	If you checked the Automatic Reset check box, enter the amount of time, in milliseconds, that elapses before the port goes back to its default state after an event changes it from the default state.

Pan Tilt Settings Window

The Pan Tilt Settings window provides options for configuring pan and tilt functions for the IP camera. These functions require that the IP camera be installed with a pan/tilt mount that supports the Pelco D protocol.

If you use a pan/tilt mount that requires RS-422 or RS-485 connections, you must connect the mount to the IP camera through a Cisco data converter (part number CIVS-KYBD22232-B).

To display the Pan Tilt Settings window, access the configuration windows as described in the “Performing the Initial Setup of the IP Camera” section on page 2-5, click **Feature Setup**, then click **Pan/Tilt**.

If you change any options in this window, you must click the **Save Settings** button to save the change. If you do not click this button, changes are not retained when you exit the window. **Save Settings** appears at the bottom of the window. You may need to scroll down to it.

Table 3-6 describes the option in the Pan Tilt Settings window.

Table 3-6 Pan Tilt Settings Window Options

Option	Description
Pan/Tilt Area	
Pan and Tilt Enabled	Check this check box to enable pan and tilt operation for the IP camera.
Protocol	<i>Display only.</i> Indicates the protocol for the pan/tilt functionality.
Address	Enter the logical address of the external PTZ device. To determine this address, refer to the documentation for that device.
RS-232 Settings	
Baud Rate	Choose the Baud rate value that is configured on the device that controls the pan and tilt functions of the IP camera. The default setting is 4800 bps.
Data Bits	<i>Display only.</i> Indicates the data bits configuration for the serial port on the IP camera.
Parity	<i>Display only.</i> Indicates the parity configuration for the serial port on the IP camera.
Stop Bits	<i>Display only.</i> Indicates the stop bits configuration for the serial port on the IP camera.

Event Notification Window

The Event Notification window provides options for how the IP camera handles events. An event is any of the following:

- A change of state from low to high or from high to low on an input port of the IP camera. For related information about input ports, see the “[IO Ports Settings Window](#)” section on page 3-9.
- Motion that the IP camera detects. For related information about motion detection, see the “[Motion detection controls](#)” rows in [Table 4-1](#).
- Loss of video signal.

When an event occurs, it triggers the IP camera to take certain configured actions:

- HTTP notification—IP camera sends notification to a remote system via HTTP. This information includes the following:
 - Device ID—ID of the IP camera
 - Device name—Name of the IP camera
 - IP address—IP address of the IP camera
 - MAC address—MAC address of the IP camera
 - Channel ID—Channel identification number (1 for primary stream or 2 for secondary stream)
 - Channel name—Name that is configured for the channel
 - Date and time—Date and time that the event occurred
 - Active post Count—Sequence number of the notification for this event
 - Event type—Type of event
 - Event state—Indicates whether the event is active or inactive at the time that the event was detected for this notification
 - Event description—Description of the event.
 - Input port ID—If the event was triggered by an input port state change, port ID of the port
 - Region index—If the event was triggered by motion detection, identification number of the region in which the IP camera detected motion
 - Sensitivity level—If the event was triggered by motion detection, sensitivity that is configured for the region in which motion was detected
 - Detection threshold—If the event was triggered by motion detection, threshold that is configured for the region in which motion was detected
- Email notification—An event can cause the IP camera to send a notification e-mail message to designated recipients. The message can include a video clip or a snapshot of the activity that triggered the event.

This message includes the same information that is provided with HTTP notification.
- FTP notification—An event can cause the IP camera to upload a video clip or a snapshot of the activity that triggered the event to an FTP server.
- Output port state change—Changes the state of an IP camera output port from low to high or from high to low.
- Syslog server message—Sends a notification message to the designated Syslog server.

The Event Notification window also allows you to designate schedules. If an event takes place within a designated schedule, the IP camera takes the actions that you configure.

To display the Event Notification window, access the configuration windows as described in the “Performing the Initial Setup of the IP Camera” section on page 2-5, click **Feature Setup**, then click **Event**.

If you change any options in this window, you must click the **Save Settings** button to save the change. If you do not click this button, changes are not retained when you exit the window. **Save Settings** appears at the bottom of the window. You may need to scroll down to it.

Table 3-7 describes the option in the Event Notification window.

Table 3-7 Event Notification Window Options

Option	Description
Event Triggering Area	
Triggered by	<p>Check the desired check boxes to designate the events that trigger actions:</p> <p>Input 1—Event is triggered when input port 1 on the IP camera changes state from high to low.</p> <p>Input 2—Event is triggered when input port 2 on the IP camera changes state from high to low.</p> <p>Motion Detection—Event is triggered when the camera detects motion, if motion detection is configured as described the “Motion detection controls” rows in Table 4-1.</p> <p>Video Loss—Event is triggered if the IP camera loses input to its codec sensor module.</p>
Actions	<p>Check the desired check boxes to designate that actions that the IP camera takes when the corresponding trigger occurs.</p> <ul style="list-style-type: none"> • Email—Sends information about the event in an e-mail message to the designated recipient. You design the recipient and configure other e-mail options in other fields in this window. • Output 1—Changes the state of the output 1 port on the IP camera as defined in the Port Settings window. • Output 2—Changes the state of the output 2 port on the IP camera as defined in the Port Settings window. • Syslog—Sends information about the event to a designated Syslog server. • HTTP—Sends information about the event as an HTTP stream to a remote system. • FTP—Uploads a snapshot or video clip of the event to an FTP server.
Interval	<p>Choose the time interval (in minutes) from the drop-down list to wait after an event occurs before detecting the next event.</p>

Table 3-7 Event Notification Window Options (continued)

Option	Description
Event Scheduling Area	
Scheduling Grid	<p>Designate the times at which an event causes the IP camera to take the designed actions. If an event occurs during a time that is not designated, the IP camera does not take any action.</p> <p>Each cell in this grid represents one hour on the corresponding day, starting at 12:00 a.m. (0:00). To designate times, click the desired cells. Selected cells appear shaded.</p> <p>To select all times, click the Set All button.</p> <p>To deselect all times, click the Clear All button.</p> <p>To change the scheduling settings to the last saved configuration, click Undo.</p>
Set All button	Selects all cells in the scheduling grid.
Clear All button	Deselects all cells in the scheduling grid.
Undo All button	Deselects cells in the scheduling grid that you selected since last saving Event Notification window settings.
HTTP Notification Area	
Primary HTTP Server	Identify the primary server to which HTTP messages are sent by choosing IP Address or Hostname from the drop-down list and entering the IP address or host name in the corresponding field.
URL Base	<p>Enter a string to be used as the prefix in the HTTP URL. The HTTP URL is sent in this format:</p> <p><code>http://<IP address>/<URL Base>?<system-provided-name-value-pairs></code></p> <p>where <i>IP address</i> is the IP address of the destination server, <i>URL Base</i> is the string that you enter, and <i>system-provided-name-value-pairs</i> is information about the event.</p>
Port Number	Enter the port number that receives messages on the primary server to which HTTP messages are sent.
User Name	If authentication is required on the primary server to which HTTP messages are sent, enter the user name.
Password	If authentication is required on the primary server to which HTTP messages are sent, enter the password.
HTTP Authentication	If authentication is required on the primary server to which HTTP messages are sent, choose the authentication method from the drop-down list.
Secondary HTTP Server	Identify an optional secondary server to which HTTP messages are sent by choosing IP Address or Hostname from the drop-down list and entering the IP address or host name in the corresponding field.

Table 3-7 Event Notification Window Options (continued)

Option	Description
URL Base	Enter a string to be used as the prefix in the HTTP URL for the secondary server. The HTTP URL is sent in this format: <code>http://<IP address>/<URL Base>?<system-provided-name-value-pairs></code> where <i>IP address</i> is the IP address of the destination server, <i>URL Base</i> is the string that you enter, and <i>system-provided-name-value-pairs</i> is information about the event.
Port Number	Enter the port number that receives messages on the secondary server to which HTTP messages are sent.
User Name	If authentication is required on the secondary server to which HTTP messages are sent, enter the user name.
Password	If authentication is required on the secondary server to which HTTP messages are sent, enter the password.
HTTP Authentication	If authentication is required on the secondary server to which HTTP messages are sent, choose the authentication method from the drop-down list.
Email Notification Area	
Primary SMTP Server	Identify the primary SMTP server that is used for sending e-mail by choosing IP Address or Hostname from the drop-down list and entering the IP address or host name in the corresponding field.
Primary SMTP Port	Enter the port number for the primary SMTP server. The default SMTP port number is 25.
POP Server	Identify the primary POP server that is used for sending e-mail by choosing IP Address or Hostname from the drop-down list and entering the IP address or host name in the corresponding field. This field is dimmed if you do not choose Requires POP Before SMTP in the Authentication field that follows.
Authentication	If the primary SMTP server requires authentication to send e-mail, choose the appropriate authentication type from the drop-down list. The authentication type typically is the same as that for the POP3 server that you use to receive e-mail.
Account Name	If the primary SMTP server requires authentication, enter the account name for the server.
Password	If the primary SMTP server requires authentication, enter the account password for the server.
Secondary SMTP Server	Identify an optional secondary SMTP server that is used for sending e-mail by choosing IP Address or Hostname from the drop-down list and entering the IP address or host name in the corresponding field.
Secondary SMTP Port	Enter the port number for the secondary SMTP server. The default SMTP port number is 25.

Table 3-7 Event Notification Window Options (continued)

Option	Description
POP Server	Identify an optional secondary POP server that is used for sending e-mail by choosing IP Address or Hostname from the drop-down list and entering the IP address or host name in the corresponding field. This field is dimmed if you do not choose Requires POP Before SMTP in the Authentication field that follows.
Authentication	If the secondary SMTP server requires authentication to send e-mail, choose the appropriate authentication type from the drop-down list. The authentication type typically is the same as that for the POP3 server that you use to receive e-mail.
Account Name	If the secondary SMTP server requires authentication, enter the account name for the server.
Password	If the secondary SMTP server requires authentication, enter the account password for the server.
Send To	Enter an e-mail address to which an e-mail message is sent when an event occurs.
Show From Address As	Enter the e-mail address to be shown in the From field for the e-mail message that is sent when an event occurs.
Subject	Enter the text to be shown in the Subject field for the e-mail messages that the IP camera sends when events occur. The subject can contain up to 118 characters, including spaces.
Attach Video Streaming URL Address	Check this check box to include in the e-mail message body the URL from which the recipient can access the live video stream from the camera on which the event was detected.
Attach Snapshot	Check this check box to include with the e-mail message a still picture from the beginning of the event. This snapshot is stored on the IP camera until the message is sent. This functionality is available only when the secondary video stream is enabled.
Attach Video Clip	Check this check box and enter the following values to include with the e-mail message a video clip of the event: <ul style="list-style-type: none"> • Pre-Capture Length—Enter the amount of video (in seconds) before the event to include in the video clip. • Post-Capture Length—Enter the amount of video (in seconds) after the event to include in the video clip. This video clip is stored on the IP camera until the message is sent.
FTP Notification Area	
Primary FTP Server	Identify the primary FTP server to which snapshots or video clips are uploaded by choosing IP Address or Hostname from the drop-down list and entering the IP address or host name in the corresponding field.
Primary FTP Port	Enter the port number that receives messages on the primary FTP server. The default FTP port number is 21.
User Name	Enter the primary FTP server login user name.

Table 3-7 Event Notification Window Options (continued)

Option	Description
Password	Enter the primary FTP server login password.
Enable Passive Mode	Check this check box to enable the passive mode feature of the primary FTP server.
Secondary FTP Server	Identify an optional secondary FTP server to which snapshots or video clips are uploaded by choosing IP Address or Hostname from the drop-down list and entering the IP address or host name in the corresponding field.
Secondary FTP Port	Enter the port number that receives messages on the secondary FTP server. The default FTP port number is 21.
User Name	Enter the secondary FTP server login user name.
Password	Enter the secondary FTP server login password.
Enable Passive Mode	Check this check box to enable the passive mode feature of the secondary FTP server.
Upload Snapshot	Check this check box to upload a snapshot of the activity that triggered the event. This functionality is available only when the secondary video stream is enabled.
Upload Video Clip	Check this check box and enter the following values to upload a video clip of the activity that triggered the event: <ul style="list-style-type: none"> • Pre-Capture Length—Enter the amount of video (in seconds) before the event to include in the video clip. The default pre-capture length is 0 seconds (no pre-capture video). • Post-Capture Length—Enter the amount of video (in seconds) after the event to include in the video clip. The default post-capture length is 5 seconds.

Patrol Sequence Window

The Patrol Sequence window provides options for configuring a patrol sequence for the IP camera. A patrol sequence consists of up to eight steps, each of which causes the camera to move to a designated preset position and remain in the position for a designated time.

When you create a patrol sequence, you define the order of the steps. When the patrol sequence runs, the IP camera goes to the preset position that is defined by the first step, then moves through each preset position in the configured order. It stops at the preset position that is defined by the last step.









Before you can configure a patrol sequence, you must define preset positions as described in the “[Presets controls](#)” rows in [Table 4-1](#). These rows also explain how to start and stop the execution of a patrol sequence.

To display the Patrol Sequence window, access the configuration windows as described in the “[Performing the Initial Setup of the IP Camera](#)” section on [page 2-5](#), click **Feature Setup**, then click **Patrol Sequence**.

If you change any options in this window, you must click the **Save Settings** button to save the change. If you do not click this button, changes are not retained when you exit the window. **Save Settings** appears at the bottom of the window. You may need to scroll down to it.

Table 3-8 describes the option in the Patrol Sequence window.

Table 3-8 Patrol Sequence Window Options

Option	Description
Patrol Sequence Area	
Dwell Time	Choose the length of time in seconds that the camera remains in each preset position when a patrol sequence runs.
Available list Selected list	<p>Configure the order in which the IP camera executes up to 8 steps in a patrol sequence. The Available list displays preset positions that you can use in the patrol sequence. You define these preset positions in the Camera Video/Control window. The Selected list displays the steps in the patrol sequence.</p> <p>When the patrol sequence executes, the IP camera goes to the first preset position in the Selected list, then moves through each position in the list in order. It remains in each position for the time that is defined in the Time Delay field. It stops at the last position in the list.</p> <p>To move preset positions between the Available list and the Selected list, use the following buttons. Buttons become highlighted when they are available.</p> <p> —Move the selected preset position or positions from the Available list to the Selected list. To select a preset position, click it to highlight it. To select more than one preset positions, Ctrl-click each one.</p> <p> —Move the selected preset position or positions from the Selected list to the Available list. To select a preset position, click it to highlight it. To select more than one preset positions, Ctrl-click each one.</p> <p> —Move all preset positions from the Available list to the Selected list.</p> <p> —Move all preset positions from the Selected list to the Available list.</p> <p>To configure the order of steps in the Selected list, use the following buttons. Buttons become highlighted when they are available. To select a preset position, click it to highlight it.</p> <p> —Move the selected preset position to the top of the list.</p> <p> —Move the selected preset position up one position.</p> <p> —Move the selected preset position down one position.</p> <p> —Move the selected preset position to the bottom of the list.</p>

Analytics Windows

The Analytics windows provide access to options for configuring the Cisco video analytics feature.

**Note**

The Analytics window is available only for the CIVS-IPC-4500E model, which has the digital signal processor (DSP) capabilities that are used for the Cisco video analytics feature. The CIVS-IPC-4300E model does not have the DSP capabilities.

**Note**

Even though the Cisco video analytics feature is supported by Cisco Video Surveillance Manager (VSM) 6.3.1 or later, the CIVS-IPC-4500E model is supported only by VSM 6.3.2 or later. For related information, see the current version of *Cisco Video Surveillance Manager User Guide*.

To display the Analytics windows, access the configuration windows as described in the “[Performing the Initial Setup of the IP Camera](#)” section on page 2-5, click **Feature Setup**, then click **Analytics**. A new browser session starts and the Analytics Home window appears. This window displays video from the IP camera and provides access to other windows that contain information and configuration options.

For detailed information about Cisco video analytics and the Analytics windows, see *Cisco Video Analytics User Guide*.

Network Setup Windows

The Network Setup windows let you configure various network-related settings for the IP camera.

The following sections describe the Network Setup windows in detail:

- [Basic Settings Window, page 3-18](#)
- [IP Addressing Window, page 3-19](#)
- [Time Settings Window, page 3-20](#)
- [Discovery Settings Window, page 3-22](#)
- [SNMP Settings Window, page 3-23](#)
- [802.1x Settings Window, page 3-25](#)
- [IP Filter Settings Window, page 3-26](#)
- [QoS Settings Window, page 3-27](#)

Basic Settings Window

The Basic Settings window provides options for identifying the IP camera and controlling basic operations.

To display the Basic Settings window, access the configuration windows as described in the “[Performing the Initial Setup of the IP Camera](#)” section on page 2-5, click **Network Setup**, then click **Basic**.

If you change any options in this window, you must click the **Save Settings** button to save the changes. If you do not click this button, changes are not retained when you exit the window. **Save Settings** appears at the bottom of the window. You may need to scroll down to it.

Table 3-9 describes the options in the Basic Settings window.

Table 3-9 Basic Settings Window Options

Option	Description
Basic Settings Area	
ID	Enter a unique identification for the IP camera, which is used to identify the IP camera to various external applications. The ID can contain up to 64 numbers.
Name	Enter a name for the IP camera. This name appears in the IP camera log file for information that is associated with this IP camera. The name can contain up to 64 characters, which can include letters, numbers, spaces, and these characters: ! \$ % () + , - . / = @ ^ _ ` { } ~. Cisco recommends that you give each IP camera a unique name so that you can identify it easily.
Description	Enter a description of the IP camera. For example, enter the IP camera location, such as “North Entrance Camera 1.” The description can contain up to 128 characters, which can include letters, numbers, spaces, and these characters: ! \$ % () + , - . / = @ ^ _ ` { } ~
Location	Enter the physical location of the IP camera, such as “North Entrance.” The location can contain up to 64 characters, which can include letters, numbers, spaces, and these characters: ! \$ % () + , - . / = @ ^ _ ` { } ~
Contact	Enter system contact information for someone such as the system administrator. For example, enter the e-mail address of the system administrator. The contact can contain up to 64 characters, which can include letters, numbers, spaces, and these characters: ! \$ % () + , - . / = @ ^ _ ` { } ~
Basic Device Operations Area	
Enable Power LED	Check this check box if you want the Power LED on the back of the IP camera to light. If you do not check this check box, this LED does not light.

IP Addressing Window

The IP Addressing window provides options for configuring the IP address of the IP camera.

To display the IP Addressing window, access the configuration windows as described in the “[Performing the Initial Setup of the IP Camera](#)” section on page 2-5, click **Network Setup**, then click **IP Addressing**.

If you change any options in this window, you must click the **Save Settings** button to save the changes. If you do not click this button, changes are not retained when you exit the window. **Save Settings** appears at the bottom of the window. You may need to scroll down to it.

Table 3-10 describes the options in the IP Addressing window.

Table 3-10 IP Addressing Window Options

Option	Description
IP Addressing Area	
IP Version	Choose the IP version from the pull-down list. Currently, only IPv4 is supported.
Configuration Type	Choose the method by which the IP camera obtains its IP address: <ul style="list-style-type: none"> • Dynamic—If your network includes a DHCP server for dynamic allocation of IP addresses, choose this option if you want DHCP to assign an IP address and subnet mask to the IP camera. Depending on your router, the default gateway, primary DNS server, and secondary DNS server may also be assigned. The DHCP server must be configured to allocate static IP addresses based on MAC addresses so that the IP camera always receives the same address. • Static—Choose this option if you want to manually enter an IP address, subnet mask, default gateway, and DNS server IP addresses for the camera.
IP Address	If you configured the IP camera for a static IP address, enter that IP address.
Subnet Mask	If you configured the IP camera for a static IP address, enter the subnet mask for the IP camera. Use the same value that is configured for the PCs on your network.
Gateway Address	If you configured the IP camera for a static IP address, enter the gateway for the IP camera. Use the same value that is configured for the PCs on your network.
Primary DNS	<i>Optional.</i> Enter the IP address of the primary the DNS server that is used in your network. Use the same value that is used for the PCs on your LAN. Typically, your ISP provides this address. This address is required if you use a host name instead of an IP address in any configuration field in the IP camera configuration windows.
Secondary DNS	<i>Optional.</i> Enter the IP address of a secondary (backup) DNS server to use if the primary DNS server is unavailable. Enter the DNS server to be used if the primary DNS server is unavailable. This address is required if you have a secondary DNS server an you use a host name instead of an IP address in any configuration field in the IP camera configuration windows.

Time Settings Window

The Time Settings window provides options for setting and maintaining the time of the IP camera.

To display the Time Settings window, access the configuration windows as described in the [“Performing the Initial Setup of the IP Camera”](#) section on page 2-5, click **Network Setup**, then click **Time**.

If you change any options in this window, you must click the **Save Settings** button to save the changes. If you do not click this button, changes are not retained when you exit the window. **Save Settings** appears at the bottom of the window. You may need to scroll down to it.

Table 3-11 describes the options in the Time Settings window.

Table 3-11 Time Settings Window Options

Option	Description
Set Time Mode Area	
Manually Configure Time	Choose this option if you want to set the time for the IP camera manually.
Use NTP Server to Update Time	Choose this option if you want the IP camera to obtain its time from a network time protocol (NTP) server. If you check this check box, the camera contacts the designated NTP server every 64 seconds and synchronizes its internal clock with the time of that server.
Local Time Area	
Note These options do not apply if you choose the Use NTP Server to Update Time option.	
Set Local Date	Enter a date for the IP camera. The camera is updated with this date when you click Save Settings .
Set Local Time	Enter a time for the IP camera. The camera is updated with this time when you click Save Settings .
Clone PC Time button	Click this button to update the IP camera date and time with the date and time of the PC that you are using.
Time Zone and Daylight Saving Area	
Time Zone	Choose the time zone in which the IP camera is located. The time that appears when you view video from this IP camera reflects this time zone.
Adjust for Daylight Saving Time	Check this check box if you want the time of the IP camera to adjust automatically for daylight saving time.
Edit Default Daylight Saving Configuration for Time Zone	Check this check box if you want the daylight saving time adjustment of the IP camera to be different than the default adjustment for the selected time zone.
Time Offset	If you choose to overwrite the default time zone configuration, enter the number of minutes that the time of the camera adjusts when daylight saving time starts. The camera automatically adjusts its time back by this number of minutes when daylight saving time ends.
Start Date Start Time	If you choose to overwrite the default time zone configuration, enter the day and time (in 24 hour format) that daylight saving time begins. At this day and time, the time of the IP camera adjusts by the value in the Time Offset field.
End Date End Time	If you choose to overwrite the default time zone configuration, enter the day and time (in 24 hour format) that daylight saving time ends. At this day and time, the time of the IP camera adjusts to the non-daylight saving time.

Table 3-11 Time Settings Window Options (continued)

Option	Description
NTP Server Settings Area	
Note These options do not apply if you choose the Manually Configure Time option.	
Primary NTP Server	If you configured the IP camera to obtain its time from an NTP server, identify the primary NTP server by choosing IP Address or Hostname from the drop-down list and entering the IP address or host name in the corresponding field.
Primary NTP Server Port	If you configured the IP camera to obtain its time from an NTP server, enter the primary NTP server port number. Valid values are 123 and 1024 through 65535. The default port is 123.
Secondary NTP Server	If you configured the IP camera to obtain its time from an NTP server, identify the secondary NTP server by choosing IP Address or Hostname from the drop-down list and entering the IP address or host name in the corresponding field.
Secondary NTP Server Port	If you configured the IP camera to obtain its time from an NTP server, enter the optional secondary NTP server port number. Valid values are 123 and 1024 through 65535. The default port is 123.

Discovery Settings Window

The Discovery Settings window provides options for configuring the IP camera to work with Cisco Discovery Protocol or Bonjour. These applications facilitate monitoring and management of your network.

To display the Discovery window, access the configuration windows as described in the [“Performing the Initial Setup of the IP Camera”](#) section on page 2-5, click **Network Setup**, then click **Discovery**.

If you change any options in this window, you must click the **Save Settings** button to save the changes. If you do not click this button, changes are not retained when you exit the window. **Save Settings** appears at the bottom of the window. You may need to scroll down to it.

[Table 3-12](#) describes the options in the Discovery Settings window.

Table 3-12 Discovery Settings Window Options

Option	Description
Cisco Discovery Protocol (CDP) Area	
Enable CDP	Check this check box if CDP is enabled in your network and you want the IP camera to broadcast CDP discovery messages.
Show Neighbors button	Displays a new window with information about CDP-enabled device neighbors in your network.
Bonjour Area	
Enable Bonjour	Check this check box if Bonjour is enabled in your network and you want the IP camera to broadcast Bonjour discovery messages.

SNMP Settings Window

The SNMP Settings window provides options for configuring Simple Network Management Protocol (SNMP) settings for the IP camera. These settings can help you manage complex networks by sending messages to different devices on the network.

To display the SNMP window, access the configuration windows as described in the [“Performing the Initial Setup of the IP Camera” section on page 2-5](#), click **Network Setup**, then click **SNMP**.

If you change any options in this window, you must click the **Save Settings** button to save the changes. If you do not click this button, changes are not retained when you exit the window. **Save Settings** appears at the bottom of the window. You may need to scroll down to it.

[Table 3-13](#) describes the options in the SNMP Settings window.

Table 3-13 *SNMP Settings Window Options*

Option	Description
SNMP v2c Area	
Enable SNMP v2c	Check this check box to enable SNMP v2c.
Read Community String	Enter the SNMP read community string, which identifies the valid read community.
Trap Community String	Enter the SNMP trap community string.
Primary Trap Receiver	Identify the primary trap receiver of the SNMP v2c manager by choosing IP Address or Hostname from the drop-down list and entering the IP address or host name in the corresponding field.
Secondary Trap Receiver	Identify an optional secondary trap receiver of the SNMP v2c manager by choosing IP Address or Hostname from the drop-down list and entering the IP address or host name in the corresponding field.
SNMP v3 Area	
Enable SNMP v3	Check this check box to enable SNMP v3.
Use Default Local Engine ID	Click this radio button if you want to use the default local engine ID for SNMP. The default local engine ID is 8000000903<MAC>, where <MAC> is the MAC address of the IP camera.

Table 3-13 SNMP Settings Window Options (continued)

Option	Description
Manually Configure Local Engine ID	<p>Click this radio button if you want to enter a local engine ID manually, then enter a unique local engine ID.</p> <p>Enter this information in a standard format as defined in RFC3411. Valid formats include (but are not limited to) the following:</p> <ul style="list-style-type: none"> 8000000903<MAC> where <MAC> is the MAC address of the IP camera. For example, if the IP camera MAC address is 00:04:9F:11:22:33, enter 800000090300049F112233. This format is the default. 8000000901<IPv4_address_hex> where <IPv4_address_hex> is the IPv4 address of the IP camera in hexadecimal format. For example, if the IP camera IPv4 address is 192.168.0.100, enter 8000000901C0A80064. 8000000904<text> where <text> is a string of up to 54 characters.
Primary Trap Receiver	Identify the primary trap receiver of the SNMP v3 manager by choosing IP Address or Hostname from the drop-down list and entering the IP address or host name in the corresponding field.
Secondary Trap Receiver	Identify an optional secondary trap receiver of the SNMP v3 manager by choosing IP Address or Hostname from the drop-down list and entering the IP address or host name in the corresponding field.
User #	<i>Display only.</i> Lists the user number of each IP camera user who is configured with the administrator privilege level.
User Name	<i>Display only.</i> Displays the name that is associated with the corresponding user number
Authentication Method	Choose the authentication protocol for SNMP v3 messages that are sent on behalf of the corresponding user.
Authentication Password	<p>Enter a password for the authentication protocol for SNMP v3 messages that are sent on behalf of the corresponding user.</p> <p>This password can contain from 8 to 63 characters, which can be letters, numbers, and special characters, but no spaces. Special characters are: ! \$ () - . @ ^ _ ` { } ~</p>
Privacy Method	<p>Choose DES if you want to use this privacy method for SNMP v3 messages that are sent on behalf of the corresponding user.</p> <p>If you do not want to use a privacy method, choose None.</p>
Privacy Password	<p>If you choose a privacy method, enter a password for SNMP v3 messages that are sent on behalf of the corresponding user.</p> <p>This password can contain from 8 to 63 characters, which can be letters, numbers, and special characters, but no spaces. Special characters are: ! \$ () - . @ ^ _ ` { } ~</p>

802.1x Settings Window

The 802.1x Settings window provides options for configuring 802.1x authentication for the IP camera. These settings require that RADIUS be configured on your network to provide the client authentication.

To display the 802.1x Settings window, access the configuration windows as described in the “Performing the Initial Setup of the IP Camera” section on page 2-5, click **Network Setup**, then click **802.1x (RADIUS)**.

If you change any options in this window, you must click the **Save Settings** button to save the changes. If you do not click this button, changes are not retained when you exit the window. **Save Settings** appears at the bottom of the window. You may need to scroll down to it.

Table 3-14 describes the options in the 802.1x Settings window.

Table 3-14 802.1x Settings Window Options

Option	Description
802.1x Settings Area	
Enable 802.1x	Check this check box to enable 802.1x authentication for the IP camera.
Protocol Type	Choose the protocol for 802.1x authentication. Options are EAP-TLS , EAP-TTLS , EAP-PEAP , and EAP-FAST . The remaining fields in this window change depending on the protocol type that you choose.
EAP-TLS Configuration Options	
Note These options appear if you select the protocol type EAP-TLS .	
User Name	Enter the user name that the IP camera uses to access the RADIUS server.
Device (Client) Certificate	Path and folder where the device certificate for the IP camera is stored. You can click Browse to find this location. After you enter this information, click Upload to upload the certificate to the IP camera.
Password (for Private Key)	If the private key in the device certificate is password protected, enter the password that is required to unlock the private key.
Root CA Certificate	Path and folder where the root certificate that is required for 802.1x authentication is stored. You can click Browse to find this location. After you enter this information, click Upload to upload the certificate to the IP camera.
EAP-TTLS Configuration Options	
Note These options appear if you select the protocol type EAP-TTLS .	
Inner Authentication	Choose an inner authentication method for EAP-TTLS. Options are MS-CHAP , MS-CHAP v2 , PEAP , and EAP-MDS .
User Name	Enter the user name that the IP camera uses to access the RADIUS server.
Password	Enter the password that the IP camera uses to access the RADIUS server.
Anonymous ID	<i>Optional.</i> Unsigned public identifier to be used instead of a user name for logging in to the RADIUS server.
Validate Server Certificate	Check this check box if you want the identity of the RADIUS server to be validated.

Table 3-14 802.1x Settings Window Options (continued)

Option	Description
Root CA Certificate	Path and folder where the root certificate that is required for 802.1x authentication is stored. You can click Browse to find this location. After you enter this information, click Upload to upload the certificate to the IP camera.
EAP-PEAP Configuration Options	
Note These options appear if you select the protocol type EAP-PEAP .	
Inner EAP Protocol	Choose an inner authentication method for EAP-PEAP.
User Name	Enter the user name that the IP camera uses to access the RADIUS server.
Password	Enter the password that the IP camera uses to access the RADIUS server.
Anonymous ID	<i>Optional.</i> Anonymous identifier to be used instead of a user name for logging in to the RADIUS server.
Validate Server Certificate	Check this check box if you want the identity of the RADIUS server to be validated.
Root CA Certificate	Path and folder where the root certificate that is required for 802.1x authentication is stored. You can click Browse to find this location. After you enter this information, click Upload to upload the certificate to the IP camera.
EAP-FAST Configuration Options	
Note These options appear if you select the protocol type EAP-FAST .	
Inner EAP Protocol	Choose an inner authentication method for EAP-FAST.
User Name	Enter the user name that the IP camera uses to access the RADIUS server.
Password	Enter the password that the IP camera uses to access the RADIUS server.
Anonymous ID	<i>Optional.</i> Anonymous identifier to be used instead of a user name for logging in to the RADIUS server.
Allow Automatic PAC Provisioning	Check this check box if you want to allow authentication servers to establish a secure connection with the IP camera so that they can provide the IP camera with new Protected Access Credentials (PACs).
PAC file	Path and folder where the PAC file is stored. You can click Browse to find this location. After you enter this information, click Upload to upload the certificate to the IP camera.

IP Filter Settings Window

The IP Filter Settings window provides options for controlling access to the IP camera by designating up to 10 IP addresses or address ranges that are allowed or denied access to the IP camera.

To display the IP Filtering window, access the configuration windows as described in the [“Performing the Initial Setup of the IP Camera”](#) section on page 2-5, click **Network Setup**, then click **IP Filtering**.

If you change any options in this window, you must click the **Save Settings** button to save the changes. If you do not click this button, changes are not retained when you exit the window. **Save Settings** appears at the bottom of the window. You may need to scroll down to it.

Table 3-15 describes the options in the IP Filter Settings window.

Table 3-15 IP Filter Settings Window Options

Option	Description
IP Filter Area	
Enable IP Filtering	Check this check box to cause the IP camera to allow or deny access to IP addresses as configured in the IP Filtering window.
Filter Entries Area	
#	<i>Display only.</i> Filter number.
Action	Choose an action for the corresponding IP address or address range: <ul style="list-style-type: none"> • Deny—IP address or address range cannot access the IP camera • Allow—IP address or address range can access the IP camera
IP Address/Bit Mask	Enter the IP address and bit mask to which the corresponding action applies. Make these entries in Classless Inter-Domain Routing (CIDR) notation. CIDR is defined in RFC 4632.

QoS Settings Window

The QoS Settings window provides options for configuring quality of service (QoS) settings for audio/video streams.

To display the QoS Settings window, access the configuration windows as described in the “[Performing the Initial Setup of the IP Camera](#)” section on page 2-5, click **Network Setup**, then click **IP Filtering**.

If you change any options in this window, you must click the **Save Settings** button to save the changes. If you do not click this button, changes are not retained when you exit the window. **Save Settings** appears at the bottom of the window. You may need to scroll down to it.

Table 3-16 describes the options in the QoS Settings window.

Table 3-16 QoS Settings Window Options

Option	Description
Class of Service (CoS) Area	
Enable CoS for Video Streaming	Check this check box to enable class of service (CoS) control for video streams. If you enable this option, the IP camera specifies a VLAN tag that appends to an Ethernet MAC frame for video streaming data.
Video Priority	Value from 0 (lowest priority) through 7 (highest priority) that specifies the CoS priority value for steaming video data.
Video VLAN ID	Enter the ID of the video VLAN to which CoS packets are directed.
Enable CoS for Audio Streaming	Check this check box to enable class of service (CoS) control for audio streams.

Table 3-16 QoS Settings Window Options (continued)

Option	Description
Audio Priority	Value from 0 (lowest priority) through 7 (highest priority) that specifies the CoS priority value for steaming audio data.
Audio VLAN ID	Enter the ID of the audio VLAN to which CoS packets are directed.
Differentiated Services (DiffServ) Area	
Enable DiffServ for Video Streaming	Check this check box to enable Differentiated Services (DiffServ) for video streams. If you enable this option, the IP camera specifies the DSCP priority value that appends to an IP header for video streaming packets.
Video DSCP Priority Value	Value from 0 (lowest priority) through 63 (highest priority) that specifies the DSCP priority value for steaming video data.
Enable DiffServ for Audio Streaming	Check this check box to enable Differentiated Services (DiffServ) for audio streams.
Audio DSCP Priority Value	Value from 0 (lowest priority) through 63 (highest priority) that specifies the DSCP priority value for steaming audio data.

Administration Windows

The Administrator windows lets you perform several general administrative operations, including enabling HTTP and HTTPS access to the IP camera, configuring users, resetting or rebooting the IP camera, and updating firmware.

The following sections describe the Administration windows in detail:

- [Account Initialization Window, page 3-28](#)
- [User Settings Window, page 3-30](#)
- [Maintenance Settings Window, page 3-31](#)
- [Firmware Settings Window, page 3-33](#)
- [Device Processes Window, page 3-34](#)
- [Password Complexity Window, page 3-35](#)

Account Initialization Window

The Account Initialization window provides options for configuring passwords for the IP camera default administrator accounts, and for configuring which protocols can be used to access the IP camera.

The IP camera always has an HTTP/HTTPS administrator who can access the IP camera through an HTTP or HTTPS connection. The name of this administrator is **admin**. The password is configurable.

If you want to access the IP camera through SSH, you must configure a password for an SSH administrator. The name of this administrator is **root**. The password is configurable.

To display the Account Initialization window, access the configuration windows as described in the [“Performing the Initial Setup of the IP Camera”](#) section on page 2-5, click **Administration**, then click **Initialization**.

If you change any options in this window, you must click the **Save Settings** button to save the changes. If you do not click this button, changes are not retained when you exit the window. **Save Settings** appears at the bottom of the window. You may need to scroll down to it.

Table 3-17 describes the options in the Account Initialization window.

Table 3-17 Account Initialization Window Options

Option	Description
Administrator Accounts Area	
Protocol	<i>Display only.</i> Indicates the protocol that the corresponding administrator can use to access the IP camera: HTTP/HTTPS or SSH.
User Name	<i>Display only.</i> Indicates the default user name for the corresponding administrator: admin or root
Password	Enter a password for the corresponding administrator. The password is case sensitive and must contain from 8 to 32 characters, which can be letters, numbers, and special characters, but no spaces. Special characters are: ! \$ () - . @ ^ _ ` { } ~
Confirm password	Re-enter the password for the corresponding administrator.
Access Protocols Area	
Enable HTTP	Check this check box if you want to allow HTTP connections to the IP camera.
HTTP Port	Enter the HTTP port that is used to access the IP camera. Valid port numbers are 80 and 1024 through 32767. The default port is 80. If you configure the HTTP port to a value other than 80, you must specify the port number in the URL for the IP camera when you access it through an HTTP connection. For example, if the IP address of the IP camera is 192.168.1.100 and the HTTP port is 1024, enter this URL for the IP camera: http://192.168.1.100:1024.
Enable HTTPS	Check this check box if you want to allow HTTPS connections to the IP camera.
HTTPS Port	Enter the HTTPS port that is used to access the IP camera. Valid port numbers are 443 and 1024 through 65535. The default port is 443. If you configure the HTTPS port to a value other than 443, you must specify the port number in the URL for the IP camera when you access it through an HTTPS connection. For example, if the IP address of the IP camera is 192.168.1.100 and the HTTPS port is 1024, enter this URL for the IP camera: https://192.168.1.100:1024.
Enable Secure Shell (SSH)	Check this check box if you want to allow access to the camera through a SSH connection.
Secure Shell (SSH) Port	Enter the SSH port that is used to access the IP camera. Valid port numbers are 22 and 1024 through 65535. The default port is 22.

User Settings Window

The User Settings window lets you configure the following types of IP camera users:

- Administrator—Can access all IP camera windows, features, and functions.
- Viewer—Can access only the Camera Video/Control window and all features in that window except:
 - Video image controls
 - Set Current Preset as Home button
 - Add Preset Position button
 - Deleted Selected Preset button
 - Pan/tilt speed controls
 - Motion detection controls

There is always at least one user with Administrator privileges configured. The user name of this user is “admin.” You can configure up to four additional users and assign privilege levels to each one.

When you configure users, follow these guidelines:

- After you enter a name, password, and privilege level for a user, click **Add** next to the user information to save your changes.
- To change the password for an existing user, click **Change** next to the user name.
- To remove a user, click **Delete** next to the user. If you delete a user who is logged into the IP camera, the user remains logged in and can continue access the IP camera.
- To change the name of a user, you must delete the user then create a new user.

To display the User Settings window, access the configuration windows as described in the [“Performing the Initial Setup of the IP Camera”](#) section on page 2-5, click **Administration**, then click **Users**.

Table 3-18 describes the options in the User Settings window.

Table 3-18 User Settings Window Options

Option	Description
User List Area	
User Name	Enter a unique name for the user. The user name is case sensitive and can include up to 64 letters, numbers, and special characters, but no spaces. Special characters are: ! % () + , - = @ _ ~ There is always one user named admin (all lower case), which cannot be deleted.
Password	Enter a password for the user. The password is case sensitive and must contain from 8 to 32 characters, which can be letters, numbers, and special characters, but no spaces. Special characters are: ! \$ () - . @ ^ _ ` { } ~
Confirm Password	Re-enter the password for the user.

Table 3-18 *User Settings Window Options (continued)*

Option	Description
Privilege Level	Select the desired privilege level for the user: <ul style="list-style-type: none"> • Administrator—Can access all IP camera windows, features, and functions. • Viewer—Can access the Camera Video/Control window with limited controls, and can access the Refresh, Logout, About, and Help links from that window.
Change button	Click this button to change the password of the corresponding user.
Add button	Click this button to add the corresponding user. That user can then log in to the IP camera.
Delete button	Click this button to remove the corresponding user. This user can no longer log in to the IP camera.

Maintenance Settings Window

The Maintenance Settings window provides options for setting or restarting the IP camera, saving configuration information from the IP camera, and uploading the configuration information to the IP camera.

Saving and uploading configuration is useful for these activities:

- **Configuring multiple IP cameras**—If your network includes several IP cameras that should have similar configurations, you can configure one IP camera, save that configuration, and upload it to other IP cameras. Then, instead of manually configuring all options on each IP camera, you manually configure only the options that are unique, such as the IP address, if not obtained from DHCP.
- **Backing up configuration**—If you save the configuration from the IP camera, you can upload it to the IP camera to restore the configuration if it is lost, or if you can upload it to a replacement IP camera, if needed.

To display the Maintenance Settings window, access the configuration windows as described in the [“Performing the Initial Setup of the IP Camera”](#) section on page 2-5, click **Administration**, then click **Maintenance**.

If you change any options in this window, you must click the **Save Settings** button to save the changes. If you do not click this button, changes are not retained when you exit the window. **Save Settings** appears at the bottom of the window. You may need to scroll down to it.

Table 3-19 describes the options in the Maintenance Settings window.

Table 3-19 Maintenance Settings Window Options

Option	Description
Factory Default Area	
Restore button	<p>Click the Restore button to reset all IP camera settings to their factory default values.</p> <p>To confirm the restore procedure, click OK in the confirmation pop-up window. Otherwise, click Cancel.</p> <p>This action has the same effect as pressing and holding the Reset button on the IP camera for at least 15 seconds. After you perform this procedure, follow the steps in the “Performing the Initial Setup of the IP Camera” section on page 2-5.</p>
Reset button	<p>Click the Reset button to reset all IP camera settings except the static IP address, gateway IP address, and log in credentials (user name and password) to their factory default values.</p> <p>To confirm the restore procedure, click OK in the confirmation pop-up window. Otherwise, click Cancel.</p>
Reboot Area	
Reboot button	<p>Click the Reboot button to reboot the software on IP camera.</p> <p>To confirm the reboot procedure, click OK in the confirmation pop-up window. Otherwise, click Cancel.</p> <p>This action has the same effect as pressing and immediately releasing the Reset button on the IP camera, or powering the IP camera down and then powering it up.</p>
Device Configuration Area	
Export Configuration from Camera	<p>Click the Export button to save the current IP camera configuration information to a binary file.</p> <p>When you click this button, the File Download window appears. Use this window to save the configuration file.</p> <p>You can then load this configuration information to any same-model IP camera in the network. This feature is useful for creating a backup of this configuration and for configuring other IP cameras based on this configuration.</p>

Table 3-19 Maintenance Settings Window Options (continued)

Option	Description
Import configuration to camera	<p>Path and folder where a configuration file is stored. You can click Browse to find this location. After you enter this information, click Import to load the configuration file to the IP camera.</p> <p>After you upload a configuration file to the IP camera, the IP camera restarts automatically.</p> <p>If you upload configuration from another IP camera that is active in your network, make sure to configure this IP camera with a name, description, and unique IP address (if not obtained through DHCP). To change these options, see the “Basic Settings Window” section on page 3-18 and the “IP Addressing Window” section on page 3-19.</p> <p>A configuration file that you upload includes the passwords that are configured for the administrator and for users. If you change any passwords after saving the configuration file, be aware that uploading the file overwrites the new passwords with the saved ones.</p>

Firmware Settings Window

The Firmware Settings window lets you view information about the firmware that is installed on the IP camera and upgrade the firmware.

Before you upgrade firmware, download the firmware file to a PC that is accessible on your network and unzip the file if it is zipped. To download firmware, go to this web page:

http://www.cisco.com/en/US/products/ps6918/Products_Sub_Category_Home.html

After you upgrade firmware, the IP camera restarts automatically. It retains all configuration information.

To display the Firmware Settings window, access the configuration windows as described in the “[Performing the Initial Setup of the IP Camera](#)” section on page 2-5, click **Administration**, then click **Firmware**.

If you change any options in this window, you must click the **Save Settings** button to save the changes. If you do not click this button, changes are not retained when you exit the window. **Save Settings** appears at the bottom of the window. You may need to scroll down to it.

[Table 3-20](#) describes the options in the Firmware Settings window.

Table 3-20 Firmware Settings Window Options

Option	Description
Device Information Area	
IP Address	<i>Display only.</i> IP address of the IP camera
MAC Address	<i>Display only.</i> MAC address of the IP camera.
Device Name	<i>Display only.</i> ID of the IP camera, as configured in the Basic Settings window. For more information, see the “ Basic Settings Window ” section on page 3-18.

Table 3-20 *Firmware Settings Window Options (continued)*

Option	Description
Firmware Maintenance Area	
Firmware Version	Version of the firmware that is installed on the IP camera.
Firmware Released Date	Release date of the current firmware.
Details button	Click this button to display a pop-up window with additional information about the firmware on the IP camera.
Firmware Upgrade	To upgrade the firmware on the IP camera, begin by entering the path and folder where new firmware file for the IP camera is stored. The upgrade file may be stored on another PC. You can click Browse to find this location.
Upgrade button	After entering the path and folder for the firmware file, click this button to load the firmware upgrade on the IP camera. Do not power down the IP camera during the upgrade procedure.

Device Processes Window

The Device Processes window displays the processes that occupy TCP or UDP ports, and lets you stop any of these processes.

Take care when stopping processes because some processes are required for the camera to operate properly. Processes that you stop in this window can restart the next time that you log in to the IP camera. If you delete a required process and the camera stops functioning, exit your web browser and then log back in to the IP camera to restart the process. If the process does not restart, power the IP camera off and then back on.

To display the Device Processes window, access the configuration windows as described in the [“Performing the Initial Setup of the IP Camera”](#) section on page 2-5, click **Administration**, then click **Device Processes**.

To stop any process, click the **Delete** button that appears to the right of the process in the window.

[Table 3-21](#) describes the options in the Product Process window. All options are for display only.

Table 3-21 *Device Process Window Options*

Option	Description
Protocol	Port (tcp or udp) that the process occupies
Local Address	IP address of the device that the process is listening to
Foreign Address	IP address and port number of the client device that is connected for the process
State	State of the process
Program Name	Name of the process

Password Complexity Window

IP camera administrator and user passwords must always meet the requirements that are described in the “[User Settings Window](#)” section on page 3-30. The Password Complexity window provides options for configuring additional requirements for the IP camera passwords.

To display the Password Complexity window, access the configuration windows as described in the “[Performing the Initial Setup of the IP Camera](#)” section on page 2-5, click **Administration**, then click **Password Complexity**.

Table 3-22 describes the options in the Password Complexity window.

Table 3-22 Password Complexity Window Options

Option	Description
Password must contain at least three of the following: lower case letters, upper case letters, digits, and special characters	Password must contain characters from at least 3 of these categories: <ul style="list-style-type: none"> • Lower case letters (a through z) • Upper case letters (A through Z) • Digits (0 through 9) • Special characters: ! " # \$ % & ' () * + , - . : ; < = > ? @ [\] ^ _ ` { } ~
Password cannot include any character that occurs three or more times consecutively	Administrator password cannot include any character that occurs 3 or more times in a row.
Password cannot be a repeat or reverse of the user name	Password cannot be the same as the user name either forward or reversed

Log Windows

The Log windows let you set up and view the IP camera log file, which captures information about the IP camera and its activities.

The IP camera stores the log file in its internal SDRAM. If the SDRAM becomes full, the IP camera begins to overwrite existing information. To avoid losing log information, you can configure the IP camera to send log information to a Syslog server.



Caution

Because the logs are stored in the internal camera SDRAM, all existing logs in the camera will be lost after a camera reboot, power-up, or power-down.

The following sections describe the Log windows in detail:

- [Log Setup Settings Window](#), page 3-36
- [Local Log Window](#), page 3-38

Log Setup Settings Window

The Log Setup Settings window provides options for configuring the log file and an optional syslog server on which to store log files.

To display the Log Setup Settings window, access the configuration windows as described in the “Performing the Initial Setup of the IP Camera” section on page 2-5, click **Log**, then click **Setup**.

If you change any options in this window, you must click the **Save Settings** button to save the changes. If you do not click this button, changes are not retained when you exit the window. **Save Settings** appears at the bottom of the window. You may need to scroll down to it.

Table 3-23 describes the options in the Log Setup Settings window.

Table 3-23 Log Setup Settings Window Options

Option	Description
Local Log Settings Area	
Minimum Log Severity	<p>Choose the minimum severity of messages that the appear in the log file. The system logs all messages of this severity and higher. Message severities, from highest to lowest, are:</p> <ul style="list-style-type: none"> • Emergency—The system is unusable. • Alert—A situation occurred that requires immediate action. • Critical—A situation occurred that requires action soon. • Error—An error occurred, but it does not necessarily affects the ability of the system to function. • Warning—A undesirable condition occurred. • Notice—Notification about a system condition that is not necessarily an error condition. • Informational—Information about a system activity. • Debug—Information about a system activity with detailed technical information. Includes messages of every other severity. <p>The default severity is Informational.</p>
Maximum Log Entries	<p>Maximum number of entries that the log file maintains. When the log file reaches this limit, it begins overwriting entries, starting with the oldest one.</p> <p>The default value is 100.</p>
Syslog Settings Area	
Enable Syslog	<p>Check this check box to send the log information to a designated Syslog server. The selected information also is maintained on the IP camera until it is overwritten.</p> <p>This option is useful for consolidating logs in deployments with several IP cameras and for retaining logs.</p>
Primary Syslog Server	<p>Identify the primary Syslog server by choosing IP Address or Hostname from the drop-down list and entering the IP address or host name in the corresponding field.</p>
Primary Syslog Server Port	<p>Enter the primary Syslog server port number that receives the logs.</p> <p>Valid values are 514 and 1024 through 65535. The default Syslog port is 514.</p>

Table 3-23 Log Setup Settings Window Options (continued)

Option	Description
Facility	Enter the system facility that receives logs on the Syslog server.
Minimum Log Severity	<p>Choose the minimum severity of messages that are sent to the Syslog server. The system sends all messages of this severity and higher. Message severities, from highest to lowest, are:</p> <ul style="list-style-type: none"> • Emergency—The system is unusable. • Alert—A situation occurred that requires immediate action. • Critical—A situation occurred that requires action soon. • Error—An error occurred, but it does not necessarily affects the ability of the system to function. • Warning—A undesirable condition occurred. • Notice—Notification about a system condition that is not an error condition. • Informational—Information about a system activity. • Debug—Information about a system activity with detailed technical information. Includes messages of every other severity. <p>The default severity is Informational.</p>
Secondary Syslog Server	Identify an optional secondary Syslog server by choosing IP Address or Hostname from the drop-down list and entering the IP address or host name in the corresponding field.
Secondary Syslog Server Port	Enter the port number that receives the logs on the secondary Syslog server. Valid values are 514 and 1024 through 65535. The default Syslog port is 514.
Facility	Enter the system facility that receives logs on the Syslog server.
Minimum Log Severity	<p>Choose the minimum severity of messages that are sent to the secondary Syslog server. The system sends all messages of this severity and higher. Message severities, from highest to lowest, are:</p> <ul style="list-style-type: none"> • Emergency—The system is unusable. • Alert—A situation occurred that requires immediate action. • Critical—A situation occurred that requires action soon. • Error—An error occurred, but it does not necessarily affect the ability of the system to function. • Warning—An undesirable condition occurred. • Notice—Notification about a system condition that is not an error condition. • Informational—Information about a system activity. • Debug—Information about a system activity with detailed technical information. Includes messages of every other severity.

Local Log Window

The Local Log window lets you view the log file that is stored on the IP camera.

To display the Local Log window, access the configuration windows as described in the [“Performing the Initial Setup of the IP Camera” section on page 2-5](#), click **Log**, then click **Local Log**.

[Table 3-24](#) describes the options in the Local Log window.

Table 3-24 Local Log Window Options









Option	Description
Log List Area	
Rows per page	Choose the number of log entry rows to display per page and click the Go button to the right of this option to update the display.
Filter	Choose the type of log message to include in the display. To include messages of every severity, choose All .
Since	Choose the time period for which you want to view log messages.
Go button	Update the log display based on the values in the Filter and Since fields.
Severity	An icon in this column indicates the severity of the corresponding log message: <ul style="list-style-type: none">  —Emergency message  —Alert message  —Critical message  —Error message  —Warning message  —Notice message  —Informational message  —Debug message To display log messages in order of severity with the least severity first, click the Severity column heading. Click the heading again to reverse the display order.
Date/Time	Date and time that the logged activity occurred. By default, log messages appear in the order that the activity occurred with the oldest message first. To reverse this display order, click the Date/Time column heading.
Description	Message that describes the logged activity. For detailed information about log messages, see Table 3-25 on page 3-39 .

Table 3-24 Local Log Window Options (continued)





Option	Description
Page controls	<p>Let you move through the log file entries:</p> <p>Page field—Enter a page number and press Enter.</p> <p> —Go to first page</p> <p> —Go to previous page</p> <p> —Go to next page</p> <p> —Go to last page</p>

Table 3-25 describes the messages that can appear in the IP camera log file. When you view the log file, each message includes the date and time that it was logged. In this table:

- Messages appear in alphabetical order
- Angle brackets (<>) indicate items that are replaced by appropriate information when the message appears. *Italic text* describes these items.
- Severity indicates the severity of the message:
 - 0—Emergency (the system is unusable)
 - 1—Alert (a situation occurred that requires immediate action)
 - 2—Critical (a situation occurred that requires action soon)
 - 3—Error (an error occurred, but it does not necessarily affect the ability of the system to function)
 - 4—Warning (an undesirable condition occurred)
 - 5—Notice (notification about a system condition that is not an error condition)
 - 6—Informational (information about a system activity)
 - 7—Debug (information about a system activity with detailed technical information)

Table 3-25 Log Messages

Message Name	Description that Appears in Log File	Explanation	Severity
AUTHENTICATION_FAILED	Access authentication to <web server, streaming server, or SSH server> by user <user> <IP address or hostname> failed.	An attempt to log in or authenticate to the IP camera failed.	3
AUTHENTICATION_FAILED	Access authentication to <server type> server <server IP address or hostname> failed.	The IP camera was unable to access an SNMP, Syslog, DNS, SMTP, HTTP, or 802.1x server.	4
AUTHORIZATION_FAILED	Unauthorized address <IP address or hostname> attempted to access camera.	An attempt was made to access the IP camera by using invalid user credentials for from an IP address that has been configured for no access.	3
CODEC_LOST	Connection to Codec/Sensor module was lost. Internal module is either down or not responding.	The IP camera codec/sensor module is not responding.	4

Table 3-25 Log Messages

Message Name	Description that Appears in Log File	Explanation	Severity
CONFIG_SAVE_FAILED	Saving configuration to user <user> <IP address or hostname> failed.	A user attempt to save the IP camera configuration failed.	3
CONFIG_SAVED	Configuration saved by user <user> <IP address or hostname>.	The IP camera configuration was saved by a user.	5
CONFIG_UPLOAD_FAILED	Uploading configuration failed from user <user> <IP address or hostname>.	A user attempt to import the IP camera configuration failed.	3
CONFIG_UPLOADED	Configuration uploaded from user <user> <IP address or hostname>.	The IP camera configuration was imported by a user.	5
DEFAULTS_FAILED	Restoring factory defaults failed for user <user> <IP address or hostname>.	An attempt to reset the IP camera to its factory default configuration failed.	3
DEFAULTS_RESTORED	Factory defaults restored successfully by user <user> <IP address or hostname>.	The IP camera was reset to its factory default configuration.	5
DEVICE_REBOOT_AUTO	Device rebooted.	The IP camera rebooted automatically.	5
DEVICE_REBOOT_MANUAL	Device was rebooted manually by user <user> <IP address or hostname>.	The IP camera was rebooted by a user.	5
DHCP_LEASE	DHCP lease renewal was successful.	The IP camera renewed its DHCP lease.	6
DSP_ENCODING_HALTED	The Codec/Sensor module's DSP encoding was halted. Either the analog image signal from the sensor has been lost, or an internal encoding error has occurred.	The DSP of the IP camera codec/sensor module DSP stopped encoding. The analog image signal from the sensor may be lost or an internal encoding error may have occurred.	2
EMAIL_TRIGGERED	Event triggered: email sent to <e-mail address>.	An event occurred and e-mail notification of the event was sent.	5
ETH_BER	Bit Error Rate (BER) exceeded specified threshold of <threshold>.	The bit error rate (BER) exceeded the specified threshold.	4
ETH_SIGNAL_DEGRADE	Ethernet signal degrading.	The IP camera detected a degrading Ethernet signal.	4
FRAMES_DROPPED	Output frame rate does not match the camera's configured frame rate.	The IP camera is sending video at a frame rate that does not match the configured frame rate.	3
FW_UPGRADE_FAILED	Upgrading firmware failed from user <user> <IP address or hostname>.	An attempt to upgrade the IP camera firmware failed.	0
FW_UPGRADED	Firmware upgraded successfully from user <user> <IP address or hostname>.	The IP camera firmware was updated.	5
HTTP_TRIGGERED	Event triggered: notification sent to HTTP server <IP address or hostname>.	An event occurred and HTTP notification of the event was sent.	5
INPUT_ONE_CHANGED	Input port one changed to <high/low>.	Input port 1 on the IP camera changed state.	5
INPUT_ONE_RESET	Input port one reset to <high/low>.	Input port 1 on the IP camera reset to its default state.	5

Table 3-25 Log Messages

Message Name	Description that Appears in Log File	Explanation	Severity
INPUT_TWO_CHANGED	Input port two changed to <high/low>.	Input port 1 on the IP camera changed state.	5
INPUT_TWO_RESET	Input port two reset to <high/low>.	Input port 1 on the IP camera reset to its default state.	5
IP_CONFLICT	IP Address conflict for <IP address>.	IP camera experienced an IP address conflict.	4
IR_FILTER_DAY_AUTO	IR filter changed to day automatically.	The IP camera enabled its day filter automatically.	6
IR_FILTER_DAY_MANUAL	IR filter manually changed to day by user <user> <IP address or hostname>.	The IP camera day filter was enabled by a user.	6
IR_FILTER_NIGHT_AUTO	IR filter changed to night automatically.	The IP camera enabled its night filter automatically.	6
IR_FILTER_NIGHT_MANUAL	IR filter changed to night by user <user> <IP address or hostname>.	The IP camera night filter was enabled by a user.	6
LOG_IN	User <user> <IP address or hostname> logged in to <web server or SSH server>.	A user logged in to the IP camera.	5
LOG_OUT	User <user> <IP address or hostname> logged out of <web server or SSH server>.	A user logged out of the IP camera.	5
MOTION_DETECTED	Motion detected in region <region index>.	The IP camera detected motion in its video field.	5
MOTION_STOPPED	Motion in region <region index> stopped.	The IP camera stopped detecting motion in its video field.	5
OUTPUT_ONE_RESET	Output port one reset to <high/low>.	Output port 1 on the IP camera reset to its default state.	5
OUTPUT_ONE_TRIGGERED	Output port one triggered to <high/low>.	Output port 1 on the IP camera changed state.	5
OUTPUT_TWO_RESET	Output port two reset to <high/low>.	Output port 2 on the IP camera reset to its default state.	5
OUTPUT_TWO_TRIGGERED	Output port two triggered to <high/low>.	Output port 2 on the IP camera changed state.	5
PAN	Pan <left/right> by user <user> <IP address or hostname>.	The IP camera was panned by a user.	6
PATROL_START	Patrol started by user <user> <IP address or hostname>.	A patrol sequence was started by a user.	6
PATROL_STOP	Patrol stopped by user <user> <IP address or hostname>.	A patrol sequence was stopped by a user.	6
POWER_SUPPLY_FAILURE	DC power supply failure.	The DC power for the IP camera failed.	2
PTZ_LOST	Connection to PTZ device was lost. Device is either down or not responding.	The pan/tilt device that the IP camera is connected to is not responding.	4

Table 3-25 Log Messages

Message Name	Description that Appears in Log File	Explanation	Severity
SERVER_CONTACTED	Communication established with <server type> server <server or IP address>.	The IP camera established communication with an SNTP, DHCP, Syslog, DNS, SMTP, HTTP, or 802.1x server.	6
SERVER_LOST	Communication lost with <server type> server <server or IP address>.	The IP camera lost communication with an SNTP, DHCP, Syslog, DNS, SMTP, HTTP, or 802.1x server.	4
SERVER_UNREACHABLE	Failed to contact <server type> server <server or IP address>.	The IP camera was unable to contact an SNTP, DHCP, Syslog, DNS, SMTP, HTTP, or 802.1x server or a gateway.	4
START_STREAM	Channel <channel ID> started streaming to user <user> <IP address or hostname>.	The IP camera began streaming video to a user device.	6
STOP_STREAM	Channel <channel ID> stopped streaming to user <user> <IP address or hostname>.	The IP camera stopped streaming video to a user device.	6
TEMP_THRESHOLD_T1	Current temperature, <temperature>, <exceeds/is below> <high temperature/low temperature> threshold.	The internal temperature of the IP camera is lower than 59°F (15°C) or higher than 149°F (65°C).	2
TEMP_THRESHOLD_T2	Current temperature, <temperature>, <exceeds/is below> <high temperature/low temperature> threshold.	The internal temperature of the IP camera is lower than 32°F (0°C) or higher than 176°F (80°C).	4
TEMP_THRESHOLD_T3	Current temperature, <temperature>, <exceeds/is below> <high temperature/low temperature> threshold.	The internal temperature of the IP camera is lower than 5°F (-15°C) or higher than 194°F (90°C).	5
TILT	Tilt <up/down> by user <user> <IP address or hostname>.	The IP camera was tilted by a user.	6
TIME_DST_SWITCH	Time switched to Daylight Savings time with an offset of <offset> minutes.	The IP camera internal clock switched to daylight saving time.	6
TIME_REG_SWITCH	Time switched from Daylight Savings time with an offset of <offset> minutes.	The IP camera internal clock switched to standard time.	6
UNEXPECTED_EXCEPTION	Unexpected exception occurred. Pan <left/right> failed by user <user> <IP address or hostname>.	An attempt by a user to pan the IP camera failed.	1
UNEXPECTED_EXCEPTION	Unexpected exception occurred. Tilt <up/down> failed by user <user> <IP address or hostname>.	An attempt by a user to tilt the IP camera failed.	1
UNEXPECTED_EXCEPTION	Unexpected exception occurred. Patrol failed by user <user> <IP address or hostname>.	An attempt by a user to start a patrol sequence failed.	1
UNEXPECTED_EXCEPTION	Unexpected exception occurred. Could not <read/write> <to/from> repository by user <user> <IP address or hostname>.	IP camera could not read or write information to its internal repository.	2



CHAPTER 4

Viewing Live Video

After you install and set up the Cisco Video Surveillance IP Camera as described in [Chapter 2, “Getting Started,”](#) users can connect to the IP camera through Internet Explorer and access the Camera Video/Control window to view live video from the IP camera.

The Camera Video/Control window also provides for controlling the video display, configuring preset positions, and controlling certain IP camera functions. Available controls depend on the privilege level of the user.

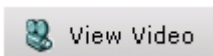

To view live video, log in to the IP camera as described in the [“Accessing the IP Camera”](#) section on [page 2-6](#), then click **View Video** in the IP camera Main window menu bar. The Camera Video/Control window appears. This window displays live video from the camera and lets you control a variety of camera and display functions.

The controls that you see in the Camera Video/Control window depend on your IP camera privilege level and the configurations settings for the IP camera. Users with the Administrator privilege can access all controls. Users with the Viewer privilege do not have access to the following controls:

- Video image controls
- Set Current Preset as Home button
- Add Preset Position button
- Deleted Selected Preset button
- Pan/tilt speed controls
- Motion detection controls

[Table 4-1](#) describes the controls in the Camera Video/Control window.

Table 4-1 Camera Video/Control Window Controls

Control	Description
Video controls	
Video Codec drop-down list 	Choose the codec for video transmission (H.264 or MJPEG). You can choose H.264 only if the primary video stream (channel 1) is enabled. You can choose MJPEG only if the secondary video stream (channel 2) is enabled. For information about enabling and disabling video streams, see the “Streaming Settings Window” section on page 3-3 .

Table 4-1 Camera Video/Control Window Controls (continued)





Control	Description
Video Resolution drop-down list 	<p>Choose the resolution for video transmission. The resolutions in this drop-down list depend on the video standard that you selected.</p> <p>The default value for H.264 is 1920 x 1080. The default value for MJPEG is 704 x 480.</p> <p>You cannot configure a secondary stream if you configure this resolution for 1920 x 1080.</p> <p>Note You can also change the resolution for video transmission by changing the value in the Video Resolution Type field, as described in the “Streaming Settings Window” section on page 3-3.</p>
Right Arrow toggle button 	<p>Click the Right Arrow to display the video image controls. The button changes to the Left Arrow button.</p>
Left Arrow toggle button 	<p>Click the Left Arrow button to hide the video image controls. The button changes to the Right Arrow button.</p>
Video image controls	
Note These controls appear when you click the Right Arrow in the Video Control area.	
White Balance slider 	<p>To control the white balance of the video image, drag the slider, or enter a value from 1 through 100 and press the Enter key. A higher value increases white balance and a lower value decreases white balance.</p> <p>If the White Balance Mode option is not set to Manual as described in the “Camera Settings Window” section on page 3-6, changing the white balance value sets that option to Manual automatically.</p> <p>The default value is 50.</p>
Brightness slider 	<p>To control the brightness of the video image, drag the slider, or enter a value from 1 through 100 and press the Enter key. A higher value increases the brightness and a lower value decreases the brightness. For example, if the IP camera is facing a bright light and the video appears too dark, you can increase the brightness.</p> <p>The default value is 50.</p>
Contrast slider 	<p>To control contrast of the video image, drag the slider, or enter a value from 1 through 100 and press the Enter key. A higher value increases the contrast and a lower value decreases the contrast.</p> <p>The default value is 50.</p>
Sharpness slider 	<p>To control the sharpness of the video from the IP camera, drag the slider, or enter a value from 1 through 100 and press the Enter key. A higher value increases the sharpness and a lower value decreases the sharpness.</p> <p>The default value is 50.</p>

Table 4-1 Camera Video/Control Window Controls (continued)



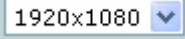

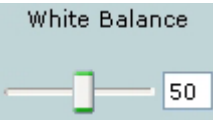
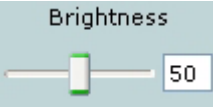
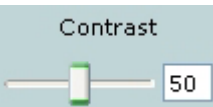

Control	Description
Saturation slider 	<p>To control the saturation of the video from the IP camera, drag the slider, or enter a value from 1 through 100 and press the Enter key. A higher value increases the saturation and a lower value decreases the saturation.</p> <p>High saturation provides a vivid, intense color for a video image. With less saturation, the video image appears more muted and gray.</p> <p>The default value is 50.</p>
Hue slider 	<p>To control the hue of the video from the IP camera, drag the slider, or enter a value from 1 through 100 and press the Enter key. A higher value increases the hue and a lower value decreases the hue.</p> <p>Hue is the relative balance of primary colors.</p> <p>The default value is 50.</p>
Restore button	Resets white balance, brightness, contrast, sharpness, saturation, and hue to their default values.
Image tools	
Hotspot Zoom button 	<p>Click this latch button to enables the digital zoom feature, which provides five-step digital zooming in for the normal (not full screen) video display. Click this button again to disable the digital zoom feature.</p> <p>To perform a digital zoom, engage the Hotspot Zoom button and click the video display. The first five clicks zoom the display. The sixth click returns to unzoomed display.</p>
Hotspot Pan/Tilt button 	<p>Click this latch button to enable the hotspot pan/tilt feature, which lets you pan and tilt the IP camera toward a point that you click in the video display.</p> <p>To perform a hotspot pan/tilt action, engage the Hotspot Pan/Tilt button, then click the video image at the location toward which you want the IP camera to pan and tilt.</p> <p>This feature require that the IP camera be installed with a pan/tilt mount that supports the Pelco D protocol and that pan and tilt functions are enabled. For more information, see the “Pan Tilt Settings Window” section on page 3-10.</p>
Save Snapshot button 	<p>Captures and saves a the current video image as a .gif file or a .jpg file in the location of your choice and with the file name of your choice.</p> <p>When you click this button, the Snapshot window appears. Click Save and follow the on-screen prompts to save the image with the name and in the location that you want.</p>
Flip button 	Rotates the video image by 180 degrees.
Mirror button 	Reverses the video image.

Table 4-1 Camera Video/Control Window Controls (continued)

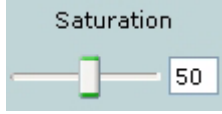
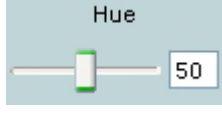





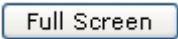

Control	Description
Restore button 	Displays the default video image, which is not rotated and not reversed.
Full Screen button 	Displays the video image in full screen mode. To return to normal display mode, click the full screen image.
Audio controls	
Disable Speaker toggle button 	Click the Disable Speaker button to mute audio that is sent from the IP camera to the PC that you are using. The button changes to the Enable Speaker button. Click the Enable Speaker button to unmute audio. The button changes to the Disable button.
Enable Speaker toggle button 	
Mute Microphone toggle button 	<p>Note If you are simultaneously accessing other IP cameras in different browser sessions on the same PC, clicking this button in one browser session does not mute the audio that the PC sends to the other IP cameras.</p> When you click the Mute Microphone button, it changes to the Unmute Microphone button. Click the Unmute Microphone button to unmute audio that is sent to the IP camera. The button changes to the Mute Microphone button.
Unmute Microphone toggle button 	
Restore button 	Resets audio controls to their default values.
Speaker Volume slider and field 	When the speaker is unmuted, drag this slider to adjust the volume at which your PC speakers play the audio from the IP camera, or enter a value from 0 through 100 and press the Enter key. The default value is 50.
Microphone Sensitivity slider and field 	Drag this slider to adjust the gain of the PC microphone (that is, how sensitive it is to the audio that it picks up and that is sent to the IP camera), or enter a value from 0 through 100 and press the Enter key. The default value is 50.

Table 4-1 Camera Video/Control Window Controls (continued)





Control	Description
Presets controls	
Preset drop-down list	Displays a list of preset positions that you have set for the IP camera. When you choose a preset position from this list, the IP camera moves to that position.
Set Current Preset as Home button 	Click this button to define the current IP pan and tilt camera position as its home position.
Start Auto-Patrol toggle button 	Click the Start Auto-Patrol button to start the patrol sequence. The button changes to the Stop Auto-Patrol button. Click the Stop Auto-Patrol button to stop a sequence that is executing. The button changes to the Start Auto-Patrol button.
Stop Auto-Patrol toggle button 	You define a patrol sequence as described in the “Patrol Sequence Window” section on page 3-16.
Add Preset Position button 	Click this button to add the current IP camera position as a preset position. In the pop-up box, enter a unique name for this position and click Save . The name can contain from 1 to 64 characters, which can be letters, numbers, and special characters, but no spaces. Special characters are: ! % () , - = @ _ ~ You can create up to 8 preset positions.
Delete Selected Preset button 	Click this button then click OK in the confirmation dialog box to delete the preset position that appears in the Preset drop-down list.
Pan/tilt controls	
IP camera control buttons 	<p>To pan the IP camera, use the left or right arrow buttons.</p> <p>To tilt the IP camera, use the up or down arrow buttons.</p> <p>To move the IP camera to its home position, click the Go to Home Position button, which is located in the middle of the group of arrow keys.</p> <p>Pan and tilt functions require that the IP camera be installed with a pan/tilt mount that supports the Pelco D protocol and that pan and tilt functions are enabled. For more information, see the “Pan Tilt Settings Window” section on page 3-10.</p>

Table 4-1 Camera Video/Control Window Controls (continued)





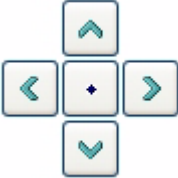

Control	Description
Right Arrow toggle button 	Click the Right Arrow to display the pan/tilt speed controls. The button changes to the Left Arrow button.
Left Arrow toggle button 	Click the Left Arrow button to hide the pan/tilt speed controls. The button changes to the Right Arrow button.
Pan/tilt speed controls	
Note These controls appear when you click the Right Arrow in the Pan/Tilt area.	
Pan Speed slider 	To control the relative speed of panning for the IP camera, drag the slider, or enter a value from 1 through 100 and press the Enter key. A higher value increases pan speed and a lower value decreases pan speed. The default value is 50.
Tilt Speed slider 	To control the relative speed of tilting for the IP camera, drag the slider, or enter a value from 1 through 100 and press the Enter key. A higher value increases tilt speed and a lower value decreases tilt speed. The default value is 50.
Restore button	Click this button to set the pan speed and tilt speed to their default values.
Motion detection	
Note If you configure MJPEG for video control, the motion detection functions are available only if you disable the primary video stream (channel 1). For information about enabling and disabling video streams, see the “Streaming Settings Window” section on page 3-3.	
Up Arrow toggle button 	Click the Up Arrow to display the motion detection controls. The button changes to the Down Arrow button.
Down Arrow toggle button 	Click the Down Arrow button to hide the motion detection controls. The button changes to the Up Arrow button.

Table 4-1 Camera Video/Control Window Controls (continued)

Control	Description
Motion detection controls	
Note These controls appear when you click the Up Arrow in the Motion Detection area and are available only viewing the primary (H.264) stream.	
Enable Motion Detection check box	<p data-bbox="651 436 1521 472">Enables the motion detection feature and displays a grid over the video image.</p> <p data-bbox="651 485 1521 606">When motion detection is enabled, the IP camera monitors activity in the video field areas that you specify. If activity at a defined level occurs in any of these areas, the IP camera generates an alert and takes the actions that are configured as described in the “Event Notification Window” section on page 3-11.</p> <p data-bbox="651 619 1521 716">To designate specific areas that the IP camera monitors for activity, select the areas by clicking each grid cell over the area. A red border indicates a selected area. To deselect an area, click it again.</p> <p data-bbox="651 728 1521 787">You can configure the following levels for areas that the IP camera monitors for activity:</p> <ul data-bbox="651 800 1521 1073" style="list-style-type: none"> <li data-bbox="651 800 1521 942">• Sensitivity—Designates the relative amount of activity that the IP camera must detect in the area before it generates an alert. A lower value means that more, or faster, activity is required to trigger an alert. A higher value means that less, or slower, activity is required. The default value is 50. <li data-bbox="651 955 1521 1073">• Threshold—Designates the percentage of pixels that the IP camera must identify as changed in the area before it generates an alert. The camera detects pixel changes at the defined sensitivity level. The default threshold value is 50. <p data-bbox="651 1085 1521 1306">To configure sensitivity or threshold, right-click a grid cell that has a red border and then drag the Sensitivity and Threshold sliders to the desired values. Alternatively, enter a value from 1 through 100 for an option and press the Enter key. To reset the sensitivity and threshold to their default values of 50, click Restore. These configuration settings affect the cell that you select. If the cell is part of a group of horizontally or vertically (but not diagonally) adjacent cells, the settings affect all cells in the group.</p>

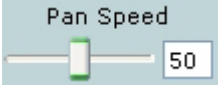
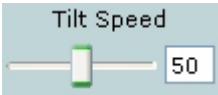
Table 4-1 Camera Video/Control Window Controls (continued)

Control	Description
Full Screen check box	<p>Becomes available when you click check Enable Motion Detection check box. Check the Full Screen check box to cause the IP camera to examine the entire video field for activity.</p> <p>You can configure the following items for this video field:</p> <ul style="list-style-type: none"> • Sensitivity—Designates the relative amount of activity that the IP camera must detect in the area before it generates an alert. A lower value means that more, or faster, activity is required to trigger an alert. A higher value means that less, or slower, activity is required. The default value is 50. • Threshold—Designates the percentage of pixels that the IP camera must identify as changed in the area before it generates an alert. The camera monitors for pixel changes at the defined sensitivity level. The default threshold value is 50. <p>To configure sensitivity or threshold, right-click anywhere in the video field border and then drag the Sensitivity and Threshold sliders to the desired values. Alternatively, enter a value from 1 through 100 for an option and press the Enter key. To reset the sensitivity and threshold to their default values of 50, click Restore.</p>
Restore button	<p>Deselects all areas in the video field that you have selected for motion detection monitoring.</p>
Save Settings button 	<p>Save the current motion detection configuration.</p>



CHAPTER 5

Troubleshooting

This chapter describes some common problems that may be encountered while using the IP camera and provides possible solutions.

Symptom Cannot connect to an IP camera through a web browser.

Possible Cause You are not using a supported PC operating system or web browser, you entered an incorrect IP address for the IP camera, the PC that you are using is not on the same LAN as the IP camera, you are entering an invalid port number for an HTTP or HTTPS connection, or you are trying to access the IP camera from a device with an IP address that is restricted from access.

Recommended Action Make sure that you are using a PC that is running Microsoft Windows XP with Service Pack 2 or higher, or Microsoft Windows 7 Enterprise x64, and that you are using Internet Explorer 8.0 (32-bit only). Make sure that you enter the correct IP address. If you are connecting through a LAN, make sure that the PC is on the same network as the IP camera. If you are connecting through the Internet, make sure to enter the correct port number. Make sure that the device does not have an IP address that is restricted from access (see the [“IP Addressing Window”](#) section on [page 3-19](#).)

Symptom Cannot log in to the IP camera as the administrator.

Possible Cause You are entering the log in credentials incorrectly or have forgotten the administrator password.

Recommended Action The administrator user name is **admin** and the password is the one that you configured. Both credentials are case sensitive, so make sure to enter them exactly as they are configured. If you forget the administrator password, you must perform a factory reset as described in the [“Resetting the IP Camera”](#) procedure on [page 2-11](#), then reconfigure the IP camera. If you take these actions, do not use the Upload option in the Maintenance window to reload a saved configuration file because that process restores the password that you forgot.

Symptom The motion detection feature does not send e-mail alerts.

Possible Cause The e-mail alert feature is not properly configured or the SMTP server that the IP camera uses to send the e-mail may be filtering e-mail to prevent spam from being sent from your server.

Recommended Action Configure e-mail alerts as described in the [“Event Notification Window” section on page 3-11](#). Try using a different SMTP server or contact your ISP to see if SMTP access is being blocked.

Symptom The motion detection feature is configured but video files that are provided in e-mail alerts do not show moving objects.

Possible Cause The motion detection feature does not actually detect motion. It compares frames to see if they are different. Major differences between frames are assumed to be caused by moving objects, but the motion detector can also be triggered by sudden changes in light level or movement of the IP camera itself.

Recommended Action Try to avoid situations with sudden changes in light level and do not bump or move the IP camera. The motion detection feature works best when the IP camera is mounted securely in locations where there is steady. This feature may not work properly if the IP camera is outdoors.

Symptom Blurry images when viewing video.

Possible Cause The lens may be dirty, back focus may not be adjusted properly, or video settings may not be configured for optimal clarity.

Recommended Action Clean the lens on the IP camera. Adjust the back focus as described in the [“Adjusting Back Focus on the IP Camera” section on page 2-10](#). Configure options for video as described in the [“Streaming Settings Window” section on page 3-3](#).



INDEX

Numerics

- 802.1x Settings window
 - options [3-25](#)
 - overview [3-25](#)

A

- About link [2-8](#)
- Account Initialization window
 - options [3-29](#)
 - overview [3-28](#)
- action
 - triggered by event [3-11](#)
- ActiveX controls [2-8](#)
- Administration windows [3-28, 3-35](#)
- Administrator user type [5-1](#)
- Analytics
 - See* Cisco video analytics
- audio
 - controls in Camera Video/Control window [4-4](#)
 - settings [3-6](#)
- Available list [3-17](#)

B

- back focus
 - adjusting [2-10](#)
 - focus ring [2-10](#)
- backing up, configuration of IP camera [3-31](#)
- Basic Settings window
 - options [3-19](#)
 - overview [3-18](#)

- Baud rate, for pan/tilt device [3-10](#)
- bit rate, of video [3-5](#)
- Bonjour, enabling on camera [3-22](#)
- brightness [4-2](#)

C

- camera
 - See* IP camera
- Camera Settings window
 - options [3-7](#)
 - overview [3-6](#)
- Camera Video/Control window
 - accessing [4-1](#)
 - description [2-9](#)
 - displaying [2-8](#)
- CDP (Cisco Discovery Protocol), enabling on camera [3-22](#)
- Cisco video analytics
 - configuration windows [3-18](#)
 - supported camera model [1-1](#)
- Cisco Video Surveillance IP Camera
 - See* IP camera
- C mount lens [1-3, 2-2](#)
- configuration, guidelines [3-1](#)
- configuration windows
 - 802.1x Settings window [3-25](#)
 - accessing [2-6, 3-1](#)
 - Account Initialization window [3-28](#)
 - Administration windows [3-28](#)
 - Analytics window [3-18](#)
 - Basic Settings window [3-18](#)
 - Camera Settings window [3-6](#)

- Device Processes window [3-34](#)
 - Discovery Settings window [3-22](#)
 - Event Notification window [3-11](#)
 - Feature Setup windows [3-2](#)
 - Firmware Settings window [3-33](#)
 - IO Ports Settings window [3-9](#)
 - IP Addressing window [3-19](#)
 - IP Filter Settings window [3-26](#)
 - Local Log window [3-38](#)
 - Log Setup Settings window [3-36](#)
 - Log windows [3-35](#)
 - Maintenance Settings window [3-31](#)
 - Network Setup windows [3-18](#)
 - options [3-2](#)
 - overview [3-1](#)
 - Pan Tilt Settings window [3-10](#)
 - Password Complexity window [3-35](#)
 - Patrol Sequence window [3-16](#)
 - QoS Settings window [3-27](#)
 - SNMP Settings window [3-23](#)
 - Streaming Settings window [3-3](#)
 - time out [3-1](#)
 - Time Settings window [3-20](#)
 - User Settings window [3-30](#)
 - Video Overlay Settings window [3-8](#)
- connecting, to the IP camera
- after the first time [2-6](#)
 - for the first time [2-5](#)
 - PC requirements for [2-5, 2-6](#)
 - secure connection [2-7](#)
- contrast [4-2](#)
- CS mount lens [1-3, 2-2](#)
-
- D**
- data bits, for pan/tilt device [3-10](#)
- date and time
- configuring manually [3-21](#)
 - updating through NTP server [3-21](#)
- day
- filter [3-6](#)
 - mode [3-6](#)
- daylight saving time, adjustment for [3-21](#)
- DC auto iris lens
- connecting [1-3](#)
 - connector pinouts [1-6](#)
- decrypting video files [2-14](#)
- Device Processes window
- options [3-34](#)
 - overview [3-34](#)
- DHCP, obtaining IP address through [2-5, 3-20](#)
- Differentiated Services (DiffServ) [3-28](#)
- Discovery Settings window
- options [3-22](#)
 - overview [3-22](#)
- DNS server
- primary [3-20](#)
 - secondary [3-20](#)
- download decryption utility [2-12](#)
- dual streaming [3-3](#)
- dwell time [3-17](#)
-
- E**
- e-mail notification
- configuring [3-13, 3-14](#)
 - From field [3-15](#)
 - recipients [3-15](#)
- event
- actions
 - email notification [3-11](#)
 - FTP notification [3-11](#)
 - HTTP notification [3-11](#)
 - output port state change [3-11](#)
 - syslog server message [3-11](#)
 - overview [3-11](#)
 - trigger types [3-12](#)
- Event Notification window

options [3-12](#)
 overview [3-11](#)

F

factory default configurations, resetting [3-32](#)
 factory default configurations, restoring [3-32](#)
 factory reset [2-11](#)
 Feature Setup windows [3-2](#)
 firmware
 upgrading [3-33, 3-34](#)
 version in IP camera [3-34](#)
 Firmware Settings window
 options [3-33](#)
 overview [3-33](#)
 flash drive
 deleting files from [2-13](#)
 downloading files from [2-13](#)
 formatting [2-12](#)
 focus, back focus [2-10](#)
 formatting USB flash drive [2-12](#)
 FTP notification
 configuring [3-15](#)

G

gateway, for IP camera [3-20](#)
 General purpose input/output (GPIO) port [1-5](#)

H

help, for IP camera windows [2-8](#)
 home position, moving IP camera to [4-5](#)
 Home window
 accessing [2-6](#)
 description [2-6, 2-7, 2-9](#)
 displaying [2-8](#)
 HTTP

accessing camera through [2-7](#)
 allowing access through [2-6, 3-29](#)
 default port [3-29](#)
 port [3-29](#)

HTTPS

accessing camera through [2-7](#)
 allowing access through [3-29](#)
 default port [3-29](#)
 port [3-29](#)
 hue [4-3](#)

I

input device, connecting [2-4](#)
 input ports
 connecting devices to [2-4](#)
 on IP camera [1-5](#)
 state change [3-11](#)
 installing
 IP camera [2-1](#)
 speaker [2-3](#)
 IO Ports Settings window
 options [3-9](#)
 overview [3-9](#)
 IP address
 controlling access by [3-26](#)
 default for IP camera [2-5, 2-6, 2-7](#)
 fixed [3-20](#)
 obtaining from DCHP server [2-5](#)
 obtaining through DHCP [3-20](#)
 static [3-20](#)
 IP Addressing window
 options [3-20](#)
 overview [3-19](#)
 IP camera
 accessing through a web browser [2-5, 2-6](#)
 back focus of [2-10](#)
 connecting to after the first time [2-6](#)
 connecting to for the first time [2-5](#)

- controlling access to [3-26](#)
 - day mode [3-6](#)
 - DC auto iris lens connector pinouts [1-6](#)
 - description [1-3](#)
 - focus [2-10](#)
 - General purpose input/output (GPIO) port [1-5](#)
 - installation [2-1](#)
 - LAN port on [1-4](#)
 - lens [1-3, 2-2](#)
 - local storage, managing [2-11](#)
 - logging in to [2-7](#)
 - logging out of [2-8](#)
 - MAC address [3-33](#)
 - mounting [2-5](#)
 - name [3-19](#)
 - night mode [3-6](#)
 - overview [1-1](#)
 - package contents [1-6](#)
 - panning [4-3, 4-5](#)
 - power connection [1-5](#)
 - powering off [2-11](#)
 - powering on [2-11](#)
 - rebooting [3-32](#)
 - resetting [1-5](#)
 - restarting [3-32](#)
 - restoring factory default configurations [3-32](#)
 - tilting [4-3, 4-5](#)
 - time zone [3-21](#)
 - troubleshooting [5-1](#)
 - windows [2-6, 2-9](#)
- IP Filter Settings window
- options [3-27](#)
 - overview [3-26](#)
-
- L**
- LAN port [1-4](#)
- LED
- Network Activity [1-4](#)
- PoE [1-4](#)
- power [1-4](#)
- lens
- attaching to IP camera [2-2](#)
 - C mount [2-2](#)
 - CS mount [2-2](#)
 - DC auto iris [1-3, 2-2](#)
 - for IP camera [1-3](#)
 - type [1-3](#)
- live video
- viewing
 - through home window [4-1](#)
 - through third-party device or software [4-1](#)
 - See also* video
- Local Log window
- options [3-38](#)
 - overview [3-38](#)
- local storage
- decrypting video files [2-14](#)
 - managing [2-11](#)
 - USB download decryption utility [2-12](#)
 - USB flash drive
 - deleting files from [2-13](#)
 - downloading files from [2-13](#)
 - formatting [2-12](#)
- log file
- sending to Syslog server [3-36](#)
 - storage of [3-35](#)
 - viewing [3-38](#)
- log in, to IP camera [2-7](#)
- log out, of IP camera [2-8](#)
- Log Setup Settings window
- options [3-36](#)
 - overview [3-36](#)
-
- M**
- MAC address, of IP camera [3-33](#)
- Maintenance Settings window

- options [3-32](#)
- overview [3-31](#)
- microphone
 - external [3-7](#)
 - internal [1-3, 3-7](#)
 - muting PC [4-4](#)
 - on camera [1-3](#)
 - PC [4-4](#)
 - sensitivity [4-4](#)
 - use [3-6](#)
- motion detection
 - accessing controls [4-6](#)
 - enabling [4-7](#)
 - sensitivity [4-7, 4-8](#)
 - threshold [4-7, 4-8](#)
- Motion detection controls [4-7](#)
- mounting, IP camera [2-5](#)
- multicast
 - address [3-5](#)
 - enabling [3-5](#)
 - port [3-5](#)
- muting
 - PC microphone [4-4](#)
 - PC speaker [4-4](#)

N

- name, of IP camera [3-19, 3-33](#)
- network, activity [1-4](#)
- Network Activity LED [1-4](#)
- Network Setup windows [3-18](#)
- night
 - filter [3-6](#)
 - mode [3-6](#)

O

- output device, connecting [2-4](#)

- output ports
 - connecting devices to [2-4](#)
 - on IP camera [1-5](#)
 - power on state [3-9](#)

P

- package contents [1-6](#)
- pan, tilt, zoom
 - See* PTZ
- panning [4-3, 4-5](#)
- Pan Tilt Settings window
 - options [3-10](#)
 - overview [3-10](#)
- parity, for pan/tilt device [3-10](#)
- password
 - complexity [3-35](#)
 - configuring requirements for [3-35](#)
 - for primary SMTP server [3-14](#)
 - for secondary SMTP server [3-15](#)
 - for user [3-30](#)
 - hardening [3-35](#)
 - recovering [5-1](#)
 - requirements for [2-6, 3-30](#)
- Password Complexity window
 - options [3-35](#)
 - overview [3-35](#)
- patrol sequence
 - dwelt time [3-17](#)
 - maximum number of steps [3-16](#)
 - overview [3-16](#)
 - Selected list [3-17](#)
 - steps [3-17](#)
- Patrol Sequence window
 - options [3-17](#)
 - overview [3-16](#)
- pinouts, for DC auto iris lens connector [1-6](#)
- port number [2-7](#)
- power

- port for power adapter [1-5](#)
- powering off the IP camera [2-11](#)
- powering on the IP camera [2-11](#)
- Power over Ethernet (PoE) [2-1](#)
- terminal block [2-4](#)

power adapter

- connecting [2-4](#)
- supported [2-1](#)

Power over Ethernet (PoE) [1-4, 2-1](#)

processes

- descriptions [3-34](#)
- stopping [3-34](#)

Q

QoS Settings window

- options [3-27](#)
- overview [3-27](#)

quality of service [3-27](#)

R

rebooting, IP camera [2-11, 3-32](#)

Refresh link [2-8](#)

reset

- factory default values [2-11](#)
- reboot [2-11](#)

Reset button [1-5](#)

resetting, factory default configurations [3-32](#)

resetting the IP camera [1-5](#)

restarting, IP camera [3-32](#)

restoring, factory default configurations [3-32](#)

RS-232 ports, connecting devices to [2-4](#)

S

saturation [4-3](#)

secure connection [2-7](#)

security

- controlling processes [3-34](#)
- password hardening [3-35](#)
- stopping processes [3-34](#)

Selected list [3-17](#)

sensitivity, for motion detection [4-7, 4-8](#)

Setup window

- description [2-9](#)
- displaying [2-8](#)

sharpness [4-2](#)

SNMP, configuring [3-23](#)

SNMP Settings window

- options [3-23](#)
- overview [3-23](#)

speaker

- external [1-4](#)
- installing [2-3](#)
- volume [4-4](#)

SSH

- allowing access through [3-29](#)
- alternative port [3-29](#)
- default port [3-29](#)

steps, in a patrol sequence [3-17](#)

stop bits, for pan/tilt device [3-10](#)

storage

- decrypting video files [2-14](#)
- managing [2-11](#)
- USB download decryption utility [2-12](#)
- USB flash drive
 - deleting files from [2-13](#)
 - downloading files from [2-13](#)
 - formatting [2-12](#)

Streaming Settings window

- options [3-4](#)
- overview [3-3](#)

subnet mask, of IP camera [3-20](#)

Syslog server [3-36](#)

T

terminal block [2-4](#)

text overlay, on video [3-8](#)

threshold, for motion detection [4-7, 4-8](#)

tilting [4-3, 4-5](#)

time out, of configuration windows [3-1](#)

Time Settings window

- options [3-21](#)
- overview [3-20](#)

time stamp, on video [3-8](#)

time zone, of IP camera [3-21](#)

trigger, for event [3-12](#)

troubleshooting

- administrator password recovery [5-1](#)
- alerts [5-2](#)
- cannot access IP camera through browser [5-1](#)
- motion detection [5-2](#)

U

USB download decryption utility [2-12](#)

USB storage

- decrypting video files [2-14](#)
- managing [2-11](#)
- USB download decryption utility [2-12](#)
- USB flash drive
 - deleting files from [2-13](#)
 - downloading files from [2-13](#)
 - formatting [2-12](#)

user, password [3-30](#)

user name, requirements for [3-30](#)

User Settings window

- options [3-30](#)
- overview [3-30](#)

V

video

- bit rate [3-5](#)
- primary stream [3-3](#)
- quality [3-5](#)
- secondary stream [3-3](#)
- text overlay [3-8](#)
- time stamp on [3-8](#)
- viewing live
 - through Home window [4-1](#)
 - through third-party device or software [4-1](#)*See also* live video
- video codec
 - controls in Camera Video/Control window [4-1](#)
 - display in Streaming Settings window [3-5](#)
- video image
 - controls in Camera Video/Control window [4-2](#)
 - optimizing for lighting condition [3-6](#)
- Video Overlay Settings window
 - options [3-8](#)
 - overview [3-8](#)
- video resolution
 - configuration guidelines [3-3](#)
 - controls in Camera Video/Control window [4-2](#)
- View Video link [2-8](#)

W

white balance [4-2](#)

