

 **SENNHEISER**

digital wireless system
MX W1



Instruction manual

Contents

Important safety instructions	2
MX W1 digital wireless earphone system	4
Delivery includes	4
Product overview	5
LED indications of the devices	6
Putting the MX W1 into operation	6
Charging the MX W1	6
Associating the earphones to the transmitter (Pairing)	9
Setting up your MX W1 for usage	12
Using the MX W1	14
Switching the earphones on/off	14
Switching the transmitter on/off	15
Putting on the earphones	16
Care and maintenance	17
Get the most out of your Sennheiser MX W1!	19
Troubleshooting	20
Accessories and spare parts	22
Specifications	23
Manufacturer declarations	24

Important safety instructions

The MX W1 has been manufactured according to the accepted rules of safety and current technology. However, there is still a danger of damage to equipment if the following general safety instructions are not complied with.

- Please read these instructions for use carefully and completely before using the devices.
- Make these instructions for use easily accessible to all users at all times. Always include these instructions for use when passing the devices on to third parties.
- Do not use the devices in situations which require special attention (e.g. in traffic or when performing skilled jobs).
- Always keep the devices dry and do not expose them to extreme temperatures (normal operating temperatures: 0 °C to 40 °C).
- Use the devices with care and store them in a clean, dust-free environment.
- Switch off the devices after use to conserve battery power. Remove the batteries if the earphones will not be used for extended periods of time.
- Protect your hearing from high volume levels. Sennheiser earphones also sound exceptionally good at low volumes.
- Use only Sennheiser supplied charging cables and power supply units.

Intended use of the devices

Appropriate use of the devices includes:

- having read and understood these instructions, especially the section "Important safety instructions",
- using the devices within the operating conditions and limitations described in this instruction manual.

Safety instructions for Lithium-Ion rechargeable batteries

If abused or misused, rechargeable batteries may leak. In extreme cases, they may even present a



- heat hazard
- fire hazard
- explosion hazard
- smoke and gas hazard

Please understand that Sennheiser does not accept liability for damage arising from abuse or misuse.



Keep away from children.



Do not heat above 70°C/158°F, e.g. do not expose to sunlight or throw into a fire.



Do not expose to moisture.



Do not short-circuit.



Do not mutilate or dismantle.



Do not get fully charged but unpacked rechargeable batteries mixed up.



Do not continue to use defective rechargeable batteries.



Only use original Sennheiser rechargeable batteries.



Observe correct polarity.



Switch rechargeable battery-powered devices off after use.



Remove rechargeable batteries when the unit is not used for extended periods of time.



Only charge rechargeable batteries with the appropriate Sennheiser chargers.



When not using rechargeable batteries for extended periods of time, charge them regularly (about every three months).



Only charge rechargeable batteries at ambient temperatures between 10°C and 40°C.



Immediately remove rechargeable batteries from obviously defective devices.



Dispose of rechargeable batteries at special collection points or return them to your specialist dealer.

MX W1 digital wireless earphone system

Thank you for purchasing MX W1 - Sennheiser's completely digital wireless earphone system. We trust that you will enjoy using it and that it will satisfy your expectations.

The MX W1 is simple to operate. These instructions for use have been designed to help you get started. Please take some time to read them carefully so as to ensure your utmost listening pleasure.

Enjoy your new MX W1!

Delivery includes

- 1 MX W1-T transmitter
- 2 MX W1-R earphones (left/right) incl.
 - earpads (1 pair, foam)
 - twist-to-fit pads (3 pairs: size S/M/L)
- 1 MX W1-C docking station
- 1 carrying case
- 1 elastic fabric strap
- 4 rubber bands (2 x S/2 x L)
- 1 charging cable with USB plug
- 1 power supply unit with 4 country adaptors (US/UK/EU/AU)
- 1 instructions for use

Product overview

Earphones

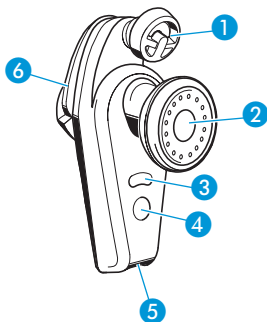

- 1 Twist-to-fit pad
- 2 Speaker
- 3 LED (orange/blue)
- 4 Operation/pairing button of the earphone
- 5 2.5 mm charging jack
- 6 Battery compartment

Transmitter

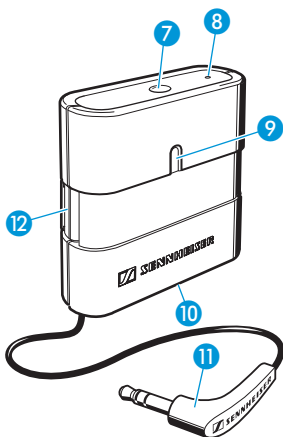

- 7 Operation/pairing button of the transmitter
- 8 Reset button
- 9 LED (orange/blue)
- 10 2.5 mm charging jack
- 11 Connecting cable with 3.5 mm stereo jack plug
- 12 Dowel pin

Docking station

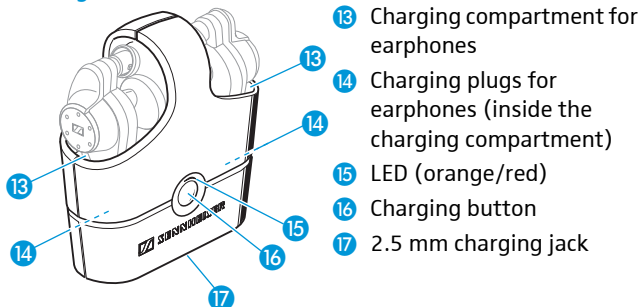

- 13 Charging compartment for earphones
- 14 Charging plugs for earphones (inside the charging compartment)
- 15 LED (orange/red)
- 16 Charging button
- 17 2.5 mm charging jack

LED indications of the devices

LED	Description
orange	Charging of a device (see following chapter) Docking station: Battery capacity < 5%
red	Charging of the docking station (see following chapter)
blue	Associating the earphones to the transmitter (see page 9) Switching the devices on/off (see page 14) Transmitter/earphones: Battery capacity < 5%

Putting the MX W1 into operation

Charging the MX W1

Charge the rechargeable batteries of all MX W1 devices for 3 hours before first use.

When the battery is almost flat, the LED 3, 9 or 15 flashes orange. You then have to charge the device.

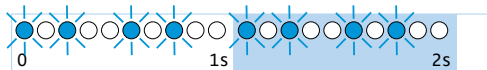

Charging the devices

CAUTION! Danger of damage to the USB interface!



The USB interface  of your computer can be damaged if you connect the docking station using the charging cable **19**. This can lead to an overload of the USB interface.

- ▶ Only charge the docking station using the power supply unit **18**.

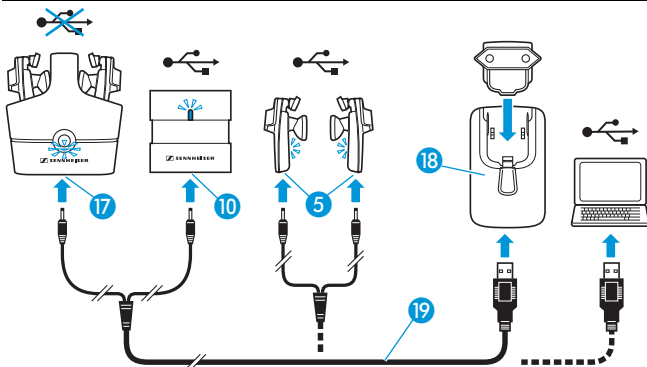

To charge the devices (simultaneously or separately):

- ▶ Connect the charging cable **19** to the power supply unit **18**.
- ▶ Connect the suitable country adaptor to the power supply unit **18**.
- ▶ Connect the charging cable **19** to the charging jack of:
 - the transmitter **10** and the docking station **17**
 - or the earphones **5**.
- ▶ If you want to charge all devices at one go, insert the earphones into the charging compartments **13** of the docking station.

- ▶ Plug the country adaptor into a wall socket. The batteries are being charged. The corresponding LEDs light up.
- ▶ Charge the rechargeable batteries until the LEDs go off (approx. 2 hours).

Note:

- The transmitter has its own built-in rechargeable battery. So it will not drain your audio device's battery.
- With a fully charged rechargeable battery, the operating time of the transmitter is approx. 10 hours and of the earphones approx. 3 hours.

Charging the earphones on the move

When on the move, the earphones can be charged up to three times in the docking station, without the docking station having to be connected to the mains.

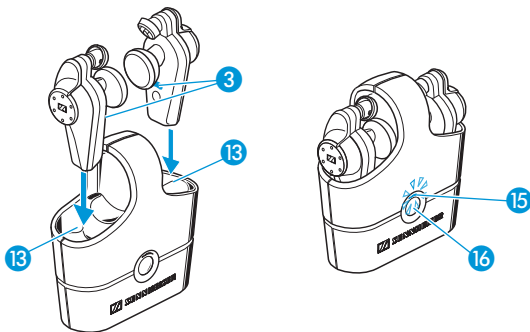

- ▶ Insert the earphones into the charging compartments 13 of the docking station. Make sure that the earphones are inserted correctly.
- ▶ Press the charging button 15 to start charging. The rechargeable batteries are being charged. The LEDs 3 and 15 light up.
- ▶ Charge the rechargeable batteries until the LEDs go off.

Associating the earphones to the transmitter (Pairing)

The MX W1 earphones and transmitter are already paired on delivery.

To enable wireless transmission, both the earphones and the transmitter have to recognize each other:

1. Enrollment mode



After switch-on, a suitable device is searched.

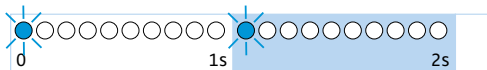

2. Association mode



If a suitable device is detected, both devices will exchange device identification information.

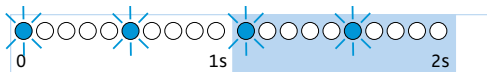

3. Pairing mode



If the exchange of device identification information is possible, the devices automatically try to connect.

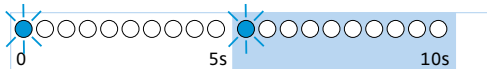

Associating a second pair of earphones to the transmitter

With one transmitter you can associate up to two pairs of earphones. If you want to use another pair of earphones, you have to pair your transmitter and the new earphones:

- ▶ Switch the **new** earphones off (see page 14).
- ▶ Switch the transmitter and the already paired earphones on (see page 14).



- ▶ Switch the transmitter off (see page 14).

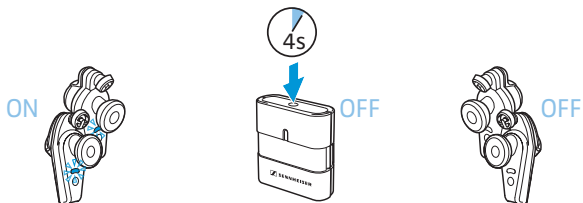

- ▶ Press and hold the operation/pairing button  of the **new** earphones until the LEDs flash **rapidly**.



-
- ▶ Press and hold the operation/pairing button  of the transmitter until the LED flashes rapidly.

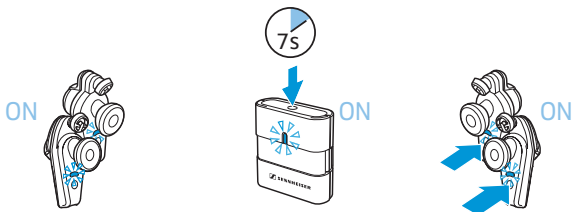

After approx. 3 seconds, the new earphones are also paired to the transmitter. The LEDs flash blue once every 5 seconds.

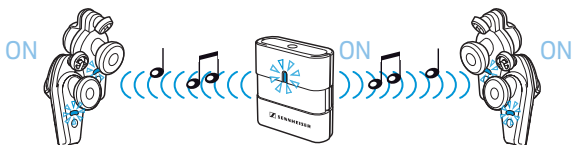

Note:

The distance between transmitter and earphones should not exceed 1 m during association.

Associating the earphones to Klear compatible devices

MX W1 is fully compatible to Klear wireless standard. For pairing the MX W1 with other Klear compatible devices, please refer to the preceding chapter and to the user manual of your device in question.

Setting up your MX W1 for usage

Fixing the transmitter to your audio device

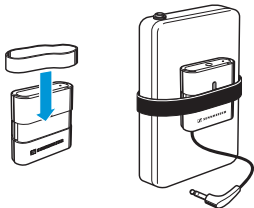

Fix the transmitter with the help of:

- the fabric strap
- or one of the rubber bands (see illustration).

Connecting the transmitter to your audio device

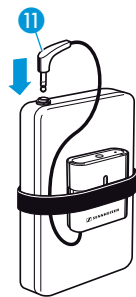

You can connect the transmitter to an MP3 player or any audio device with a 3.5 mm stereo headphone socket:

- ▶ Connect the stereo plug of the transmitter **11** to the 3.5 mm stereo headphone socket of your audio device.

Adjusting the earphones to your ears

Sennheiser's twist-to-fit system and comfortable earpads allow for the best custom fit enabling you to enjoy seamless high fidelity stereo sound. The perceived sound quality of the earphones depends to a large extent on a correct fit. For best sound enjoyment, please use the supplied earpads and twist-to-fit pads.

If the pre-mounted twist-to-fit pads (size M) do not fit your ear, use the smaller or larger ones.

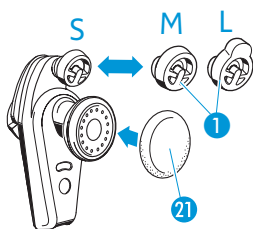

- ▶ Carefully remove the twist-to-fit pads 1 from the earphones.
- ▶ Mount the new twist-to-fit pads 1 to the earphones.
- ▶ Pull the earpads 21 over the speakers.

Using the MX W1

To switch the system on, proceed as follows:

1. Switch your audio device on.
2. Switch the earphones on (see following chapter).
3. Switch the transmitter on (see page 15).
4. Put the earphones on (see page 16).
You will hear the sound from your sound source.

Switching the earphones on/off

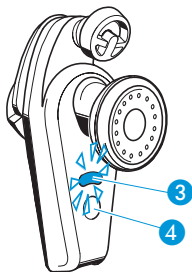

To switch the earphones on:

- ▶ Remove the earphones from the docking station
or:
- ▶ Press and hold the earphones' operation/pairing button ④ until the LEDs ③ flash blue.

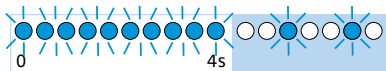

The earphones switch on.

To switch the earphones off:

- ▶ Press and hold the operation/pairing button ④ until the LEDs ③ light up blue.

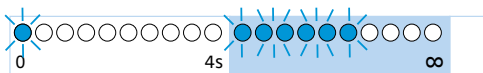

The earphones switch off.

Note:

- When you insert the earphones into the docking station, the earphones automatically switch off.
- If there is no transmitter in enrollment mode for at least 5 minutes, the earphones automatically switch off.

Switching the transmitter on/off

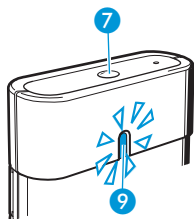

To switch the transmitter on:

- ▶ Press and hold the transmitter's operation/pairing button 7 until the LED 9 flashes blue.

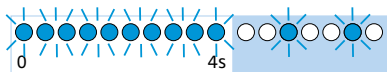

The transmitter switches on.

To switch the transmitter off:

- ▶ Press and hold the operation/pairing button 7 until the LED 9 lights up blue.

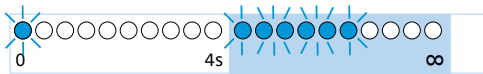

The transmitter switches off.

Note:

- The transmitter remains switched on during charging. To switch the transmitter off, press and hold the operation/pairing button 7 for 4 seconds.
- If there are no earphones in enrollment mode for at least 5 minutes, the transmitter automatically switches off.

Putting on the earphones

CAUTION! Danger of hearing damage!



Listening at high volume levels for long periods can lead to permanent hearing defects. Sennheiser earphones also sound exceptionally good at low volumes.

- ▶ Set the volume of the audio device to the minimum before switching the earphones on.
-

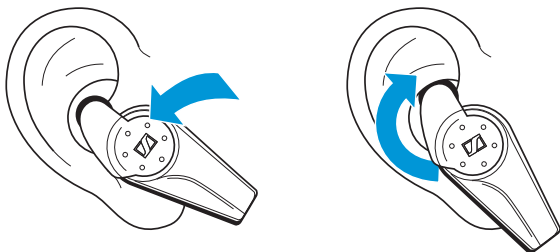

- ▶ Check the **R** (right) and **L** (left) marks on the earphones to identify them and put on the earphones as shown in the illustration above.

Care and maintenance

Cleaning the devices

CAUTION! Liquids can damage the electronics of the devices!



Liquids entering the housing of the devices can cause a short-circuit and damage the electronics.

- ▶ Keep all liquids away from the devices.
- ▶ Do not use any cleansing agents or solvents.

For reasons of hygiene, clean your Sennheiser products regularly.

- ▶ Before cleaning, disconnect the devices from the mains.
- ▶ Only use a slightly damp cloth to clean the devices.

Changing the twist-to-fit pads/earpads/rubber rings

For reasons of hygiene, the twist-to-fit pads, earpads and rubber rings should be replaced from time to time. Please order these spare parts from your Sennheiser dealer.

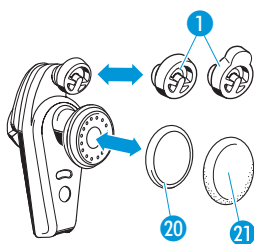

- ▶ Carefully remove the twist-to-fit pads **1** / rubber rings **20** / earpads **21** from the earphones.
- ▶ Mount the new twist-to-fit pads **1** / rubber rings **20** to the earphones.
- ▶ Pull the earpads **21** over the speakers.

Replacing the earphones' rechargeable batteries

CAUTION! Danger of damage to the devices!



Rechargeable button cells from other manufacturers may cause damage to the earphones and will invalidate the warranty.

- ▶ Only use original Sennheiser rechargeable button cells (see page 22).

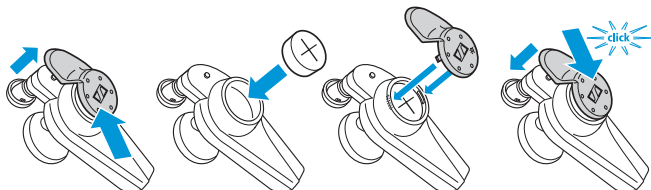

- ▶ Slightly lift the end of the caps and slide the caps out of the guide rails.
- ▶ Insert the new rechargeable batteries as shown. Observe correct polarity when inserting the batteries.
- ▶ Replace the caps **6** and slide them onto the guide rails until it clicks audibly.
- ▶ Charge the earphones until the corresponding LEDs go off (see page 8).

Get the most out of your Sennheiser MX W1!

Your Sennheiser MX W1 uses the latest digital wireless transmission technology. This technology offers high transmission quality and reliability but, like other wireless technologies, can also be influenced by various factors such as:

- objects or walls, as these can reflect (amplify) or attenuate the transmitted signal.
- the position of the transmitter on your body: optimally, the distance to both earphones should be the same.
- other wireless devices operating on similar frequencies (around 2.4 GHz) within your immediate vicinity.

In order to optimise the transmission quality of your MX W1, please make sure to:

- attach the transmitter at the centre of your chest or back,
- observe a minimum distance of 5 mm between your body and the transmitter,
- place the audio device between the transmitter and your body.

Troubleshooting

Problem	Possible cause	Possible solution
No operation indication	Battery is flat	Recharge the battery (see page 6, page 17)
No sound	Jack plug connection is incorrect	Check the connection to your audio device (see page 12)
	Transmitter or earphones are switched off	Switch the device on (see page 14)
	Audio device is switched off	Switch the audio device on
	Volume of the audio device is adjusted too low	Adjust the volume to a higher level
	Housing of player or something else blocks the transmission	Remove obstacles between transmitter and earphones
	Transmission between the transmitter and earphones is disturbed by any interferences in the vicinity	Briefly press the operation/pairing button 4 of the transmitter
Sound dropouts	Device is out of range	Reduce the distance between earphones and transmitter
	Signal is shielded	Remove obstacles between transmitter and earphones
	Interfering devices in the vicinity	Try relocation

Problem	Possible cause	Possible solution
Humming noise	Interference when charging from the PC	Charge from the power supply unit or choose a different audio source
Only one earphone has audio	Transmitter was switched on before the earphones were switched on	Briefly press the transmitter's operation/pairing button ④
Earphones cannot be switched on	Rechargeable batteries have just been replaced	Briefly charge the earphones (see page 18)

Resetting the transmitter to the factory settings

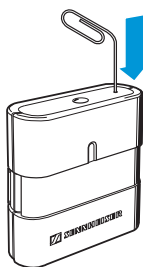

In case of system malfunction:

- ▶ Use a pointed tool to press the reset button for 1 second.

The transmitter is reset to the factory settings and then restarted.

If a problem occurs that is not listed in the above table or if the problem cannot be solved with the proposed solutions, please contact your local Sennheiser agent for assistance.

Accessories and spare parts

The following accessories are available from your authorized Sennheiser dealer:

Cat. No. Accessory/Spare part

- 525766 Carrying case
- 525767 MX W1-C docking station
- 525768 MX W1-T transmitter
- 525769 Transmitter straps:
1 elastic fabric strap, 4 rubber bands (2 x S/2 x L)
- 525770 Lithium-ion rechargeable button cell (2 pieces) for the earphones , 40 mAh, 3.7 V DC
- 525773 Design plates: battery compartment covers for the earphones (1 pair)
- 525774 Earpads (5 pairs, foam)
- 525775 Accessory pack: Twist-to-fit pads (4 pieces each of size) and 4 rubber rings
- 525776 MX W1 charging cable, power supply unit and country-adaptors
- 525777 MX W1-R earphone (left)
- 525778 MX W1-R earphone (right)

Specifications

System

Modulation	MSK Digital
Carrier frequencies	2.4 – 2.48 GHz
Range	approx. 10 m in open area
Power supply unit with country adaptors	Input: 100 – 240 V AC, 50/60 Hz, Output: 5 V DC/0.5 A (x 2)
Operating temperature	0 – 40 °C

Transmitter

Audio connection	3.5 mm stereo jack socket
Charging time of rechargeable battery	approx. 2 hrs
Power supply	Input: 5 V DC/120 mA
Operating time	approx. 10 hrs
Weight	approx. 16 g
Dimensions	approx. 40 x 13 x 40 mm

Earphones

Max. SPL	115 dB (SPL)
THD	<0.5 % at 1 kHz 100 dB SPL
Frequency response	19 Hz – 20 kHz
Charging time of rechargeable battery	approx. 2 hrs
Power supply	Input: 5 V DC/30 mA
Rechargeable battery (lithium-ion button cell)	3.7 V, 40 mAh
Operating time	approx. 3 hrs
Weight	approx. 10 g
Dimensions	approx. 29 x 20.5 x 51 mm

Docking station

Charging time of rechargeable battery	approx. 2 hrs
Power supply	Input: 5 V DC/400 mA Output: 5 V DC/100 mA
Weight	approx. 42 g
Dimensions	approx. 71 x 26 x 74 mm

“klear” wireless technology



klear
cut loose.

The MX W1 is based on “klear” digital wireless transmission technology.

- Multiple (stereo) earphones capability
- Lossless sound transmission (CD quality)
- Smaller size of the devices
- Lower battery consumption

The Klear logo is a trademark of Klear Inc.

Manufacturer declarations

Warranty

2 years

Declaration of Conformity

This equipment is in compliance with the essential requirements and other relevant provisions of Directives:

- R&TTE directive (1999/5/EC)
- EMC Directive (2004/108/EC)
- Low Voltage Directive (2006/95/EC)
- RoHS Directive (2002/95/EC)
- WEEE Directive (2002/96/EC).

The declaration is available on the internet site at www.sennheiser.com. Before putting the device into operation, please observe the respective country-specific regulations!

Statements regarding FCC and industry Canada

FCC Declaration of Conformity (DoC)



We,

Sennheiser Electronic Corporation
Strat. Marketing • Stefanie Reichert
One Enterprise Drive • Old Lyme •
CT 06371 • USA
Tel: +1 (860) 434 9190, ext. 144
Fax: +1 (860) 434 1759

declare the above device comply with the requirements of Federal Communications Commission.

This device complies with Part 15 of the FCC rules. Operation is subjected to the following two conditions:

- 1) This device may not cause harmful interference, and
- 2) This device must accept any interference received, including interference that may cause undesired operation.

Responsible Party: John Falcone

This device complies with Part 15 of the FCC Rules and with RSS-210 of Industry Canada. Operation is subject to the following two conditions: (1) this device may not cause harmful interference, and (2) this device must accept any interference received, including interference that may cause undesired operation.

This equipment has been tested and found to comply with the limits for a Class B digital device, pursuant to Part 15 of the FCC Rules. These limits are designed to provide reasonable protection against harmful interference in a residential installation. This equipment generates, uses and can radiate radio frequency energy and, if not installed and used in accordance with the instructions, may cause harmful interference to radio communications. However, there is no guarantee that interference will not occur in a particular installation. If this equipment does cause harmful interference to radio or television reception, which can be determined by turning the equipment off and on, the user is encouraged to try to correct the interference by one or more of the following measures:

- Reorient or relocate the receiving antenna.
- Increase the separation between the equipment and receiver.
- Connect the equipment into an outlet on a circuit different from that to which the receiver is connected.
- Consult the dealer or an experienced radio/TV technician for help.

This class B digital apparatus complies with the Canadian ICES-003. Changes or modifications made to this equipment not expressly approved by Sennheiser electronic Corp. may void the FCC authorization to operate this equipment.

Meet the requirements for:

USA: FCC ID: DMOMXW1T 
DMOMXW1R

Canada: IC: 2099A-MXW1T
2099A-MXW1R

Europe:  **0560**  

Australia &
New Zealand:  N340

Singapore:

Complies with IDA Standards DB100582
--

Russia: 
МЛ04



Sennheiser Consumer Electronics GmbH (Singapore Branch)

96 Robinson Road, #16-01/04, Singapore 068899

Phone: +65 64116911

Fax: +65 64380476

Sennheiser electronic GmbH & Co. KG (EU Representative)

Am Labor 1, 30900 Wedemark, Germany

Phone: +49 (5130) 600 0

Fax: +49 (5130) 600 300

www.sennheiser.com

Printed in China

Publ.03/08

528224/A01

