

OWNER'S MANUAL



E03

Personal In-Ear Monitor
Wireless System



Contents

Introduction	3
Important Note	3
EO3 Transmitter	4
EO3 Receiver	6
Specifications	8
Service Information	9
Warranty	10

Nady wireless systems are type accepted under FCC rules parts 90, 74 and 15.

This device complies with RSS-210 of Industry & Science Canada. Operation is subject to the following two conditions: (1) this device may not cause harmful interference and (2) this device must accept any interference received, including interference that may cause undesired operation.

Introduction

Thank you for choosing the Nady EO3 Personal In Ear Monitor™ wireless system, we know you will be very pleased with its performance and features. The EO3 provides high quality, yet cost-effective in-ear monitoring to on stage performers or behind the scenes personnel. The system is designed to be very easy to use and requires no installation.

The EO3 consists of one wireless transmitter (EO3-T) and one or more wireless bodypack receivers (EO3-R) on the same channel. The transmitter features eight factory switchable channels; the receivers are single channel units that operate on one of eight channels in the 72-76 MHz band, with wide band modulation for quality audio. These frequencies are in a separate band that will not interfere with simultaneous use of VHF or UHF wireless systems on the same stage.

The EO3 system has a wireless operating range of 300 feet, which allows it to be used with confidence in venues from small clubs to large theatres.

The transmitter connects to a monitor or line out from any mixing console, and broadcasts the audio as an FM signal to any number of pocket size Nady EO3 receivers on the same channel. Each receiver is equipped with an adjustable volume control, and high performance earbuds. Earphone enhancers—unique clear soft plastic inserts that can help secure the earbuds—are included. The transmitter also provides a microphone input to allow wireless cueing of the performers on stage.

The EO3 can provide a high quality monitor mix at significantly lower decibel levels than floor monitors. This is an important benefit for artists who wish to protect their hearing from excessive and potentially damaging sound pressure levels.

Please read this manual completely before using your Nady EO3.

Important Note

Just as with any in-ear monitor system, the EO3 works best when used exclusively by all the performers on stage—without any wedges or side monitors. The high sound pressure levels produced by floor monitors (especially if the band plays loud) can bleed through the in-ear monitor earbuds, in the worst cases, thus hindering their effectiveness. Experiment with your mix to get the maximum benefit from your EO3.

EO3 Transmitter

The EO3 transmitter is a compact transmitter that broadcasts on one of eight channels in the 72-76 MHz band, to any number of EO3 wireless bodypack receivers on the same channel. The system provides a 300 ft. wireless operating range, and offers these features:

- Eight factory switchable channels
- Rear panel input for line level audio
- Front panel input for microphone
- Audio input gain control
- Automatic level control
- Extendible antenna
- 9 volt DC input for AC-EO3 9VDC regulated power supply adapter provided
- Power switch with red LED power on indicator
- Audio modulation LED indicator

Setting Up the Transmitter

Your EO3 requires minimum installation. Simply place the transmitter on any flat surface, connect your mixing board to the transmitter's back panel input (See *Connecting Audio Input* below), connect the included power supply (as explained below), and the transmitter is ready to broadcast to any number of EO3 receivers operating on the same channel.

Powering the Transmitter

Connect the AC adapter provided into the **9V DC jack (1)** on the back panel of the transmitter. Plug the other end into an AC wall socket. Press **Power switch (2)**. The **Power On LED (3)** will light.

Antenna

Extend **Antenna (4)** fully and position 90 degrees from top of the transmitter.

Connecting Audio Input

The **Line In jack (5)** on the rear panel lets you connect the EO3 to your mixing console. This $\frac{1}{4}$ " mono phone jack accepts an unbalanced line level audio source at zero dBm nominal signal level. If your mixer has XLR outputs only, you will need an XLR-to-phone plug adapter, available from most electronics stores and music equipment stores.

Using a Microphone

The **Mic jack (7)** on the front panel allows wireless cueing of on stage performers.

***Important:** This $\frac{1}{4}$ " mono phone jack is designed for an electret condenser microphone, and 9V DC power is present at the input jack. If you wish to use a conventional dynamic microphone, at least 20 dB more gain is required, and a preamp should be used. If a preamp is used, be sure to have a blocking capacitor (1 mfd) between the preamp output and the EO3 mic input. If a dynamic mic is plugged into the mic input by mistake, there should be no damage because the current is limited to 1.0 mA. If you have any questions, contact Nady Customer Service (510.652.2411) or your Nady dealer.*

Audio Input Gain Adjustment

You can quickly adjust the transmitter to obtain optimum performance with the **Input Gain control (8)**. The audio modulation indicator LED, marked **TX (6)** will increase in brightness as the control is turned clockwise, and decrease in brightness as the control is turned counterclockwise. When the "TX" LED is flashing during transmission, the transmitter is broadcasting properly. (If the LED stays off continuously or barely flashes at all, the input gain needs to be increased. If the LED stays on continuously and does not flash during modulation, the input is overloading and needs to be decreased.) You will also need to test the transmitter in use with an EO3 receiver. This procedure is easy to do, and is explained in the receiver instructions, which follow.

Confirming Correct Installation

The transmitter's **TX LED (6)** will flash when a microphone or line level signal is broadcast by the transmitter. If "TX" does not flash, turn the audio input gain control clockwise. This will increase audio level and cause "TX" to flash along with the program source. When "TX" is flashing, the transmitter is broadcasting properly. Test the transmitter with an EO3 receiver. This procedure is explained in the receiver instructions.

Note: For the best performance, and to minimize the possibility of interference from another source, we suggest you experiment to find the minimal height the antenna must be extended in order to perform well in your particular environment.

Channel Selection

Channel selection is controlled by DIP-switches inside the transmitter. The system is preset at the factory.

Changing the channel can be done quickly by any qualified service technician.

Contact your dealer or the Nady Customer Service Department for details.

Using More Than One EO3 System

You may operate up to three EO3 systems in the same location. For example, you may want to use one transmitter to provide a mix to the rhythm section, a second to provide a different mix for the vocalist. For multiple system operation, please observe:

- If operating two EO3 transmitters in the same location, use Ch. AA and HH (or GG)
- If operating three EO3 transmitters in the same location, use Ch. AA, EE and HH (or GG)
- Locate the transmitters ten feet or more away from the performers wearing EO3 receivers

EO3 Transmitter (Front Panel)

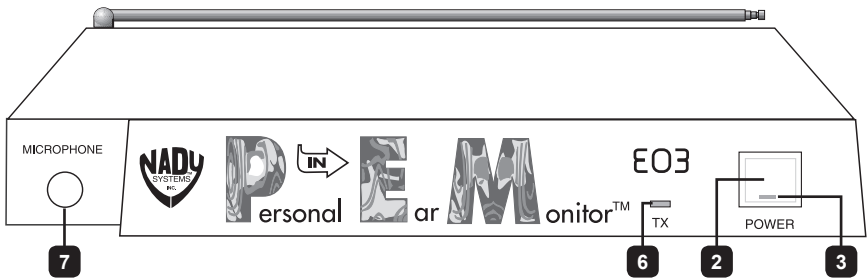

EO3 Transmitter (Rear Panel)

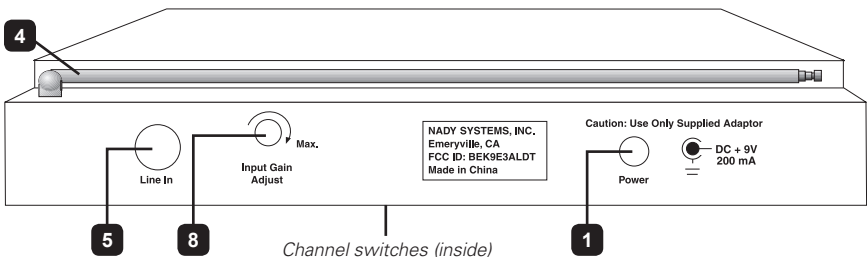

EO3 Receiver

The EO3 receiver is a pocket sized wireless audio receiver with an output for earbuds to provide in ear monitoring, and offers these features:

- Any number of EO3 receivers can be used with a single EO3-T transmitter
- Ultra compact and lightweight
- Preset to one of eight channels in the 72-76 MHz range
- Loudness adjustable with volume control—provides up to 130dB in-ear monitoring
- Antenna is integral with earphone cord
- A pair of mini binaural EB-3 earphones included, with optional-use EMI soft rubber inserts supplied
- LED “Power On” indicator
- Accepts standard 9V alkaline battery

Channel Selection

Your receiver is pre-tuned at the factory to the same channel as your transmitter. Should you wish to have your transmitter channel changed, as explained in the Transmitter section of this manual, you must also have your receiver(s) retuned as well. Contact the Nady Customer Service Department for details.

Powering The Receiver

Install a 9V battery in **Battery Compartment (1)**, observing polarity. To preserve battery life, always turn the EO3 receiver off when it is not in use. When the sound becomes weak or distorted, replace the battery. The number of hours of operation per battery is as follows: carbon zinc type battery: 10-12 hours; alkaline battery (recommended): 17-20 hours.

Using the Earbuds

Simply plug the included earbuds into the **Earphone jack (2)** on top of the receiver.

***Note:** Proper sound levels on stage are essential for optimum effectiveness of any in-ear monitor system. (See also “Important Note” on page 1). If sound levels are high, it is important to properly seal out unwanted sound so the earbud can be effective in providing proper monitoring. Top high end in-ear monitor systems use special transducers imbedded in a soft plastic mold of the users ear canal. This ensures a perfect seal and maximum immunity from bleed through. Such ear mold speakers are very expensive and can be used with the EO3 for optimum results—call Nady Systems for more information.*

The EB-3 mono earbud earphones supplied with the EO3-R receiver offer great sound and can also provide top results if utilized properly. If sound pressure levels are high and bleed through is a problem, care must be taken to ensure a proper fit and a tight seal. Although the earphones can often be used effectively simply as “Walkman”-style earbuds, for best results in high SPL environments you must also use the supplied EMI-S/M/L soft **Rubber inserts (5)**. Choose the correct size (small, medium or large) from the three sets provided for a custom fit, and slip over the earphones before inserting in your ears. Although the maximum volume available may be slightly diminished, use of the EMI inserts does provide a better sound seal, increased immunity from bleed through and mimics the results available with custom-made ear mold speakers.

Operating the Receiver

While wearing your earbuds, turn the receiver on by rotating the **On/Off volume wheel (3)**. The **Power On indicator (4)** will go on. (To turn the receiver off, rotate the On/Off/Volume wheel until it clicks, and the “Power On” indicator will go out.)

Adjusting Ear Monitor Volume

Listen for your program source, and adjust receiver volume to a comfortable listening level. The EO3 receiver is capable of providing listening levels loud enough to be heard in use with a rock band. Many bands use on stage loudness levels that with repeated exposure could pose a threat to their hearing. Therefore, it is very important that the EO3 be used at a reasonable and comfortable listening level.

Note: A slight hum may be heard if the receiver is used within six feet of the transmitter. This is normal and does not affect performance.

Testing Receiver Range

Wearing your receiver and earphones, walk around the stage area (and sound board and other areas if crew members are to be equipped with EO3 receivers) and listen for audio quality. In certain areas of the room the audio may disappear or “drop out.” This is a normal occurrence whenever radio signals are transmitted inside a building. If you step away from the “drop out” zone, the audio will return. If a drop out zone is within the area of the stage or sound board(s), it is possible to eliminate the drop out zone by moving your EO3 transmitter as little as 12-18 inches in any direction. After you move the transmitter, “range walk” the stage and other areas again to check for consistent reception.

EO3 Receiver (Front Panel)

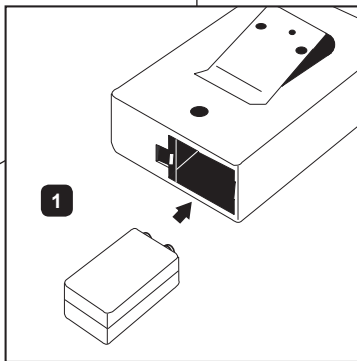
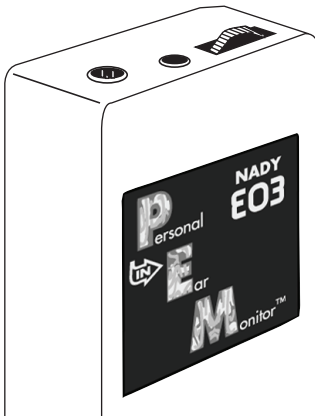

EO3 Receiver (Top Panel)

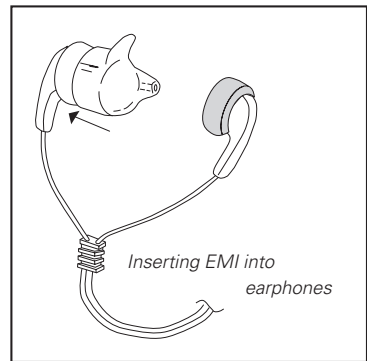
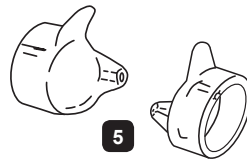
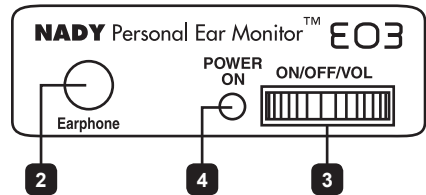

E03 Specifications

OVERALL SYSTEM PERFORMANCE

Frequency Response	100 Hz - 10KHz \pm 3 dB
Signal-to-Noise Ratio	60 dB
Total Harmonic Distortion	< 0.5%
RF Carrier Frequencies	Eight factory preset channels between 72-76 MHz Channel AA: 72.1, BB: 72.3, CC: 72.5, DD: 72.7 EE: 72.9, FF: 75.5, GG: 75.7, HH: 75.9
Frequency Stability	Better than .005%
Modulation	FM \pm 75 KHz
Operating Range	Up to 300 feet line-of-sight

E03-T TRANSMITTER

Line Input	Connector: One 1/4" phone jack Impedance: 100 K Ohms, unbalanced.
Mic Input	Connector: One 1/4" phone jack Impedance: low impedance, unbalanced, with 9 VDC at 1 mA for condenser mic.
Power Output	80,000 μ V @ 3 meters
Controls	Power On/Off, audio input gain adjust
Indicators	Power On LED, Audio Modulation "TX" LED
Antenna	Permanently mounted telescoping whip
Power Requirement	9 VDC regulated, @ 200 mA, AC-E03 adapter provided
Dimensions	1.25" H, 8.25" W, 4.25" D (3.175 x 20.9 x 10.8 cm)
Weight	18.2 oz. (500 g.)

E03-R RECEIVER

Controls	Combination volume/on-off wheel
Audio Output	100 mW max into 16 Ohms
Connectors	3.5 mm mini jack for earbuds output
Earphones	Binaural EB-3 earbuds with optional-use EMI soft rubber inserts
Antenna	Integral with earbud cord
Indicators	LED power on indicator
Sensitivity	2 μ V for 12 dB Sinad with squelch defeated Squelches at 10 μ V for min. 50 dB S-N ratio
Mute Threshold	8-10 μ V
Power Requirement	9V carbon zinc or alkaline battery
Battery Life	17-20 hours with alkaline battery; 10-12 hours with carbon zinc battery
Dimensions	3.35" H, 2.75" W, .75" D (8.5 x 6.5 x 2.25 cm)
Weight	2.65 oz. without battery (73 g)

Specifications subject to change at any time without prior notice for purposes of product improvement

Service Information

In the U.S. If you are experiencing operational problems with your system, please refer to the Support page at www.nady.com for assistance. Should your wireless system require service, please contact the Nady Service Department at (510) 652-2411 to obtain a Return Authorization (R/A) Number and service quote (if out of warranty). Make sure the R/A Number is clearly marked on the outside of the package that you are returning.

If your unit is out of warranty, please enclose a cashier's check or money order (or pay by credit card) per instructions by the Nady Service Department. Ship your unit prepaid to: Nady Systems, Service Department, 6701 Shellmound Street, Emeryville, CA 94608. Include a brief description of the problem you are experiencing. For service of a unit under warranty, please follow the instructions in the following section.

Outside the U.S. For service or warranty matters please contact the Nady distributor in your country through the dealer/store from which you purchased this product.

Do not attempt to service this unit yourself as it can be dangerous and will also void the warranty.

One-Year Limited Warranty

Nady Systems, Inc. warrants to the original consumer purchaser that the unit is free from any defects in material or workmanship for a period of one year from the date of original retail purchase. If any such defect is discovered within the warranty period, Nady Systems, Inc. will repair or replace the unit free of charge, subject to verification of the defect or malfunction upon return to Nady Systems. Please do not return your Nady product to the store where it was purchased as Nady Systems handles your warranty service directly. Communication with our Service Department is the most efficient means of servicing your unit and we are dedicated to keeping you a satisfied customer.

To the extent permitted by law, any applicable implied warranties, including warranties of merchantability and fitness are hereby limited to one year from the date of purchase. Consequential or incidental damages resulting from a breach of any applicable express or implied warranties are hereby excluded. This warranty is in lieu of all other agreements and warranties, general or special, express or implied and no representative or person including a Nady dealer, agent, or employee is authorized to assume for us any other liability in connection with the sale or use of this Nady Systems' product.

Whereas some states do not allow limitations on how long implied warranties last, and do not allow exclusion of incidental or consequential damages, the above limitations and exclusions may not apply to you. This warranty gives you specific legal rights and you may also have other rights which may vary from state to state.

This warranty is subject to the following conditions:

- 1) This system must have been purchased from an authorized Nady dealer and all warranty service must be performed by Nady's service department. Any service not performed by Nady will automatically void this warranty.
- 2) Items not covered: physical damage resulting from improper handling of the unit in transit from the factory by the shipper (Nady Systems is not responsible for such damage and all such claims must be made against the shipping company by the consignee); defects caused by normal wear of the product (expendable parts are typically connectors, cables, potentiometers, switches and similar components); damage or defects caused by abuse, neglect, accident, failure to connect or operate the unit in any way that does not comply with applicable technical or safety regulations, or improper repair, excessive heat or humidity, alteration or unreasonable use of the unit, causing cracks, broken cases/housings or parts; damage caused by leaking batteries; finish or appearance items; items damaged in shipment en route to Nady Systems, Inc. for repair. The warranty is null and void if any Nady serial number has been removed or defaced.

How To Obtain Service:

- 1) If factory service is required, please contact our Service Department at (510) 652-2411 for a return authorization (R/A) number. Make sure the R/A number is clearly marked on the outside of your package. (Please note: if an R/A number is not included, our Shipping Department cannot accept your package.)
- 2) Send the unit back to Nady Systems, 6701 Shellmound Street, Emeryville, CA, 94608, freight pre-paid. You must include proof of date and place of purchase (i.e., photocopy of your bill of sale) or Nady cannot be responsible for repair or replacement. Nady Systems, Inc. will not repair, nor be held responsible, for any units returned without proper identification, return address, and R/A number clearly marked on the package.
- 3) Per the above, Nady will perform all warranty service and return the unit to you at no charge. Nady Systems will inform the buyer if product sent in does not meet the terms of this warranty and will provide a quote for fixing the unit and/or shipping it back exclusively at the buyer's expense.



6701 Shellmound Street | Emeryville, CA USA 94608
T 510.652.2411 | F 510.652.5075 | www.nady.com