

SAMSUNG

**OWNER'S INSTRUCTIONS &
INSTALLATION MANUAL
MANUAL DE INSTRUCCIONES &
MANUAL DE INSTALACIÓN
MANUEL D'UTILISATION &
MANUEL D'INSTALLATION**

**Indoor Unit
AM18B1C09
AM26B1C13
AM27B1C07
AM27B1C13**

**Outdoor Unit
UM18B1C2
UM26B1C2
UM27B1C3**

ENGLISH

ESPAÑOL

FRANÇAIS

**MULTI-SPLIT TYPE ROOM AIR CONDITIONER (Cool)
ACONDICIONADOR DE AIRE DOMÉSTICO SISTEMA MULTI SPLIT (Refrigeración)
CLIMATISEUR DE TYPE MULTIPLE (Refroidissement)**

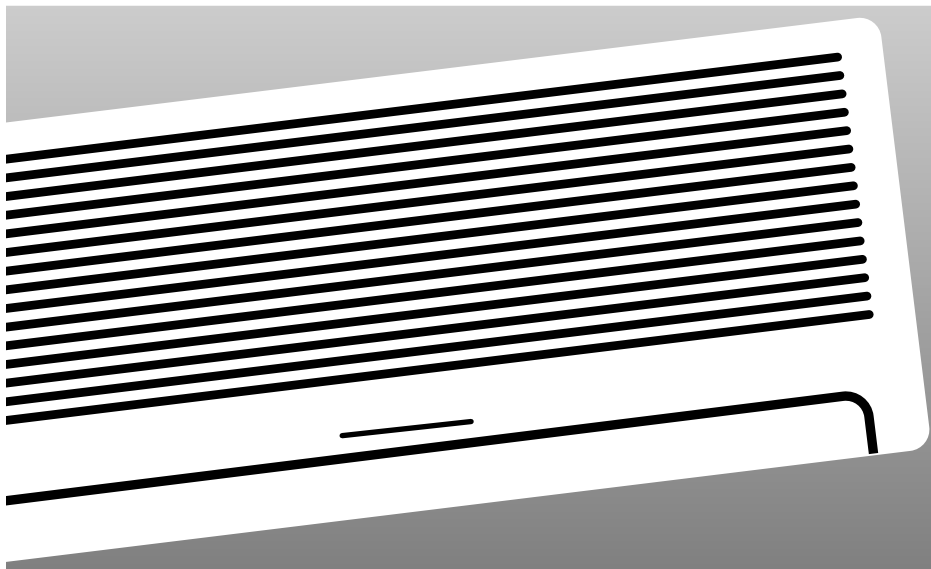

Safety Precautions

The following safety precautions must be taken when using your air conditioner.

- 1 *Make sure that the indoor unit is correctly ventilated at all times; do NOT place clothing or other materials over it.*
- 2 *NEVER spill liquid of any kind into the indoor unit. Should this happen, switch off the breaker used for your air conditioner and contact your installation specialist.*
- 3 *Do NOT insert anything between the air flow blades, as the inner fan may become damaged and you may be hurt. Keep children away from the indoor unit.*
- 4 *Do NOT place any obstacles in front of the outdoor unit.*
- 5 *If the remote control will not be used for a long time, remove the batteries.*
- 6 *Users of this product are cautioned not to attempt repair of this product at their own discretion. Instead, they are requested to directly contact a designated service center or the outlet at which the product was purchased.*
- 7 *If the supply cord is damaged, it must be replaced by a special cord or assembly available from the manufacturer or its service centre.*
- 8 *This device must be installed according to the national electrical rules.*
- 9 *Before disposing of the remote control it is necessary to remove batteries.*
- 10 *The appliance is not intended for use by young children or infirm person without supervision; young children should be supervised to ensure that they do not play with the appliance.*
- 11 *Max current is measured according to IEC standard for safety and current is measured according to ISO standard for energy efficiency.*

CAUTION

The manufacturer does not take any responsibility for any accidents that occur because the air conditioner is not fixed firmly or installed securely, during installing or using the product. In case you experience difficulty in installation, you must use an installation specialist. An accident will occur if the installation is not done as recommends in the installation guide.

Contents

◆	PREPARING YOUR AIR CONDITIONER	
■	Safety Precautions	2
■	View of the Unit	4
■	Remote Control-Buttons and Display	6
■	Getting Started	7
■	Inserting the Remote Control Batteries	8
■	Installing the Remote Controller Holder	8
◆	OPERATING YOUR AIR CONDITIONER	
■	5 Way Function	9
■	Selecting the Automatic Operating Mode	10
■	Cooling Your Room	11
■	Changing the Room Temperature Quickly	12
■	Removing Excess Humidity	13
■	Airing Your Room	14
■	Adjusting the Air Flow Direction Vertically	15
■	Adjusting the Air Flow Direction Horizontally	15
◆	PROGRAMMING YOUR AIR CONDITIONER	
■	Setting the On Timer	16
■	Setting the Off Timer	17
■	Setting the Sleep Timer	18
◆	RECOMMENDATIONS FOR USE	
■	Operating Recommendations	19
■	Temperature and Humidity Ranges	20
■	Cleaning Your Air Conditioner	21
■	Solving Common Problems	22
■	Installing a Filter (Option)	23
◆	TECHNICAL SPECIFICATIONS	

View of the Unit

The design and shape are subject to change according to the model.

Indoor Unit

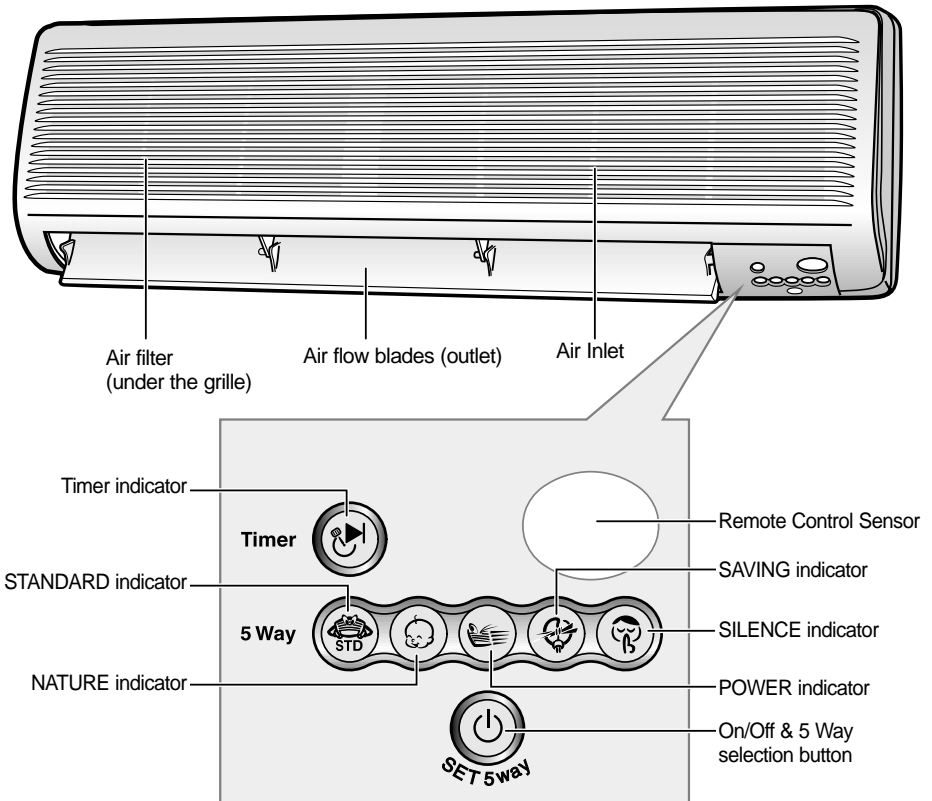

Note ◆ For details on the 5 Way, refer to page 9.

Outdoor Unit UM18B1C2

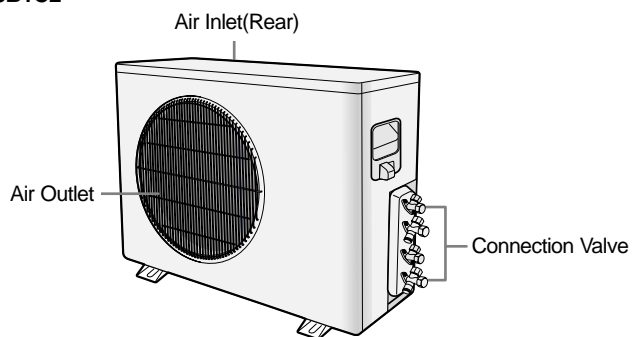

Outdoor Unit UM26B1C2

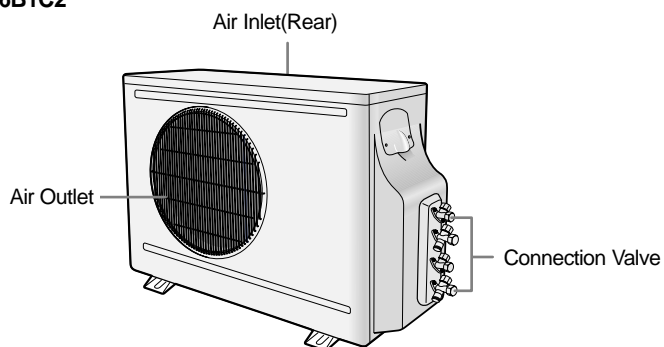

Outdoor Unit UM27B1C3

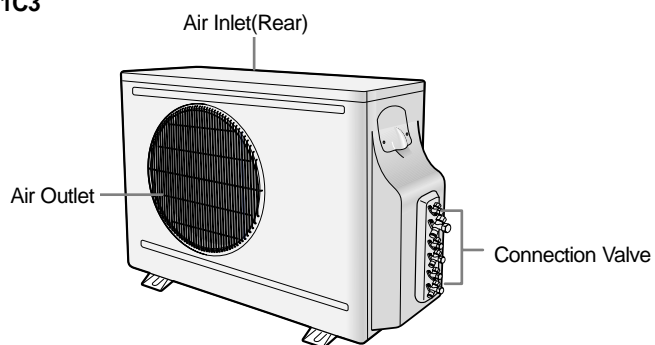

Remote Control - Buttons and Display

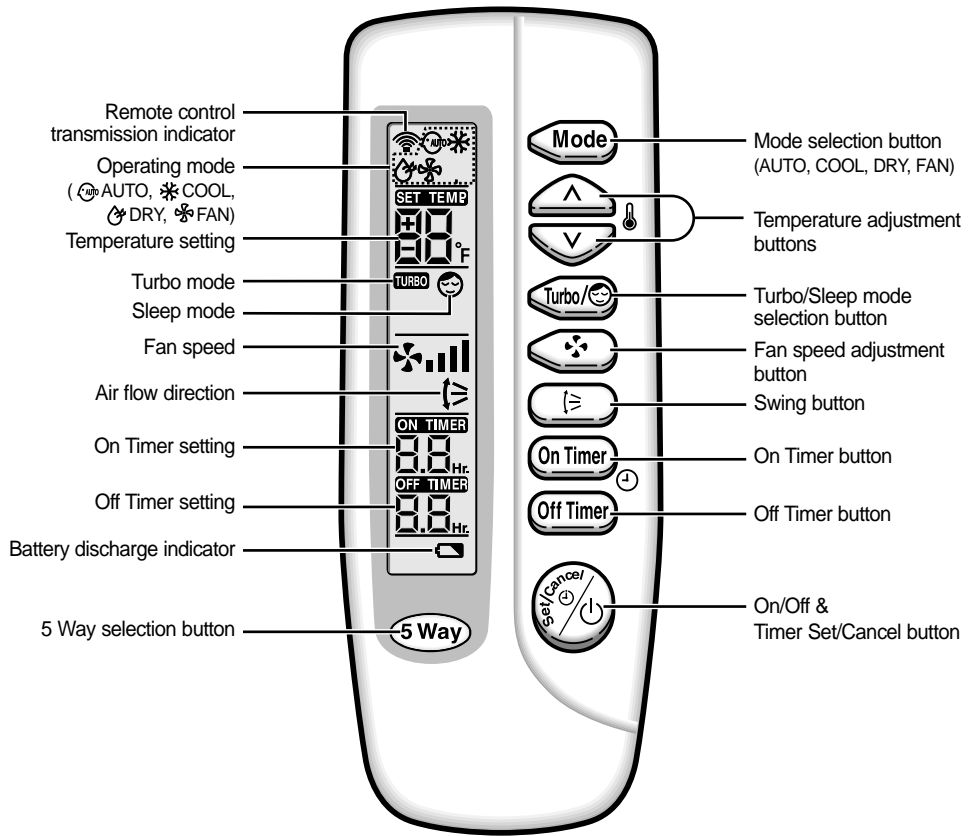

Getting Started

You have just purchased a split type air conditioner and it has been installed by your installation specialist.

Your Owner's Instructions contains valuable information on using your air conditioner. Please take the time to read it as it will help you take full advantage of the unit's features.

The booklet is organized as follows.

- ◆ *The following figures are shown on pages from 4 to 6 :*
 - *Indoor and outdoor units*
 - *Remote control(buttons and display)**They will help you find the buttons and understand the symbols displayed.*

- ◆ *In the main part of the installation book, you will find a series of step-by-step procedures for each function available.*

The illustrations in the step-by-step procedures use three different symbols:

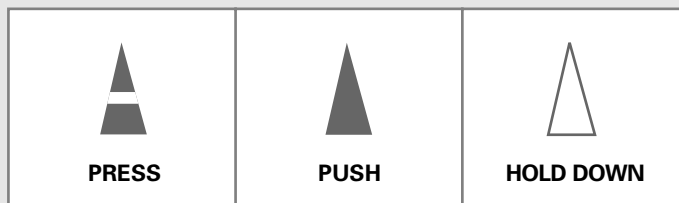

Inserting the Remote Control Batteries

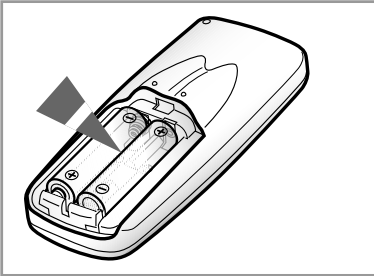
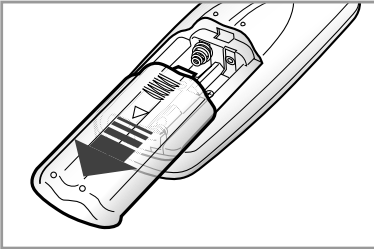

You must insert or replace the remote control batteries when :

- ◆ **You purchase the air conditioner**
- ◆ **The remote control does not work correctly**

Note

- ◆ Use two AAA, LR03 1.5V batteries.
- ◆ Do not use old batteries or different kinds of batteries together.
- ◆ Batteries may be completely discharged after 12 months, even if they have not actually been used.

- 1 Push the battery cover on the rear of the remote control with your thumb in the direction of the arrow and remove it.
- 2 Insert the two batteries, taking care to respect the polarities :
 - ◆ + on the battery with + on the remote control.
 - ◆ - on the battery with - on the remote control.
- 3 Close the cover by sliding it back until it clicks into place.

Installing the Remote Controller Holder

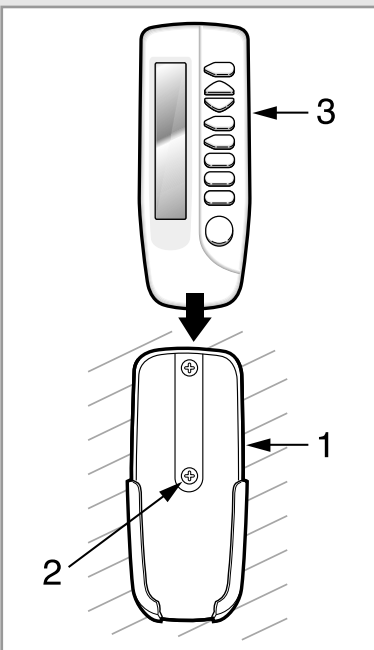







- 1 Place the remote controller holder on the wall.
- 2 Fix the remote controller holder by tightening the screws.
- 3 Put the remote controller into the holder as shown in the figure.
 - ◆ If you want to install the holder easily, you had better install the holder on the wooden frame.

5 Way Function

You can select the 5 Way function with operating mode of the air conditioner for more comfortable circumstances. You can use the 5 Way function with the indoor unit as well as the remote control. Thus, you can use this function even though you have lost your remote control.

Using with the indoor unit

- 1 Press the  (ON/OFF) button one time and then select the desired mode.

To obtain a(n)...	Then select...
Normal operating	 (STANDARD) mode
Reducing the uncomfortable temperature gradually	 (NATURE) mode
High fan speed	 (POWER) mode
Compressor run time reduced	 (SAVING) mode
Fan speed reduces as the temperature decreases	 (SILENCE) mode

- 2 To stop the operating, press the  (ON/OFF) button until all indicators turn off.

Note Even if the air conditioner has been turned on via the ON/OFF button on the unit, operations can still be controlled using the remote control as usual.

Selecting with the Remote Control

To select the 5 Way function with the remote control, press the 5 Way button one or more times until the desired mode is selected.

- ◆ Each time you press the 5 Way button:



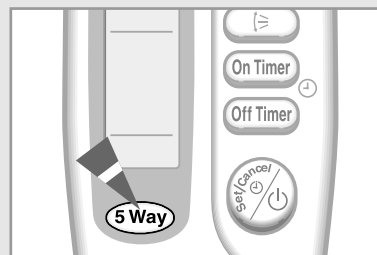
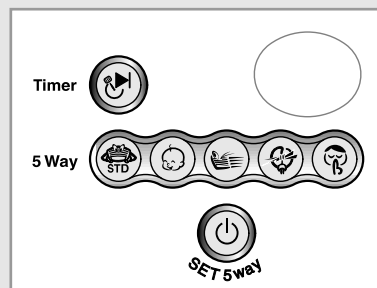

Each 5 Way indicator on the indoor unit lights up in order.

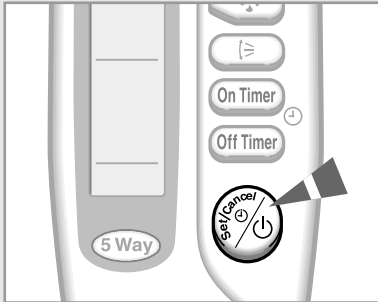

Selecting the Automatic Operating Mode

You can start the air conditioner in Automatic mode from your remote control. In the Automatic mode, the standard temperature and the optimum fan speed is selected automatically. You can adjust the standard temperature but not the fan speed.



- 1 If necessary, press the  (On/Off) button.

Result:

- ◆ The 5 Way indicator on the indoor unit lights up.
- ◆ The air conditioner starts up in the mode selected when the unit was last used.
- ◆ The indoor unit beeps.

IMPORTANT

The air conditioner is fitted with a protection mechanism to prevent the unit from being damaged when it is started immediately after being:

- ◆ Plugged in
- ◆ Stopped

It will start up normally after three minutes.

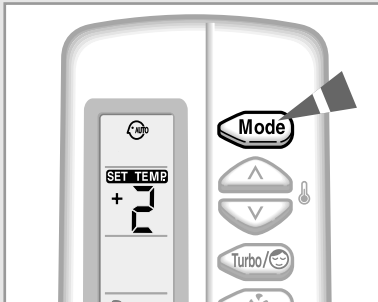

- 2 If the  is not displayed at the top of the remote control, press the MODE button on the remote control one or more times until it appears.

Result:

- ◆ The indoor unit beeps each time you press the MODE button.
- ◆ The air conditioner runs in AUTO mode.

Note

You can change modes at any time.

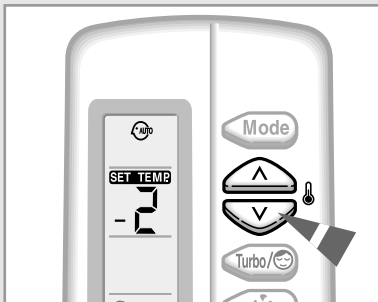

- 3 To adjust the standard temperature (The air conditioner automatically set the standard temperature by the current room temperature.), press the TEMPERATURE buttons one or more times.

SET TEMP.	SET TEMP.	-	SET TEMP.	SET TEMP.
-4°F/-2°C	-2°F/-1°C	Standard temperature	+2°F/+1°C	+4°F/+2°C
< When you feel hot >			< When you feel chilly >	

Cooling Your Room

You must select the Cool mode if you wish to adjust the:

- ◆ Cooling temperature
- ◆ Fan speed when cooling

1 If necessary, press the  (On/Off) button.

- Result:**
- ◆ The 5 Way indicator on the indoor unit lights up.
 - ◆ The air conditioner starts up in the mode selected when the unit was last used.
 - ◆ The indoor unit beeps.

IMPORTANT The air conditioner is fitted with a protection mechanism to prevent the unit from being damaged when it is started immediately after being:

- ◆ Plugged in
- ◆ Stopped

It will start up normally after three minutes.

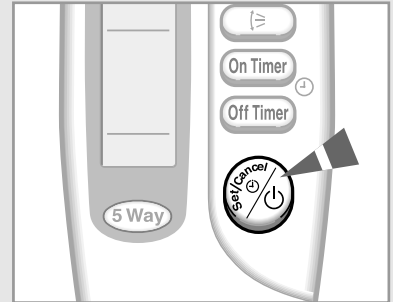

2 If the  is not displayed at the top of the remote control, press the MODE button on the remote control one or more times until it appears.

- Result:**
- ◆ The indoor unit beeps each time you press the MODE button.
 - ◆ The air conditioner runs in COOL mode.

Note You can change modes at any time.

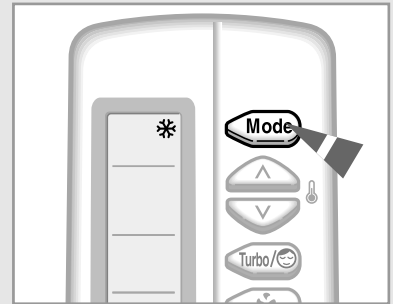



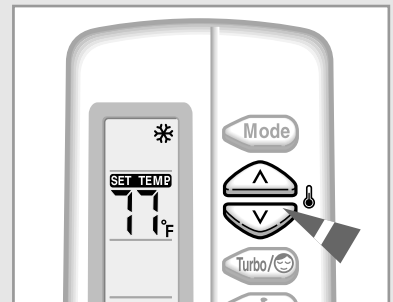

3 To adjust the temperature, press the TEMPERATURE buttons one or more times until the required temperature is displayed. Possible temperatures are between 65°F(18°C) and 86°F(30°C) inclusive.

- Result:**
- ◆ Each time you press the TEMPERATURE buttons:
 - The temperature is adjusted by 1°F(1°C)
 - The indoor unit beeps
 - ◆ The air conditioner starts cooling, provided that the room temperature is higher than the selected temperature; the fan will, however, operate.

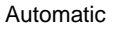

4 Select the fan speed by pressing the FAN button one or more times until the required setting is displayed:

-  Automatic (rotated : )
-  Low
-  Medium
-  High

Result: Each time you press the FAN button, the indoor unit beeps.

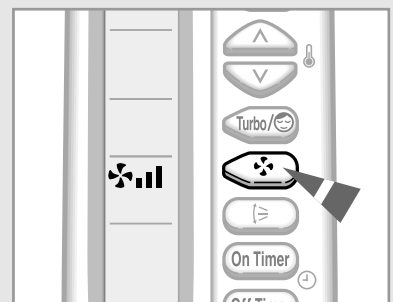

5 To control the direction of the air flow, refer to page 15.

Changing the Room Temperature Quickly

The Turbo cooling function is used to cool your room as quickly as possible.

Example : You have just come home and find that the room is very hot. You wish to cool it down as quickly as possible.

The Turbo function operates for 30 minutes with the maximum settings before returning automatically to the mode and temperature previously selected.

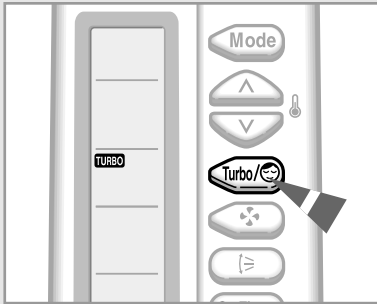

1 If necessary, press the  (On/Off) button.

Result:



- ◆ The 5 Way indicator on the indoor unit lights up.
- ◆ The air conditioner starts up in the mode selected when the unit was last used.
- ◆ The indoor unit beeps.

2 Press the  button.

Result:

- ◆ The temperature and fan settings are adjusted automatically.
- ◆ The air conditioner cools the room as quickly as possible.
- ◆ After 30 minutes, the air conditioner is reset automatically to the previous mode, temperature and fan settings.

But, if you press the  button in DRY or FAN mode, it will change to AUTO mode automatically.

3 If you wish to stop the Turbo function before the end of the 30-minute period, press the  button one or more times until **TURBO** or  disappears.

Result: The air conditioner is reset automatically to the previous mode, temperature and fan settings.

4 To control the direction of the air flow, refer to page 15.

Removing Excess Humidity

If the atmosphere in your room is very humid or damp, you can remove excess humidity without lowering the room temperature too much.

- 1 If necessary, press the  (On/Off) button.

Result:

- ◆ The 5 Way indicator on the indoor unit lights up.
- ◆ The air conditioner starts up in the mode selected when the unit was last used.
- ◆ The indoor unit beeps.

IMPORTANT The air conditioner is fitted with a protection mechanism to prevent the unit from being damaged when it is started immediately after being:

- ◆ Plugged in
- ◆ Stopped

It will start up normally after three minutes.

- 2 If the  is not displayed at the top of the remote control, press the MODE button on the remote control one or more times until it appears.

Result:

- ◆ The indoor unit beeps each time you press the MODE button.
- ◆ The air conditioner runs in DRY mode.

Note You can change modes at any time.

- 3 To adjust the temperature, press the TEMPERATURE buttons one or more times until the required temperature is displayed. Possible temperatures are between 65°F(18°C) and 86°F(30°C) inclusive.

Result:

- ◆ Each time you press the TEMPERATURE buttons:
 - The temperature is adjusted by 1°F(1°C)
 - The indoor unit beeps
- ◆ The air conditioner starts removing the excess humidity; the quantity of air is adjusted automatically.

- 4 To control the direction of the air flow, refer to page 15.

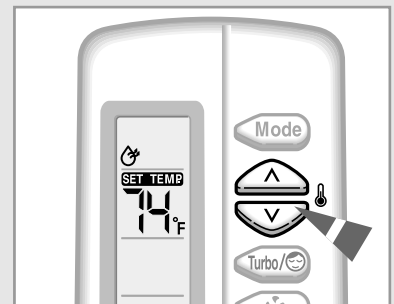
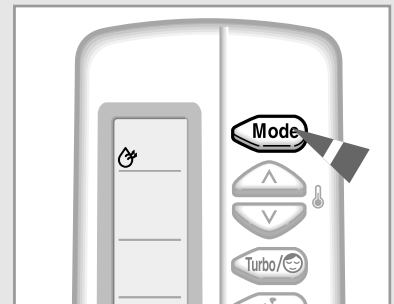
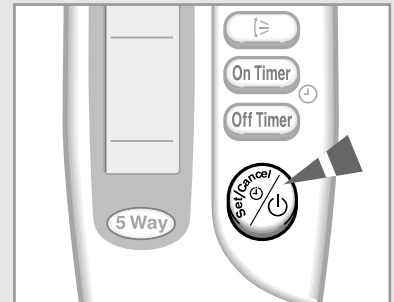

Airing Your Room

If the atmosphere in your room is stale, you can air the room using the Fan feature.

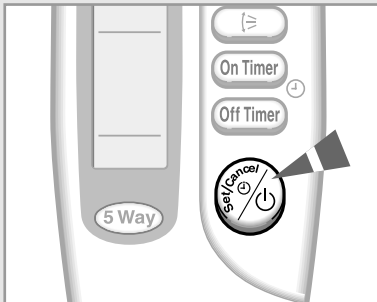

- 1 If necessary, press the  (On/Off) button.

Result:

- ◆ The 5 Way indicator on the indoor unit lights up.
- ◆ The air conditioner starts up in the mode selected when the unit was last used.
- ◆ The indoor unit beeps.

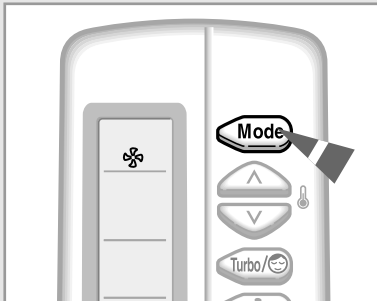

- 2 If the  is not displayed at the top of the remote control, press the MODE button on the remote control one or more times until it appears.



Result:

- ◆ The indoor unit beeps each time you press the MODE button.
- ◆ The air conditioner runs in FAN mode.
- ◆ The temperature is set automatically.

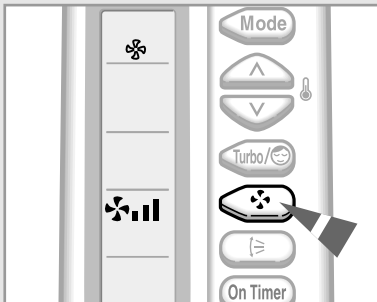
Note You can change modes at any time.



- 3 Select the fan speed by pressing the FAN button one or more times until the required setting is displayed:

-  Low
-  Medium
-  High

Result: Each time you press the FAN button, the indoor unit beeps.

- 4 To control the direction of the air flow, refer to page 15.

Adjusting the Air Flow Direction Vertically

Depending on the position of the indoor unit on the wall of your room, you can adjust the position of the outer air flow blade on the bottom of the unit, thus increasing the efficiency of the air conditioner.

- 1 Press the SWING button one or more times as required.

Result: The outer blade is adjusted vertically.

RECOMMENDATION	When...	Adjust the blade to face...
	Cooling	Upwards.

- 2 If you want the blade to move up and down automatically when the air conditioner is operating, press the SWING button.

Result: The blade move up and down, around the base position set.

- 3 To stop the blade moving up and down, press the SWING button again.

Note *If you switch the air conditioner... Then the blade is...*

Off	Closed completely.
On again	Set to the initial position powered.

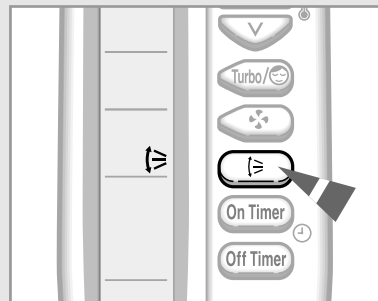

Adjusting the Air Flow Direction Horizontally

There are two sets of inner air flow blades. Just as the outer air flow blade can be adjusted vertically, the inner blades can be adjusted horizontally.

- 1 Adjust each set of inner blades to the required position, by pushing or pulling them sideways.

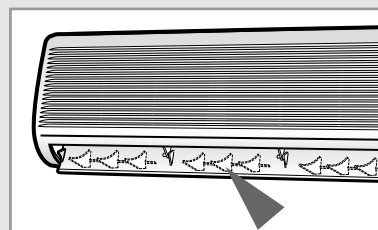

Setting the On Timer

The On Timer enables you to switch on the air conditioner automatically after a given period of time. You can set the period of time from 30 minutes to 24 hours.

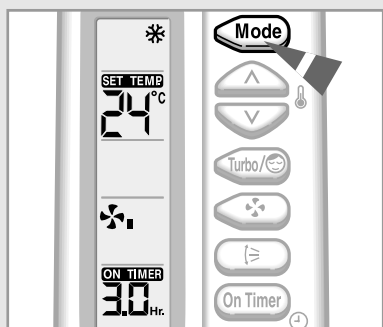
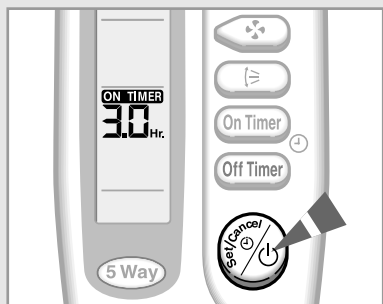

1 To set the operating time, press the ON TIMER button one or more times until the required time is displayed. Possible time is between 0.5 hour and 24 hour inclusive.

2 Press the  (Set/Cancel) button to complete the setting.

- Result:**
- ◆ The remaining time is displayed.
 - ◆ Blinking of the timer indicator stops.
 - ◆ The selected mode and the temperature on the display disappear after 10 seconds.
 - ◆ The air conditioner will switch on automatically when the counter displayed on the remote control reaches the set time and disappears the On timer setting.

3 To select an operating mode in advance, press the  button until the desired mode is displayed at the top of the remote control.

- Result:**
- ◆ The air conditioner will run in the selected mode when it is turned on.

To Cancel the On Timer

1 To cancel the On Timer, press the ON TIMER button one or more times until the timer setting disappears.

2 Press the  (Set/Cancel) button.

Note If you want to turn on the air conditioner before the timer reaches the setting time, press the  (ON/OFF) button.

Setting the Off Timer

The Off Timer enables you to switch off the air conditioner automatically after a given period of time. You can set the period of time from 30 minutes to 24 hours.



1 To set the operating time, press the OFF TIMER button one or more times until the required time is displayed. Possible time is between 0.5 hour and 24 hour inclusive.

2 Press the  (Set/Cancel) button to complete the setting.

Result:

- ◆ The remaining time is displayed.
- ◆ Blinking of the timer indicator stops.
- ◆ The air conditioner will switch off automatically when the counter displayed on the remote control reaches the set time and disappears the Off timer setting.

Example If you would like to turn the air conditioner on after 2 hours and to operate it for 2 hours:

1. Press the ON TIMER button until '2.0 Hr' is displayed.
2. Press the  (Set/Cancel) button.
3. Press the OFF TIMER button until '4.0 Hr' is displayed.
4. Press the  (Set/Cancel) button.

Note You can see or change the setting mode and/or the temperature by pressing the MODE button or the TEMPERATURE buttons after setting the Off timer.

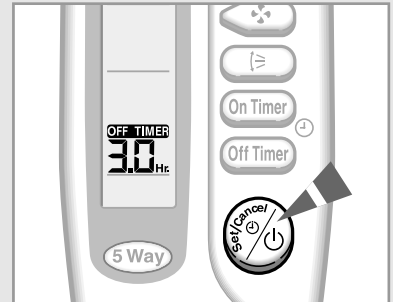
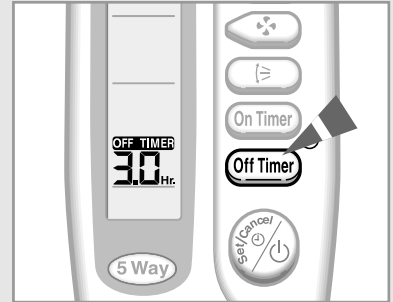

To Cancel the Off Timer

1 To cancel the Off Timer, press the OFF TIMER button one or more times until the timer setting disappears.

2 Press the  (Set/Cancel) button.

Note If you want to turn off the air conditioner before the timer reaches the setting time, press the  (ON/OFF) button.

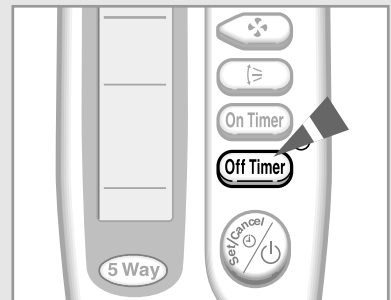



Setting the Sleep Timer

The Sleep Timer can be used when you are cooling your room to switch the air conditioner off automatically after a period of six hours.

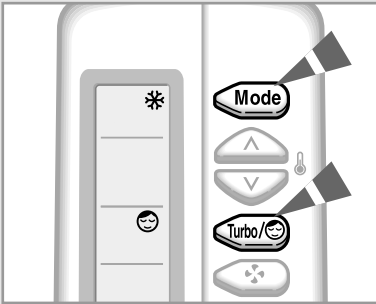
Note If you wish to switch the unit off at a specific time, refer to page 17.



1 Make sure that you have selected either COOL mode.

2 Press the  button one or more times until  appears on the remote control.

Result:

- ◆ The indoor unit beeps.
- ◆ The air conditioner will be controlled as indicated in the illustrations below.

Cooling The desired temperature is increased by 2°F/1°C every hour. When it has been increased by 4°F/2°C (after two hours), the temperature is maintained for four hours.

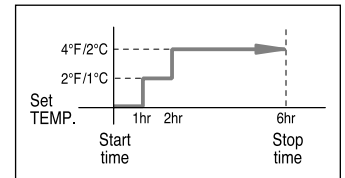

To Cancel the Sleep Timer

If you no longer wish to use the Sleep Timer that you have set, you can cancel it at any time.

Press the  button.

Result:

- ◆ The indoor unit beeps.
- ◆ The  is no longer displayed.
- ◆ The air conditioner operates normally.

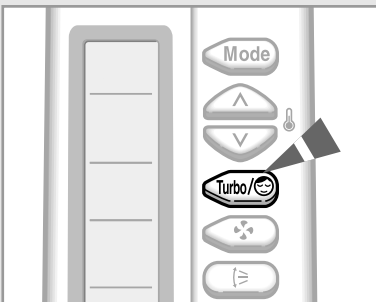

Operating Recommendations

Here are a few recommendations that you should follow when using your air conditioner.

Topic	Recommendation
Power failure	If a power failure occurs when the air conditioner is operating, the unit is switched off. When the power returns, you must press the  (ON/OFF) button to restart it.

Temperature and Humidity Ranges

The following table indicates the temperature and humidity ranges within which the air conditioner can be used.

If the air conditioner is used at...	Then...
High temperatures	The automatic protection feature may be triggered and the air conditioner stopped.
Low temperatures	A water leak or some other malfunction may occur if the heat exchanger freezes.
High humidity levels	Water may condense on and drip from the surface of the indoor unit if it is used for long periods.

Mode	Outdoor Temperature	Indoor Temperature	Indoor Humidity
Cooling	70°F to 109°F approx. 21°C to 43°C approx.	65°F to 90°F approx. 18°C to 32°C approx.	80% or less
Drying	65°F to 109°F approx. 18°C to 43°C approx.	65°F to 90°F approx. 18°C to 32°C approx.	-

※ ***If the cooling operation is used at over 92°F/33°C(indoor temperature) then, it does not cool as its full capacity.***

Cleaning Your Air Conditioner

To get the best possible use out of your air conditioner, you must clean it regularly to remove the dust that accumulates on the air filter.

IMPORTANT *Before cleaning your air conditioner, ensure that you have switched off the breaker used for the unit.*

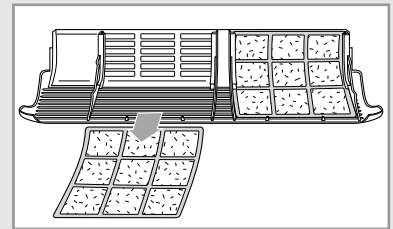
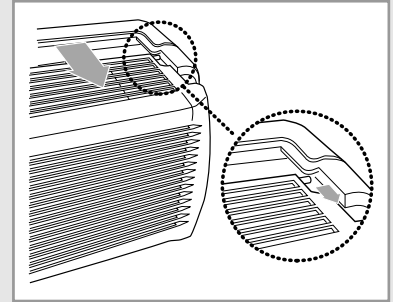

- 1 Open the front grille by lifting the tabs on the lower right and left sides of the indoor unit.
- 2 Disassemble the front grille by pulling it forwards.
- 3 Hold the edge of the air filter under the front grille and pull to release them.
- 4 Remove all dust on the air filters with a vacuum cleaner or brush.
- 5 Clean the front panel with a damp cloth and mild detergent (do NOT use benzene, solvents or other chemicals).
- 6 Reassemble the air filters and the front grille.

Note ♦ *If you have not used the air conditioner for a long period of time, set the fan going for three to four hours to dry the inside of the air conditioner thoroughly.*



Solving Common Problems

Before contacting the after-sales service, perform the following simple checks. They may save you the time and expense of an unnecessary call.

Problem	Explanation/Solution
The air conditioner does not operate at all	<ul style="list-style-type: none"> ◆ Check that the breaker used for the air conditioner is switched on. ◆ Check that the 5 Way indicator on the indoor unit is on; if necessary press the  (On/Off) button on the remote control. ◆ Check whether the TIMER indicator on the indoor unit is switched on. If so: <ul style="list-style-type: none"> - Wait until the switch-on time is reached and the air conditioner starts up automatically - Cancel the timer (see pages 16 and 17 for further details)
The air conditioner does not operate with the remote control	<ul style="list-style-type: none"> ◆ Check that there are no obstacles between you and the indoor unit. ◆ Check the remote control batteries. ◆ Check that you are close enough to the indoor unit (seven metres/yards/23ft. or less).
No beep is heard when you press the  (On/Off) on the remote control	<ul style="list-style-type: none"> ◆ Check that you are pointing the remote control at the remote control sensor in the right of the indoor unit. ◆ Replace the remote control batteries if necessary.
The air conditioner does not cool	<ul style="list-style-type: none"> ◆ Check that the correct operating mode has been selected (AUTO, COOL). ◆ The room temperature may be too low or too high. ◆ Dust may be blocking the air filter guard; refer to page 21 for cleaning instructions. ◆ Check that there is no obstacle in front of the outdoor unit.
The fan speed does not change when you press the FAN button	<ul style="list-style-type: none"> ◆ Check that the operating mode is set to COOL or FAN ; in the AUTO mode, the fan speed changes automatically and in the DRY mode, it is set to AUTO.
The air flow direction does not change when you press the SWING button	<ul style="list-style-type: none"> ◆ Check that the air conditioner has been switched on; if necessary, press the  (On/Off) button on the remote control.
The timer is not correctly triggered	<ul style="list-style-type: none"> ◆ Check that the timer has been programmed correctly; see pages 16 and 17.
Odours are permeated in the room during air conditioning	<ul style="list-style-type: none"> ◆ Air the room.

Installing a Filter (Option)

The air conditioner can be fitted with a deodorizing and Bio-Pure filter to remove minute dust particles or odours. The service life of the filter is approximately three months depending on the time during which the air conditioner is used.

- 1 Remove the vinyl packing from the filter.

Note Do not remove the packing from a deodorizing filter until you wish to use the filter, as it will lose its properties.

- 2 Insert the filter in the filter holder and press the three insert tabs until you hear a click.

- 3 Open the front grille by pulling on the tabs on the lower right and left sides of the indoor unit.

- 4 Take out the existing filter and replace it with the new one.

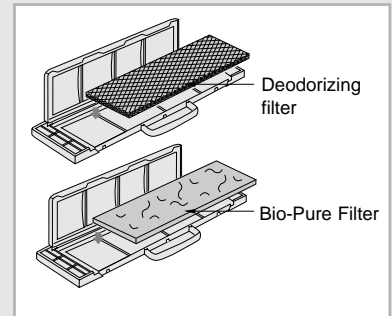

Technical Specifications

MODEL			Indoor unit	Outdoor unit	Indoor unit	Outdoor unit
			AM18B1C09	UM18B1C2	AM26B1C13	UM26B1C2
Type			2 Comp + 2 Room		2 Comp + 2 Room	
Performance Ratings	Capacity Cooling	Btu/h	A/B-Unit : 9000		A/B-Unit : 12500	
	SEER		10.0		10.0	
	Moisture Removal	Pts/h	3	-	4	-
	Air FLOW(Cooling, HIGH)	CFM	255	-	300	-
	Sound Rating-Outdoor	dB	-	57	-	60
Electrical Data	The number of operation		1 Unit operation	2 Unit operation	1 Unit operation	2 Unit operation
	Power source		208-230V~,60Hz		208-230V~,60Hz	
	Min.Ampacity	A	4.3	8.4	6.1	11.4
	Cooling Watts	W	990	1920	1360	2550
Refrigeration Lines	Indoor unit		A-Unit	B-Unit	A-Unit	B-Unit
	Connections		Flare		Flare	
	Liquid Line O. D.	mm(in)	6.35 (1/4)		6.35 (1/4)	
	Suction Line O.D.	mm(in)	9.52 (3/8)		12.70 (1/2)	
	Factory Pre-charge	m(ft)	5.0 (16½)		5.0 (16½)	
	Max. Line length	m(ft)	15.0 (49¼)		15.0 (49¼)	
	Max. Height Difference	m(ft)	7.0 (23)		7.0 (23)	
Dimensions & Weight	W X H X D	mm(in)	790 x 245 x 165 (31⅛ x 9½ x 6½)	880 x 638 x 310 (34½ x 25⅛ x 12¼)	790 x 245 x 165 (31⅛ x 9½ x 6½)	1000 x 790 x 310 (39½ x 31⅛ x 12¼)
	Net Weight	lbs	17	132.3	17	152.1

* Standard rating conditions Cooling

	Indoor		Outdoor	
	DB	WB	DB	WB
°F	80	67	95	75
°C	26.7	19.4	35.0	23.9

MODEL			Indoor unit	Indoor unit	Outdoor unit
			AM27B1C07	AM27B1C13	UM27B1C3
Type			2 Comp + 3 Room		
Performance Ratings	Capacity Cooling	Btu/h	A-Unit : 13000, B/C-Unit : 7000		
	SEER		10.0		
	Moisture Removal	Pts/h	2.5	4	-
	Air FLOW(Cooling, HIGH)	CFM	220	300	-
	Sound Rating-Outdoor	dB	-	-	62
Electrical Data	The number of operation		1 Unit operation	2 Unit operation	3 Unit operation
	Power source		208-230V~,60Hz		
	Min.Ampacity	A	A : 6.0, B(C) : 5.8	A+B(C) : 11.0, B+C : 6.2	A+B+C : 11.6
	Cooling Watts	W	A : 1350, B(C) : 1300	A+B(C) : 2450, B+C : 1380	A+B+C : 2580
Refrigeration Lines	Indoor unit		A-Unit	B-Unit	C-Unit
	Connections		Flare		
	Liquid Line O. D.	mm(in)	6.35 (1/4)		
	Suction Line O.D.	mm(in)	12.70(1/2)	9.52 (3/8)	
	Factory Pre-charge	m(ft)	5.0 (16 $\frac{1}{2}$)		
	Max. Line length	m(ft)	15.0 (49 $\frac{1}{4}$)		
	Max. Height Difference	m(ft)	7.0 (23)		
Dimensions & Weight	W X H X D	mm(in)	790 x 245 x 165 (31 $\frac{1}{8}$ x 9 $\frac{1}{2}$ x 6 $\frac{1}{2}$)		1000 x 790 x 310 (39 $\frac{1}{2}$ x 31 $\frac{1}{8}$ x 12 $\frac{1}{4}$)
	Net Weight	lbs	17		154.3

INSTALLATION MANUAL

Contents

- ◆ **PREPARING THE INSTALLATION**
 - Deciding on Where to Install the Air Conditioner 28
 - Air Conditioner and Accessories 32

- ◆ **INSTALLING THE INDOOR UNIT**
 - Fixing the Installation Plate 33
 - Purging the Unit 34
 - Connecting the Assembly Cable 35
 - Installing and Connecting the Indoor Unit Drain Hose 37
 - Installing and Connecting the Indoor Unit Assembly Piping . . 38
 - Cutting/Extending the Piping 39

- ◆ **INSTALLING THE OUTDOOR UNIT**
 - Connecting the Cables to the Outdoor Unit 40
 - Auxillary Circuit Breaker 42
 - Electrical Work 42
 - Checking Correct Earthing 43
 - Fixing the Unit in Position 44

- ◆ **COMPLETING THE INSTALLATION**
 - Connecting Up and Purging the Circuit 45
 - Performing Leak Tests 46
 - Placing the Indoor Unit in Position 47
 - Checking and Testing Operations 48
 - Explaining Operations to the Owner 49

Deciding on Where to Install the Air Conditioner

When deciding on the location of the air conditioner with the owner, the following restrictions must be taken into account.

General

Do NOT install the air conditioner in a location where it will come into contact with the following elements:

- ◆ Combustible gases
- ◆ Saline air
- ◆ Machine oil
- ◆ Sulphide gas
- ◆ Special environmental conditions

If you must install the unit in such conditions, first consult your dealer.

Indoor Unit

- ◆ There must be no obstacles near the air inlet and outlet.
- ◆ Install the indoor unit on a surface that can support its weight.
- ◆ Choose a position that enables the piping and cables to be easily connected to the outdoor unit and the recommended length of 5m (16ft. 5in) to be respected (15m (49ft. 3in) maximum).
- ◆ Leave enough clearance beneath the indoor unit to enable the filters to be removed without hindrance.
- ◆ Maintain sufficient clearance around the indoor unit, as indicated in the diagram on the page opposite.
- ◆ Make sure that the water dripping from the drain hose runs away correctly and safely.

Outdoor Unit

- ◆ The outdoor unit must NEVER be placed on its side or upside down, as the compressor lubrication oil will run into the cooling circuit and seriously damage the unit.
- ◆ Choose a location that is dry and sunny, but not exposed to direct sunlight or strong winds.
- ◆ Do not block any passageways or thoroughfares.
- ◆ Choose a location where the noise of the air conditioner when running and the discharged air do not disturb any neighbours.
- ◆ Choose a position that enables the piping and cables to be easily connected to the indoor unit and the recommended length of 5m (16ft. 5in) to be respected (15m (49ft. 3in) maximum).
- ◆ Install the outdoor unit on a flat, stable surface that can support its weight and does not generate any unnecessary noise and vibration.
- ◆ Position the outdoor unit so that the air flow is directed towards the outside, as indicated by the arrows on the top of the unit.
- ◆ Maintain sufficient clearance around the outdoor unit, as indicated in the diagram on the page opposite.
- ◆ If the outdoor unit is installed at a height, ensure that its base is firmly fixed in position; the maximum height is 7m (23ft).
- ◆ Make sure that the water dripping from the drain hose runs away correctly and safely.

CAUTION

- ◆ ***You have just purchased a split-type room air conditioner and it has been installed by your installation specialist.***
- ◆ ***This device must be installed according to the national electrical rules.***

► 18,000Btu/h

Indoor unit	Outdoor unit	Power supply Ø, V, Hz
AM18B1C09	UM18B1C2	1,208-230~,60

Respect the clearances and maximum lengths indicated in the diagram below when installing the unit.

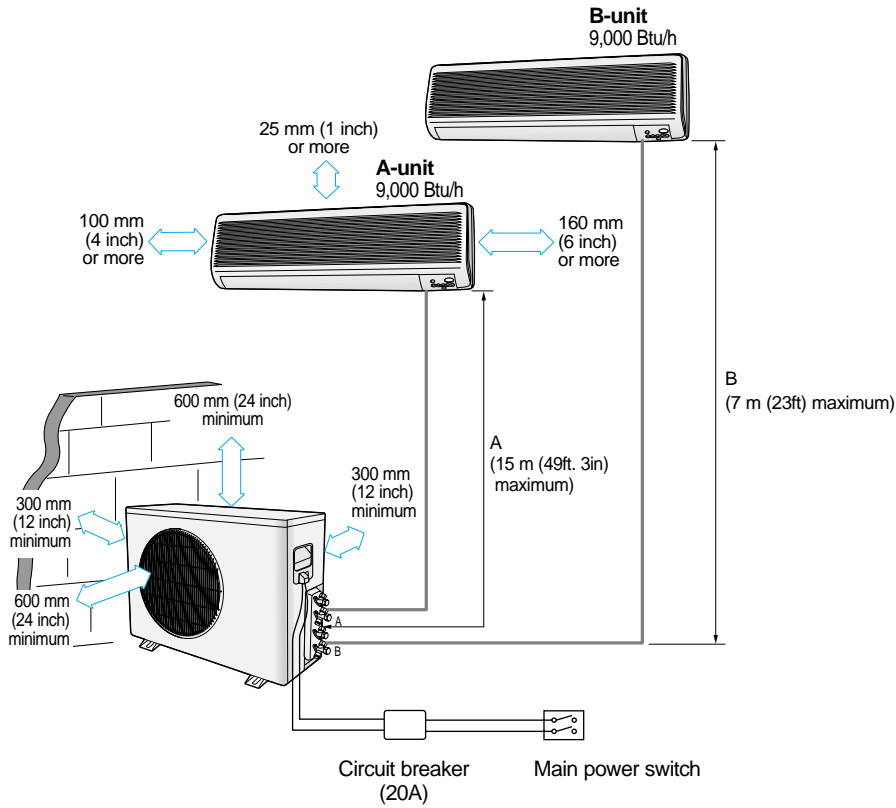

Piping length and the height.

Unit	Pipe size		MAX. piping length A	MAX. height B
	Liquid	GAS		
A-unit	1/4"	3/8"	15 m (49ft. 3in)	7 m (23ft)
B-unit	1/4"	3/8"	15 m (49ft. 3in)	7 m (23ft)

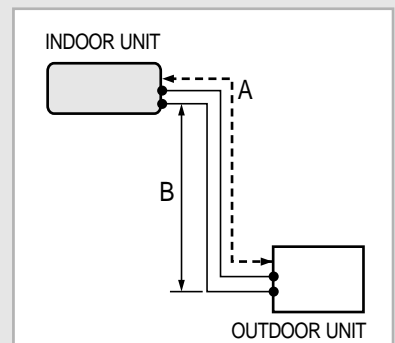

Deciding on Where to Install the Air Conditioner (cont.)

► 26,000Btu/h

Indoor unit	Outdoor unit	Power supply Ø, V, Hz
AM26B1C13	UM26B1C2	1,208-230-60

Respect the clearances and maximum lengths indicated in the diagram below when installing the unit.

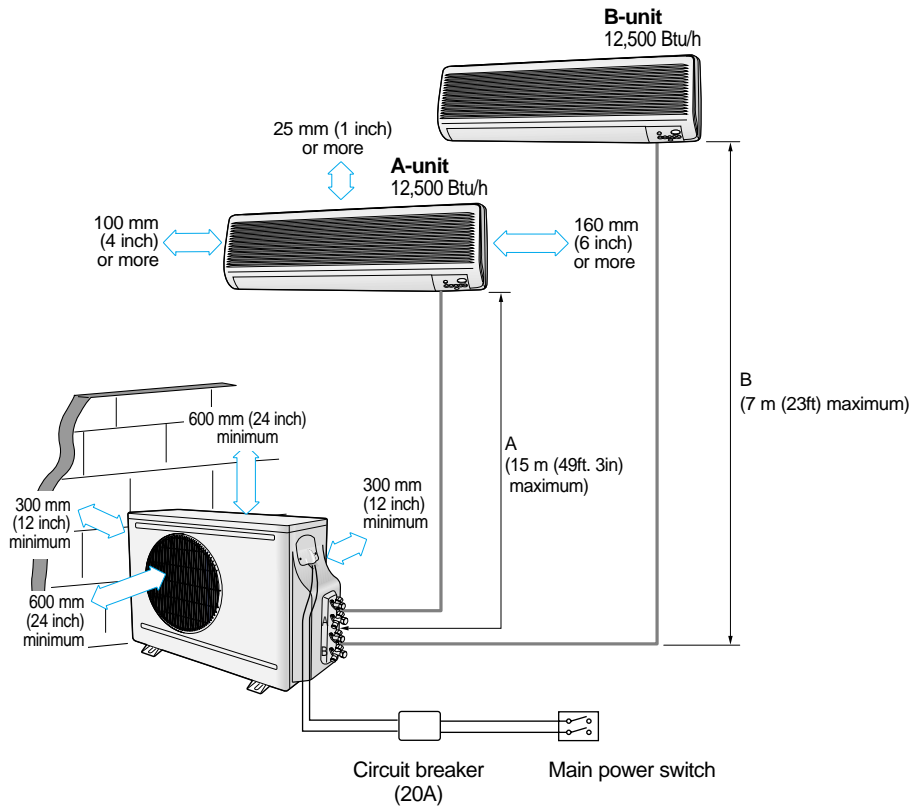

Piping length and the height.

Unit	Pipe size		MAX. piping length A	MAX. height B
	Liquid	GAS		
A-unit	1/4"	1/2"	15 m (49ft. 3in)	7 m (23ft)
B-unit	1/4"	1/2"	15 m (49ft. 3in)	7 m (23ft)

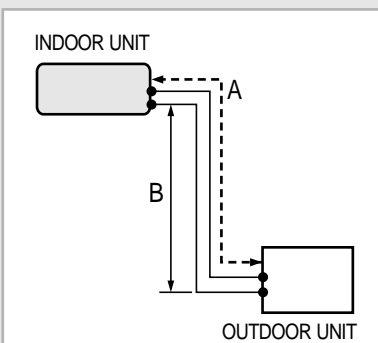

► 27,000Btu/h

Indoor unit	Outdoor unit	Power supply Ø, V, Hz
AM27B1C07 AM27B1C13	UM27B1C3	1,208-230~,60

Respect the clearances and maximum lengths indicated in the diagram below when installing the unit.

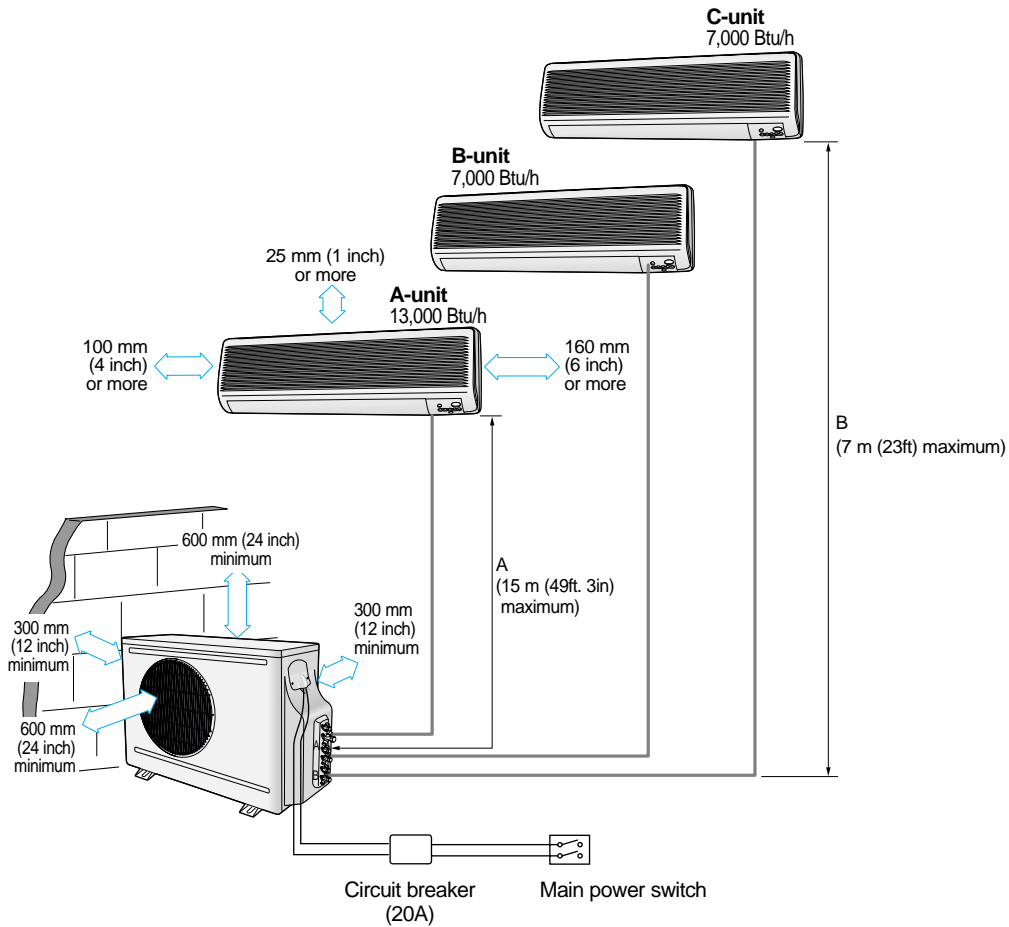

Piping length and the height.

Unit	Pipe size		MAX. piping length A	MAX. height B
	Liquid	GAS		
A-unit	1/4"	1/2"	15 m (49ft. 3in)	7 m (23ft)
B-unit	1/4"	3/8"	15 m (49ft. 3in)	7 m (23ft)
C-unit	1/4"	3/8"	15 m (49ft. 3in)	7 m (23ft)

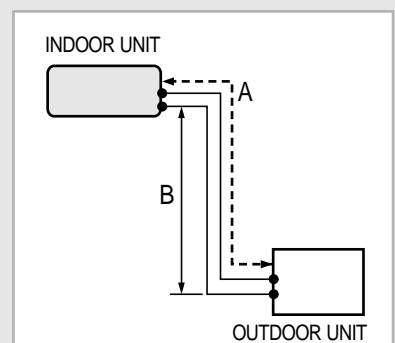

Air Conditioner and Accessories

The following accessories are supplied with the air conditioner.

➤ **The quantities are indicated in parentheses.**

Accessories in the Indoor Unit Case

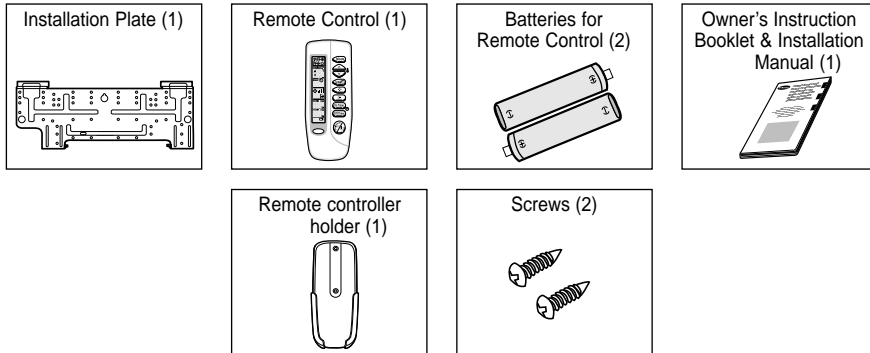

Accessories in the Outdoor Unit Case

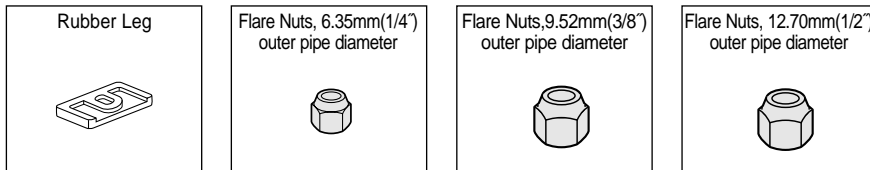

➤ **The assembly cable is depending on the option. [If they are not supplied, Using the standard cable.(approved according to IEC standard.)]**

Fixing the Installation Plate

Before fixing the installation plate to a wall or window frame, you must determine the position of the 65mm (2⁹/₁₆ inch) hole through which the cable, piping and hose pass to connect the indoor unit up to the outdoor unit. When facing the air conditioner in position on the wall, the piping and cable can be connected from the:

- ◆ **Right**
- ◆ **Left**
- ◆ **Rear (right or left)**

- 1 Determine the position of the pipe and drain hose hole using the right figure and drill the hole with an inner diameter of 65mm (2⁹/₁₆ inch) so that it slants slightly downwards.
-
- | 2 | If you are fixing the indoor unit to a... | Then follow Steps... |
|---|---|----------------------|
| | Wall | 3. |
| | Window frame | 4 to 6. |
-
- 3 Fix the installation plate to the wall in a manner appropriate to the weight of the indoor unit.
 - If you are mounting the plate on a concrete wall with anchor bolts, the anchor bolts must not project by more than 20mm (3/4 inch).
-
- 4 Determine the positions of the wooden uprights to be attached to the window frame.
-
- 5 Attach the wooden uprights to the window frame in a manner appropriate to the weight of the indoor unit.
-
- 6 Using tapped screws, attach the installation plate to the wooden uprights, as illustrated in the last figure opposite.

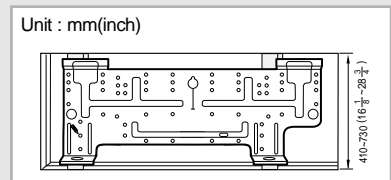
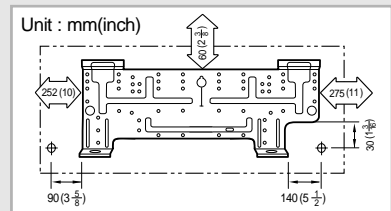
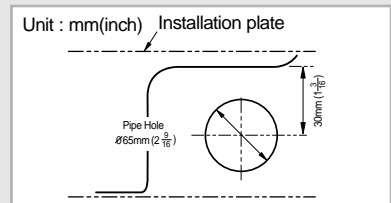
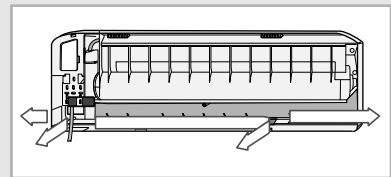

Purging the Unit

On delivery, the indoor unit is loaded with an inert gas. All this gas must therefore be purged before connecting the assembly piping. To purge the inert gas, proceed as follows.

Unscrew the caps at the end of each pipe.

Result: All inert gas escapes from the indoor unit.

- ***To prevent dirt or foreign objects from getting into the pipes during installation, do NOT remove the caps completely until you are ready to connect the piping.***

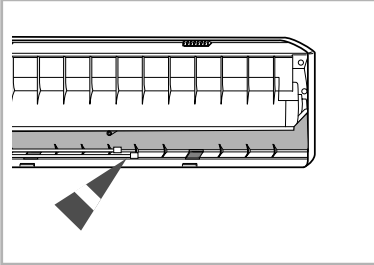

Connecting the Assembly Cable

**The outdoor unit is powered from the indoor unit via the assembly cable.
If the outdoor unit is more than 5m(16ft. 5in) away from the indoor unit, the
cable must first be extended to a maximum of 15m(49ft. 3in).**

- 1 Extend the assembly cable if necessary.
- 2 Open the front grille by pulling on the tabs on the lower right and left sides of the indoor unit; if necessary, refer to page 21.
- 3 Remove the screw securing the connector cover, then open the connector cover.
- 4 Remove three screws securing the front panel, then detach the front panel from the indoor unit.

※ The designs and shape are subject to change according to the model.

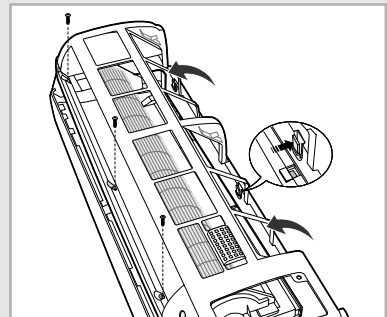
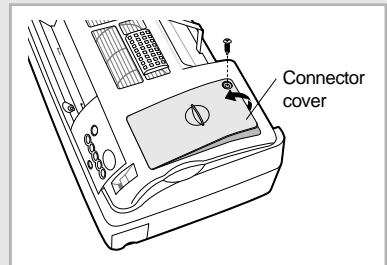

Connecting the Assembly Cable (cont.)

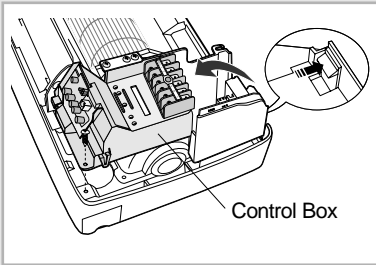

Control Box

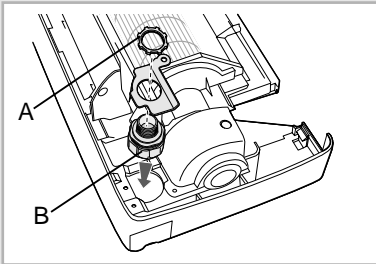

* The conduit kit is optional(A and B).

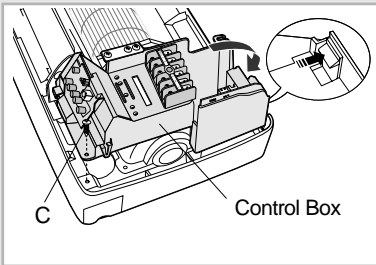

Control Box

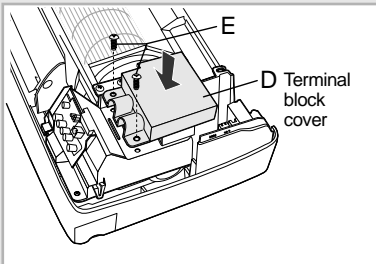

D Terminal block cover

- 5 Detach the control box from the indoor unit.

- 6 Install the conduit kit. (The conduit kit is optional)

- 7 Pass the assembly cable through the rear of the indoor unit and connect the assembly cable to terminals as shown in the figure.
 - > Each wire is labelled with the corresponding terminal number.

- 8 Pass the other end of the cable through the 65mm($2\frac{5}{16}$ inch) hole in the wall.

- 9 Reinstall the control box, then tighten the C screw.
 - > The C screw is provided with this manual.

- 10 Install the D terminal block cover, tightening the E screws.
 - > The D terminal block cover and E screws are provided with this manual.

- 11 Replace the front panel, carefully tightening the screws.

- 12 Reinstall the front grille.

- 13 For further details on how to plug the other end of the assembly cable into the outdoor unit, refer to pages 40 and 41.

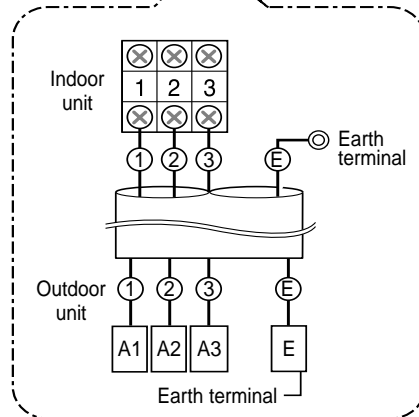
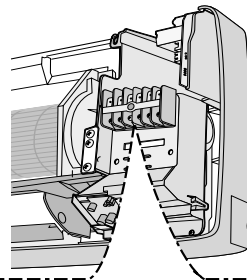

Installing and Connecting the Indoor Unit Drain Hose

Care must be taken when installing the drain hose for the indoor unit to ensure that any condensation water is correctly drained outside. When passing the drain hose through the 65mm (2 $\frac{9}{16}$ inch) hole drilled in the wall, check that none of the following situations occur.

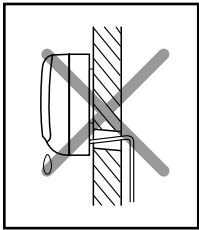

The hose must NOT slope upwards.

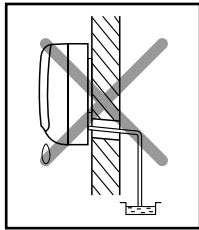

The end of the drain hose must NOT be placed in water.

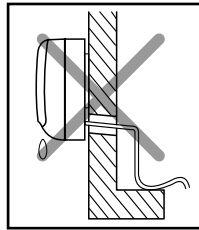

Do NOT bend the hose in different directions.

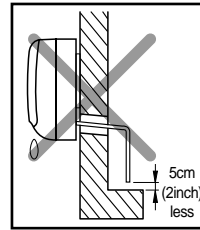

Keep a clearance of at least 5cm(2inch) between the end of the hose and the ground.

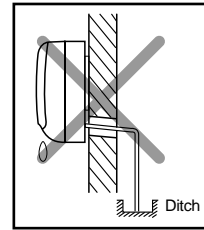

Do NOT place the end of the drain hose in a hollow.

To install the drain hose, proceed as follows.

- 1 If necessary, connect the 2m(6ft. 7in) extension to the drain hose.
- 2 If you are using the extension, insulate the inside part of the extension drain hose with a shield.
- 3 Pass the drain hose under the refrigerant piping, taking care to keep the drain hose tight.
- 4 Pass the drain hose through the hole in the wall, making sure that it is sloping downwards, as shown in the illustrations above.

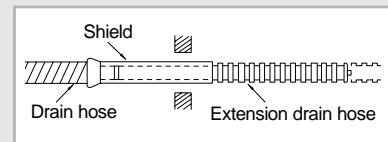

➤ **The hose will be fixed permanently into position once the whole installation has been tested for gas leaks; refer to page 47 for further details.**

Installing and Connecting the Indoor Unit Assembly Piping

There are two refrigerant pipes of different diameters:

- ◆ **A smaller one for the liquid refrigerant**
- ◆ **A larger one for the gas refrigerant**

A short length of piping is already fitted to the air conditioner. You must extend this piping using assembly piping (optionally supplied).

The connection procedure for the refrigerant piping varies according to the exit position of the piping from the indoor unit, as seen when facing the air conditioner in position on the wall:

- ◆ **Right (A)**
- ◆ **Left (B)**
- ◆ **Rear**

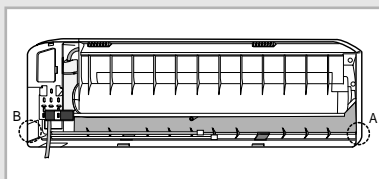

- 1 With a knife, cut out the appropriate knock-out piece on the rear of the indoor unit (unless you are connecting directly from the rear).

- 2 Smooth the cut edges.

- 3 Remove the protection caps on the pipes and connect the assembly piping to each pipe, tightening the nuts, first manually and then with a wrench, applying the following torque.

Pipe	Outer Diameter	Torque
Liquid refrigerant	6.35 mm(1/4")	160kg•cm(11.6ft•lb)
Gas refrigerant	9.52 mm(3/8")	300kg•cm(21.8ft•lb)
Gas refrigerant	12.70 mm(1/2")	500kg•cm(36.4ft•lb)

- If the piping must be shortened or extended, refer to page 39.

- 4 Cut off any excess foam insulation.

- 5 If necessary, bend the pipe round, along the bottom of the indoor unit and out through the appropriate hole, taking care to ensure that:
 - ◆ The piping does not jut out from the rear of the indoor unit
 - ◆ The bending radius is 100mm (4inch) or more

- 6 Pass the piping through the hole in the wall.

- 7 For further details on how to connect up to the outdoor unit and purge the circuit, refer to page 45.

- **The piping will be insulated and fixed permanently into position once the whole installation has been tested for gas leaks; refer to page 47 for further details.**

Cutting/Extending the Piping

5 metres(16ft. 5in) of piping is supplied with the air conditioner(Optional). This length can if necessary be:

- ◆ Extended to a maximum of 15m(49ft. 3in)
 - ◆ Shortened as required
- If more than 5m(16ft. 5in) of piping is required:
- ◆ The assembly cable must also be extended
 - ◆ Refrigerant must be added to the circuit by an approved installer; otherwise, the indoor unit may freeze

1 Make sure that you have the required tools available (pipe cutter, reamer, flaring tool and pipe holder).

2 If you wish to shorten the piping, cut it using a pipe cutter, taking care to ensure that the cut edge remains at a 90° angle with the side of the pipe, and referring to the illustrations below for examples of edges cut correctly and incorrectly.

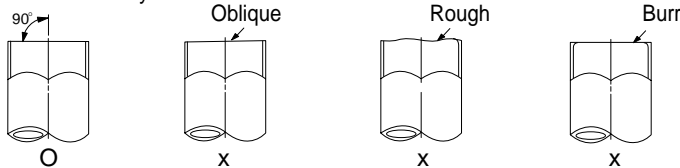

3 To prevent any gas from leaking out, remove all burrs at the cut end of the pipe, using a reamer.

4 Slide a flare nut on to the pipe and modify the flare.

Pipe	Outer Diameter (D)	Depth (A)
Liquid refrigerant	6.35 mm(1/4")	1.3 mm(1/16")
Gas refrigerant	9.52 mm(3/8")	1.8 mm(1/16")
Gas refrigerant	12.70 mm(1/2")	2.0 mm(1/16")

5 Check that the flaring is correct, referring to the illustrations below for examples of incorrect flaring.

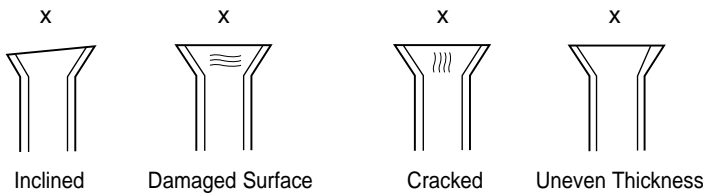

6 Align the pipes to be connected and tighten the flare nuts first manually and then with a wrench, applying the following torque.

Pipe	Outer Diameter	Torque
Liquid refrigerant	6.35 mm(1/4")	160kg•cm(11.6ft•lb)
Gas refrigerant	9.52 mm(3/8")	300kg•cm(21.8ft•lb)
Gas refrigerant	12.70 mm(1/2")	500kg•cm(36.4ft•lb)

7 For further details on how to connect up to the outdoor unit and purge the circuit, refer to page 45.

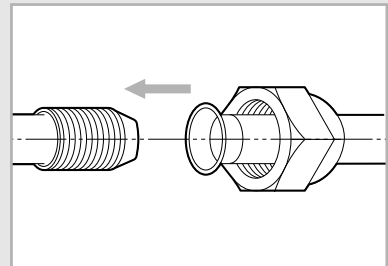
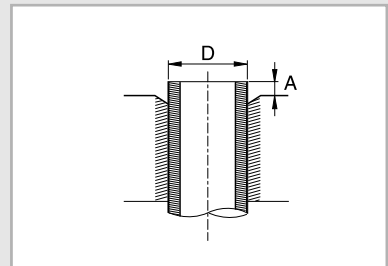
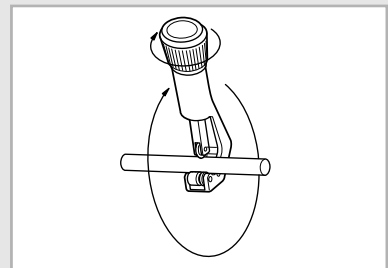

Connecting the Cables to the Outdoor Unit (cont.)

UM18B1C2

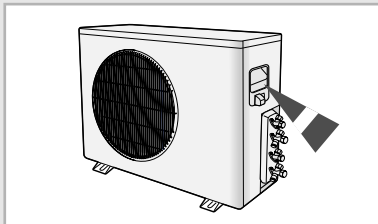

UM26B1C2

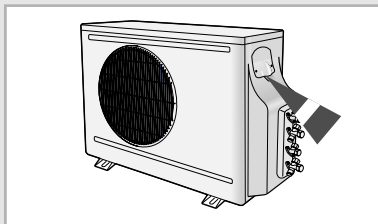

UM27B1C3

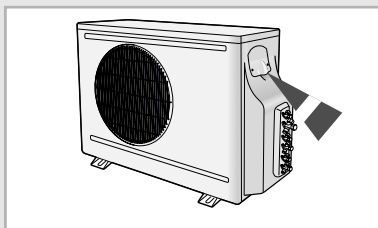

One electric cable must be connected to the outdoor unit:

◆ **The assembly cable connecting the indoor unit to the outdoor unit**

- 1 Remove the terminal board cover on the side of the outdoor unit.
-
- 2 Connect the assembly cable to terminals as shown in the figure.
 - Each wire is labelled with the corresponding terminal number.
-
- 3 Connect the earth wires to the earth terminals.
 - Refer to the page 43 for further details on how to check that earthing is correct.
-
- 4 Replace the terminal board cover, carefully tightening the screw.
-

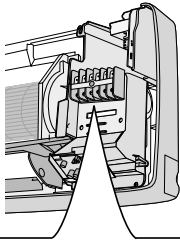

****18/26****

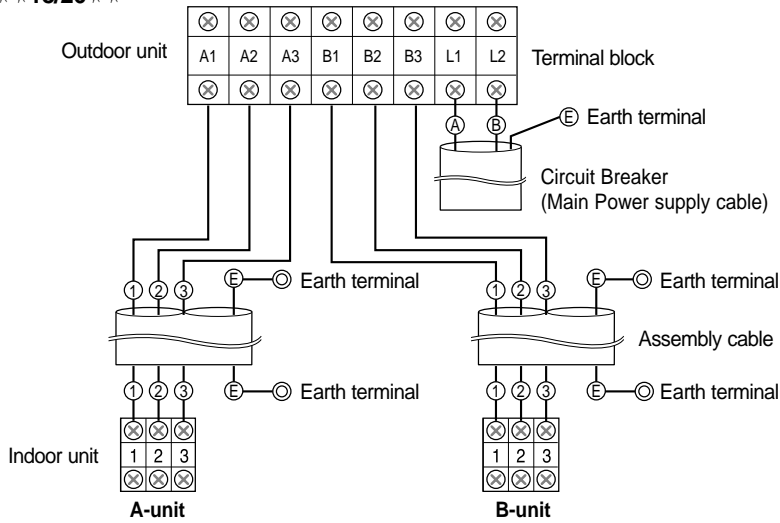

****27****

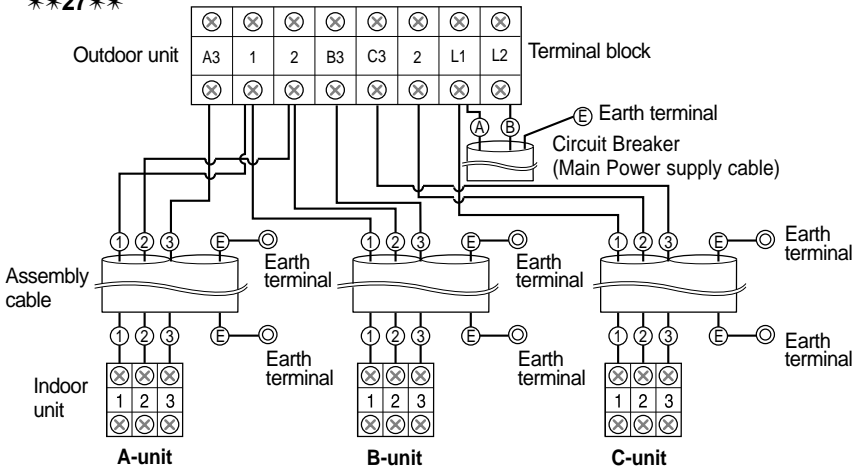

Auxiliary Circuit Breaker

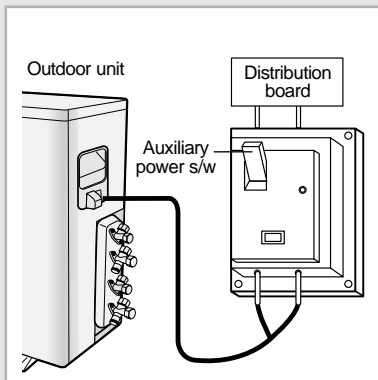

* The designs and shape are subject to change according to the model.

- ◆ *Auxiliary circuit breaker should be installed near outdoor unit so that each access is possible. Main/outdoor power supply cable are connected to upper/lower terminal of auxiliary circuit breaker.*
- ◆ *It is necessary that the conduit kit for power supply to the outdoor unit be installed between auxiliary power S/W and the outdoor unit. (the conduit kit is optional)*

Electrical Work

- 1 The supply voltage must be the same as the rated voltage of the air conditioner.
- 2 Prepare the power source for exclusive use with the air conditioner.
- 3 Use 20 amperes time delay fuse or circuit breaker.

MODEL	AM18B1C09	AM26B1C13	AM27B1C07 AM27B1C13
Power supply	208-230V~/60Hz		
Power cable	3G AWG 14		
Assembly cable	4G AWG 16		
Operating current	8.4A	11.4A	11.6A
Starting Current	22A	31A	31A
Power consumption	1920W	2550W	2580W

- When using the special NFB, use the NFB to bear the capacity of the air conditioner.
- Otherwise, the shot circuit in the NFB may occur.

Checking Correct Earthing

If the power distribution circuit does not have an earth or the earth does not comply with specifications, an earthing electrode must be installed. The corresponding accessories are not supplied with the air conditioner.

- 1 Select an earthing electrode that complies with the specifications given in the illustration opposite.

- 2 Determine a suitable location for the earthing electrode:
 - ◆ In damp hard soil rather than loose sandy or gravel soil that has a higher earthing resistance
 - ◆ Away from underground structures or facilities, such as gas pipes, water pipes, telephone lines and underground cables
 - ◆ At least 2m(6ft. 7in) away from a lightening conductor earthing electrode and its cable

➤ The earthing wire for the telephone line cannot be used to earth the air conditioner.

- 3 Dig a hole of the size indicated in the illustration opposite, drive the earthing electrode into position and cover the top of the electrode with the excavated soil.

- 4 Install a green/yellow insulated earthing wire ($\varnothing 1.6 \text{ mm} / \frac{1}{16}''$, section 2 mm^2 or greater):
 - ◆ If the earthing wire is too short, connect an extension lead, soldering the connection and wrapping it with insulating tape (do not bury the soldered connection)
 - ◆ Secure the earthing wire in position with staples

➤ If the earthing electrode is installed in an area of heavy traffic, its wire must be connected securely.

- 5 Carefully check the installation, by measuring the earthing resistance with an earthing resistance tester. If the resistance is above the required level, drive the earthing electrode deeper into the ground or increase the number of earthing electrodes.

- 6 Connect the earthing wire to the earthing screw on the air conditioner.

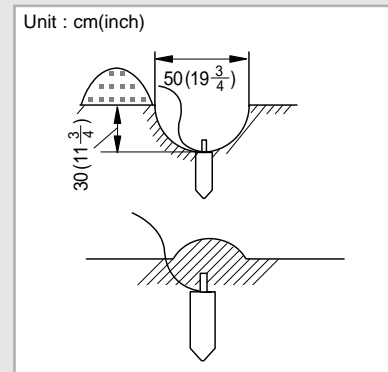
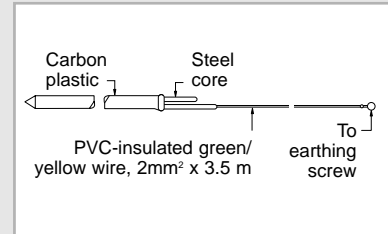

Fixing the Unit in Position

Unit : mm(inch)

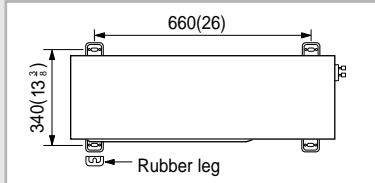

The outdoor unit must be installed on a rigid and stable base to avoid any increase in the noise level and vibration, particularly if the outdoor unit is to be installed close to a neighbour. If it is to be installed in a location exposed to strong winds or at a height, the unit must be fixed to an appropriate support (wall or ground).

- 1 Position the outdoor unit so that the air flow is directed towards the outside, as indicated by the arrows on the top of the unit.
- 2 Attach the outdoor unit to the appropriate support using anchor bolts.
- 3 If the outdoor unit is exposed to strong winds, install shield plates around the outdoor unit, so that the fan can operate correctly.

* Certainly fix up its rubber leg, in order to prevent its vibration and noise.

Connecting Up and Purging the Circuit

The outdoor unit is loaded with sufficient R22 refrigerant for 5m(16ft. 5in) of piping. The air in the indoor unit and in the pipe must be purged. If air remains in the refrigeration pipes, it will affect the compressor, reduce to cooling capacity and could lead to a malfunction. Refrigerant for air purging is not charged in the outdoor unit. Use Vacuum Pump as shown at the figure.

- 1 Connect each assembly pipe to the appropriate valve on the outdoor unit and tighten the flare nut.

- 2 Referring to the illustration opposite, tighten the flare nut first manually and then with a wrench, applying the following torque.

Pipe	Outer Diameter	Torque
Liquid refrigerant	6.35 mm(1/4")	160kg•cm(11.6ft•lb)
Gas refrigerant	9.52 mm(3/8")	300kg•cm(21.8ft•lb)
Gas refrigerant	12.70 mm(1/2")	500kg•cm(36.4ft•lb)

- 3 Connect the charging hose of low pressure side of manifold gauge to the packed valve having a service port as shown at the figure.

- 4 Open the valve of the low pressure side of manifold gauge counterclockwise.

- 5 Purge the air from the system using vacuum pump for about 10 minutes.
 - Close the valve of the low pressure side of manifold gauge clockwise.
 - Make sure that pressure gauge show -0.1MPa(-76cmHg) after about 10minutes.
 This procedure is very important in order to avoid gas leak.
 - Turn off the vacuum pump
 - Remove the hose of the low pressure side of manifold gauge.

- 6 Set valve cork of both liquid side and gas side of packed valve to the open position.

- 7 Mount the valve stem nuts and the service port cap to the valve, and tighten them at the torque of 18N•m with a torque wrench.

- 8 Check for gas leakage.
 - At this time, especially check for gas leakage from the 3-way valve's stem nuts, and from the service port cap.

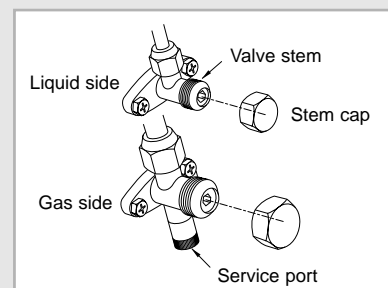
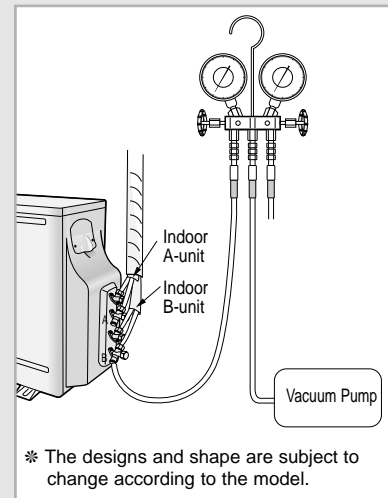
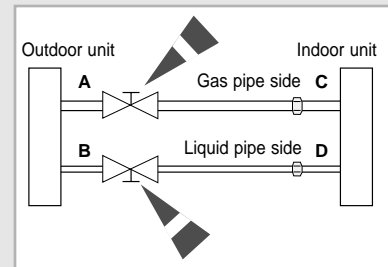

You can install 15m of connecting pipe to the maximum, and you don't have to charge any additional refrigerant.

Performing Leak Tests

Before completing the installation (insulation of the cables, hose and piping and fixing of the indoor unit to the installation plate), you must check that there are no gas leaks.

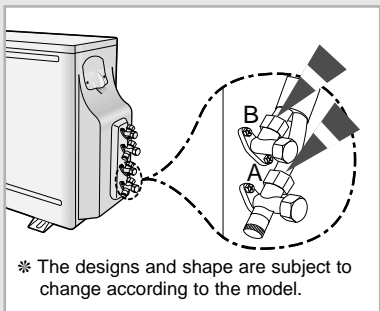
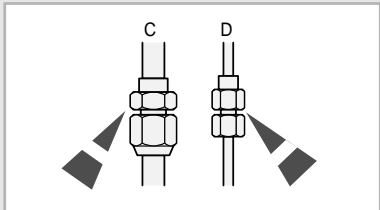

* The designs and shape are subject to change according to the model.

To check for gas leaks on the...	Then, using a leak detector, check the...
Indoor unit	Flare nuts at the end of sections C and D.
Outdoor unit	Valves on sections A and B.

Placing the Indoor Unit in Position

Once you have checked that there are no leaks in the system, you can insulate the piping, hose and cables and place the indoor unit on the installation plate.

- 1 To avoid condensation problems, place heat-resistant polyethylene foam separately around each refrigerant pipe in the lower part of the indoor unit.

- 2 Wrap the refrigerant pipes and the drain hose located at the rear of the indoor unit up in the absorbent pad.
 - Triply wind the pipes and hose to the end of the indoor unit with the absorbent pad (make intervals of 20mm / $\frac{3}{4}$ inch).

- 3 Wind insulating tape around the pipes, assembly cable and drain hose.

- 4 Place the resulting bundle carefully in the lower part of the indoor unit, making sure that it does not jut out from the rear of the indoor unit.

- 5 Hook the indoor unit on to the installation plate and move the unit to the right and left until you are sure that it is securely in place.

- 6 Finish wrapping vinyl tape around the rest of the piping leading to the outdoor unit.

- 7 Using clamps (optionally supplied), attach the piping to the wall wherever possible.

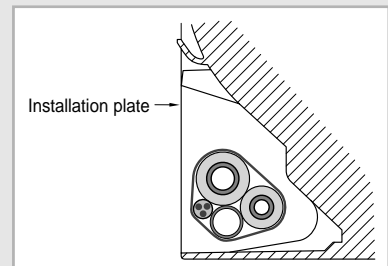
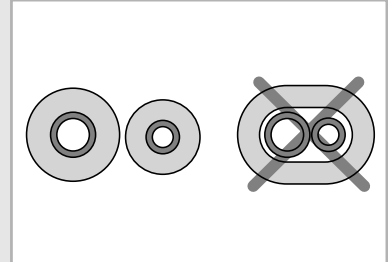

Checking and Testing Operations

To complete the installation, perform the following checks and tests to ensure that the air conditioner is operating correctly.

- 1 Review all the following elements in the installation:
 - ◆ Installation site strength
 - ◆ Piping connection tightness to detect any gas leakages
 - ◆ Connection wiring
 - ◆ Heat-resistant insulation of the piping
 - ◆ Drainage
 - ◆ Earthing wire connection
 - ◆ Correct operations (follow the steps below)
-
- 2 Press the On/Off button.

Result:

 - ◆ The indicator lights on the indoor unit flash at half-second intervals.
 - ◆ While the indoor unit opens, the indoor unit fan runs to start.
-

- 3 Press the  button.

Result: The outdoor unit operates in cooling mode as following the room temperature.
-

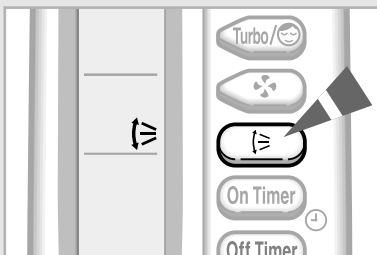

- 4 Air flow direction Press the  button and check that the air flow blades work properly.
-

Explaining Operations to the Owner

Before leaving the premises on which you have installed the air conditioner, you should explain the following operations to the owner, making reference to the appropriate pages in the owner's instruction booklet.

- 1 How to start and stop the air conditioner.

- 2 How to select the operating mode and adjust the temperature and fan settings.

- 3 How to adjust the air flow direction.

- 4 How to set the timers.

- 5 How to remove and clean the filters.

Once the owner is happy with the basic operations, hand over the owner's instruction booklet and this installation manual for storage in a handy and safe place.

**THIS AIR CONDITIONER IS MANUFACTURED BY:
ESTE AIRE ACONDICIONADO HA SIDO FABRICADO POR:
CE CLIMATISEUR EST FABRIQUE PAR:**



ELECTRONICS