

Home Theatre System

Operating Instructions

Owner's Record

The model and serial numbers are located on the rear of the unit. Record the serial number in the space provided below. Refer to them whenever you call upon your Sony dealer regarding this product.

Model No. _____ Serial No. _____

HT-DDW760

WARNING

To prevent fire or shock hazard, do not expose the unit to rain or moisture.

To prevent fire, do not cover the ventilation of the apparatus with newspapers, table-cloths, curtains, etc. And don't place lighted candles on the apparatus.

To prevent fire or shock hazard, do not place objects filled with liquids, such as vases, on the apparatus.

Do not install the appliance in a confined space, such as a bookcase or built-in cabinet.



Don't throw away batteries with general house waste; dispose of them correctly as chemical waste.

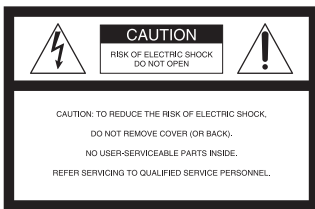

This symbol is intended to alert the user to the presence of uninsulated "dangerous voltage" within the product's enclosure that may be of sufficient magnitude to constitute a risk of electric shock to persons.



This symbol is intended to alert the user to the presence of important operating and maintenance (servicing) instructions in the literature accompanying the appliance.

WARNING

This equipment has been tested and found to comply with the limits for a Class B digital device, pursuant to Part 15 of the FCC Rules. These limits are designed to provide reasonable protection against harmful interference in a residential installation. This equipment generates, uses, and can radiate radio frequency energy and, if not installed and used in accordance with the instructions, may cause harmful interference to radio communications. However, there is no guarantee that interference will not occur in a particular installation. If this equipment does cause harmful interference to radio or television reception, which can be determined by turning the equipment off and on, the user is encouraged to try to correct the interference by one or more of the following measures:

- Reorient or relocate the receiving antenna.
- Increase the separation between the equipment and receiver.
- Connect the equipment into an outlet on a circuit different from that to which the receiver is connected.
- Consult the dealer or an experienced radio/TV technician for help.

CAUTION

You are cautioned that any changes or modification not expressly approved in this manual could void your authority to operate this equipment.

Note to CATV system installer:

This reminder is provided to call CATV system installer's attention to Article 820-40 of the NEC that provides guidelines for proper grounding and, in particular, specifies that the cable ground shall be connected to the grounding system of the building, as close to the point of cable entry as practical.



ENERGY STAR[®] is a U.S. registered mark. As an ENERGY STAR[®] partner, Sony Corporation has determined that this product meets the ENERGY STAR[®] guidelines for energy efficiency.

About This Manual

- The instructions in this manual are for model HT-DDW760. Check your model number by looking at the lower right corner of the front panel.
- The instructions in this manual describe the controls on the receiver. You can also use the controls on the supplied remote if they have the same or similar names as those on the receiver. For details on the use of your remote, see pages 31–34.

The HT-DDW760 consists of:

- Receiver STR-K760P
- Speaker system
 - Front speaker (left) SS-MSP760L
 - Front speaker (right) SS-MSP760R
 - Center speaker SS-CNP760
 - Surround speaker (left) SS-MSP760SL
 - Surround speaker (right) SS-MSP760SR
 - Sub woofer SA-WMSP76

This receiver incorporates Dolby* Digital and Pro Logic Surround and the DTS** Digital Surround System.

* Manufactured under license from Dolby Laboratories.

“Dolby”, “Pro Logic” and the double-D symbol are trademarks of Dolby Laboratories.

** “DTS” and “DTS Digital Surround” are registered trademarks of Digital Theater Systems, Inc.

Table of Contents

Getting Started

1: Check how to hookup your components	5
1a: Connecting components with digital audio output jacks	7
1b: Connecting components with only analog audio jacks	9
2: Connecting the antennas	11
3: Connecting speakers	12
4: Connecting the AC power cord	14
5: Setting up the speakers	15
6: Setting up the sub woofer	16
7: Adjusting the speaker levels and balance	17
— TEST TONE	

Amplifier Operation

Selecting the component	18
Listening to FM/AM radio	18
Presetting radio stations	19
Changing the display	20
About the indications in the display	21

Enjoying Surround Sound

Using only the front speakers and sub woofer	22
— 2CH STEREO	
Enjoying higher fidelity sound	22
— AUTO FORMAT DIRECT	
Selecting a sound field	23

Advanced Adjustments and Settings

Switching the audio input mode for digital components	25
— INPUT MODE	
Customizing sound fields	25
Adjusting the tone	27
Advanced settings	27

Other Operations

Naming preset stations and inputs	29
Using the Sleep Timer	29
Recording	30

Operations Using the Remote RM-U755

Before you use your remote	31
Remote button description	31
Changing the factory setting of an input button	34

Additional Information

Precautions	35
Troubleshooting	36
Specifications	38
List of button locations and reference pages	40
Index	42

1: Check how to hookup your components

Steps 1a through 1b beginning on page 7 describe how to hook up your components to this receiver. Before you begin, refer to “Connectable components” below for the pages which describe how to connect each component.

After hooking up all your components, proceed to “2: Connecting the antennas” (page 11).

Connectable components

Component to be connected	Page
DVD player	
With digital audio output ^{a)}	7–8
With analog audio output only ^{b)}	7–8
TV monitor	
With composite video input only	8 or 10
Satellite tuner	
With digital audio output ^{a)}	7–8
With analog audio output only ^{b)}	7–8
CD player	
With analog audio output only ^{b)}	9
MD/Tape deck	
With analog audio output only ^{b)}	9
VCR	10

a) Model with a DIGITAL OPTICAL OUTPUT or DIGITAL COAXIAL OUTPUT jack, etc.

b) Model equipped only with AUDIO OUT L/R jacks, etc.

Required cords

The hookup diagrams on the subsequent pages assume the use of the following optional connection cords (**A** to **E**) (not supplied unless indicated).

A Audio cord

White (L)
Red (R)

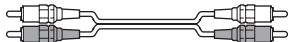

B Audio/video cord

Yellow (video)
White (L/audio)
Red (R/audio)



C Video cord

Yellow



D Optical digital cord



E Coaxial digital cord (supplied)

Orange



Notes

- Turn off the power to all components before making any connections.
- Be sure to make connections firmly to avoid hum and noise.
- When connecting an audio/video cord, be sure to match the color-coded pins to the appropriate jacks on the components: yellow (video) to yellow; white (left, audio) to white; and red (right, audio) to red.
- When connecting optical digital cords, insert the cord plugs straight in until they click into place.
- Do not bend or tie optical digital cords.

1a: Connecting components with digital audio output jacks

Hooking up a DVD player or satellite tuner

For details on the required cords (**A-E**), see page 6.

1 Connect the audio jacks.

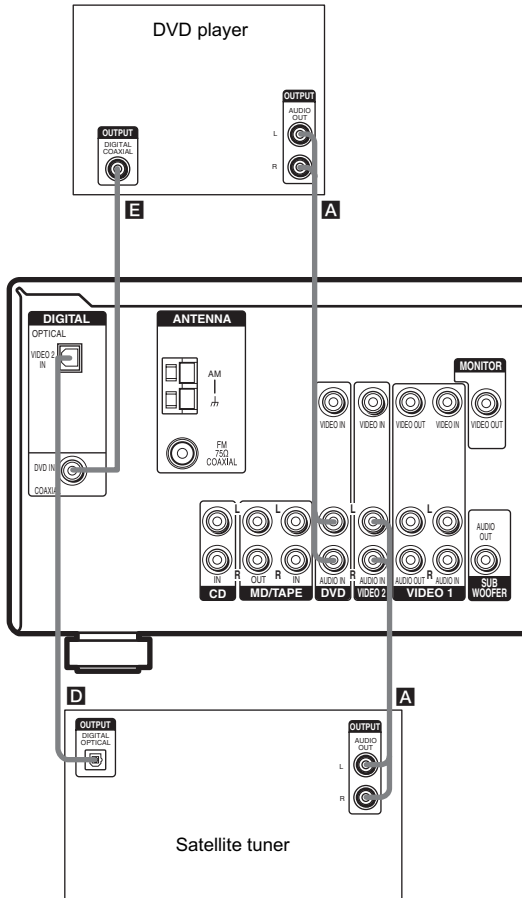

Note

You can also listen to the sound of your TV by connecting your TV's audio output jacks to the VIDEO 2 AUDIO IN jacks on the receiver. In this case, do not connect the TV's video output jack to the VIDEO 2 VIDEO IN jack on the receiver.

2 Connect the video jacks.

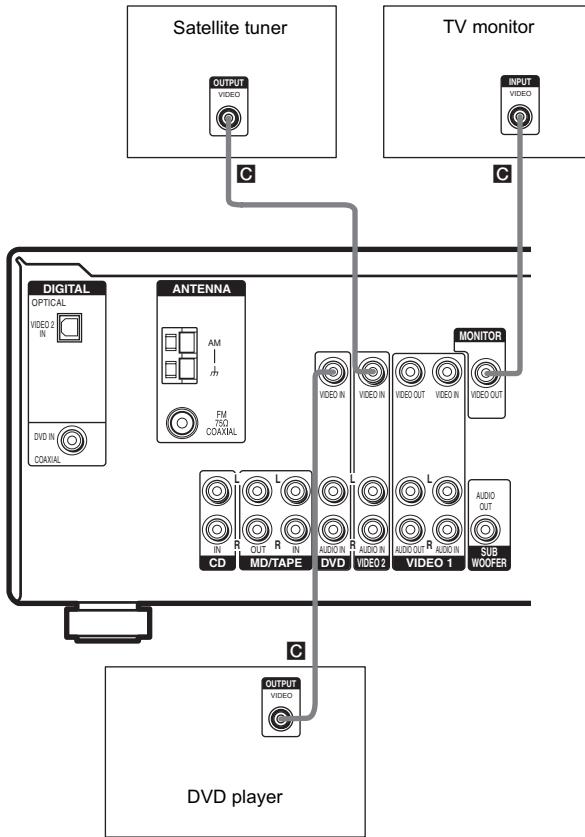

1b: Connecting components with only analog audio jacks

Hooking up audio components

For details on the required cords (**A-E**), see page 6.

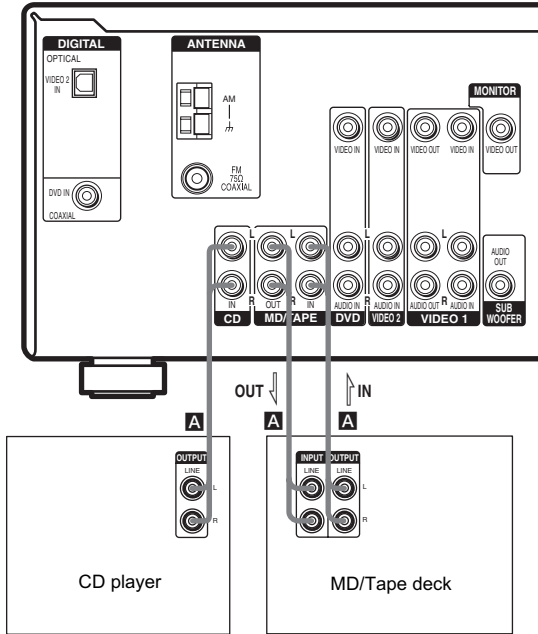

Hooking up video components

If you connect your TV to the MONITOR VIDEO OUT jack, you can watch the video from the selected input (page 18). For details on the required cords (**A–E**), see page 6.

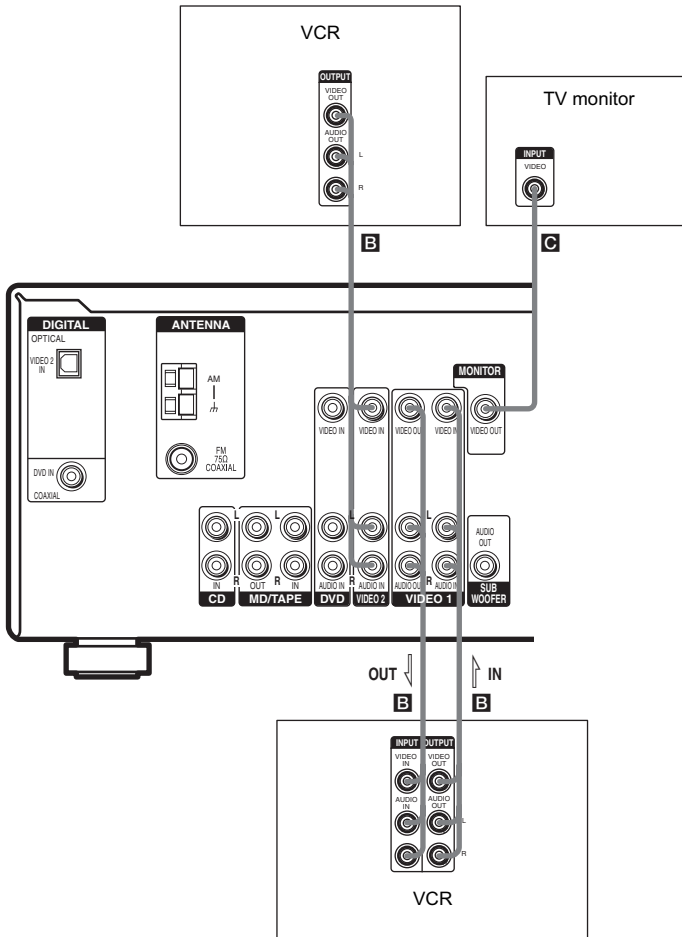

2: Connecting the antennas

Connect the supplied AM loop antenna and FM wire antenna.

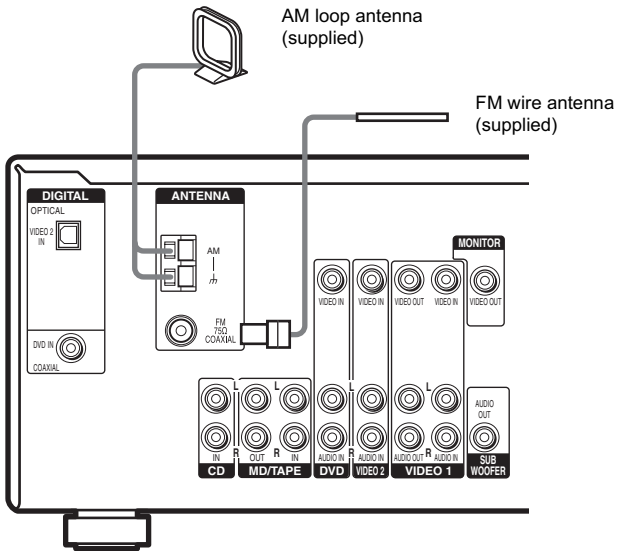

Notes

- To prevent noise pickup, keep the AM loop antenna away from the receiver and other components.
- Be sure to fully extend the FM wire antenna.
- After connecting the FM wire antenna, keep it as horizontal as possible.

3: Connecting speakers

Connect your speakers to the receiver. This receiver allows you to use a 5.1 channel speaker system. To fully enjoy theater-like multi channel surround sound requires five speakers (two front speakers, a center speaker, and two surround speakers) and a sub woofer (5.1 channel).

Example of 5.1 channel speaker system configuration

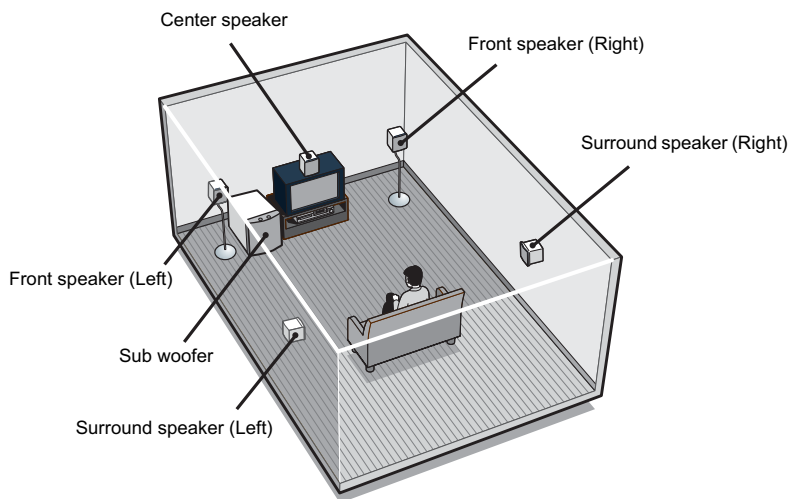

Tips

- Since the sub woofer does not emit highly directional signals, you can place it wherever you want.
- For greater flexibility in the positioning of the speakers, use the optional WS-FV11 or WS-FV10D floor stand (available only in certain countries).

Note

Connect the long speaker connecting cords to the surround speaker terminals and the short speaker connecting cords to the front and center speaker terminals.

Attaching foot pads

To prevent speaker vibration or movement, attach the supplied foot pads to the speaker as shown in the illustration below.

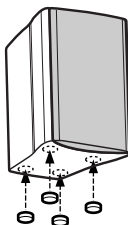

Note

Be sure to attach the supplied foot pads to the sub woofer as well.

Required cords

A Speaker cords (supplied)

(+)
(-)

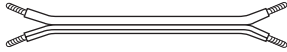

B Monaural audio cord (supplied)

Black

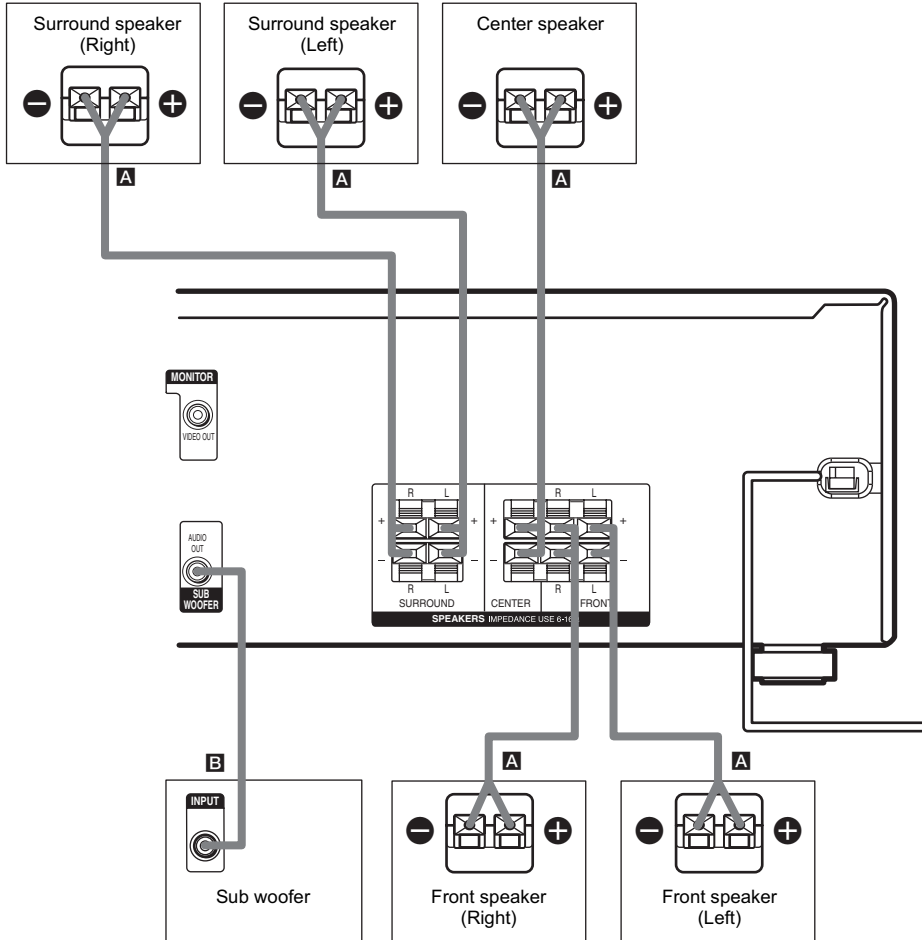

4: Connecting the AC power cord

Connect the AC power cord to a wall outlet.

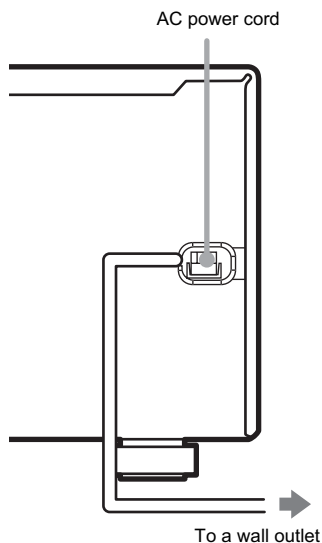

Performing initial setup operations

Before using the receiver for the first time, initialize the receiver by performing the following procedure.

This procedure can also be used to return settings you have made to their factory defaults.

Use the buttons on the receiver for the operation.

1 Press I/⏻ to turn off the receiver.

2 Hold down I/⏻ for 5 seconds.

“PUSH” and “ENTER” appears in the display alternately.

3 Press ENTER.

“CLEARING” appears in the display for a while, then “CLEARED” appears.

The following are reset to their factory settings.

- All settings in the SET UP, LEVEL, TONE and CUSTOMIZE menus.
- The sound field memorized for each input and preset station.
- All sound field parameters.
- All preset stations.
- All index names for inputs and preset stations.
- MASTER VOLUME -/+ is set to “VOL MIN”.

5: Setting up the speakers

You can use the SET UP menu to set the distance and location of the speakers connected to this receiver.

- 1 Press **I/⏻** to turn on the receiver.
- 2 Press **MAIN MENU** repeatedly to select “<SET UP>”.
- 3 Press **<** or **>** repeatedly to select the parameter you want to adjust.

For details, see “Speaker setup parameters” below.

Note

Some speaker setup items may appear dimmed in the display. This means that they have been adjusted automatically due to other speaker settings or may not be adjustable.

- 4 Press **+** or **-** repeatedly to select the setting you want.
The setting is entered automatically.
- 5 Repeat steps 3 and 4 until you have set all of the items that follow.

Speaker setup parameters

The initial setting is underlined>.

-   **DIST. XX ft.**
(Front speaker distance)

Initial setting: 10 ft.

Lets you set the distance from your listening position to the front speakers (**A**). You can adjust from 3 to 23 feet in 1 foot steps.

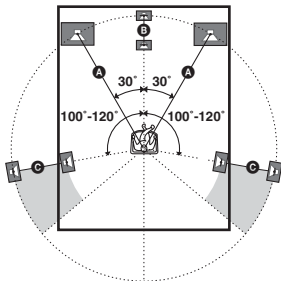

If both front speakers are not placed an equal distance from your listening position, set the distance to the closest speaker.



-  **DIST. XX ft.**
(Center speaker distance)

Initial setting: 10 ft.

Lets you set the distance from your listening position to the center speaker. Center speaker distance should be set from a distance equal to the front speaker distance (**A**) to a distance 5 feet closer to your listening position (**B**).

-   **DIST. XX ft.**
(Surround speaker distance)

Initial setting: 10 ft.

Lets you set the distance from your listening position to the surround speakers. Surround speaker distance should be set from a distance equal to the front speaker distance (**A**) to a distance 15 feet closer to your listening position (**C**).

If both surround speakers are not placed an equal distance from your listening position, set the distance to the closest speaker.

Tip

The receiver lets you to input the speaker position in terms of distance. However, it is not possible to set the center speaker further than the front speakers. Also, the center speaker cannot be set more than 5 feet closer than the front speakers.

Likewise, the surround speakers cannot be set further away from the listening position than the front speakers. And they can be no more than 15 feet closer. This is because incorrect speaker placement is not conducive to the enjoyment of surround sound.

Please note that, setting the speaker distance closer than the actual location of the speakers will cause a delay in the output of the sound from that speaker. In other words, the speaker will sound like it is further away.

For example, setting the center speaker distance 3–6 feet closer than the actual speaker position will create a fairly realistic sensation of being “inside” the screen.

If you cannot obtain a satisfactory surround effect because the surround speakers are too close, setting the surround speaker distance closer (shorter) than the actual distance will create a larger sound stage.

Adjusting these parameter while listening to the sound often results in much better surround sound. Give it a try!

continued

(Surround speaker placement)

Lets you specify the height of your surround speakers for proper implementation of the surround effects of the Cinema Studio EX modes (page 23).

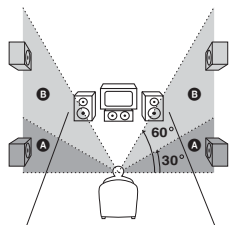

- **LOW**
Select if the height of your surround speakers corresponds to section **A**.
- **HIGH**
Select if the height of your surround speakers corresponds to section **B**.

6: Setting up the sub woofer

Listening to the sub woofer

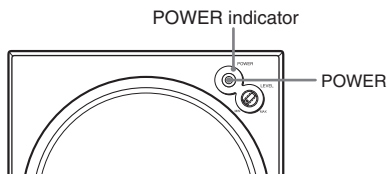

Before playing the program source, set the volume to minimum on the receiver.

- 1** Turn on the receiver.
- 2** Press input buttons (e.g., DVD) to select the program source (e.g., DVD player).
- 3** Press **POWER** on the sub woofer.
The POWER indicator on the sub woofer lights up.
- 4** Play the program source.

Adjusting the level

Slight adjustments to the system can enhance your sound enjoyment.

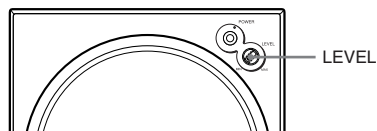

Turn LEVEL to adjust the volume.

Set the volume level to best suit your preference according to the program source.

Note

Do not set the volume of the sub woofer to maximum. Extraneous noise may be heard.

7: Adjusting the speaker levels and balance

— TEST TONE

Adjust the speaker levels and balance while listening to the test tone from your listening position. Use the remote for the operation.

Tip

The receiver employs a test tone with a frequency centered at 800 Hz.

1 Press **I/⏻** to turn on the receiver.

2 Press **TEST TONE**.

“T. TONE” appears in the display and the test tone is output from each speaker in sequence.

Front (left) → Center → Front (right) →
Surround (right) → Surround (left) →
Sub woofer

3 **Adjust the speaker levels and balance using the LEVEL menu so that the level of the test tone sounds the same from each speaker.**

For details on the LEVEL menu settings, see page 25.

Tips

- To adjust the level of all speakers at the same time, press MASTER VOL +/- on the remote or turn MASTER VOLUME +/- on the receiver.
- The adjusted value are shown in the display during adjustment.

4 **Press TEST TONE again after adjustment.**

The test tone turns off.

Notes

- Although these adjustments can also be made via the front panel using the LEVEL menu (when the test tone is output, the receiver switches to the LEVEL menu automatically), we recommend you follow the procedure described above and adjust the speaker levels from your listening position using the remote.
- The bass redirection circuitry is always active, so you may hear some sound output from the sub woofer when test tone is output from other speakers. However, this is not a malfunction.

Amplifier Operation

Selecting the component

1 Press input buttons to select the input.

To select the	Press
VCR	VIDEO 1 or VIDEO 2
Satellite tuner	VIDEO 2
DVD player	DVD
MD or tape deck	MD/TAPE
CD player	CD
Built-in tuner (FM/AM)	TUNER FM/AM

The selected input appears in the display.

2 Turn on the component and start playback.

Note

If you select the VCR or DVD player, set the TV's video input to match the component you selected.

3 Turn MASTER VOLUME +/- to adjust the volume.

Note

To avoid damaging your speakers, make sure that you turn down the volume before you turn off the receiver.

To mute the sound

Press MUTING on the remote.

The muting function will be canceled when you do the following.

- Press MUTING on the remote again.
- Turn the power off.
- Increase the volume.

To use the headphones

Connect the headphones to the PHONES jack.

When the headphones are connected, speaker output is automatically canceled and "SP" does not light up in the display.

Listening to FM/AM radio

You can listen to FM and AM broadcasts through the built-in tuner. Before operation, make sure you have connected the FM and AM antennas to the receiver (see page 11).

Tip

The tuning scale is:

FM: 100 kHz

AM: 10 kHz*

* The AM tuning scale can be changed (see page 38).

Automatic tuning

If you do not know the frequency of the station you want, you can let the receiver scan all available stations in your area.

1 Press TUNER FM/AM repeatedly to select the FM or AM band.

The last received station is tuned in.

2 Press TUNING + or TUNING -.

Press TUNING + to scan from low to high; press TUNING - to scan from high to low.

The receiver stops scanning whenever a station is received.

Tip

If "STEREO" flashes in the display and the FM stereo reception is poor, press FM MODE to change to monaural (MONO). You will not be able to enjoy the stereo effect, but the sound will be less distorted. To return to stereo mode, press FM MODE again.

Direct tuning

You can enter the frequency of the station you want directly. Use the remote for the operation.

- 1 Press **TUNER** repeatedly to select the **FM or AM band**.

The last received station is tuned in.

Tip

You can also use TUNER FM/AM on the receiver.

- 2 Press **D.TUNING**.
- 3 Press the numeric buttons to enter the frequency.

Example 1: FM 102.50 MHz

Press 1 → 0 → 2 → 5 → 0

Example 2: AM 1,350 kHz

(You do not have to enter the last “0” when the tuning scale is set to 10 kHz.)

Press 1 → 3 → 5 → 0

If you have tuned in an AM station, adjust the direction of the AM loop antenna for optimum reception.

If you cannot tune in a station and the entered numbers flash

Make sure you have entered the right frequency. If not, repeat steps 2 and 3. If the entered numbers still flash, the frequency is not used in your area.

Presetting radio stations

You can preset up to 30 FM or AM stations. Then you can easily tune in the stations you often listen to.

Presetting radio stations

- 1 Press **TUNER FM/AM** repeatedly to select the **FM or AM band**.

The last received station is tuned in.

- 2 Tune in the station that you want to preset using **Automatic Tuning (page 18)** or **Direct Tuning (page 19)**.

- 3 Press **MEMORY**.

“MEMORY” appears in the display for a few seconds. Do steps 4 to 5 before the display goes out.

- 4 Press **PRESET TUNING +** or **PRESET TUNING –** repeatedly to select a preset station number.

Each time you press the button, you can select the preset station number as follows:

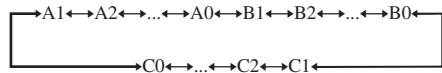

If “MEMORY” goes out before you select the preset station number, start again from step 3.

Tip

You can also use the remote to select a preset station number. Press **SHIFT** repeatedly to select a memory page (A, B or C) and then press the numeric buttons to select a preset number.

- 5 Press **MEMORY** again.

The station is stored to the selected preset number.

If “MEMORY” goes out before you press **MEMORY**, start again from step 3.

- 6 Repeat steps 2 to 5 to preset another station.

Tuning to preset stations

- 1 Press **TUNER FM/AM** repeatedly to select the FM or AM band.

The last received station is tuned in.

- 2 Press **PRESET TUNING +** or **PRESET TUNING -** repeatedly to select the preset station you want.

Each time you press the button, you can select the preset station as follows:

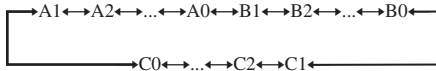

Using the remote

- 1 Press **TUNER** repeatedly to select the FM or AM band.
- 2 Press **PRESET/CH/D.SKIP +/-** repeatedly to select the preset station you want.

To select the preset station directly

Press the numeric buttons on the remote.

The preset station of the selected number in the current memory page is tuned in. Press **SHIFT** repeatedly on the remote to change the memory page.

Changing the display

Changing the information in the display

You can check the sound field etc. by changing the information in the display.

Press **DISPLAY** repeatedly.

Each time you press **DISPLAY**, the display will change cyclically as follows.

Index name of the input* → Selected input → Sound field currently applied

When the tuner is selected

Preset station name* → Frequency → Sound field currently applied

* Index name appears only when you have assigned one to the input or preset station (page 29). Index name does not appear when only blank spaces have been entered, or it is the same as the input name.

Adjusting the brightness of the display

Press **DIMMER** repeatedly.

The brightness of the display will change in 3 steps.

About the indications in the display

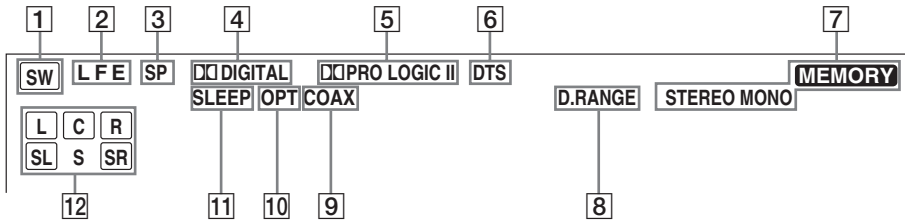

- 1 SW:** Lights up when the audio signal is output from the SUB WOOFER jack.
- 2 LFE:** Lights up when the disc being played back contains the LFE (Low Frequency Effect) channel and the LFE channel signal is actually being reproduced.
- 3 SP:** Lights up when you turn on the receiver. Turns off when you connect headphones to the PHONES jack.
- 4 DIGITAL:** Lights up when the receiver is decoding signals recorded in the Dolby Digital format.
- 5 PRO LOGIC II:** “ PRO LOGIC” lights up when the receiver applies Pro Logic processing to 2 channel signals in order to output the center and surround channel signals. “ PRO LOGIC II” lights up when the Pro Logic II Movie/Music decoder is activated.

Note
Dolby Pro Logic and Dolby Pro Logic II decoding do not function for DTS format signals.
- 6 DTS:** Lights up when DTS signals are input.

Note
When playing a DTS format disc, be sure that you have made digital connections and that INPUT MODE is not set to “ANALOG” (page 25).
- 7 Tuner indicators:** Lights up when using the receiver to tune in radio stations, etc. See pages 18–20 for tuner operations.
- 8 D.RANGE:** Lights up when dynamic range compression is activated (page 26).

- 9 COAX:** Lights up when the source signal is a digital signal being input through the COAXIAL terminal.
- 10 OPT:** Lights up when the source signal is a digital signal being input through the OPTICAL terminal.
- 11 SLEEP:** Lights up when sleep timer is activated.
- 12 Playback channel indicators:** The letters (L, C, R, etc.) indicate the channels being played back. The boxes around the letters vary to show how the receiver downmixes the source sound.

L (Front Left), R (Front Right), C (Center (monaural)), SL (Surround Left), SR (Surround Right), S (Surround (monaural) or the surround components obtained by Pro Logic processing))

Example:

Recording format (Front /Surround): 3/2
Sound Field: A.F.D. AUTO



Enjoying Surround Sound

Using only the front speakers and sub woofer

— 2CH STEREO

In this mode, the receiver outputs the sound from the front left/right speakers and sub woofer only.

When multi channel surround formats are input, the signals are downmixed to 2 channel with bass frequencies being output from the sub woofer.

When standard 2 channel stereo sources are input, the receiver's bass redirection circuitry will be activated. The front channel bass frequencies will be output from the sub woofer.

Press 2CH.

"2CH ST." appears in the display and the receiver switches to the 2CH STEREO mode.

Enjoying higher fidelity sound

— AUTO FORMAT DIRECT

The Auto Format Direct (A.F.D.) mode allows you to select the decoding mode you want for your audio sound.

A.F.D. mode (Display)	Decoding mode
A.F.D. AUTO (A.F.D. AUTO)	As encoded
PRO LOGIC (DOLBY PL)	Dolby Pro Logic
PRO LOGIC II MOVIE (PLII MOV)	Dolby Pro Logic II
PRO LOGIC II MUSIC (PLII MUS)	

Decoding the input audio signal automatically

In this mode, the receiver automatically detects the type of audio signal being input (Dolby Digital, DTS, standard 2 channel stereo, etc.) and performs the proper decoding if necessary. This mode presents the sound as it was recorded/encoded, without adding any surround effects. However, if there are no low frequency signals (Dolby Digital LFE, etc.) it will generate a low frequency signal for output to the sub woofer.

Press A.F.D. repeatedly to select "A.F.D. AUTO".

The receiver automatically detects the type of audio signal being input and performs the proper decoding if necessary.

Enjoying stereo sound in multi channel (2 channel decoding mode)

This mode lets you specify the type of decoding for 2 channel audio sources. This receiver can reproduce 2 channel sound in 5 channels through Dolby Pro Logic II or 4 channels through Dolby Pro Logic.

Press A.F.D. repeatedly to select the 2 channel decoding mode.

The selected type of decoding appears in the display.

■ DOLBY PL (PRO LOGIC)

Performs Dolby Pro Logic decoding. The source recorded in 2 channel is decoded into 4.1 channels.

■ PLII MOV (PRO LOGIC II MOVIE)

Performs Dolby Pro Logic II Movie mode decoding. This setting is ideal for movies encoded in Dolby Surround. In addition, this mode can reproduce sound in 5.1 channel when watching videos of overdubbed or old movies.

■ PLII MUS (PRO LOGIC II MUSIC)

Performs Dolby Pro Logic II Music mode decoding. This setting is ideal for normal stereo sources such as CDs.

Note

Dolby Pro Logic and Dolby Pro Logic II decoding do not function for DTS format signals.

Selecting a sound field

You can take advantage of surround sound simply by selecting one of the receiver's pre-programmed sound fields. They bring the exciting and powerful sound of movie theaters and concert halls into your home.

Selecting a sound field for movies

Press MOVIE repeatedly to select the sound field you want.

The selected sound field appears in the display.

Sound field	Display
CINEMA STUDIO EX A DCS	C.ST.EX A
CINEMA STUDIO EX B DCS	C.ST.EX B
CINEMA STUDIO EX C DCS	C.ST.EX C

About DCS (Digital Cinema Sound)

Sound fields with **DCS** marks use DCS technology.

DCS is the concept name of the surround technology for home theater developed by Sony. DCS uses the DSP (Digital Signal Processor) technology to reproduce the sound characteristics of an actual cinema cutting studio in Hollywood.

When played at home, DCS will create a powerful theater effect that mimics the artistic combination of sound and action as envisioned by the movie director.

■ C.ST.EX A (CINEMA STUDIO EX A) **DCS**

Reproduces the sound characteristics of the Sony Pictures Entertainment "Cary Grant Theater" cinema production studio. This is a standard mode, great for watching most any type of movies.

■ C.ST.EX B (CINEMA STUDIO EX B) **DCS**

Reproduces the sound characteristics of the Sony Pictures Entertainment "Kim Novak Theater" cinema production studio. This mode is ideal for watching science-fiction or action movies with lots of sound effects.

■ C.ST.EX C (CINEMA STUDIO EX C) **DCS**

Reproduces the sound characteristics of the Sony Pictures Entertainment scoring stage. This mode is ideal for watching musicals or films where orchestra music is featured in the soundtrack.

About CINEMA STUDIO EX modes

CINEMA STUDIO EX modes are suitable for watching motion picture DVDs (etc.), with multi channel surround effects. You can reproduce the sound characteristics of Sony Pictures Entertainment's dubbing studio in your home.

The CINEMA STUDIO EX modes consist of the following three elements.

- Virtual Multi Dimension
Creates 5 sets of virtual speakers from a single pair of actual surround speakers.
- Screen Depth Matching
Creates the sensation that the sound is coming from inside the screen like in theaters.
- Cinema Studio Reverberation
Reproduces the type of reverberation found in theaters.

The CINEMA STUDIO EX modes integrate these three elements simultaneously.

Notes

- The effects provided by the virtual speakers may cause increased noise in the playback signal.
- When listening with sound fields that employ the virtual speakers, you will not be able to hear any sound coming directly from the surround speakers.

Selecting a sound field for music

Press **MUSIC** repeatedly to select the sound field you want.

The selected sound field appears in the display.

Sound field	Display
HALL	HALL
JAZZ CLUB	JAZZ
LIVE CONCERT	CONCERT

■ HALL

Reproduces the acoustics of a classical concert hall.

■ JAZZ (JAZZ CLUB)

Reproduces the acoustics of a jazz club.



■ CONCERT (LIVE CONCERT)

Reproduces the acoustics of a 300-seat live house.

To turn off the surround effect

Press 2CH to select "2CH ST." or press A.F.D. repeatedly to select "A.F.D. AUTO".

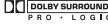
Tips

- The receiver lets you apply the last selected sound field to an input whenever it is selected (Sound Field Link). For example, if you select HALL for the CD input, then change to a different input and then return to CD, HALL will automatically be applied again.
- You can identify the encoding format of DVD software, etc. by looking at the logo on the package.
 -  : Dolby Digital discs
 -  : Dolby Surround encoded programs
 -  : DTS Digital Surround encoded programs

Note

Sound fields do not function for the signals with a sampling frequency of more than 48 kHz.

Switching the audio input mode for digital components

— INPUT MODE

You can switch the audio input mode for components which have digital audio input jacks.

- 1 Press input buttons to select the input.**
- 2 Press INPUT MODE repeatedly to select the audio input mode.**

The selected audio input mode appears in the display.

Audio input modes

- **AUTO IN**
Gives priority to digital signals when there are both digital and analog connections. If there are no digital signals, analog is selected.
- **COAX IN**
Specifies the digital audio signals input to the DIGITAL COAXIAL input jack.
- **OPT IN**
Specifies the digital audio signals input to the DIGITAL OPTICAL input jacks.
- **ANALOG**
Specifies the analog audio signals input to the AUDIO IN (L/R) jacks.

Note

When signals with a sampling frequency of more than 48 kHz is input, the tone and sound field cannot be used.

Customizing sound fields

By adjusting the LEVEL menu, you can customize the sound fields to suit your particular listening situation.

Note on the displayed items

The setup items you can adjust in each menu vary depending on the sound field. Certain setup parameters may be dimmed in the display. This means that the selected parameter is either unavailable or fixed and unchangeable.

Adjusting the LEVEL menu

You can adjust the balance and level of each speaker. These settings are applied to all sound fields except for the effect level parameter. The effect level parameter settings are stored individually for each sound field.

- 1 Start playing a source encoded with multi channel surround effects (DVD, etc.).**
- 2 Press MAIN MENU repeatedly to select “<LEVEL>”.**
- 3 Press < or > repeatedly to select the parameter you want to adjust.**
For details, see “LEVEL menu parameters” below.
- 4 While monitoring the sound, press + or – repeatedly to select the setting you want.**
The setting is entered automatically.
- 5 Repeat steps 3 and 4 to adjust the other parameters.**

LEVEL menu parameters

The initial setting is underlined>.

-   **BAL. L/R XX**
(Front speaker balance)

Initial setting: BALANCE (0)

Lets you adjust the balance between front left and right speakers. You can adjust in the range of BAL. L (+1 to +8), BALANCE (0), BAL. R (+1 to +8) in 17 steps.

■ **CTR XXX dB**
(Center speaker level)

■ **SUR.L. XXX dB**
(Surround speaker (left) level)

■ **SUR.R. XXX dB**
(Surround speaker (right) level)

■ **S.W. XXX dB**
(Sub woofer level)

Initial setting: 0 dB

You can adjust from -10 dB to +10 dB in 1 dB steps.

■  **COMP. XXX**
(Dynamic range compressor)

Lets you compress the dynamic range of the sound track. This may be useful when you want to watch movies at low volumes late at night.

• **OFF**

The dynamic range is not compressed.

• **STD**

The dynamic range is compressed as intended by the recording engineer.

• **MAX**

The dynamic range is compressed dramatically.

Tip

Dynamic range compressor lets you compress the dynamic range of the soundtrack based on the dynamic range information included in the Dolby Digital signal. We recommend using the "MAX" setting. This greatly compresses the dynamic range and lets you view movies late at night at low volumes. Unlike analog limiters, the levels are predetermined and provide a very natural compression.

Note

Dynamic range compression is possible with Dolby Digital sources only.

■ **EFCT. XXX (Effect level)**

Initial setting: STD

Lets you adjust the "presence" of the surround effect.

Resetting sound fields to the initial settings

Use the buttons on the receiver for the operation.

1 Press I/⏻ to turn off the power.

2 While holding down 2CH, press I/⏻.

"SF. CLR." appears in the display and all sound fields are reset to the initial setting.

Adjusting the tone

You can adjust the tonal quality (bass, treble level) of the front speaker using the TONE menu.

- 1 Start playing a source encoded with multi channel surround effects (DVD, etc.).**
- 2 Press MAIN MENU repeatedly to select “<TONE>”.**
- 3 Press < or > repeatedly to select the parameter you want to adjust.**
For details, see “TONE menu parameters” below.
- 4 While monitoring the sound, press + or – repeatedly to select the setting you want.**
The setting is entered automatically.
- 5 Repeat steps 3 and 4 to adjust the other items.**

Note

You cannot adjust the tone when the receiver is decoding signals with a sampling frequency of more than 48 kHz.

TONE menu parameters

- **BASS XX dB**
(Front speaker bass level)
- **TREB. XX dB**
(Front speaker treble level)

Initial setting: 0 dB

You can adjust from –6 dB to +6 dB in 1 dB steps.

Advanced settings

Using the CUSTOMIZE menu to adjust the receiver

You can adjust various receiver settings using the CUSTOMIZE menu.

- 1 Press MAIN MENU repeatedly to select “<CUSTOM>”.**
- 2 Press < or > repeatedly to select the parameter you want to adjust.**
For details, see “CUSTOMIZE menu parameters” below.
- 3 Press + or – repeatedly to select the setting you want.**
The setting is entered automatically.
- 4 Repeat steps 2 and 3 to adjust the other items.**

CUSTOMIZE menu parameters

The initial setting is underlined>.

■ **DEC. XXXX** (Digital audio input decoding priority)

Lets you specify the input mode for the digital signal input to the DIGITAL IN jacks.

The initial setting is “DEC. AUTO” for VIDEO 2 and “DEC. PCM” for DVD.

- **AUTO**
Automatically switches the input mode between DTS, Dolby Digital, or PCM.
- **PCM**
PCM signals are given priority (to prevent the interruption when playback starts). Even when other signals are input, the sound is output. However, this receiver cannot decode DTS-CD when set to “DEC. PCM”.

Note

When set to “DEC. AUTO” and the sound from the digital audio jacks (for CD, etc.) is interrupted when playback starts, set to “DEC. PCM”.

■ DUAL XXX

(Digital broadcast language selection)

Lets you select the language you want to listen to during digital broadcast. This feature only functions for Dolby Digital sources.

- M/S (Main/Sub)

Sound of the main language will be output through the front left speaker and sound of the sub language will be output through the front right speaker simultaneously.

- M (Main)

Sound of the main language will be output.

- S (Sub)

Sound of the sub language will be output.

- M+S (Main + Sub)

Mixed sound of both the main and sub languages will be output.

■ NAME IN

(Naming preset stations and inputs)

Lets you set the name of preset stations and inputs selected with input buttons. For details, see “Naming preset stations and inputs” on page 29.

Naming preset stations and inputs

You can enter a name of up to 8 characters for preset stations and inputs selected with input buttons, and display it in the receiver's display.

1 To index a preset station

Press **TUNER FM/AM** repeatedly to select the **FM** or **AM** band, then tune in the preset station you want to create an index name for (page 20).

To index an input

Press the input button to select the input you want to create an index name for.

2 Press **MAIN MENU** repeatedly to select “<CUSTOM>”.

3 Press **<** or **>** repeatedly to select “NAME IN”.

4 Press **ENTER**.

The cursor flashes and you can select a character.

5 Use **<** or **>** and **+** or **-** to create an index name.

Press **+** or **-** repeatedly to select a character, then press **>** to move the cursor to the next position.

Tips

- You can select the character type as follows by pressing **+** or **-** repeatedly.
Alphabet (upper case) → Numbers → Symbols
- To enter a blank space, press **+** or **-** repeatedly until a blank space appears in the display.
- If you made a mistake, press **<** or **>** repeatedly until the character you want to change flashes, then press **+** or **-** repeatedly to select the correct character.

6 Press **ENTER** to store the index name.

Using the Sleep Timer

You can set the receiver to turn off automatically at a specified time. Use the remote for the operation.

1 Press **ALT** to light up the button.

2 Press **SLEEP** while the power is on.

Each time you press **SLEEP**, the display changes cyclically as follows:

2-00-00 → 1-30-00 → 1-00-00 →
0-30-00 → OFF

While using Sleep Timer, “SLEEP” lights up in the display.

Tip

To check the remaining time before the receiver turns off, press **ALT** to light up the button (page 32), then press **SLEEP**. The remaining time appears in the display. If you press **SLEEP** again, the sleep timer will be canceled.

Recording

Before you begin, make sure you have connected all components properly.

Recording on an audio tape or MiniDisc

You can record on a cassette tape or MiniDisc using the receiver. See the operating instructions of your cassette deck or MD deck if you need help.

- 1 Select the component to be recorded.**
- 2 Prepare the component for playing.**
For example, insert a CD into the CD player.
- 3 Insert a blank tape or MD into the recording deck and adjust the recording level, if necessary.**
- 4 Start recording on the recording deck, then start playback on the playback component.**

Notes

- Sound adjustments do not affect the signal output from the MD/TAPE OUT jacks.
- The analog audio signals of the current input is output from the MD/TAPE OUT jacks.

Recording on a video tape

You can record from a VCR, a TV or a DVD using the receiver. You can also add audio from a variety of audio sources when editing a video tape. See the operating instructions of your VCR or DVD player if you need help.

- 1 Select the program source to be recorded.**
- 2 Prepare the component for playing.**
For example, insert a video tape you want to record into VCR.
- 3 Insert a blank video tape into the VCR (VIDEO 1) for recording.**
- 4 Start recording on the recording VCR, then start playing the video tape or DVD you want to record.**

Tip

You can record the sound from any audio source onto a video tape while copying from a video tape or DVD. Locate the point where you want to start recording from another audio source, select the program source, then start playback. The audio from that source will be recorded onto the audio track of the video tape instead of the audio from the original medium. To resume audio recording from the original medium, select the video source again.

Notes

- You cannot record a digital audio signal using a component connected to the analog VIDEO 1 OUT jacks.
- Make sure to make both digital and analog connections to the VIDEO 2 and DVD inputs. Analog recording is not possible if you make only digital connections.
- The analog audio signals of the current input are output from the VIDEO 1 OUT jacks.

Operations Using the Remote RM-U755

You can use the remote RM-U755 to operate the components in your system.

Before you use your remote

Inserting batteries into the remote

Insert R6 (size-AA) batteries with the + and – properly oriented in the battery compartment. When using the remote, point it at the remote sensor  on the receiver.

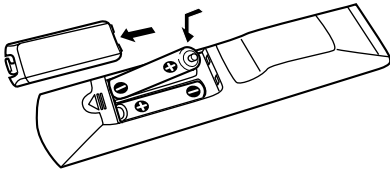

Tip

Under normal conditions, the batteries should last for about 6 months. When the remote no longer operates the receiver, replace all batteries with new ones.

Notes

- Do not leave the remote in an extremely hot or humid place.
- Do not use a new battery with an old one.
- Do not expose the remote sensor to direct sunlight or lighting apparatuses. Doing so may cause a malfunction.
- If you don't use the remote for an extended period of time, remove the batteries to avoid possible damage from battery leakage and corrosion.

Remote button description

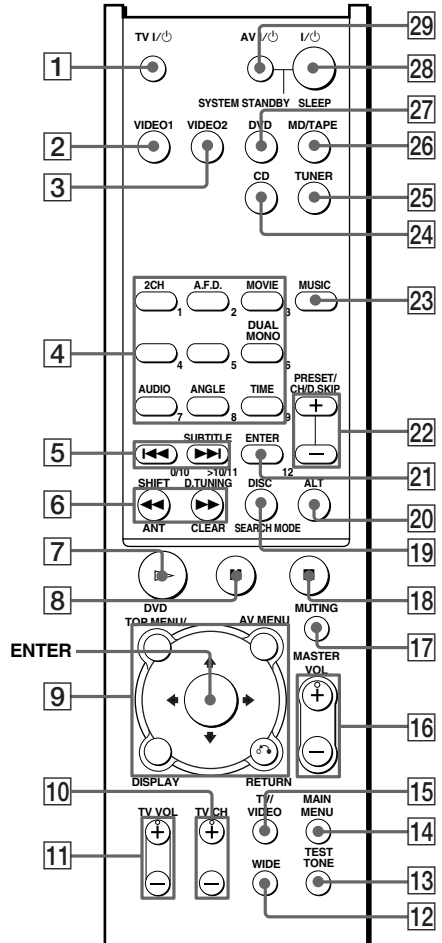

Operations Using the Remote RM-U755



















The tables below show the settings of each button.













Remote Button	Operations	Function
A.F.D. 4	Receiver	Selects the decoding mode for audio sound.

continued

Remote Button	Operations	Function
ALT 20	Remote	When ALT button lights up, it changes the remote key function to activate those buttons with orange printing.
ANGLE 4	DVD player	Selects viewing angle or changes the angles.
ANT 6	VCR	Selects output signal from the antenna terminal: TV signal or VCR program.
AUDIO 4	VCR/ DVD player	Changes the sound to Multiplex, Bilingual or Multi channel TV Sound.
AV MENU 9	VCR/ DVD player	Displays menu.
AV I/⏮ 29	VCR/ CD player/ DVD player/ MD deck	Turns the audio and video components on or off.
CD 24	Receiver	To listen to compact disc.
CLEAR 6	DVD player	Press if you make a mistake when you press the numeric button or press to return to continuous play etc.
DISC 19	CD player	Selects a disc directly (multi-disc changer only).
DISPLAY 9	VCR/ DVD player	Selects information displayed on the TV screen.
D.TUNING 6	Receiver	Enters direct tuning mode.
DUAL MONO 4	Receiver	Selects the language you want during digital broadcast.
DVD 27	Receiver	To watch DVD.
DVD TOP MENU 9	DVD player	Displays DVD title.

Remote Button	Operations	Function
ENTER/12 21	VCR/ MD deck	After selecting a channel, disc or track using the numeric buttons, press to enter the value.
ENTER 9	VCR/ DVD player	Enters the selection.
MAIN MENU 14	Receiver	Selects the menu of the receiver.
MASTER VOL +/- 16	Receiver	Adjusts the master volume of the receiver.
MD/TAPE 26	Receiver	To listen to Minidisc or audio tape.
MOVIE 4	Receiver	Selects the pre-programmed sound fields for movie.
MUSIC 23	Receiver	Selects the pre-programmed sound fields for music.
MUTING 17	Receiver	Mutes the sound from the receiver.
PRESET/	Receiver	Selects preset stations.
CH/D.SKIP +/- 22	VCR CD player/ DVD player/ MD deck	Selects preset channels. Skips discs (multi-disc changer only).
RETURN 9	DVD player	Returns to the previous menu.
SEARCH MODE 19	DVD player	Selects searching mode. Press to select the unit for search (track, index, etc.)
SHIFT 6	Receiver	Selects a memory page for presetting radio stations or tuning to preset stations.
SLEEP 28	Receiver	Activates the sleep function and the duration which the receiver turns off automatically.

Remote Button	Operations	Function
SUBTITLE  5	DVD player	Changes the subtitles.
SYSTEM STANDBY (Press AV  29 and  28 at the same time)	Receiver/TV/ VCR/ CD player/ DVD player/ MD deck	Turns off the receiver and other Sony audio/video components.
TEST TONE  13	Receiver	Outputs test tone.
TIME  4	CD player/ DVD player/ MD deck	Shows the time or displays the playing time of disc, etc.
TUNER  25	Receiver	To listen to radio programs.
TV CH +/-  10	TV	Selects preset TV channels.
TV/VIDEO  15	TV	Selects input signal: TV input or video input.
TV VOL +/-  11	TV	Adjusts the volume of the TV.
TV  1	TV	Turns the TV on or off.
VIDEO1  2	Receiver	To watch VCR. (VTR mode 3)
VIDEO2  3	Receiver	To watch VCR. (VTR mode 1)
WIDE  12	TV	Selects the wide picture mode.
 28	Receiver	Turns the receiver on or off.
2CH  4	Receiver	Selects 2CH STEREO mode.
 9	Receiver	Selects a menu item.
 9	Receiver	Adjusts or changes the setting.
 9	VCR/ DVD player	Selects a menu item.

Remote Button	Operations	Function
1-9  4 and 0/10  5	Receiver	Use with SHIFT to preset radio station or tuning to preset stations and with D.TUNING for direct tuning.
	CD player/ MD deck	Selects track numbers. 0/10 selects track 10.
	VCR	Selects channel numbers.
>10/11  5	CD player/ MD deck	Selects track numbers over 10.
   5	VCR/ CD player/ DVD player/ MD deck	Skips tracks.
   6	CD player/ DVD player/ MD deck	Searches tracks in the DVD player/ forward or backward direction.
	VCR/ Tape deck	Fastforwards or rewinds.
 7	VCR/ CD player/ DVD player/ MD deck/ Tape deck	Starts playback.
 8	VCR/ CD player/ DVD player/ MD deck/ Tape deck	Pauses playback or record. (Also starts recording with components in recording standby.)
 18	VCR/ CD player/ DVD player/ MD deck/ Tape deck	Stops playback.
 9	DVD player	Returns to the previous menu or exits the menu.

Notes

- Some functions explained in this section may not work depending on the model.
- The above explanation is intended to serve as an example only. Therefore, depending on the component the above operation may not be possible or may operate differently than described.
- To activate the buttons with orange printing, press ALT first before pressing the buttons.
- When you press input buttons (VIDEO1, 2 or DVD), the input mode of the TV might not switch to the corresponding input mode that you want. In this case, press the TV/VIDEO button to switch the input mode of the TV.

Changing the factory setting of an input button

If the factory settings of the input buttons do not match your system components, you can change them. For example, if you have a tape deck and you do not have an MD deck, you can assign the MD/TAPE button to your tape deck.

1 Hold down the input button whose input you want to change (for example, MD/TAPE).

2 Press the corresponding button of the component you want to assign to the input button (for example, 8 – Tape deck B).

The following buttons are assigned to select the input:

To operate	Press
CD player	1
VCR (command mode VTR 1*)	2
VCR (command mode VTR 3*)	3
DVD	4
Tuner	5
MD deck	6
Tape deck A	7
Tape deck B	8

*Sony VCRs are operated with a VTR 1 or 3 setting. These correspond to VTR mode 1 and VTR mode 3 respectively.

Now you can use the MD/TAPE button to control the tape deck B.

To reset a button to its factory setting

Repeat the above procedure.

To reset all the input buttons to their factory setting

Press I/⏻, AV I/⏻ and MASTER VOL – at the same time.

Additional Information

Precautions

On safety

Should any solid object or liquid fall into the cabinet, unplug the receiver and have it checked by qualified personnel before operating it any further.

On power sources

- Before operating the receiver, check that the operating voltage is identical with your local power supply. The operating voltage is indicated on the nameplate at the rear of the receiver.
- The receiver is not disconnected from the AC power source (mains) as long as it is connected to the wall outlet, even if the receiver itself has been turned off.
- If you are not going to use the receiver for a long time, be sure to disconnect the receiver from the wall outlet. To disconnect the AC power cord, grasp the plug itself; never pull the cord.
- One blade of the plug is wider than the other for the purpose of safety and will fit into the wall outlet only one way. If you are unable to insert the plug fully into the outlet, contact your dealer.
- AC power cord must be changed only at the qualified service shop.

On heat buildup

Although the receiver heats up during operation, this is not a malfunction. If you continuously use this receiver at a large volume, the cabinet temperature of the top, side and bottom rises considerably. To avoid burning yourself, do not touch the cabinet.

On placement

- Place the receiver in a location with adequate ventilation to prevent heat buildup and prolong the life of the receiver.
- Do not place the receiver near heat sources, or in a place subject to direct sunlight, excessive dust or mechanical shock.
- Do not place anything on top of the cabinet that might block the ventilation holes and cause malfunctions.
- Use caution when placing the receiver or speakers on surfaces that have been specially treated (with wax, oil, polish, etc.) as staining or discoloration of the surface may result.

On operation

Before connecting other components, be sure to turn off and unplug the receiver.

If you encounter color irregularity on a nearby TV screen

The front and center speakers and the sub woofer are magnetically shielded to allow it to be installed near a TV set. However, color irregularities may still be observed on certain types of TV sets. As the surround speakers are not magnetically shielded, we recommend that you place the surround speakers slightly further away from TV set (page 12).

If color irregularity is observed...

Turn off the TV set once, then turn it on again after 15 to 30 minutes.

If color irregularity is observed again...

Place the speaker further away from the TV set.

If howling occurs

Reposition the speakers or turn down the volume on the receiver.

On cleaning

Clean the cabinet, panel and controls with a soft cloth slightly moistened with a mild detergent solution. Do not use any type of abrasive pad, scouring powder or solvent such as alcohol or benzine.

If you have any question or problem concerning your receiver, please consult your nearest Sony dealer.

Troubleshooting

If you experience any of the following difficulties while using the receiver, use this troubleshooting guide to help you remedy the problem.

There is no sound or only a very low-level sound no matter which component is selected.

- Check that the speakers and components are connected securely and correctly.
- Check that both the receiver and all components are turned on.
- Check that you have selected the correct component on the receiver.
- Check that MASTER VOLUME $-/+$ is not set at “VOL MIN”.
- Check that the headphones are not connected.
- Press MUTING on the remote to cancel the muting function.

There is no sound from a specific component.

- Check that the component is connected correctly to the audio input jacks for that component.
- Check that the cord(s) used for the connection is (are) fully inserted into the jacks on both the receiver and the component.
- Check that you have selected the correct component on the receiver.

There is no sound from one of the front speakers.

- Connect a pair of headphones to the PHONES jack to verify that sound is output from the headphones. If only one channel is output from the headphones, the component may not be connected to the receiver correctly. Check that all the cords are fully inserted into the jacks on both the receiver and the component. If both channels are output from the headphones, the front speaker may not be connected to the receiver correctly. Check the connection of the front speaker which is not outputting any sound.

There is no sound from analog 2 channel sources.

- Check that the INPUT MODE is not set to “COAX IN” or “OPT IN” (page 25).

There is no sound from digital sources (from COAXIAL or OPTICAL input jack).

- Check that the INPUT MODE is not set to “ANALOG” (page 25). Check that the INPUT MODE is not set to “COAX IN” for the sources from OPTICAL input jack, or set to “OPT IN” for the sources from COAXIAL input jack.

The left and right sounds are unbalanced or reversed.

- Check that the speakers and components are connected correctly and securely.
- Adjust balance parameters in the LEVEL menu.

There is severe hum or noise.

- Check that the speakers and components are connected securely.
- Check that the connecting cords are away from a transformer or motor, and at least 10 feet away from a TV set or fluorescent light.
- Move your TV away from the audio components.
- The plugs and jacks are dirty. Wipe them with a cloth slightly moistened with alcohol.

There is no sound or only a very low-level sound is heard from the center or/and surround speakers.

- Make sure the sound field function is on (press A.F.D., MOVIE or MUSIC).
- Select a CINEMA STUDIO EX mode (page 23).
- Adjust the speaker level (page 17).

There is no sound from the sub woofer.

- Check that the sub woofer is connected correctly and securely.

The surround effect cannot be obtained.

- Make sure the sound field function is on (press A.F.D., MOVIE or MUSIC).
- Sound fields do not function for the signals with a sampling frequency of more than 48 kHz.

Dolby Digital or DTS multi channel sound is not reproduced.

- Check that the playing DVD, etc. is recorded in Dolby Digital or DTS format.
- When connecting the DVD player, etc. to the digital input jacks of this receiver, check the audio setting (settings for the audio output) of the connected component.

Recording cannot be done.

- Check that the components are connected correctly.
- Select the source component with input buttons.

The FM reception is poor.

- Use a 75-ohm coaxial cable (not supplied) to connect the receiver to an outdoor FM antenna as shown below. If you connect the receiver to an outdoor antenna, ground it against lightning. To prevent a gas explosion, do not connect the ground wire to a gas pipe.

Outdoor FM antenna

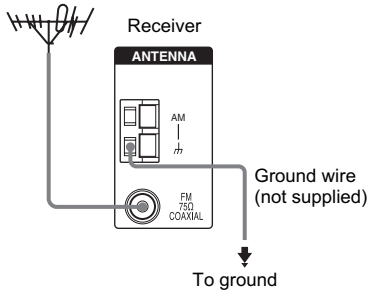

Radio stations cannot be tuned in.



- Check that the antennas are connected securely. Adjust the antennas and connect an external antenna if necessary.
- The signal strength of the stations is too weak (when tuning in with automatic tuning). Use direct tuning.
- Make sure you set the tuning interval correctly (when tuning in AM stations with direct tuning).
- No stations have been preset or the preset stations have been cleared (when tuning by scanning preset stations). Preset the stations (page 19).
- Press DISPLAY repeatedly so that the frequency appears in the display.

There is no picture or an unclear picture appears on the TV screen or monitor.

- Select the appropriate input on the receiver.
- Set your TV to the appropriate input mode.
- Move your TV away from the audio components.

Remote control

The remote does not function.

- Point the remote at the remote sensor  on the receiver.
- Remove any obstacles in the path between the remote and the receiver.
- Replace all the batteries in the remote with new ones, if they are weak.
- Make sure you select the correct input on the remote.
- To activate the buttons with orange printing, press ALT first before pressing the buttons.
- Before you use the  button for receiver operation, press MAIN MENU. To operate other components, press DVD TOP MENU or AV MENU after pressing the input button.

Error message

If there is a malfunction, the display shows a message.

PROTECT

Irregular current is output from the speakers. The receiver will automatically turn off after a few seconds. Check the speaker connection and turn on the power again. If this problem persists, consult your nearest Sony dealer.

If you are unable to remedy the problem using the troubleshooting guide

Clearing the receiver's memory may remedy the problem (page 14). However, note that all memorized settings will be reset to their factory settings and you will have to readjust all settings on the receiver.

If the problem persist

Consult your nearest Sony dealer.

Reference sections for clearing the receiver's memory

To clear	See
All memorized settings	page 14
Customized sound fields	page 26

Specifications

AUDIO POWER SPECIFICATIONS

POWER OUTPUT AND TOTAL HARMONIC DISTORTION: (Models of area code U only)

With 6 ohm loads, both channels driven, from 120 – 20,000 Hz; rated 60 watts per channel minimum RMS power, with no more than 0.7% total harmonic distortion from 250 milliwatts to rated output.

Amplifier section

Power Output¹⁾
(6 ohms 1 kHz, THD 10%)

FRONT²⁾: 80 W/ch
CENTER²⁾: 80 W
SURR²⁾: 80 W/ch

1) Measured under the following conditions:
120 V AC, 60 Hz

2) Depending on the sound field settings and the source, there may be no sound output.

Inputs (Analog)

CD, MD/TAPE, VIDEO 1, 2, DVD	Sensitivity: 800 mV Impedance: 50 kilohms
---------------------------------	--

Inputs (Digital)

DVD (Coaxial)	Sensitivity: – Impedance: 75 ohms
---------------	--------------------------------------

VIDEO 2 (Optical)	Sensitivity: – Impedance: –
-------------------	--------------------------------

Outputs (Analog)

MD/TAPE (OUT), VIDEO 1 (AUDIO OUT)	Voltage: 800 mV Impedance: 10 kilohms
SUB WOOFER	Voltage: 2 V Impedance: 1 kilohms

Reproduction frequency range:
28 – 20,000 Hz

Tone

Gain levels ±6 dB, 1 dB step

FM tuner section

Tuning range	87.5 - 108.0 MHz
Antenna	FM wire antenna
Antenna terminals	75 ohms, unbalanced
Intermediate Frequency	10.7 MHz

AM tuner section

Tuning range
With 10-kHz tuning scale: 530 - 1,710 kHz³⁾
With 9-kHz tuning scale: 531 - 1,710 kHz³⁾
Antenna Loop antenna
Intermediate Frequency 450 kHz

3) You can change the AM tuning scale to 9 kHz or 10 kHz. After tuning in any AM station, turn off the receiver. While holding down PRESET TUNING + or TUNING +, press I/C. All preset stations will be erased when you change the tuning scale. To reset the scale to 10 kHz (or 9 kHz), repeat the procedure.

Video section

Inputs/Outputs
Video: 1 Vp-p, 75 ohms

General

Power requirements	120 V AC, 60 Hz
Power consumption	160 W
Power consumption (during standby mode)	0.3 W

Dimensions (w/h/d) (Approx.)
430 × 145 × 301.5 mm
(17 × 5 6/8 × 11 7/8 inches)
including projecting parts
and controls

Mass (Approx.) 6.5 kg (14 lb 6 oz)

Speaker section

Front speakers (SS-MSP760L/ SS-MSP760R)

Center speaker (SS-CNP760)

Surround speakers (SS-MSP760SL/ SS-MSP760SR)

Front/center speakers	Full range, magnetically shielded
-----------------------	-----------------------------------

Surround speakers	Full range
Speaker units	80 mm cone type
Enclosure type	Bass reflex
Rated Impedance	6 ohms

Dimension (w/h/d) (Approx.)
Front/surround speakers 102 × 150 × 126 mm
(4 × 6 × 5 inches)

Center speaker 225 × 102 × 126 mm
(8 7/8 × 4 × 5 inches)

Mass (Approx.)	
Front speakers	0.8 kg (1 lb 13 oz)
Center speaker	1.0 kg (2 lb 4 oz)
Surround speakers	0.7 kg (1 lb 9 oz)

Sub woofer (SA-WMSP76)

AUDIO POWER SPECIFICATIONS

POWER OUTPUT AND TOTAL HARMONIC DISTORTION: (Models of area code U only)

With 6 ohm loads, from 28 – 200 Hz; rated 75 watts, minimum RMS power, with no more than 0.8% total harmonic distortion from 250 milliwatts to rated output.

Speaker system	Active subwoofer, magnetically shielded
Speaker unit	200 mm cone type
Enclosure type	Acoustically loaded bass reflex
RMS output:	100 W (6 ohms, 100 Hz, THD 10%)
Input	LINE IN (input pin jacks)
Power requirements	120 V AC, 60 Hz
Power consumption	75 W
Dimensions (w/h/d) (Approx.)	270 × 325 × 398 mm (10 3/4 × 12 7/8 × 15 3/4 inches) including front panel
Mass (Approx.)	9.0 kg (19 lb 14 oz)

Supplied accessories

- FM wire antenna (1)
- AM loop antenna (1)
- Speaker connecting cord, long (2)
- Speaker connecting cord, short (3)
- Monaural connecting cord (1)
- Coaxial digital cord (1)
- Foot pads (speakers) (20)
- Foot pads (subwoofer) (4)
- Remote commander (1)
- R6 (size-AA) batteries (2)
- Speakers
 - Front speakers (2)
 - Center speaker (1)
 - Surround speakers (2)
 - Sub woofer (1)

Design and specifications are subject to change without notice.

List of button locations and reference pages

How to use pages 40 and 41

Use this page to find the location of buttons that are mentioned in the text.

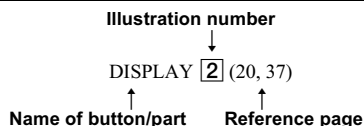

Main unit

ALPHABETICAL ORDER

A - L

A.F.D. (button/indicator) **7** (22, 23, 24, 36)
CD **23** (18)
DIMMER **3** (20)
DISPLAY **2** (20, 37)
Display **5** (20)
DVD **25** (18)
ENTER **11** (14, 29)
FM MODE **20** (18)
Input buttons **16** (18, 25, 28, 29, 37)
INPUT MODE **12** (21, 25)
IR (receptor) **4** (31, 37)

M - Z

MAIN MENU **15** (15, 25, 27, 29)
MASTER VOLUME +/- **10** (17, 18, 36)
MD/TAPE **24** (18)
MEMORY **19** (19)
MOVIE (button/indicator) **8** (23, 36)
MUSIC (button/indicator) **9** (24, 36)
PHONES (jack) **21** (18, 21, 36)
PRESET TUNING +/- **17** (19, 38)
TUNER FM/AM **22** (18, 19, 29)
TUNING +/- **18** (18, 38)
VIDEO 1 **27** (18)
VIDEO 2 **26** (18)

NUMBERS AND SYMBOLS

2CH (button/indicator) **6** (22, 24, 26)
+/- **13** (15, 25, 27, 29)
</> **14** (15, 25, 27, 29)
I/⏻ (power) **1** (14, 15, 38)

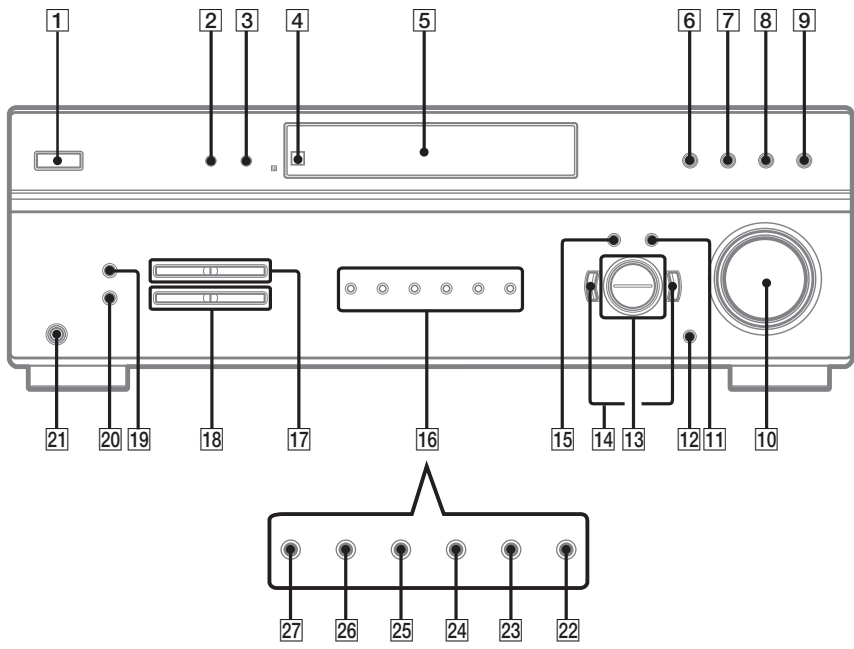

Additional Information

Index

A

Adjusting

- CUSTOMIZE parameters 27
- LEVEL parameter 25
- SET UP parameters 15
- speaker levels and balance 17
- TONE parameter 27

Automatic tuning 18

C

Changing

- display 20

Clearing receiver's memory 14

CUSTOMIZE menu 27

D

Digital Cinema Sound 23

Direct tuning 19

Dual Mono 28

Dubbing. *See* Recording

E

Editing. *See* Recording

I

Indexing. *See* Naming

L

Labeling. *See* Naming

LEVEL menu 25

N

Naming 29

P

Preset stations

- how to 19
- how to tune 20

R

Recording

- on a video tape 30
- on an audio tape or MD 30

S

Selecting

- component 18
- sound field 23–24

SET UP menu 15

Sleep Timer 29

Sound field

- customizing 25
- pre-programmed 23–24
- resetting 26
- selecting 23–24

Speakers

- adjusting speaker levels and balance 17
- connection 12
- placement 12

Supplied accessories 39

T

Test tone 17

TONE menu 27

Tuning

- automatically 18
- directly 19
- preset stations 19

