

DVBT-C30

User Manual

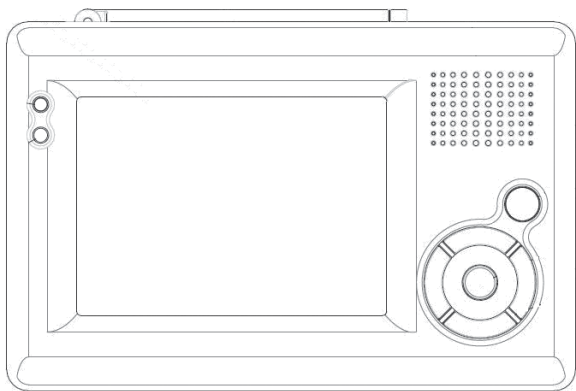

Please read carefully before use

DVBT-C30 User Manual

IMPORTANT SAFETY INSTRUCTIONS AND PRECAUTIONS

- Read the instructions carefully before using this product.
- Observe all warnings and cautions when using this product.
- Retain all manuals and documentation for future referral.
- Only use this product in a manner described in this manual.
- Do not use this product if you are in control of a motor vehicle.
- If used in a motor vehicle it should be used away from the driver to avoid distraction.
- This device is not waterproof. Do not use this device in extremely hot, cold, humid, dusty or sandy environments.
- Do not use this device in electrical storms or other conditions if the likelihood of lightning is possible.
- Do not attempt to clean this product using liquid cleaners or aerosol cleaners. Use only a damp soft cloth to clean the surface of this device.
- Extreme care should be taken when using this product near any body of water such as swimming pools, kitchen sinks, baths and alike.
- Only place the device on a stable surface and ensure that cables attached to the device can not cause the device to fall.
- Only use the recommended accessories for this device. Use of incorrect accessories may cause damage and void the warranty.

- Use only the recommended batteries in this device. The use of incorrect batteries may cause damage to the device or injury to the user.
- Using this device near other electronic devices may cause interference. Please use care using this product near other devices.
- Remove batteries from device if it is not to be used for long periods. Damage caused by leaking or faulty batteries is not covered by warranty.
- Care should be taken when using the external antenna. Please remove the fitting carefully from the device. Do not pull at the cord to remove it.
- Ensure that the ventilation holes are not blocked when using this device. Heat build up may cause this device to fail.
- There are no serviceable parts in this device. Attempts to open this device by unauthorised personnel may cause further damage and void the warranty.
- Picture quality will be dependant on signal quality and strength. This device may not be able to pick up all stations in all areas. For best results, use in a strong signal area and ensure that the antenna has a clear unobstructed view of the sky.

DVBT-C30 User Manual

TABLE OF CONTENTS

Important instruction and precaution	2
Table of contents	4
Accessory list and connection guide	5
Preparing the battery pack for use	6
Knowing your DVT	7
Basic operations	8
Using the Main Menu	9
Main Menu in detail	10
FM Radio	12
System setting	14
Quick setup	17
Connecting to a TV	18
Trouble Shooting	19
Specifications	20

ACCESSORY LIST

1. AC/DC Power adaptor
2. AV cord
3. Earphone
4. External Antenna
5. Battery Pack (NOT SHOWN)
6. MCX-to-ICE cable
7. Remote Control

CONNECTION GUIDE

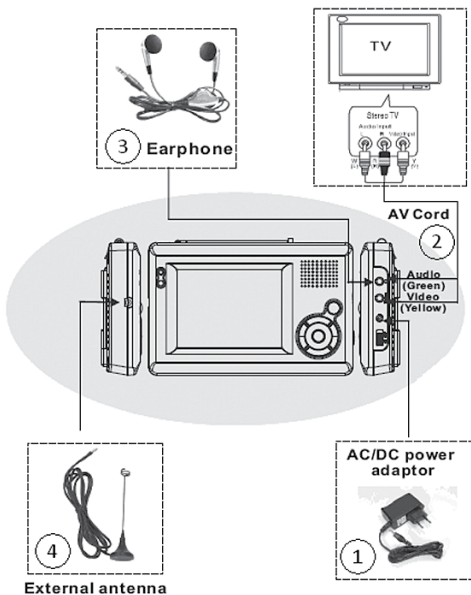

DVBT-C30 User Manual

PREPARING THE BATTERY PACK FOR USE

The battery pack allows the TV to be used with out the AC adaptor

Make sure that the batteries used in the pack are fully charged and are in good condition.

Rechargeable batteries can be used but not charged in this pack.



ATTACHING THE BATTERY PACK

Fit 4 X AA Size batteries to the pack as shown.

Match the batteries to the images in the pack.

Locate the top of the battery pack and hold upwards.

Position the pack on the back of the DVT.

Push the battery pack downwards until the pack locks in place.

Makes sure the pack is locked in place before using the DVT.

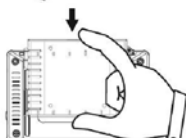
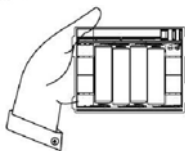
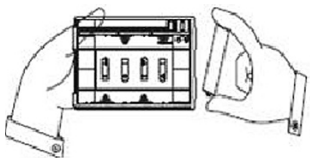

To remove the battery pack from the DVT, locate the locking tab at the top of the pack and press in. Push the pack upwards until tabs are clear of the DVT.

KNOWING YOUR DVT

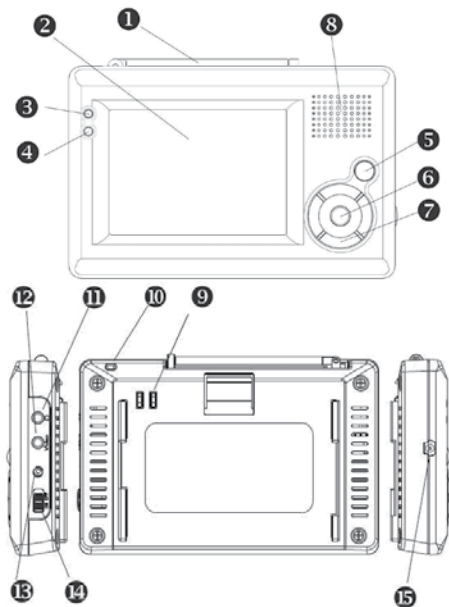

- | | |
|--|--------------------------------------|
| 1 Antenna | 8 Speaker |
| 2 LCD panel | 9 Battery Connector terminal |
| 3 Power LED
(LED will glow green if in use) | 10 Eyelet for lanyard (Not Supplied) |
| 4 IR Sensor | 11 Earphone/Audio out Socket |
| 5 Menu/Exit Button | 12 Video output socket |
| 6 OK/Mute button | 13 DC power connector socket |
| 7 Multi Selector (VOL & Channel) | 14 Power ON/OFF Switch |
| | 15 External Antenna connector |

DVBT-C30 User Manual



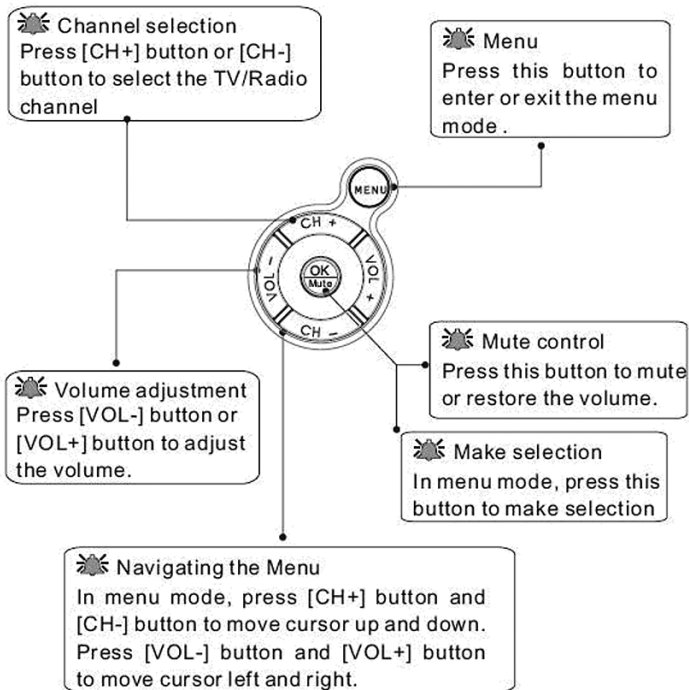















BASIC OPERATION



USING THE MAIN MENU



In the main Menu Mode you can highlight the service type, program list, preview, audio channel, program editing, program info, automatic search, manual search, and system setting to enable the related function. You can use the [CH +], [CH -], [VOL+], and the [VOL -] buttons to navigate around the menu. When the required item is highlighted, press the [OK] button to select.

		Service Type Selection of DVB-TV or DVB-T Radio or FM Radio Program list
		Program List To show the information of all the available channels.
		Preview To Preview up to 9 selected channels
		Audio Channel Selection of either master or secondary language
		Program Editing To arrange the TV channels in the program table via the "Delete", "Skip", or "Reorder" function.
		Program Info To provide the TV program information about the system parameters and signal information
		Automatic Search To search the program channels automatically
		Manual Search To search the program channels manually
		System Settings To configure the system settings. Please see further for detailed information.

DVBT-C30 User Manual

MAIN MENU IN DETAIL

Program List (EPG, Electronic Program Guide)

- 1) In menu mode, select "Program List"
- 2) Press the [OK] button to show all the available channels.
- 3) Press the [CH +] and [CH -] buttons to choose any channel.
- 4) Press the [VOL -] button to show details of the channel
- 5) Press the [Menu] button to exit.



Preview

- 1) In Menu mode select "Preview".
- 2) Press the [OK] button to show 9 channel shots displayed to the right.
- 3) Press [CH +]/[CH -]/[VOL +]/[VOL -] buttons to select the preview and press the [OK] button to watch the channel.
- 4) Press the Menu Button to exit.



Audio

- 1) In Menu mode, select "Audio Channel"
- 2) Press the [OK] button to show the screen as displayed to the right.
- 3) Press the [CH+]/[CH-] buttons to select items.
- 4) Press the [VOL+]/[VOL-] buttons to adjust the setting.
- 5) Press the [MENU] button to exit.



Program Editing

- 1) In menu mode, select "Program Editing"
- 2) Press the [OK] button to show the program edit table.
- 3) Press the [CH+]/[CH-] button to select the channel.
- 4) Press the [VOL+]/[VOL-] button to select the skip channel, delete channel, or move channel sequence function.
- 5) Press the [OK] button to skip channel, delete channel, or change the channel number.
- 6) Press [MENU] button to exit



Program Info

- 1) In menu mode, select "Program Info".
- 2) Press the [OK] button to show the program information.
- 3) Press the [MENU] button to exit



Automatic Search

- 1) In menu mode, select "Automatic Search"
- 2) Press the [OK] button.
- 3) Press the [CH-] to select "OK".
- 4) Press the [OK] button to start the channel search.
- 5) Press [MENU] button to exit



DVBT-C30 User Manual

Manual Search

- 1) In menu mode, select "Manual Search"
- 2) Press the [OK] button to show the manual search screen.
- 3) Press the [VOL-]/[VOL+] button to adjust the Channel
- 4) Press the [CH-] button until the "OK" is highlighted.
- 5) Press the [OK] button to start the target channel Searching.
- 6) Press the [MENU] button to exit.



FM RADIO

Reminder: Ear phones should be connected for better FM reception.

Tuning FM programs

- 1) In menu mode, select "Service Type".
- 2) Press the [OK] to find the FM radio service.
- 3) Press the [Menu] to exit menu mode and enter FM radio mode.
- 4) Press [CH+]/[CH-] to manually search FM programs. Pressing either the [CH+]/ [CH-] buttons for about one second will start the auto channel search.



Turn the Internal Speaker On or OFF

Note: During FM Radio service, plugging the earphone in will automatically turn the internal speaker off. It can be manually turned off as explained below.

- 1) Press [Menu] to toggle between tuning and the radio menu.
- 2) Press [VOL-] to move cursor the "Speaker Output" button.
- 3) Press [OK] to trigger the speaker status. The speaker status indicator under this button will change according to current speaker status.
- 4) Press [CH+] or [Menu] to return to tuning FM station.



Saving Your favourite FM Stations

- 1) Press [Menu] to toggle between tuning and the radio menu.
- 2) Press [CH-] to move the cursor to the "Store" button.
- 3) Press [OK] to activate favourite list.
- 4) Press [CH+]/[CH-] to adjust preferred favourite location.
- 5) Press [OK] to store current frequency to preferred favourite location.



Loading Your favourite FM Stations

- 1) Press [Menu] to toggle between tuning and the radio menu.
- 2) Press [OK] to activate the favourite list.
- 3) Press [CH+]/[CH-] to select a stored favourite location.
- 4) Press [OK] to start hearing selected favourite station or press [Menu] to cancel loading favourites.





















Return to TV Service

- 1) Press [Menu] to toggle between tuning and the radio menu.
- 2) Press [CH-] to move cursor to "Return to TV" button.
- 3) Press [OK] to return to TV service.



DVBT-C30 User Manual

SYSTEM SETTINGS

		Setup Wizard Quickly set up with aid of step by step onscreen instructions.
		Brightness To adjust the screen brightness
		Aspect ratio Changes the aspect ratio of the TV display 16:9 or 4:3
		Subtitle Language Select the subtitle language (if Broadcast)
		Antenna Selection Select the antenna source switch between internal antenna, external antenna or Auto switching.
		TV System Select the required TV system to be displayed. PAL/NTSC/AUTO
		Regional Settings Select the region you are currently located in.
		OSD Language Select the Language of the On Screen Display.
		Time Zone Set the Time zone and local time.

Setup Wizard

- 1) In system setting, select "Setup Wizard"
- 2) Press the [OK] button.
- 3) Press the [VOL+]/[VOL-] button to choose the item.
- 4) Press the [OK] button to select
- 5) Press the [MENU] button to exit

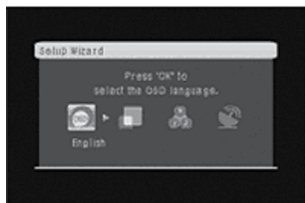

Subtitle Language

- 1) In system setting, select "Subtitle language"
- 2) Press the [OK] button to start the searching
- 3) After the searching, press [CH-]/[CH+] to choose the language.
- 4) Press the [OK] button to select.
- 5) Press the [MENU] button to exit.





Regional Setting

- 1) In system setting, select "Regional Setting"
- 2) Press the [OK] button.
- 3) Press the [CH-]/[CH+]/[VOL+]/[VOL-] button to choose the country.
- 4) Press the [OK] button to select.
- 5) Press the [MENU] button to exit.



DVBT-C30 User Manual

OSD (On Screen Display) language	
<ol style="list-style-type: none">1) In system setting, select "OSD Language".2) Press the [OK] button.3) Press the [CH-]/[CH+] buttons to choose the Language.4) Press the [OK] button to select.5) Press the [MENU] button to exit.	 A screenshot of the OSD Language menu. The title bar at the top says "OSD Language". Below it, a list of languages is shown: "Nederlands", "English" (highlighted with a grey bar), "Suomi", "Français", "Deutsch", "Italiano", "Portugués", and "Español".
Brightness	
<ol style="list-style-type: none">2) Press the [OK] button.3) Press the [VOL+]/[VOL-] buttons to adjust the brightness level of the display.4) Press the [OK] button to select.5) Press the [MENU] button to exit.	 A screenshot of the Brightness adjustment menu. The title bar at the top says "Brightness". Below it is a horizontal slider with three circular indicators in the middle. There are left and right arrow buttons on either side of the slider.
Time Zone	
<ol style="list-style-type: none">1) In system setting, select "Time Zone".2) Press the [OK] button.6) Press the [VOL+]/[VOL-] buttons to adjust the time.7) Press the [OK]/ [MENU] button to select.	 A screenshot of the Brightness adjustment menu, identical to the one above. The title bar at the top says "Brightness". Below it is a horizontal slider with three circular indicators in the middle. There are left and right arrow buttons on either side of the slider.

QUICK SETUP

There are two ways to setup the start the instillation wizard.

I. Press the [OK] button for 5 seconds

- 1) After pressing the [OK] button for 5 seconds, the unit will be re-started and display the message shown right.
- 2) Press the [VOL-] button to select "OK" item
- 3) The "Setup Wizard" will be shown.
- 4) Set the OSD Language, Region, Time Zone, and then start the automatic search.
- 5) When all stations are detect the Setup Wizard is complete.

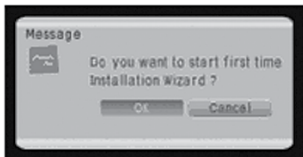

II. Go to the main Menu -> System Setting -> Setup Wizard

- 1) Set the OSD Language, Region, Time Zone, and then start the automatic search.
- 2) When all stations are detect the Setup Wizard is complete.

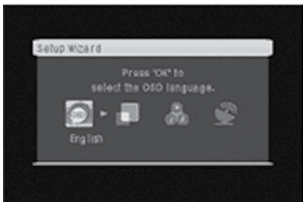

DVBT-C30 User Manual

CONNECTING TO A TV SET

Please familiarise your self with the manual of any equipment you plan to connect this device to. Ensure that the power is off on equipment you are connecting this device to before connecting it.

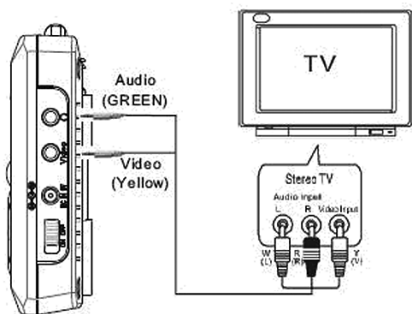

Notice

Do not connect this device through a Video Cassette Recorder, VD recorder or PVR when setting up your home entertainment system. Picture may not be displayed correctly because of Copy Protection signals embedded in the TV signal. If your TV set does not have the correct A/V inlet plugs it may be necessary to source an RF Modulator through your Local Electronics store.

TROUBLE SHOOTING Q & A

Most of the troubleshooting issue can be easily solved. The common cases and the respective solutions are listed in the table below. If the problem is not listed or not shown below please contact technical support.

Problem	Possible reason	Solution
No Picture, No Audio	The Batteries are totally discharged.	Replace batteries with new ones
	The power cable is properly connected to the device.	Check the power lead connection. Confirm that the adaptor has power.
	The Device is not switched on.	Slide the "Power Switch" to the "ON" position.
The number of DVB-T channels is not was expected	The number of available channels is limited to the number of channels broadcast in a given area.	Perform "Auto Search" or "Manual Search" to rescan all channels.
	The signal quality of some channels is too low	Use the external antenna to increase the reception sensitivity. For Indoor use, place the antenna on a high point close to a window.
	Some TV channels are not available	Only the locally broadcast channels can be viewed. They can differ from area to area.
All channels show "No Signal" or random mosaic tiles appear on the display.	Some TV channels signal quality is too low.	Use the external antenna to increase the reception sensitivity. For Indoor use, place the antenna on a high point close to a window
	Wrong antenna is used	Use only the external antenna provided with this device
	No DVB-T service is provided in the area	Check the DVB-T coverage in your area.
The video is fine but there is no sound	The volume is too low	Click the "VOL +" button to raise the volume
	The audio is muted	Click the "MUTE" button to disable the mute function.
The power LED is flashing.	The battery power is too low	Connect the TV to an external power source or replace the batteries

DVBT-C30 User Manual

SPECIFICATIONS

Display	•	3.5" COLOUR TFT-LCD 320(W)x 240(H)
Antenna	•	Built-in telescopic antenna for UHF band reception
Speaker	•	Built-in 0.5W/8 Ω speaker
Video Output	•	3.5mm Video out socket
Audio Output	•	3.5mm Stereo Audio out / Earphone socket
Controls	•	6 button thumb pad + Power ON/OFF slide switch
OSD Languages	•	English, German, French, Portuguese, Spanish, Italian, Dutch
Features	•	DVB-T TV/Radio, FM Radio. Auto channel search, EPG, Channel preview, Teletext & Subtitles where broadcast.
Power supply	•	100/240V AC power adaptor. Output = 5VDC @1.4amps
Battery	•	4 x AA batteries (not Supplied)
Operating time	•	Typically up to 3.5hrs operation time.
Dimensions	•	134mm X 87mm X 22mm (Not including battery pack)
Weight	•	195grams (Not including battery pack)
Technical support	•	www.LaserCo.net