

# COLOR LCD GPS/WAAS PLOTTER

with integral DGPS Receiver and Echo sounder

Models GP-1650W/1650WD/1650WF/1650WDF

- High-accuracy GPS/DGPS/WAAS receiver
- 6" AR-coated high-contrast bright LCD for optimum viewing under direct sunlight
- Display of ship's track, waypoints and planned route on a precision electronic chart
- Works with FURUNO MiniChart or NAVIONICS® Nav-Chart™ and C-MAPNT Chart
- Versatile display modes including:
  - Course Plot
  - Nav Data
  - Steering Display
  - Highway
- Course plot in True Motion North-up/ Course-up or Relative Motion North-up/Course-up
- Automatic or manual selection either WAAS, DGPS or GPS (GP-1650WD/1650WDF)
- Built-in DGPS beacon receiver with GPS/DGPS combo antenna (GP-1650WD/1650WDF)
- 50/200 kHz, 600 W dual-frequency echo sounder (GP-1650WF/1650WDF)
- Waterproof display suited for flybridge installation



Photo: Model GP-1650WDF (Navionics® Nav-Chart™)

- GP-1650W:** GPS/WAAS plotter
- GP-1650WD:** GPS/WAAS plotter with DGPS beacon receiver
- GP-1650WF:** GPS/WAAS plotter with echo sounder
- GP-1650WDF:** GPS/WAAS plotter with DGPS beacon receiver and echo sounder

For all boaters...

FURUNO GP-1650 series offer Accurate Positioning with WAAS, High Contrast Bright LCD for optimum viewing under the direct sun light



Compact sensitive GPS/DGPS antenna



GPS/DGPS /WAAS combo antenna



Navionics® Nav-Chart™



Choose from two units that accept either Furuno MiniChart and Navionics® Nav-Chart™ or C-MAPNT Charts.



## WAAS (Wide Area Augmentation System)

WAAS is a GPS navigation system with differential correction by means of geostationary satellites. The US FAA has been testing this system and expects more field tests in 2003. Similar systems, using Satellite-Based Augmentation Systems (SBAS), are under development in Japan (MSAS: MSAT Satellite-based Augmentation System) and Europe (EGNOS: European Geostationary Navigation Overlay System). They are said to be fully interoperable and compatible. MSAS and EGNOS are expected to become fully operational in 2004 or after.

As the WAAS utilizes the same frequency as the GPS, a single antenna can receive GPS and WAAS signals. Currently two Inmarsat GEO satellites are available for receiving the WAAS signal: AOR-W and POR. Major contributors of an error in a single frequency GPS system are receiver clock drift and signal delays by refraction. The WAAS reference stations on the earth monitor the GPS constellation and route GPS error data to the satellites via the master earth station. The Inmarsat or communication satellite broadcasts the differential corrections to marine and aviation users.

The GP-1650W series are GPS/DGPS/WAAS plotters with video plotting and echo sounding capability designed for pleasure craft and coastal fishing boats. This compact and cost-effective series offers extremely accurate position fixes - 10 m for the basic GPS, 3 m where WAAS service is available and 5 m with DGPS (DGPS version).

The Display modes include Course Plot, Nav Data, Steering and Highway. The Steering mode provides an intuitive indication of course to steer and cross-track-error. The Highway mode is useful when you are following a series of waypoints along a planned route.

The GP-1650WF and GP-1850WDF with the 50/200 kHz echo sounder module present detailed information on fish and bottom. The echo sounder data can be displayed jointly with course plot or alone on the full size screen.

The useable chart cards are Furuno MiniChart/ Navionics® Nav-Chart™ or C-MAPNT Chart cards. Chart cards contain accurate spot sounding, coastlines, depth contours, buoys, lighthouses and other navigational features.

## PRIMARY DISPLAY MODES



C-MAPNT Chart

### Course plot

Choice of TM North-up or Course-up and RM North-up or Course-up mode.

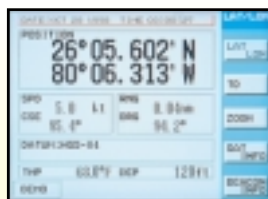

### Nav Data

Most important navigational information can be clearly read from a distance.

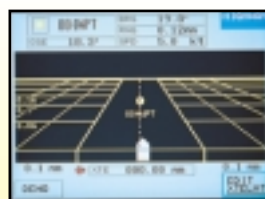

### Highway

Useful for following legs or segments of a planned route.

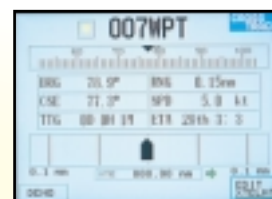

### Steering mode

Assists the vessel in following intended course.

## ECHO SOUNDER DISPLAY MODES (GP-1650WF/1650WDF)

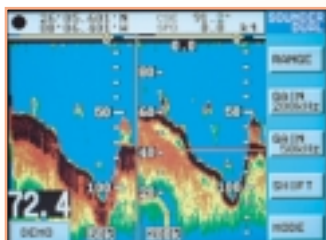

### Dual frequency

Incorporating a powerful 50/200 kHz, 600 W echo sounder module, the GP-1650WF/1650WDF present an echogram in addition to the course plot display. Full-screen echo sounding modes include Normal (single- or dual-freq), Bottom-lock, Bottom Zoom, Marker Zoom and A-scope.



### A-scope (at right)

Selection of sounding range, phasing, gain, display mode, frequency and other settings are simple with the softkeys at the right of the screen. A water temperature graph can be displayed if an appropriate temperature sensor is provided.

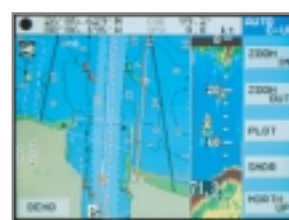

C-MAPNT Chart

### Course plot + Sounder

## COURSE PLOT DISPLAY MODES

Four chart orientations are available in the course plot display: True Motion North-up, Course-up and Relative Motion North-up and Course-up modes. In the True Motion modes, coastlines remain stationary on the screen while your vessel moves according to its actual speed and course. In the Relative Motion mode, your vessel stays kept at the screen center and coastlines move relative to your vessel.



C-MAPNT Chart

### TM North-up mode



C-MAPNT Chart

### RM North-up mode



Navionics® Nav-Chart™

### TM Course-up mode (Automatic)

The course plot display shows your ship's position with a motion trend vector, route, position, speed and course. Your ship's heading and speed are indicated by a vector at your present position. Display colors can be changed for optimum visibility depending on ambient light conditions.

In the Auto Course-up mode, automatic resetting takes place at a course change of 22.5° and the ship's intended course is kept at the screen top like a head-up display.

# SPECIFICATIONS OF GP-1650W/1650WD/1650WF/1650WDF

## GPS RECEIVER CHARACTERISTICS

1. **Receiver Type** Twelve discrete channels, C/A code, all-in-view integral WAAS processor
2. **Receive Frequency** L1 (1575.42 MHz)
3. **Accuracy** GPS: 10 m (95%)  
DGPS: 5 m (95%)  
WAAS: 3 m (95%)
4. **Time to First Fix** 12 seconds typical (Warm start)
5. **Tracking velocity** 999 knots
6. **Geodetic System** WGS-84, NAD-27, and others
7. **DGPS Capability**  
GP-1650WD/1650WDF: DGPS beacon receiver built in  
GP-1650W/1650WF: External DGPS beacon receiver transmitting data in RTCM SC104 v.2.1 format through RS-232C interface or optional internal DGPS beacon receiver

## PLOTTER CHARACTERISTICS

1. **Display** 6 inch color LCD, 320 x 234 pixels
2. **Map Scale** 0.125 to 2,048 nm
3. **Latitude Limits** Between 85°N and 85°S
4. **Plot Interval** 1 s to 99 min 59 s or 0.01 to 9.99 nm
5. **Display Modes** Course plot, Nav Data, Steering Display, Highway
6. **Presentation Modes** TM/RM North-up, Course-up
7. **Memory Capacity** Up to 5,000 points for ship's track and marks  
800 waypoints and 200 planned routes  
(Max. 35 waypoints/route)
8. **Voyage Planning** Waypoint navigation or route navigation
9. **Alarms** Arrival/anchor watch, XTE, proximity alert, ship speed, depth\*, water temperature\*, fish\*

\*For GP-1650WF/1650WDF—Temperature sensor required for water temp alarm.

10. **Nav Data Inputs/Outputs** (NMEA 0183 ver. 1.5/2.0) --: any talker **Outputs:**

AAM, APB, BOD, BWC, GGA, GLL, RMA, RMB, RMC, VTG, WPL, XTE, ZDA, DBT\*, DPT\*, MTW\*, MSK

### Inputs:

DBT\*, DPT\*, MTW\*, TLL, YMWPL (YEOMAN wpt data)

\*GP-1650WF/1650WDF

11. **Electronic Chart** FURUNO MiniChart or NAVIONICS® Nav-Chart™ and C-MAPNT Chart

## ECHO SOUNDER

1. **Display Modes** Normal (single- or dual-frequency), Bottom-lock, Bottom Zoom, Marker Zoom, A-scope
2. **Frequency** 50 and 200 kHz (selectable on menu)
3. **Output Power** 600 W (rms)
4. **Basic Ranges** 8 basic ranges customized to max 800 m. (2500 ft, 400 fa)
5. **Range Phasing** Up to 1600 m (5000 ft, 800 fa)

## ENVIRONMENTAL CONDITIONS

1. **Temperature** (IEC 60945 testing)  
Display unit: -15°C to +55°C  
Antenna unit: -25°C to +70°C
2. **Water Resistance**  
Display unit: IPX5 (IEC 60529), CFR46 (USCG)  
Antenna unit: IPX6 (IEC 60529), CFR46 (USCG)

## POWER SUPPLY

12 - 24 VDC, GP-1650W/WD: 13.5 W, GP-1650WF/WDF: 16.5 W

## EQUIPMENT LIST

- |  |        |
|--|--------|
| <b>Standard</b>  |        |
| 1. Display unit  | 1 unit |
| 2. Antenna unit with 10 m cable  | 1 unit |
| 3. NMEA cable 5 m  | 1 pc.  |
| 4. Installation Materials and Standard Spare Parts   | 1 set  |
| <b>Optional</b>  |        |
| 1. FURUNO MiniChart Card   |        |
| 2. NMEA cable 10 m   |        |
| 3. Antenna mounting base<br>13-QA330 (Pipe mount), 13-QA310 (Offset bracket), 13-RC5160 (Handrail mount) |        |

4. Rectifier PR-62 for 115/230 VAC mains
5. Temperature Sensor T-02MTB/T-02MSB/T-03MSB (GP-1650WF/GP-1650WDF)
6. Speed/Temperature Sensor ST-02MSB/ST-02PSB (GP-1650WF/GP-1650WDF)
7. Internal DGPS beacon receiver kit for GP-1650W/GP-1650WF
8. Connector kit for connecting temp or speed/temp sensor
9. RAM card

### Transducers (Specify when ordering GP-1650WF/1650WDF.)

1. 520-5PSD (Plastic thru-hull)
2. 520-5MSD (Bronze thru-hull)
3. 520-5PWD (Plastic transom)
4. 525ST-MSD (Bronze thru-hull with speed/temp sensor)
5. 525ST-PWD (Plastic transom with speed/temp sensor)

### GPS/WAAS ANTENNA

**GPA-017**  
(10 m cable attached)

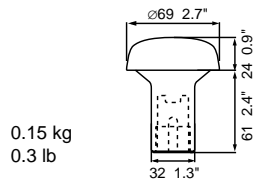

0.15 kg  
0.3 lb

### DGPS/WAAS ANTENNA

**GPA-019**  
(10 m cable attached)

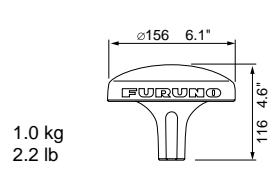

1.0 kg  
2.2 lb

## DISPLAY UNIT

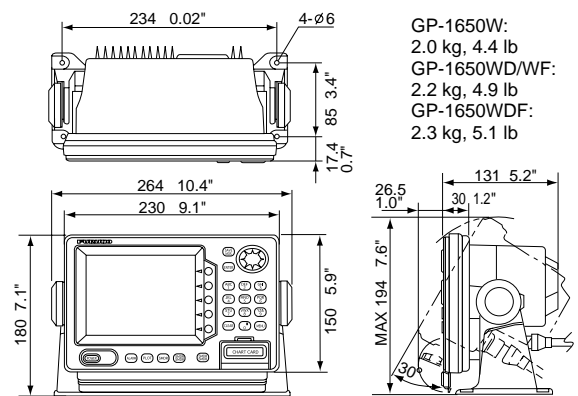

GP-1650W:  
2.0 kg, 4.4 lb  
GP-1650WD/WF:  
2.2 kg, 4.9 lb  
GP-1650WDF:  
2.3 kg, 5.1 lb

## INTERCONNECTION DIAGRAM

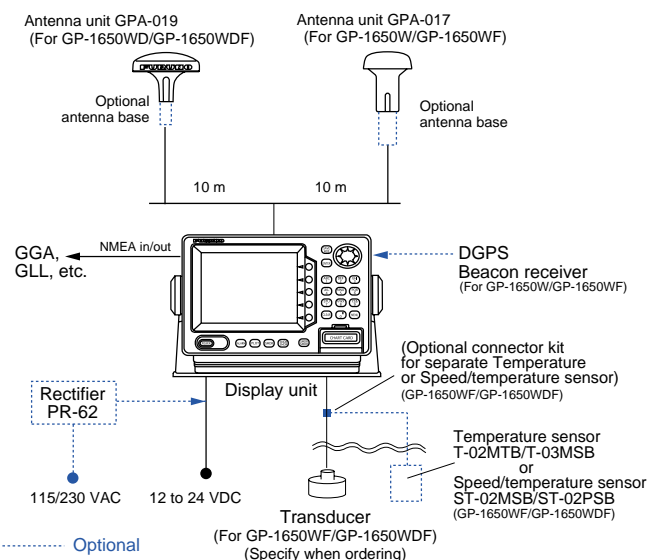

SPECIFICATIONS SUBJECT TO CHANGE WITHOUT NOTICE

**FURUNO U.S.A., INC.**  
Camas, Washington, U.S.A.  
Phone: +1 360-834-9300 Telefax: +1 360-834-9400

**FURUNO (UK) LIMITED**  
Denmead, Hampshire, U.K.  
Phone: +44 2392-230303 Telefax: +44 2392-230101

**FURUNO FRANCE S.A.**  
Bordeaux-Mérignac, France  
Phone: +33 5 56 13 48 00 Telefax: +33 5 56 13 48 01

**FURUNO ESPANA S.A.**  
Madrid, Spain  
Phone: +34 91-725-90-88 Telefax: +34 91-725-98-97

**FURUNO DANMARK AS**  
Hvidovre, Denmark  
Phone: +45 36 77 45 00 Telefax: +45 36 77 45 01

**FURUNO NORGE A/S**  
Ålesund, Norway  
Phone: +47 70 102950 Telefax: +47 70 127021

**FURUNO SVERIGE AB**  
Västra Frölunda, Sweden  
Phone: +46 31-7098940 Telefax: +46 31-497093

**FURUNO SUOMI OY**  
Helsinki, Finland  
Phone: +358 9 341 7570 Telefax: +358 9 341 5716

02095T Printed in Japan